

CONTEMPORARY

BERLIN

WENGE, TEXTURE [WAVE]



Textured Wenge Doors

Brown Speaker Grill

Hidden Adjustable Leveler



BERLIN

WENGE. TEXTURE [WAVE]

CONTEMPORARY

CHAMELEON COLLECTION



Berlin 217 23.25"W x 21.5"H x 21.25"D
 Single Cabinet | C/BL217/WE
 Subwoofer Enclosure | C/BL217SE/WE



Berlin 317 23.25"W x 31.25"H x 21.25"D
 Single Cabinet | C/BL317/WE
 Rack Mount Cabinet | C/BL317RM/WE

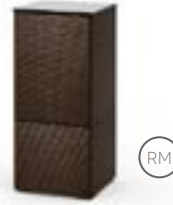

Berlin 517
 Single Cabinet | C/BL517/WE
 Rack Mount Cabinet | C/BL517RM/WE



Berlin 617 23.25"W x 60.625"H x 21.25"D
 Single Cabinet | C/BL617/WE
 Rack Mount Cabinet | C/BL617RM/WE



Berlin 221 44"W x 21.5"H x 21.25"D
 Twin Cabinet | C/BL221/WE



Berlin 221 Corner 44"W x 21.5"H x 21.25"D
 Twin Corner Cabinet | C/BL221/CR/WE



Berlin 329 44"W x 31.25"H x 21.25"D
 Twin Cabinet | C/BL329/WE



Berlin 329 Corner 44"W x 31.25"H x 21.25"D
 Twin Corner Cabinet | C/BL329/CR/WE



Berlin 323 44"W x 31.25"H x 21.25"D
 Twin Cabinet | C/BL323/WE
 Rack Mount Cabinet | C/BL323RM/WE



Berlin 323 Corner 44"W x 31.25"H x 21.25"D
 Twin Corner Cabinet | C/BL323CR/WE



Berlin 236 64.75"W x 21.5"H x 21.25"D
 Triple Cabinet | C/BL236/WE



Berlin 237 64.75"W x 21.5"H x 21.25"D
 Triple Cabinet | C/BL237/WE



Berlin 336 64.75"W x 31.25"H x 21.25"D
 Triple Cabinet | C/BL336/WE



Berlin 337 64.75"W x 31.25"H x 21.25"D
 Triple Cabinet | C/BL337/WE



Berlin 339 64.75"W x 31.25"H x 21.25"D
 Triple Cabinet | C/BL339/WE



Berlin 245 85.5"W x 21.5"H x 21.25"D
 Quad Cabinet | C/BL245/WE



Berlin 247 85.5"W x 21.5"H x 21.25"D
 Quad Cabinet | C/BL247/WE



Berlin 345 85.5"W x 31.25"H x 21.25"D
 Quad Cabinet | C/BL345/WE



Berlin 347 85.5"W x 31.25"H x 21.25"D
 Quad Cabinet | C/BL347/WE

CR - Corner
 RM - Rack Mount, Pro Audio
 SUB - Subwoofer Enclosure
 W - Wall Mountable

 Speaker Integration



INTERIOR SPECIFICATIONS

A - Single-Width Compartment

19.75"W x 19.5"D x 17.75"H

B - Single-Width Compartment

19.75"W x 19.5"D x 27.75"H

C - Media Drawer

18.625"W x 18"D x 7.75"H

holds 75 DVD's and or 111 CD's upright

D - Single-Width Center Speaker / Multi-Functional Compartment

19.75"W x 19.5"D x 9"H

G - Double-Width Center Speaker / Multi-Functional Compartment

40.5"W x 19.5"D x 9"H

F - Triple-Width Center Speaker / Multi-Functional Compartment

61.25"W x 19.5"D x 9"H

J - Double-Width Compartment

40"W* x 19"D* x 17.5"H

H - Double-Width Compartment

40"W* x 19"D* x 27.75"H



217
SUBWOOFER ENCLOSURE
Includes Rear Speaker Grill



217
Rec. TV Size: up to 32"
Top Holds: 150 lbs

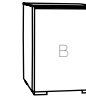

317
Rec. TV Size: up to 32"
Top Holds: 150 lbs

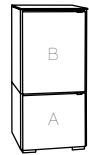

517
Rec. TV Size: up to 32"
Top Holds: 150 lbs

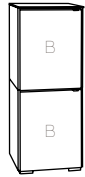

617
Rec. TV Size: up to 32"
Top Holds: 150 lbs

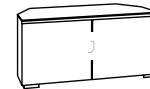

212 CORNER
Top Holds: 150 lbs

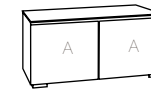

221
Rec. TV Size: up to 46"
Top Holds: 150 lbs

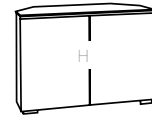

323 CORNER
Top Holds: 150 lbs

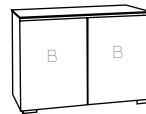

323
Rec. TV Size: up to 46"
Top Holds: 150 lbs

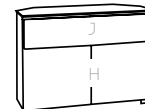

329 CORNER
Top Holds: 150 lbs

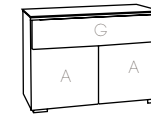

329
Rec. TV Size: up to 32"
Top Holds: 150 lbs

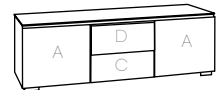

236
Rec. TV Size: up to 32"
Top Holds: 150 lbs

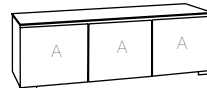

237
Rec. TV Size: up to 65"
Top Holds: 150 lbs

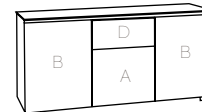

336
Rec. TV Size: up to 65"
Top Holds: 150 lbs

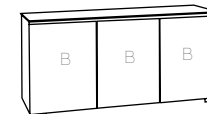

337
Rec. TV Size: up to 65"
Top Holds: 150 lbs

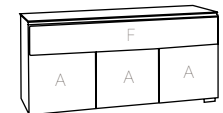

339
Rec. TV Size: up to 65"
Top Holds: 150 lbs

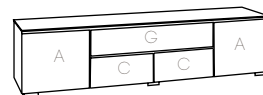

245
Rec. TV Size: up to 70"+
Top Holds: 150 lbs

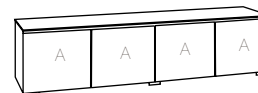

247
Rec. TV Size: up to 70"+
Top Holds: 150 lbs

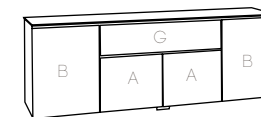

345
Rec. TV Size: up to 70"+
Top Holds: 150 lbs

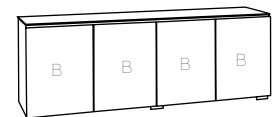

347
Rec. TV Size: up to 70"+
Top Holds: 150 lbs

INTERIOR SPECIFICATIONS

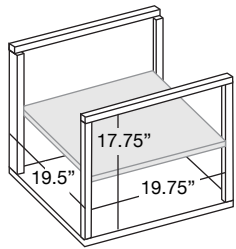

A

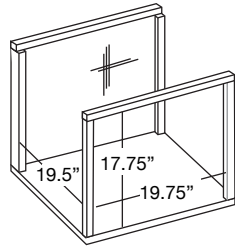

A1

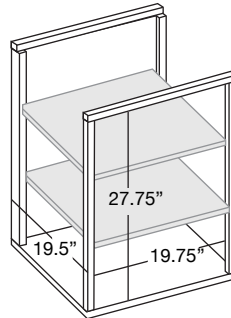

B

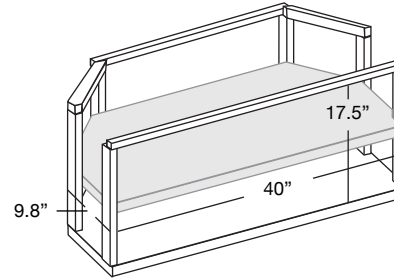

J

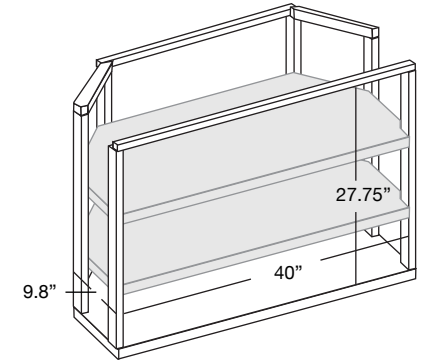

H

CORNER INTERIOR

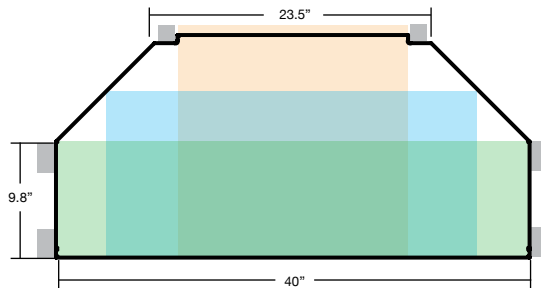

- 40" wide x 10" deep
- 32" wide x 14" deep
- 19" wide x 20" deep

CORNER EXTERIOR

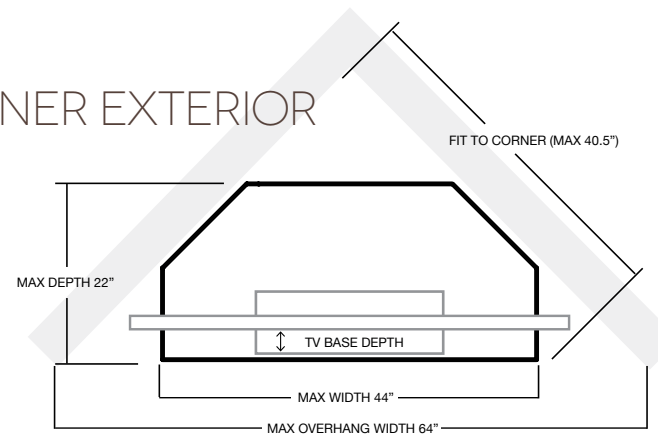

TV SIZING:

For every 1" of depth required by the TV base, subtract 1.8 from 64. This is the MAX TV width at the required depth. Note: Minor gains can be had by moving cabinet forward. This will cause a gap but will produce 1.8" in width per inch moved forward.