



eureka® | Swan

# Cordless Vacuum **HYPER CLEAN**

Model: SC15820N

Help line: 0333 220 6050

v1.1





**Follow caution information wherever you see this symbol.**

When using an electrical appliance, basic precautions should always be followed, including the following:

**READ ALL INSTRUCTIONS BEFORE USING THIS VACUUM CLEANER**

Failure to follow the warnings and instructions may result in electric shock, fire and/or serious injury.

## WARNING

- Prevent unintentional starting. Ensure the switch is in the off-position before connecting to battery pack, picking up or carrying the appliance. Carrying the appliance with your finger on the switch or energizing appliance that has the switch on invites accidents.
- Do not touch nozzle when the vacuum cleaner is on. Danger.
- Do not put any object into openings. Do not use with any openings blocked; keep free of dust, lint, hair and anything that may reduce air flow.
- Do not use outdoors or on wet surfaces.
- Do not operate the vacuum cleaner or charger if it has been damaged in any way. If vacuum cleaner is not working as it should, has been dropped, damaged, left outdoors, or dropped into water, call the Eureka | Swan Customer Service HELP LINE at 0333 220 6050
- To avoid excessive heat and damage to the unit or battery, the vacuum cleaner will not operate while charging.
- Do not allow to be used as a toy. Close attention is necessary when used by or near children.
- Use only as described in this manual. Use only manufacturer's recommended attachments.
- Recharge only with the charger specified by the manufacturer. A charger that is suitable for one type of battery pack may create a risk of fire when used with another battery pack.
- Do not pull or carry the charger by cord, use cord as a handle, close a door on cord, or pull cord around sharp edges or corners. Do not run appliance over cord. Keep cord away from heated surfaces.

- This charger is not intended for use by travellers.
- Do not use extension cords or outlets with inadequate current-carrying capacity for the charger.
- Do not unplug by pulling on cord. To unplug, grasp the plug, not the cord.
- Do not handle charger or vacuum cleaner with wet hands.
- Use appliances only with specifically designated battery packs. Use of any other battery packs may create a risk of injury and fire.
- **DO NOT MUTILATE OR INCINERATE BATTERIES. THEY BECOME DANGEROUS AT HIGH TEMPERATURES.**
- Liquid ejected from the battery may cause irritation or burns. If the liquid gets on the skin, (1) seek medical attention, (2) wash quickly with soap and water, and (3) neutralize with a mild acid such as lemon juice or vinegar. If the liquid gets into the eyes, flush them immediately with clean water for a minimum of 10 minutes.
- When battery pack is not in use, keep it away from other metal objects, like paper clips, coins, keys, nails, screws or other small metal objects, that can make a connection from one terminal to another. Shorting the battery terminals together may cause burns or a fire.
- This product has a functioning temperature range within 5°C - 40°C.
- Do not use a battery pack or appliance that is damaged or modified. Damaged or modified batteries may exhibit unpredictable behaviour resulting in fire, explosion or risk of injury.
- Do not expose a battery pack or appliance to fire or excessive temperature. Exposure to fire or temperature above 130°C may cause explosion.
- Follow all charging instructions and do not charge the battery pack or appliance outside of the temperature range specified in the instructions. Charging improperly or at temperatures outside of the specified range may damage the battery and increase the risk of fire.

- Have servicing performed by a qualified repair person using only identical replacement parts. This will ensure that the safety of the product is maintained.
- Do not modify or attempt to repair the appliance or the battery pack except as indicated in the instructions for use and care.
- The terminals on both the vacuum cleaner and battery should be kept free and clean of objects. Do not insert metal objects inside the terminals.
- This vacuum cleaner creates suction. Keep hair, loose clothing, fingers, and all parts of body away from openings and moving parts.
- Do not pick up anything that is burning or smoking, such as cigarettes, matches, or hot ashes.
- Do not use without filters in place.
- Use extra care when cleaning stairs.
- Do not use to pick up flammable or combustible liquids, such as gasoline/petrol, or use in areas where they may be present.
- Store vacuum cleaner and charger indoors in a cool, dry area. To avoid electric shock and/or cleaner damage, do not expose to weather elements.
- Keep your work area well lit. Unplug electrical appliances before vacuuming them.
- Overcharging, short circuiting, reverse charging, mutilating or incinerating the cells and the batteries must be avoided.
- If a cell or a battery has leaked or vented, it should be replaced immediately using protective gloves.
- If and when necessary, these cells or batteries must be replaced with identical new ones from the same manufacturer. If a cell or a battery to be replaced is connected with other cells or batteries in series, it is recommended that the other cells or batteries be replaced with new ones at the same time.
- Reverse polarity installation of the cell or the battery in the end product must be avoided.

- Do not incinerate this appliance even if it is severely damaged. Contact local waste facility before discarding in trash.
- This appliance can be used by children aged from 8 years and above if they have been given supervision or instruction concerning use of the appliance in a safe way and if they understand the hazards involved. Cleaning and user maintenance shall not be made by children unless they are older than 8 and supervised. Keep the appliance and its cord out of reach of children aged less than 8 years.

## SAVE THESE INSTRUCTIONS

Carefully unpack and inspect your new Eureka | Swan vacuum cleaner for shipping damage.

Each unit is tested and thoroughly inspected before shipping. For instructions regarding any shipping damage, call the Eureka | Swan Customer Service HELPLINE at 0333 220 6050 immediately.

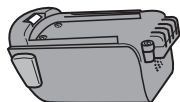

Battery

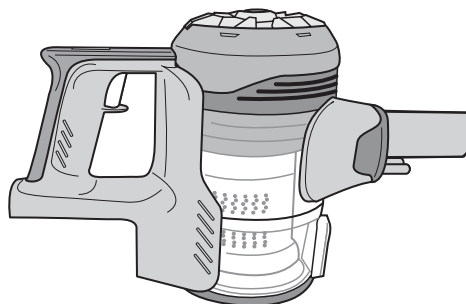

Hand vacuum

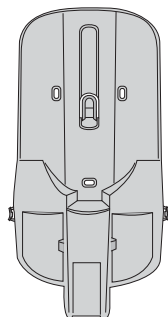

Wall mount charging base

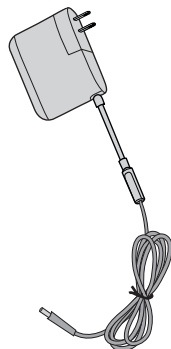

Charger



Wand

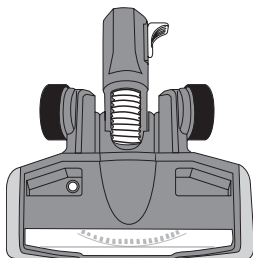

Hyper Head

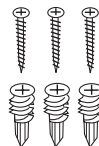

3 screws & wall plugs

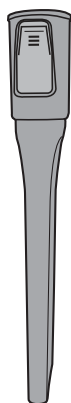

Crevice tool

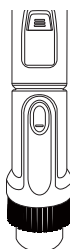

2-in-1 upholstery tool

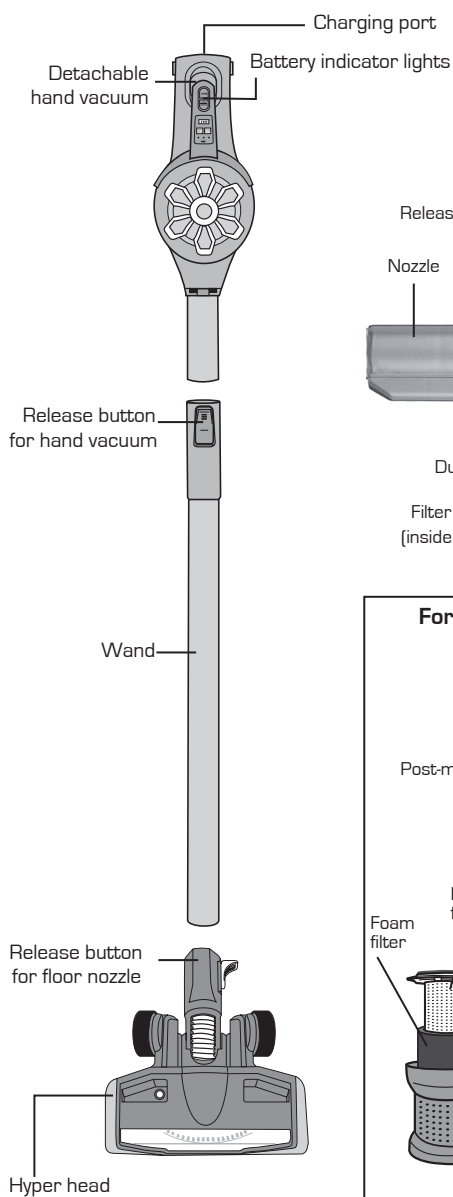

### Hand vacuum

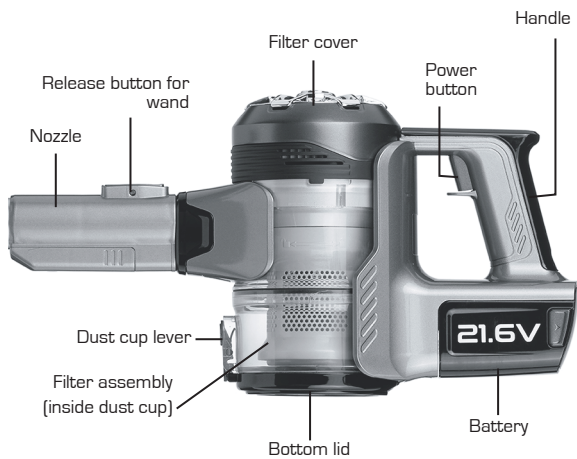

For filter maintenance instructions, see below

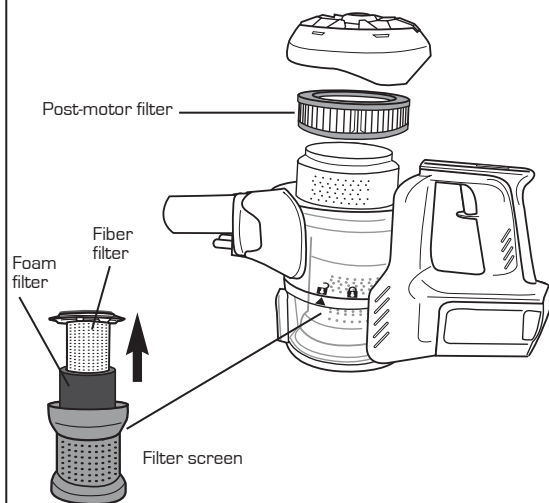

1. Slide battery onto hand vacuum until firmly attached (Fig. 1).
2. Slide wand onto hand vacuum until it clicks (Fig. 2).
3. Push wand into motorized floor nozzle until it clicks (Fig. 3).

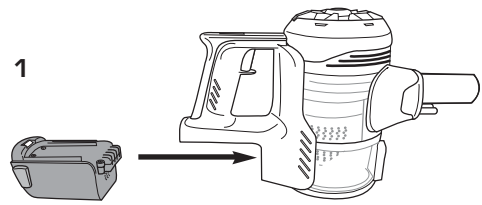

**How to install wall mount**

- Choose location near power outlet. Locate point high enough on wall to allow wand and motorized floor nozzle to hang freely.
- Place mount against wall and use pencil to mark drill holes.
- Drill holes (with 6mm bit) and insert all plugs. Insert screws through holes on mount and tighten until firmly attached (Fig. 4).

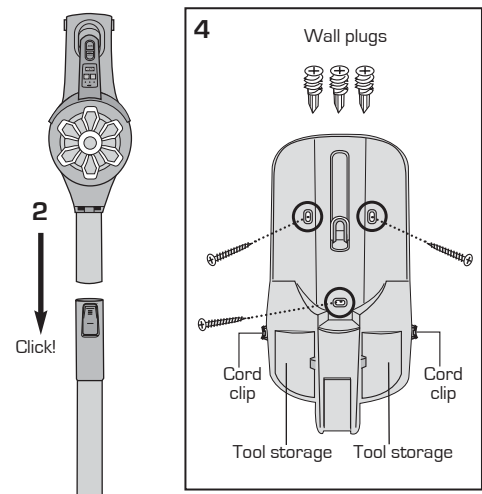

**How to charge battery and store accessories**

- Place assembled vacuum cleaner on wall mount.
- Plug charger into power outlet and then into charger port on handle (Fig. 5).
- Loop charger cord into clips on sides of wall mount.
- Snap tool(s) into tool storage areas (Fig. 5).

**Battery indicator lights show level of charge (Fig. 5):**

- A. Fully charged
- B. Half charged
- C. Low power

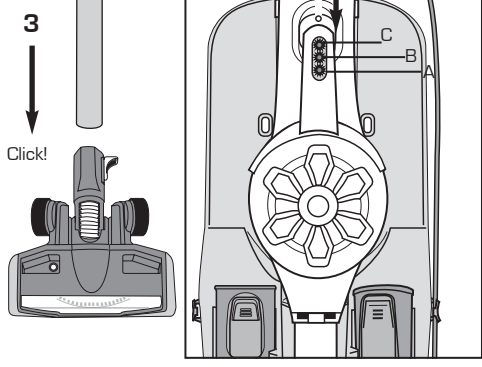

- Indicator lights stop blinking when fully charged.
- Charge battery fully before using for the first time. This may take up to four hours.





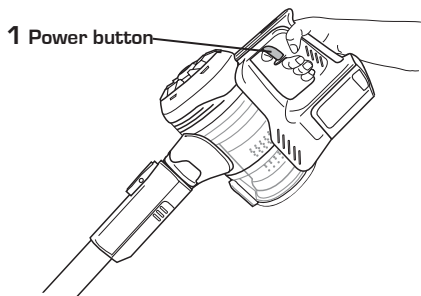

## How to use cleaner for cleaning floors

1. Click power button once to start (Fig. 1).
2. Using motorized floor head or plush brush roll (SC15822N only), glide back and forth on area to be cleaned. Avoid oversized or sharp items (such as screws) with cleaner.
3. Twist wrist to engage swivel function.
4. When done, click power button once to stop motor.



Empty dust cup after every use

There are two ways to empty the dust cup:

1. Hold cleaner over waste basket. Press lever to release bottom lid of dust cup to empty debris (Fig. 2).
2. Or, remove dust cup from hand vacuum by twisting to 'unlock'  position (Fig. 3). Once emptied, reattach dust cup by lining up arrow  and 'unlock'  position. Twist dust cup until arrow  lines up with 'locked'  position.

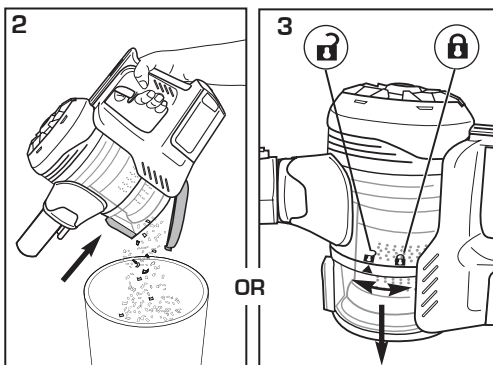

## How to use hand vacuum and accessories



### CAUTION

**Moving parts!** Always turn off hand vacuum before attaching accessories

The hand vacuum can be used with or without tools.

- To use without tools, press release button and remove wand. Collect debris directly with hand vacuum nozzle (Fig. 4).
- To use tools with wand, press release button to remove motorized floor nozzle. Slide tool onto end of wand until it clicks (Fig. 5).
- To use tools with hand vacuum only, press release button to remove wand. Slide tool onto hand vacuum until it clicks.

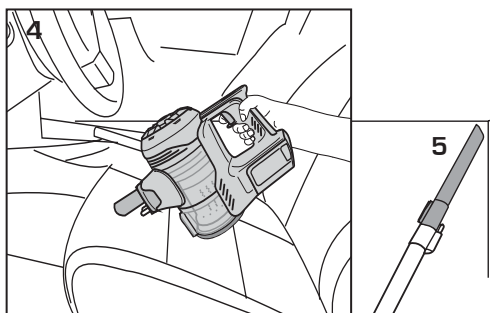

### Crevice tool:

Cleans hard-to-reach areas such as corners, baseboard edges, dryer vents, chairs and sofas.

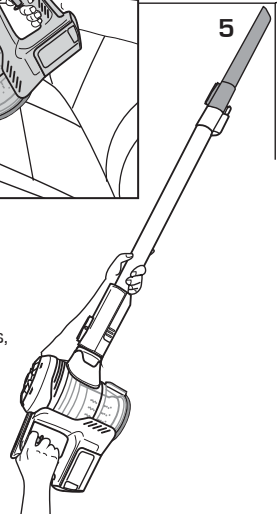

## How to use hand vacuum and motorized floor head/plush brush roll

Ideal for cleaning stairs.

- Press release button to remove wand from hand vacuum. Attach Hyper-clean head directly to hand vacuum until it clicks.
- Click power button once to start.



Use with or without wand.

- **2-in-1 upholstery tool:** Use brush to vacuum blinds, vents or upholstered surfaces. Use felt portion to clean delicate surfaces. To switch between felt and brush portions, press thumb release and slide brush up or down.



**CAUTION**

Never operate vacuum cleaner without all filters, filter screen and dust cup in proper position.

**WARNING:** Moving parts!

Recharge cleaner after each use.

Dust cup – Empty after each use



Hold over wastebasket and push lever to release bottom lid. Debris will empty.

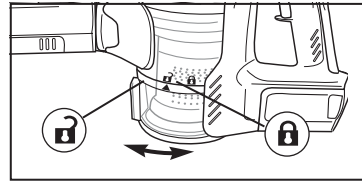

Or, remove dust cup by twisting to 'unlock' position. Empty debris. Reattach dust cup and twist to 'lock' position.

Washable dust cup filter – clean monthly

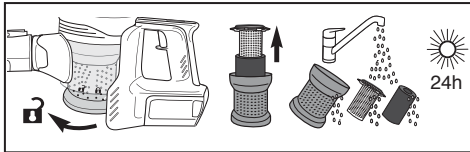

1. Twist dust cup and remove.
2. Twist filter screen and remove.
3. Lift out foam filter and holder.
4. Separate foam filter from fiber filter by pulling them apart.
5. Rinse and dry THOROUGHLY.
6. Reassemble once completely dry.

Washable post-motor filter – clean every 6 months

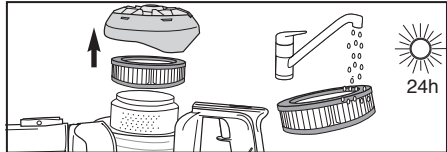

1. Twist filter cover and remove.
2. Lift out post-motor filter.
3. Shake to remove dust.
4. Every 6 months, replace filter or rinse and dry THOROUGHLY.
5. Reposition filter and cover and twist to 'lock'.

Brushroll maintenance - clean frequently or when brushroll indicator light turns red

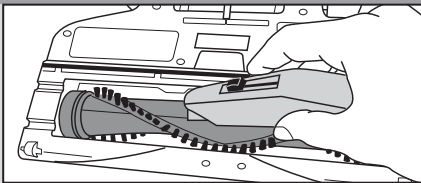

Place motorized floor nozzle upside down. Use scissors or knife to cut strings and threads.

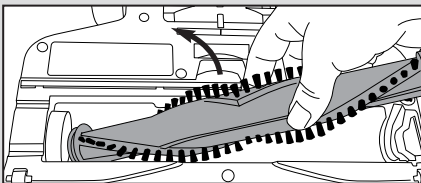

Remove retainer clip and lift out brushroll to clean and remove debris.

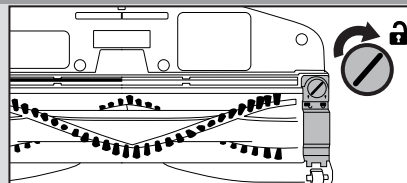

If debris cannot be removed easily, remove retainer clip to access brushroll. Using flathead screwdriver or coin, turn screw to the 'unlock' position.

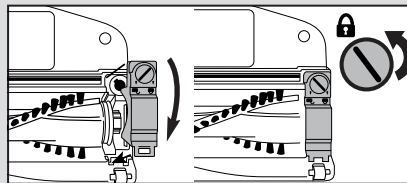

To reassemble:

1. Align one end of brushroll with floor nozzle gear.
2. Press other end into slot.
3. Hook retainer clip under tab and press down.
4. Insert screw and turn to 'lock' position.



**Make sure vacuum cleaner is off, and charging plug is unplugged.**

#### NOTICE : Thermal cut-off

This vacuum cleaner has a special thermostat that protects it in case of motor overheating. **If the vacuum suddenly shuts off**, proceed as follows: 1) Check the vacuum for a possible source of overheating such as a full dust cup, blocked wand or clogged filters. If these conditions are found, fix them and wait at least 30 minutes before attempting to use the vacuum.  
2) After the **30 minute** period, press the power button. If the vacuum still does not work, call the Eureka | Swan Customer Service **HELPLINE** at **0333 220 6050**.

Problem	Solution
<b>Motor will not start</b>	<ul style="list-style-type: none"> <li>• Make sure cleaner is fully powered.</li> <li>• Push charger securely into electrical outlet, try another outlet or check circuit breaker.</li> <li>• See detailed "thermal cut-off" instructions above.</li> </ul>
<b>Charging indicator lights are not lit while charging</b>	<ul style="list-style-type: none"> <li>• Make sure charger is securely inserted into electrical outlet.</li> <li>• Make sure charging plug is securely inserted into handle.</li> <li>• Indicator lights stop blinking when fully charged.</li> </ul>
<b>Not enough suction power</b>	<ul style="list-style-type: none"> <li>• Empty dust cup and clean or change filters. See page 11 for maintenance instructions.</li> <li>• Make sure cleaner is fully powered. Charge battery.</li> <li>• Remove clogs that restrict the airflow.</li> </ul>
<b>Not enough running time</b>	<ul style="list-style-type: none"> <li>• Make sure cleaner is fully powered.</li> <li>• Charge battery for 4 hours before using.</li> </ul>
<b>Hyperhead brush roll will not turn</b>	<ul style="list-style-type: none"> <li>• Check brush roll for debris. See page 11 for maintenance instructions.</li> </ul>



## Discarding the vacuum and battery pack

Before you discard this vacuum, dispose of battery in an environmentally safe manner.  
Do not discard battery with your regular household trash.



Appliances bearing the symbol shown here may not be disposed of in domestic rubbish. You are required to dispose of old electrical and electronic appliances like this separately. Please visit [www.recycle-more.co.uk](http://www.recycle-more.co.uk) or [www.recyclenow.co.uk](http://www.recyclenow.co.uk) for access to information about the recycling of electrical items. Please visit [www.weeireland.ie](http://www.weeireland.ie) for access to information about the recycling of electrical items purchased in Ireland. The WEEE directive, introduced in August 2006, states that all electrical items must be recycled, rather than taken to landfill. Please arrange to take this appliance to your local Civic Amenity site for recycling, once it has reached the end of its life.

## SC15820N

### Performance

- Dust bin capacity: 0.5L
- Battery voltage: 21.6V
- Motor power: 220 Watts
- Sound level: 80dBA
- Charging time: 3.5 Hours
- Running time: up to 30 mins (see note below)

### Accessories

- 1 x 2-in-1 upholstery tool
- 1 x Crevice tool
- 1 x Wall mount charging base
- 1 x Hyper head

### Weight & Dimensions







- Net weight: 2.6kg
- Product size (LxWxH): 25 x 17 x 110cm

**NOTE: Battery usage times can be affected/reduced by the following factors:**

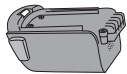
- The type of attachment being used. Eg the crevice tool will drain the power much more slowly than the motorised heads, which have their own motor.
- Carpeted floors offer more resistance than hard floors, so require more power from the battery.
- Clogged filters mean the motor has to work harder and reduces usage time.

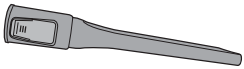
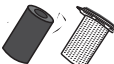

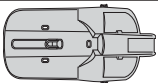
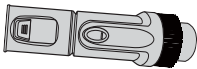
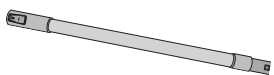
[www.eureka-swan.co.uk](http://www.eureka-swan.co.uk)

	Battery	SC15824N-01
	Charger	SC15824N-02
	Crevice tool	SC15824N-03
	Foam and fiber filters	SC15824N-04
	Post-motor filter	SC15824N-05
	Wall mount	SC15824N-06
	2-in-1 upholstery tool	SC15824N-07
	Wand	SC15824N-08
	Filter screen	SC15824N-09
	Hyper head	SC15820N-01



**eureka | Swan**

## WARRANTY

This product is guaranteed for 2 years from the date of original purchase. If any defect arises due to faulty materials or workmanship the faulty products must be returned to the place of purchase. Refunds or replacement is at the discretion of the store.

**The following conditions apply:**

- The product must be returned to the retailer with proof of purchase.
- The product must be installed and used in accordance with the instructions contained in this instruction guide.
- It must be used only for domestic purposes.
- It does not cover wear and tear, damage, misuse or consumable parts.
- Swan Products Ltd has limited liability for incidental or consequential loss or damage.
- This guarantee is valid in the UK and Eire Only.





[www.eureka-swan.co.uk](http://www.eureka-swan.co.uk)



Scan this QR code  
to hear about  
our story



We love  
what we do



we're proud  
of our quality



Find us on Facebook

\* on selected products

Copyright © Swan Products Ltd.  
PO Box 3117, Stoke-on-Trent ST4 9GD

