



eureka® | Swan

Help line: 0333 220 6050



TMULTIFUNCTION UPRIGHT VACUUM

Model: SC15836N

MULTIFUNCTION PET

Model: SC15838N

v1.0





Follow caution information wherever you see this symbol.

When using an electrical appliance, basic precautions should always be followed, including the following:

READ ALL INSTRUCTIONS BEFORE USING THIS VACUUM CLEANER

Failure to follow the warnings and instructions may result in electric shock, fire and/or serious injury.

WARNING

This vacuum cleaner is intended for household use only and NOT for commercial or industrial use.

- Only use the vacuum cleaner indoors on dry surfaces and keep the area you're cleaning well lit.
- Keep fingers, hair and loose clothing away from moving parts and openings whilst using the vacuum cleaner.
- Use only Eureka | Swan recommended tools and accessories with this vacuum cleaner.
- Don't use the vacuum cleaner if it has been dropped, damaged or left outdoors.
- Don't run over the power cord or use the vacuum cleaner if the power cord or plug is damaged.
- Don't handle the plug or use the vacuum cleaner with wet hands.
- Don't pull or carry the vacuum cleaner by the power cord.
- Don't use the power cord as a handle, pull the power cord around corners, sharp edges or close a door over the power cord.
- Don't unplug vacuum cleaner by pulling on the power cord.
- Turn off all controls on the vacuum cleaner before disconnecting or connecting the power cord.
- Always make sure the filters are in place before use.
- Always switch off the vacuum cleaner before disconnecting or connecting the hose and accessories.
- Keep all openings clear and free from debris as this may affect the air flow/suction.
- Always replace the fuse in the plug with the same type and rating.

- Always protect the power cable from heated surfaces and open flames.
- This appliance can be used by children aged from 8 years and above and persons with reduced physical, sensory or mental capabilities or lack of experience and knowledge if they have been given supervision or instruction concerning use of the vacuum cleaner in a safe way and understand the hazards involved. Children shall not play with the vacuum cleaner. Cleaning and user maintenance shall not be made by children without supervision.
- Don't vacuum up any flammable or combustible materials (lighter fluid, petrol, kerosene etc.) or use the vacuum cleaner in an area with explosive vapours or liquid.
- Don't vacuum up hot coals, cigarette butts, matches or smoking hot, burning items or use in an area where there may be harmful fluids (chlorine, bleach, and ammonia drain cleaner).
- Don't attempt to remove blockages with sharp objects as this may cause damage to the vacuum cleaner.
- Don't vacuum up hard or sharp objects such as glass, nails, screws or coins etc.
- Don't use the vacuum cleaner with incorrect voltage as this may result in damage or injury to the user. The correct voltage is listed on the rating label.
- Take extra care when positioning and using the vacuum cleaner on the stairs.
- Use only CE marked 13 amp extension cords, non-approved extension cords may overheat. Care should be taken to arrange the extension cord as it can be a trip hazard.
- Store the vacuum cleaner in a cool, dry area. If filters have been cleaned as per user guide instructions ensure they are thoroughly dry before storing away.

Please keep instructions for future reference



eureka | Swan

UNPACKING

Carefully unpack and inspect your new Eureka | Swan vacuum cleaner for shipping damage.

Each unit is tested and thoroughly inspected before shipping. For instructions regarding any shipping damage, call the Eureka | Swan Customer Service HELPLINE at 0333 220 6050 immediately.



Make sure your vacuum cleaner is switched off and unplugged when cleaning, removing or refitting parts.



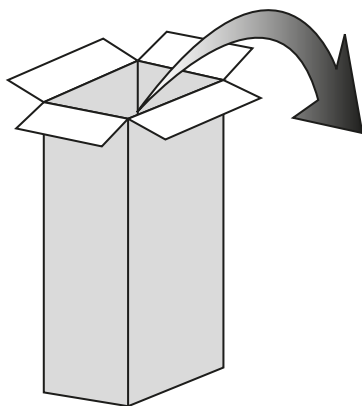

Important safeguards



Upper Cord Hook



Lower Cord Hook



Dusting brush

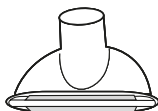

Upholstery tool



Crevice tool

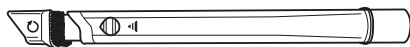

Flexible telescoping crevice tool

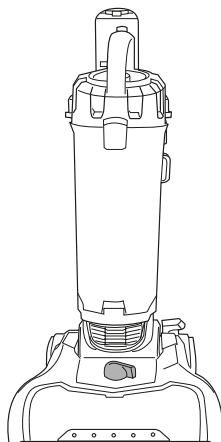

Vacuum cleaner

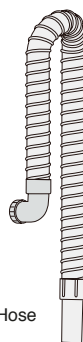

Hose

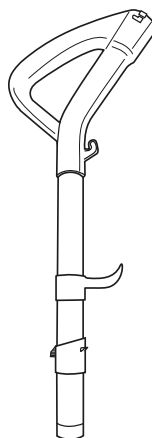

Handle

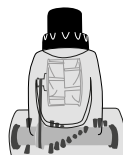

Pet Brush
(SC15838N only)

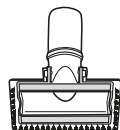

2-in-1 upholstery tool

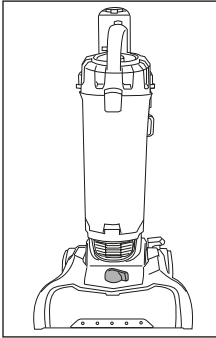

Vacuum cleaner with dust tank.

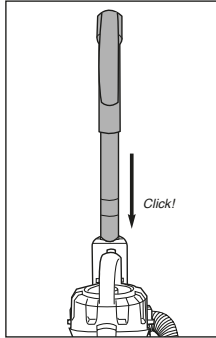

Slide handle into top of vacuum cleaner. Push down until it clicks.

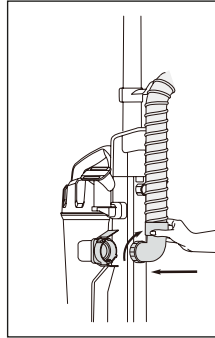

Insert bent end of hose into opening at back of dust tank. Twist hose clockwise to lock.

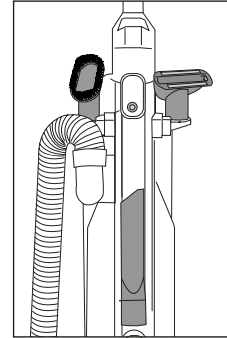

Store accessories on back of vacuum cleaner.

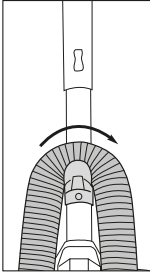

Loop hose over hose retainer.

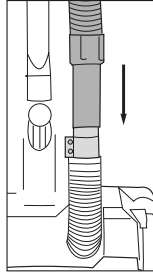

Push loose end of hose securely onto hose inlet.

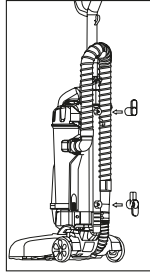

Align upper and lower cord hooks and press to snap in place. Upper cord hook should rotate freely.

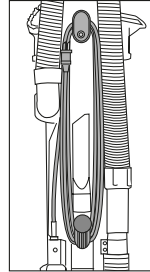

Wrap cord onto upper and lower cord hooks.

Select models only
(NEU182-NEU188
except NEU182A)

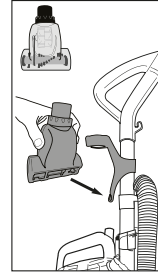

Store turbo brush on front of handle. Align brush opening with slot and push to snap tool into clip.

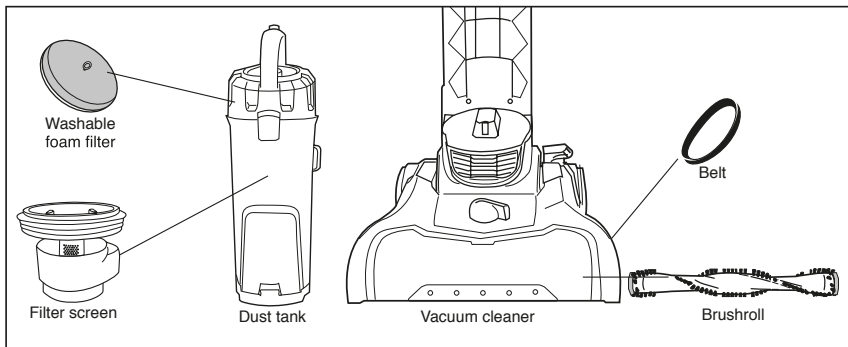
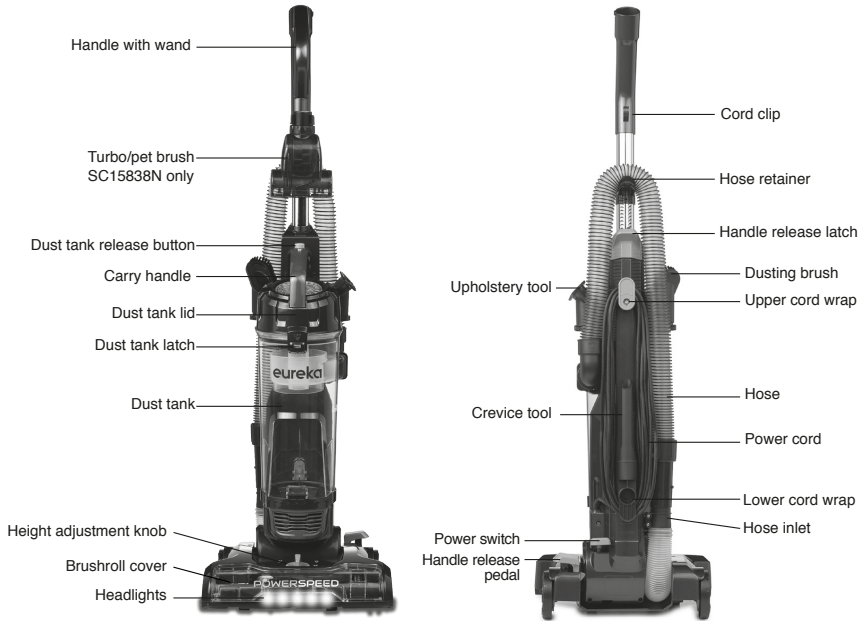



When using on steps:

Position as shown below.

Do not allow the brush roll to come into contact with edge of the stair carpet or damage could occur.

Do not pull on the hose.

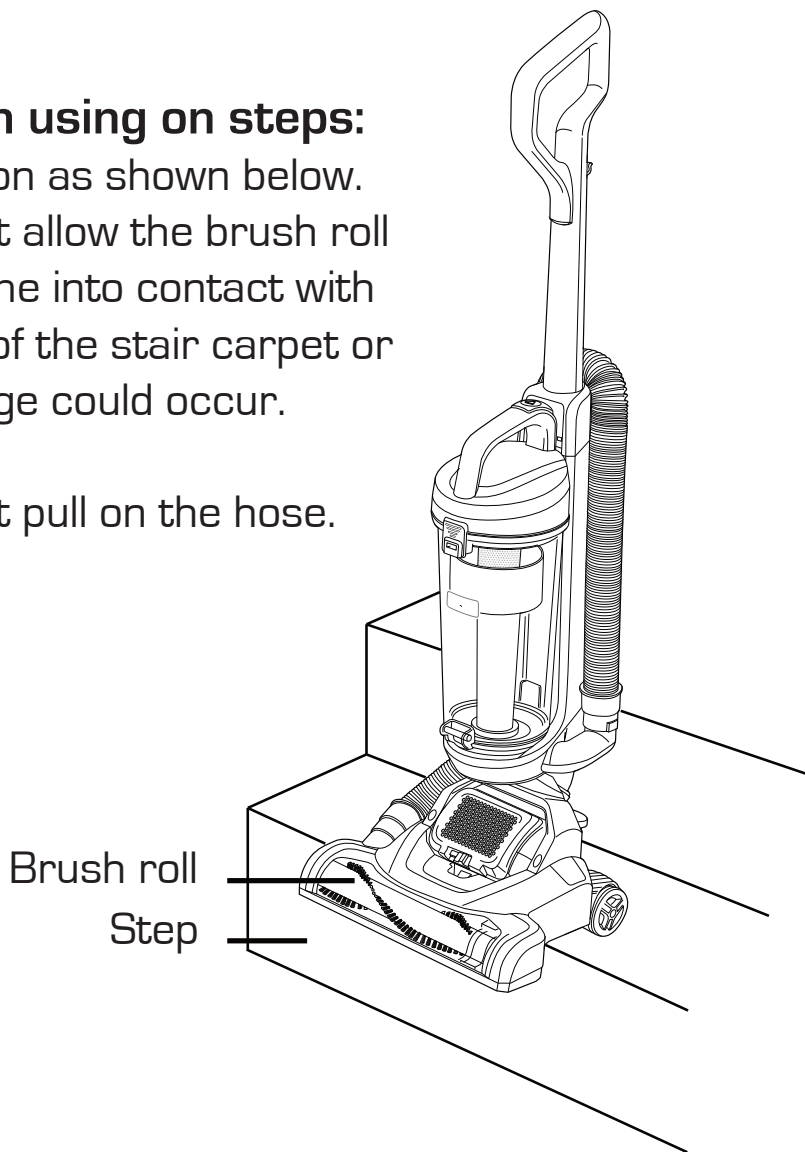

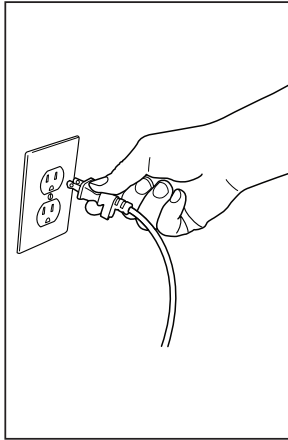

Plug power cord into outlet.

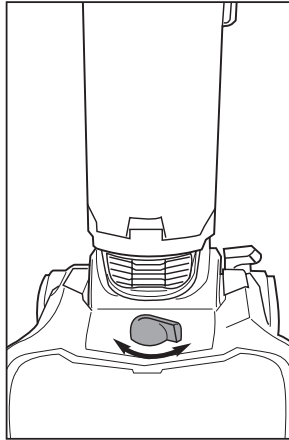

Turn height adjustment knob to adjust from bare floors to high pile carpet.

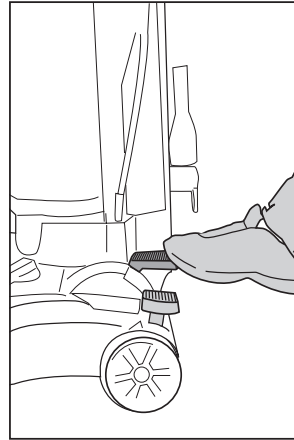

Step on power switch to turn vacuum cleaner on. Step on again to turn off.

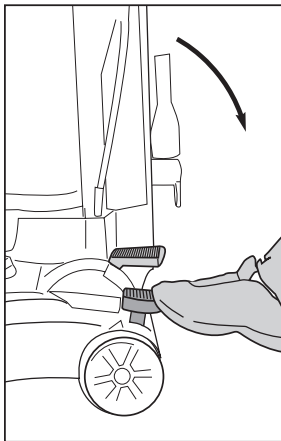

Step on handle release to lower handle into position for vacuuming floors.

Empty dust tank after every use

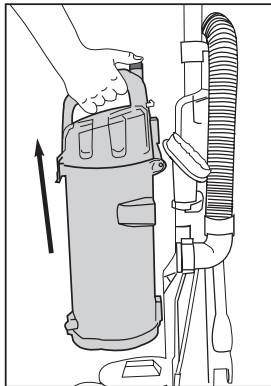

Press release button and lift off dust tank.

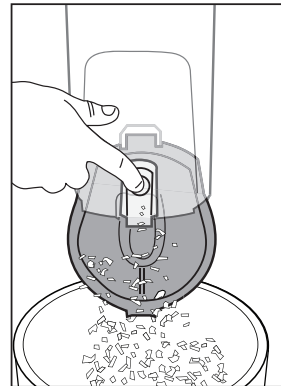

To empty debris, press lever to release bottom lid.

CAUTION

When using tools, always place handle in upright position. Make sure vacuum cleaner is turned off while attaching tools.

- Place vacuum in upright position.
- Turn height adjustment knob to highest position.
- Pull up on hose connection to release hose end from hose inlet (Fig. 1).
- Push end of hose into top of handle and twist clockwise until it clicks (Fig. 2).
- Press handle release latch and pull out handle with wand (Fig. 3).
- To attach accessories, push desired tool onto end of wand (Fig. 4).
- To use accessories without handle and wand, push desired tool directly onto end of hose (Fig. 5).
- When finished using accessories, twist hose counterclockwise and pull off handle. Slide handle into top of vacuum cleaner and push down until it clicks. Push loose end of hose securely onto hose inlet. Store tools on vacuum cleaner back.

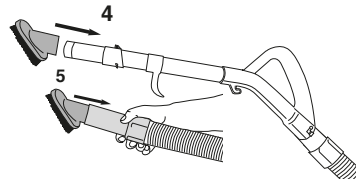
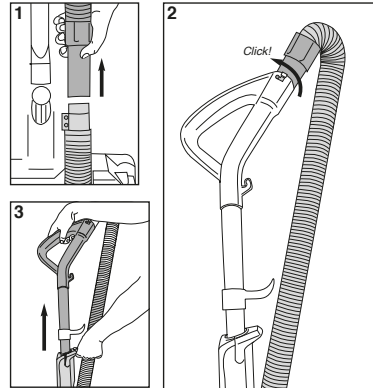

Crevice tool – Use for baseboard edges, corners, detailing chairs, sofas, dryer vents and tight spaces.

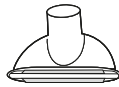

Upholstery tool – Use for furniture, chairs, sofas and mattresses.

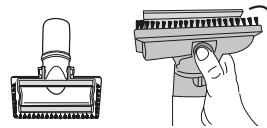

2-in-1 upholstery tool – Use brush to vacuum upholstered surfaces or pick up debris. Use felt portion to clean delicate surfaces. Press thumb release and lift brush up and out of the way.

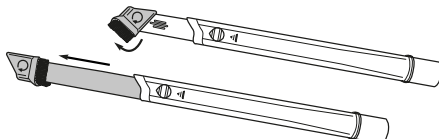

Flexible telescoping crevice tool (– Press button and pull to extend tool to desired length. To use brush, pull to swivel into position. Use for baseboards, crevices and tight spaces.



Dusting brush – Use for furniture, drapes, blinds, drawers and vents.



Turbo/pet brush (SC15838N) – Use to remove pet hair from stairs, carpet and upholstery.

Dust Tank – Empty after each use

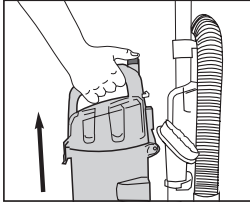

Press release button and lift off dust tank.

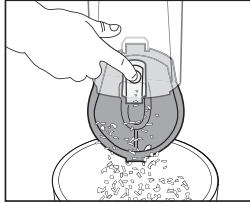

Hold dust tank over wastebasket and press lever to release bottom lid. Debris will empty.

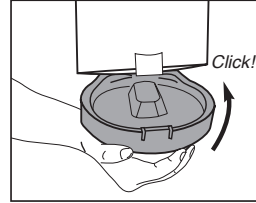

Close bottom lid until it clicks.

Washable dust cup filters – Clean monthly

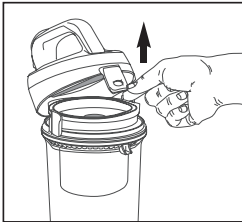

Pull dust tank latch to lift up dust tank lid.

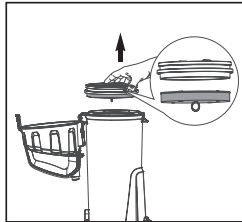

Lift out foam filter and shake off dust. Rinse foam filter and dry THOROUGHLY.

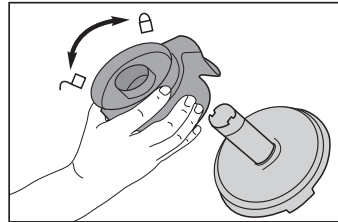

Grip tabs and lift out filter screen. Twist bottom of filter screen counterclockwise to unlock and pull apart. Shake off dust. Rinse screen and dust tank. Dry all THOROUGHLY. Reassemble screen; twist clockwise to lock.

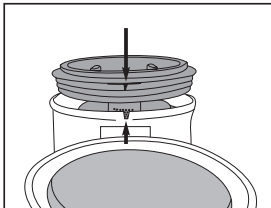

Align tab on filter screen with slot on back of dust tank and drop into position.

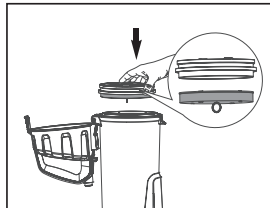

Reinstall foam filter.



Close cover until it clicks.



Warning: Never operate vacuum cleaner without foam filter, filter screen and dust tank in proper position.

How to clear a blockage

⚠ CAUTION

Make sure vacuum is turned off and power cord is unplugged.

If vacuum is not cleaning floors, or if no suction at end of hose, check to be sure air path is not blocked.

- Press release button and lift off dust tank (Fig. 1).
- Empty debris. Hold over wastebasket and press lever to release bottom lid (Fig. 2).
- Check filter and filter screen. Remove any debris and shake off dust. (See maintenance instructions on page 9.)
- Loosen end of hose.
- Use a rod or similar blunt implement to clear a blockage in wand or hose. Flex hose to loosen debris (Fig. 3). Use caution if there is any risk that glass or nails could have become imbedded in hose.
- Use finger to check for debris in air path (Fig. 4).
- Reinstall filter and filter screen inside dust tank and position dust tank onto vacuum cleaner.

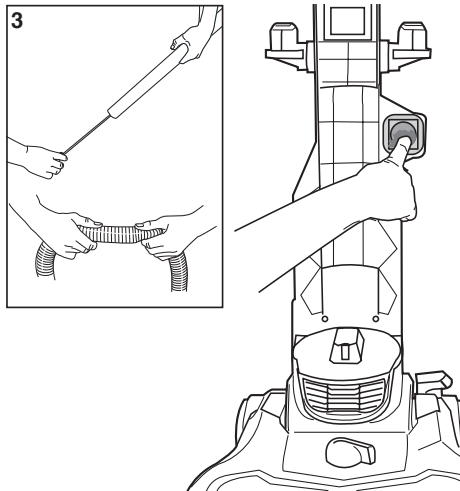
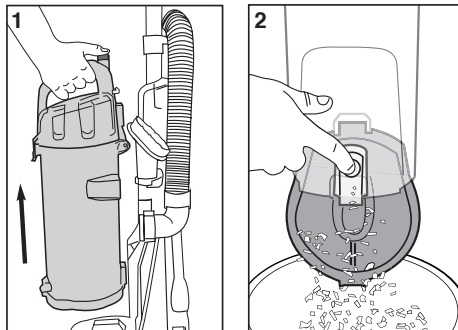

⚠ Warning: Never operate vacuum cleaner without foam filter, filter screen and dust tank in proper position.

How to maintain brushroll

⚠ CAUTION

Make sure vacuum is turned off and power cord is unplugged.

- Step on handle release to lower handle.
- Turn vacuum face down on floor.
- To avoid unnecessary service calls, check brushroll for debris.
- Use scissors to clip heavy threads or strings.

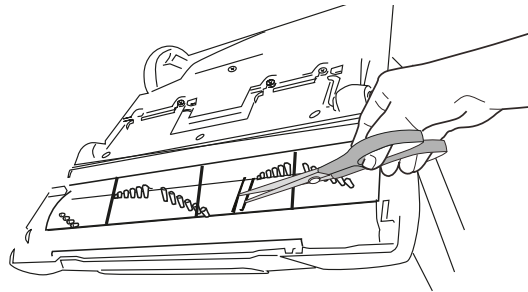
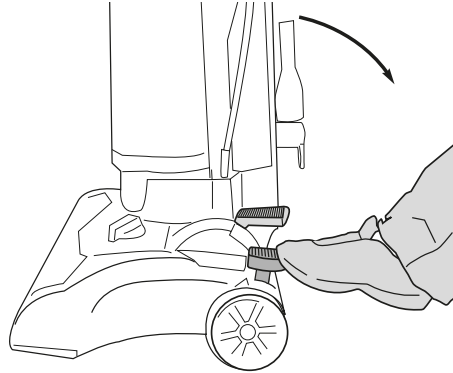

How to maintain turbo brush

Select models only (NEU182-NEU188 except NEU182A)

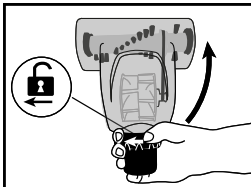

Grasp collar and twist to unlock cover. Lift cover up.

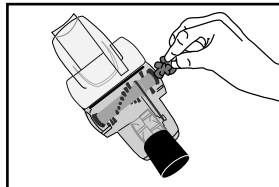

With cover open, use fingers or small brush to clear accumulated pet hair from bristles.

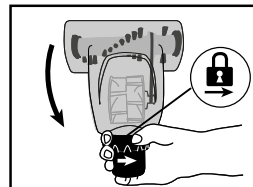

Close cover and twist collar to lock.

How to replace brushroll or belt

CAUTION

Make sure vacuum is turned off and power cord is unplugged.

- Step on handle release and lay vacuum cleaner face down.
- Use Phillips screwdriver to remove 6 screws from brushroll cover (Fig. 1). Lift off cover. Refer to Fig. 7 for location of screws.
- Rotate right end of brushroll and lift out (Fig. 2).
- Lift out left end of brushroll.
- To replace belt, position new belt around motor shaft (Fig. 3).
- Loop new belt around brushroll shaft at left end of brushroll (Fig. 4).
- To reposition brushroll into base, pull belt down and insert left end of brushroll first. Align brushroll end cap with slot so it fits into position (Fig. 5). Press right end of brushroll into position.
- To replace brushroll cover, align slot on cover with tab (Fig. 6) and snap cover into place. Replace 6 screws (Fig. 7).

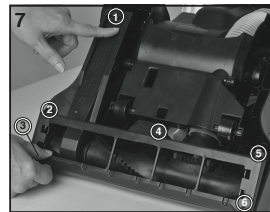
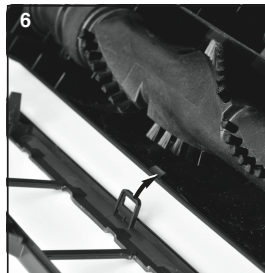
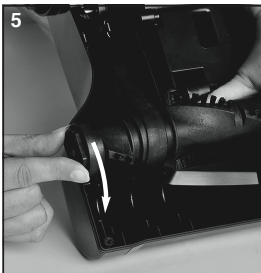
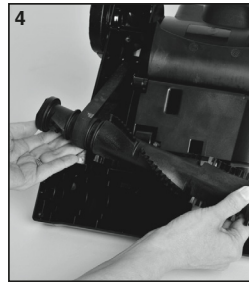
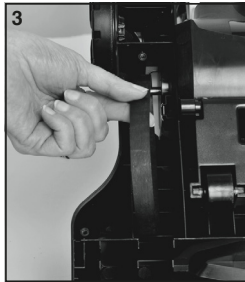
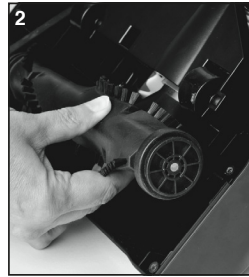
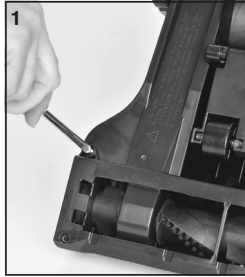



Make sure vacuum is turned off and power cord is unplugged.

NOTICE : Thermal cut-off

This vacuum cleaner has a special thermostat that protects the vacuum in case of motor overheating.

If the vacuum suddenly shuts off, proceed as follows: 1) Push the power switch to off and unplug the vacuum. 2) Check the vacuum for a possible source of overheating such as a full dust cup, blocked hose or clogged filter. If these conditions are found, fix them and wait at least 30 minutes before attempting to use the vacuum. 3) After the 30 minute period, plug the vacuum back in and turn on the switch. If the vacuum still does not work, call the Swan Customer Service **HELPLINE** at **0333 220 6050** .

Problem	Solution
Motor will not start.	<ul style="list-style-type: none"> • Push plug securely into outlet, try another outlet or check circuit breaker. • Step on power switch to turn vacuum on. • See detailed "thermal cut-off" instructions above.
Vacuum cleaner does not clean floors.	<ul style="list-style-type: none"> • Empty dust tank, clean and/or change filter. • Clean or replace filter regularly to maintain suction. • Check vacuum height adjustment knob position. • Clean brushroll if needed.
No suction at the end of hose or wand.	<ul style="list-style-type: none"> • See other solutions above. • Remove clogs from the hose or wand that restrict the airflow.
Burning smell; brushroll will not turn.	<ul style="list-style-type: none"> • Check brushroll for debris. • Replace broken or out of shape belt.
Vacuum is hard to push.	<ul style="list-style-type: none"> • Adjust vacuum height knob to a higher position. • Check brushroll for debris and clean if needed.
Turbo brush will not turn SC15838N	<ul style="list-style-type: none"> • Check turbo brush for debris.



Appliances bearing the symbol shown here may not be disposed of in domestic rubbish. You are required to dispose of old electrical and electronic appliances like this separately. Please visit www.recycle-more.co.uk or www.recyclenow.co.uk for access to information about the recycling of electrical items. Please visit www.weeeireland.ie for access to information about the recycling of electrical items purchased in Ireland. The WEEE directive, introduced in August 2006, states that all electrical items must be recycled, rather than taken to landfill.

Please arrange to take this appliance to your local Civic Amenity site for recycling, once it has reached the end of its life.











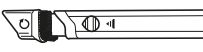

This product is guaranteed for 2 years from the date of original purchase. If any defect arises due to faulty materials of workmanship the faulty products must be returned to the place of purchase. Refunds or replacement is at the discretion of the store.

The following conditions apply:

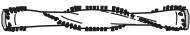
- The product must be returned to the retailer with proof of purchase.
- The product must be installed and used in accordance with the instructions contained in this instruction guide.
- It must be used only for domestic purposes.
- It does not cover wear and tear, damage, misuse or consumable parts.
- Swan Products Ltd has limited liability for incidental or consequential loss or damage.
- This guarantee is valid in the UK and Eire Only.



Visit www.swan-brand.co.uk or call 0333 220 6050

Image	Part name	Part number
	Dusting brush tool	SC15836N-01
	Crevice tool	SC15836N-02
	Upholstery tool	SC15836N-03
	Flexible telescoping crevice tool	SC15836N-04
	2-in-1 upholstery tool	SC15836N-05
	Turbo brush	SC15836N-06
	Washable foam filter	SC15836N-07
	Brushroll	SC15836N-08
	Hose	SC15836N-09
	Belt	SC15836N-10
	Detachable handle	SC15836N-11
	Dust tank	SC15836N-12
	Upper and lower hooks	SC15836N-13







www.eureka-swan.co.uk

Follow us online



www.swan-brand.co.uk

Copyright © Swan Products Ltd.
PO Box 3117, Stoke-on-Trent ST4 9GD

