

Swan

designed for life

X

Lynsey



v1.0
09/21



Also includes:
**PowerPlush
motorised head**



Lightweight Cordless Vacuum

with Lithium-Ion Battery



We love
what we do



We're proud
of our quality

www.swan-brand.co.uk/support

Model: SC15820QOCN

A Word from Lynsey Queen of Clean

Thank you so much for purchasing from my range!

Over my 18 year career in home care I have always dreamed of creating ingenious cleaning tools that make housework a pleasure, not a chore.

Swan Brand and I have combined our expertise to turn my day-dreams into a gleaming reality, with fabulous products that'll transform your busy household into a sparkling, pristine palace.

Let's get cleaning!





Important Safety Information

Please read this instruction manual carefully and keep in a safe place for future reference.

- Avoid unintentional starting. Ensure the switch is in the off-position before connecting to battery pack, picking up or carrying the appliance. Carrying the appliance with your finger on the switch is dangerous.
- **DANGER!** Do not touch nozzle when the vacuum cleaner is on.
- Do not put any object into openings. Do not use with any openings blocked; keep free of dust, lint, hair and anything that may reduce air flow.
- Do not use outdoors or on wet surfaces.
- Do not operate the vacuum cleaner or charger if it has been damaged in any way. If the vacuum cleaner is not working as it should, has been dropped, damaged, left outdoors, or dropped into water, please visit the Swan website at www.swan-brand.co.uk/support for advice.
- To avoid excessive heat and damage to the unit or battery, the vacuum cleaner will not operate while charging.
- Do not allow to be used as a toy. Close attention is necessary when used by or near children.
- Use only as described in this manual. Use only manufacturer's recommended attachments.
- Recharge only with the charger specified by the manufacturer. A charger that is suitable for one type of battery pack may create a risk of fire when used with another battery pack.

Important Safety Information

- Do not pull or carry the charger by cord, use cord as a handle, close a door on cord, or pull cord around sharp edges or corners. Do not run appliance over cord. Keep cord away from heated surfaces.
- This charger is not intended for travelling purposes, motor homes or caravans.
- Do not use extension cords or outlets with inadequate current carrying capacity for the charger.
- Do not unplug by pulling on cord. To unplug, grasp the plug, not the cord.
- Do not handle charger or vacuum cleaner with wet hands.
- Use appliances only with specifically designated battery packs. Use of any other battery packs may create a risk of injury and fire.
- **Do not modify, manipulate or incinerate batteries. Batteries become dangerous at high temperatures.**
- Liquid ejected from the battery may cause irritation or burns. If the liquid gets on the skin, (1) seek medical attention, (2) wash quickly with soap and water, and (3) neutralize with a mild acid such as lemon juice or vinegar. If the liquid gets into the eyes, flush them immediately with clean water for a minimum of 10 minutes.
- When battery pack is not in use, keep it away from other metal objects, like paper clips, coins, keys, nails, screws or other small metal objects, that can make a connection from one terminal to another. Shorting the battery terminals together may cause burns or a fire.
- This product has a functioning temperature range within 5°C-40°C.

Important Safety Information

- Do not use a battery pack or appliance that is damaged or modified. Damaged or modified batteries may exhibit unpredictable behaviour resulting in fire, explosion or risk of injury.
- Do not expose a battery pack or appliance to fire or excessive temperature. Exposure to fire or temperature above 130°C may cause explosion.
- Follow all charging instructions and do not charge the battery pack or appliance outside of the temperature range specified in the instructions. Charging improperly or at temperatures outside of the specified range may damage the battery and increase the risk of fire.
- Have servicing performed by a qualified repair person using only identical replacement parts. This will ensure that the safety of the product is maintained.
- Do not modify or attempt to repair the appliance or the battery pack except as indicated in the instructions for use and care.
- The terminals on both the vacuum cleaner and battery should be kept free and clean of objects. Do not insert metal objects inside the terminals.
- This vacuum cleaner creates suction. Keep hair, loose clothing, fingers, and all parts of body away from openings and moving parts.
- Do not pick up anything that is burning or smoking, such as cigarettes, matches, or hot ashes.
- Do not use without filters in place.
- Take extra care when cleaning stairs.
- Do not use to pick up flammable or combustible liquids, such as gasoline/petrol, or use in areas where they may be present.

Important Safety Information

- Store vacuum cleaner and charger indoors in a cool, dry area. To avoid electric shock and/or cleaner damage, do not expose to weather elements.
- Keep your work area well lit. Unplug electrical appliances before vacuuming them.
- Overcharging, short circuiting, reverse charging, mutilating or incinerating the cells and the batteries must be avoided.
- If a cell or a battery has leaked or vented, it should be replaced immediately using protective gloves.
- If and when necessary, these cells or batteries must be replaced with identical new ones from the same manufacturer. If a cell or a battery to be replaced is connected with other cells or batteries in series, it is recommended that the other cells or batteries be replaced with new ones at the same time.
- Reverse polarity installation of the cell or the battery in the end product must be avoided.
- Do not incinerate this appliance even if it is severely damaged. Contact your local waste facility before discarding in trash.
- This appliance can be used by children aged from 8 years and above if they have been given supervision or instruction concerning use of the appliance in a safe way and if they understand the hazards involved. Cleaning and user maintenance shall not be made by children unless they are older than 8 and supervised. Keep the appliance and its cord out of reach of children aged less than 8 years.

CAUTION: Never operate vacuum cleaner without all filters, filter screen and dust cup in proper position.

Technical Specifications

Description:	Lightweight Cordless Vacuum
Model:	SC15820QOCN
Dust bin capacity:	500ml
Battery voltage:	21.6V
Motor power:	220 Watts
Sound level:	80dBA
Charging time:	3.5 Hours
Running time:	up to 30 mins (see note below)
Net weight:	2.6kg
Product size:	250mm (L) x 170mm (W) x 110mm (H)
Accessories:	2-in-1 Upholstery Tool, Crevice Tool, Wall Mount Charging Base, HyperBrush Head, PowerPlush Head

NOTE: Battery usage times can be affected/reduced by the following factors:

- The type of attachment being used (e.g. the crevice tool will drain the power much more slowly than the motorised heads, which have their own motor).
- Carpeted floors offer more resistance than hard floors, so require more power from the battery.
- Clogged filters mean the motor has to work harder and reduces usage time.



CAUTION!

Do not immerse
in water

What's in the box

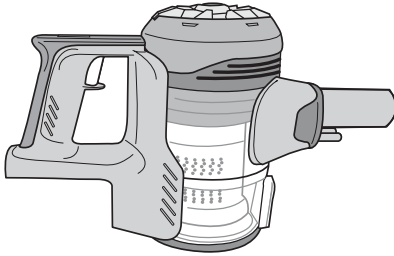

Hand vacuum

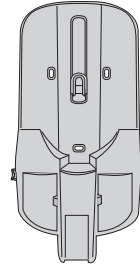

Wall mounted charging base

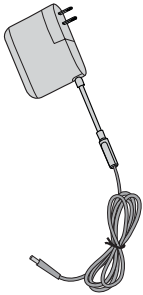

Charger



Wand

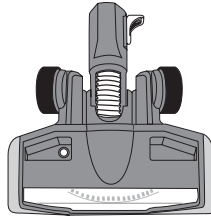

HyperBrush Head

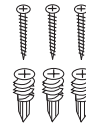

3 screws
& wall plugs

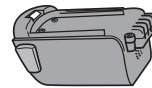

Battery

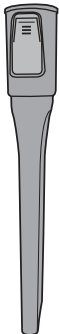

Crevice tool

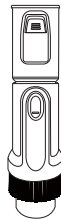

2-in-1 upholstery tool

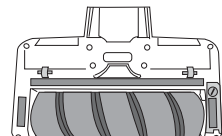
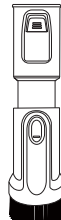

PowerPlush Head

Get to know your vacuum

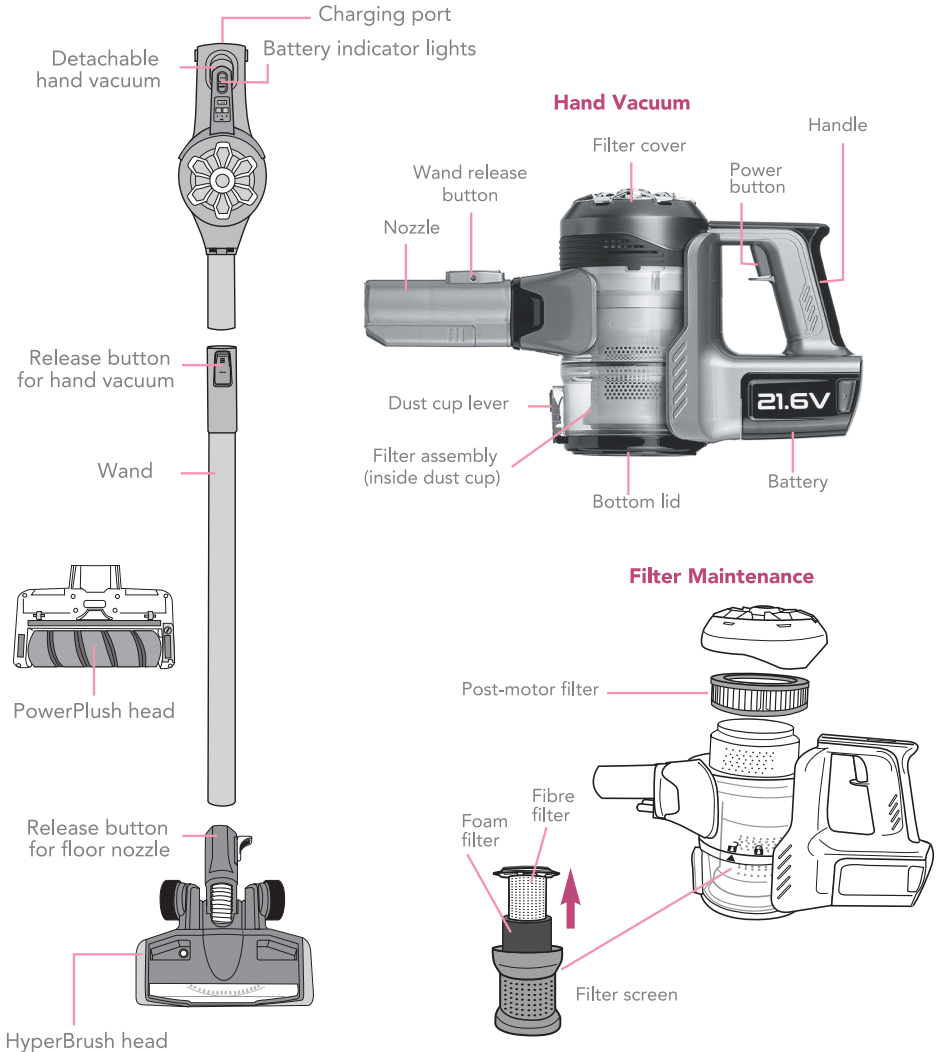

Product Assembly

Product Assembly

1. Slide battery onto hand vacuum until firmly attached (**Fig. 1**).
2. Slide wand onto hand vacuum until it clicks (**Fig. 2**).
3. Push wand into motorized floor nozzle until it clicks (**Fig. 3**).

How to install wall mount

- Choose location near power outlet. Locate point high enough on wall to allow wand and motorized floor nozzle to hang freely.
- Place mount against wall and use pencil to mark drill holes.
- Drill holes with 6mm bit and insert all plugs. Insert screws through holes on mount and tighten until firmly attached (**Fig. 4**).

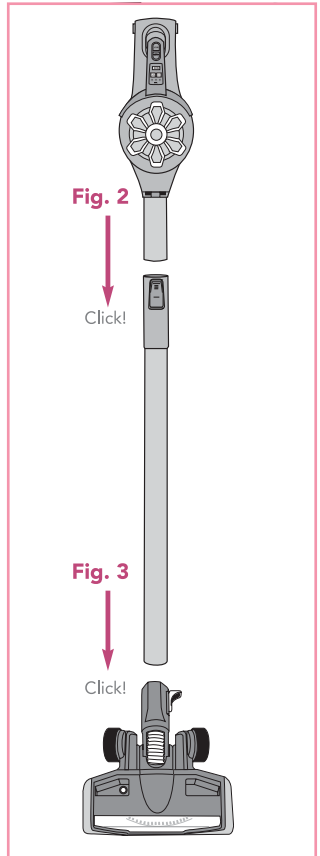
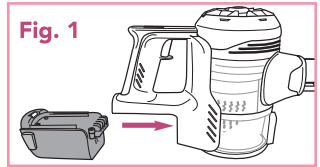

Battery Charging

How to charge the battery and store accessories

- Place assembled vacuum cleaner on wall mount.
- Plug charger into power outlet and then into charger port on handle (**Fig. 5**).
- Loop charger cord into clips on sides of wall mount.
- Snap tool(s) into tool storage areas (**Fig. 5**).

Battery indicator lights show level of charge (**Fig. 5**)

- A** – Fully charged
- B** – Half charged
- C** – Low power

- Indicator lights stop blinking when fully charged.
- Charge battery fully before using for the first time. This may take up to four hours.

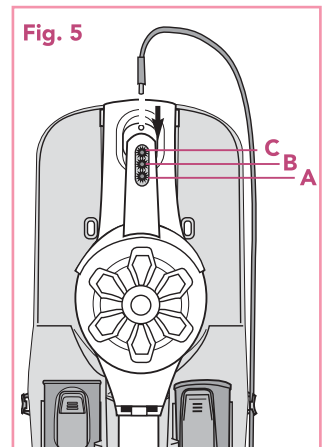
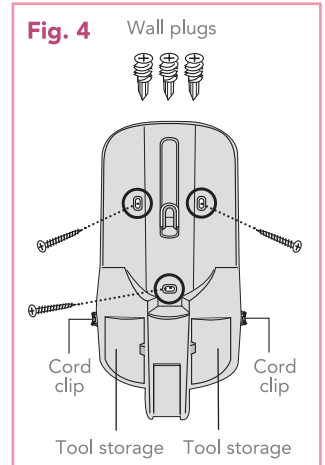

How to use cleaner for cleaning floors

1. Click power button once to start **(Fig. 1)**.
2. Using motorized floor head or plush brush roll, glide back and forth on area to be cleaned. Avoid oversized or sharp items (such as screws) with cleaner.
3. Twist wrist to engage swivel function.
4. When done, click power button once to stop motor.

Fig. 1

Power button

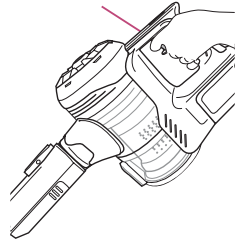
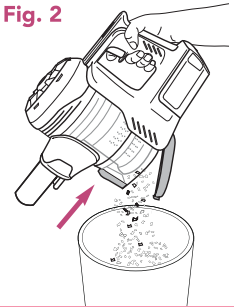



Fig. 2



Empty dust cup after every use

There are two ways to empty the dust cup:

1. Hold cleaner over waste basket. Press lever to release bottom lid of dust cup to empty debris **(Fig. 2)**.
2. Or, remove dust cup from hand vacuum by twisting to 'unlock'  position **(Fig. 3)**.

Once emptied, reattach dust cup by lining up arrow  and 'unlock'  position.

Twist dust cup until arrow  lines up with 'locked'  position.

Fig. 3



How to use hand vacuum and accessories

CAUTION: Moving parts. Always turn off hand vacuum before attaching accessories

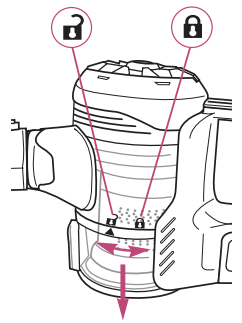
The hand vacuum can be used with or without tools.

- To use without tools, press release button and remove wand. Collect debris directly with hand vacuum nozzle (**Fig. 4**).
- To use tools with wand, press release button to remove motorized floor nozzle. Slide tool onto end of wand until it clicks (**Fig. 5**).
- To use tools with hand vacuum only, press release button to remove wand. Slide tool onto hand vacuum until it clicks (**Fig. 3**).

Fig. 4

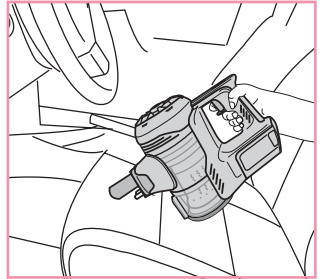
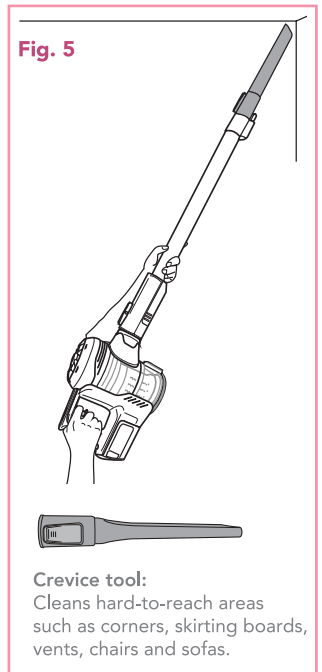

Fig. 5



HyperBrush Motorised Head

Ideal for cleaning stairs

- Press release button to remove wand from hand vacuum.
- Attach HyperBrush head directly to hand vacuum until it clicks.
- Click power button once to start.



2-in-1 Upholstery Tool

Use with or without wand

- Use brush to vacuum blinds, vents or upholstered surfaces.
- Use felt portion to clean delicate surfaces.
- To switch between felt and brush portions, press thumb release and slide brush up or down.

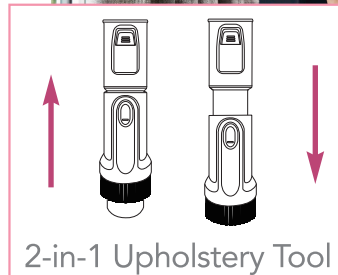

Maintenance

Washable Dust Cup Filter Clean monthly

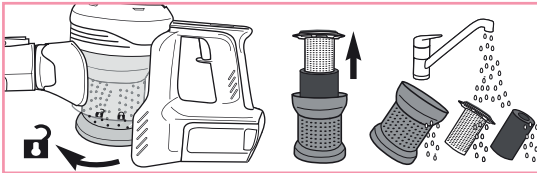

Dry for 48 hours in
a warm dry location

WARNING! If not fully dried the filters will partially or fully clog very rapidly and this will expose the motor to the risk of burning out and also reducing the battery run time.

1. Twist dust cup and remove.
2. Twist filter screen and remove.
3. Lift out foam filter and holder.
4. Separate foam filter from fibre filter by pulling them apart.
5. Rinse and dry **THOROUGHLY**.
6. Reassemble once completely dry.

Maintenance

Washable Post-motor Filter Clean every 6 months

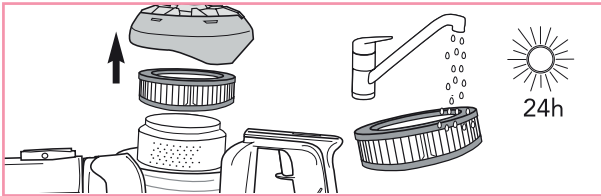

1. Twist filter cover and remove.
2. Lift out post-motor filter.
3. Shake to remove dust.
4. Every 6 months, replace filter or rinse and dry **THOROUGHLY**.
5. Reposition filter and cover and twist to 'lock.'

Maintenance

Brush Roll Maintenance

Clean frequently or when brush roll indicator light turns red

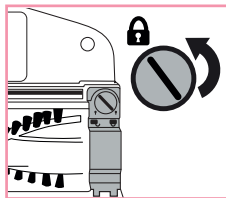
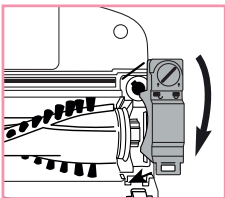
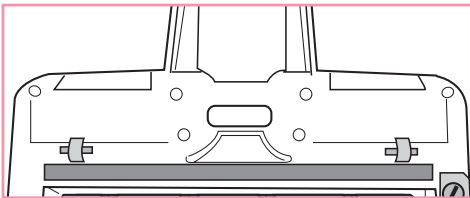
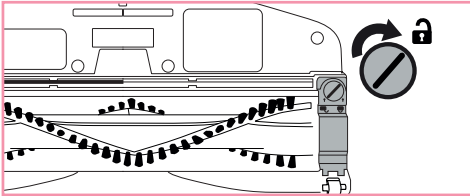
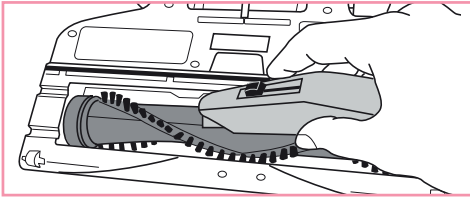

1. Place motorized floor nozzle upside down. Use scissors or knife to cut strings and threads.
2. If debris cannot be removed easily, remove retainer clip to access brush roll. Using flathead screwdriver or coin, turn screw to the 'unlock' position.
3. Remove retainer clip and lift out brush roll to clean and remove debris.
4. To reassemble:
 - a. Align one end of brush roll with floor nozzle gear.
 - b. Press other end into slot.
 - c. Hook retainer clip under tab and press down.
 - d. Insert screw and turn to 'lock' position.

Before First Use

1. Carefully remove your appliance from the packaging and remove all packing materials.
2. To avoid danger, always keep packaging materials (plastic bags, polystyrene, etc.) away from children. Dispose of the packaging in a responsible manner.
3. Check that the main product, the accessories, the power cord and the plug are in good condition and show no signs of damage.

Troubleshooting

WARNING: Make sure vacuum cleaner is off, and charging plug is unplugged.

NOTICE: Thermal cut-off

This vacuum cleaner has a special thermostat that protects it in case of motor overheating.

If the vacuum suddenly shuts off, proceed as follows:

1. Check the vacuum for a possible source of overheating such as a full dust cup, blocked wand or clogged filters. If these conditions are found, fix them and wait at least 30 minutes before attempting to use the vacuum.
2. After the 30 minute period, press the power button. If the vacuum still does not work, please visit the Swan website at www.swan-brand.co.uk/support for advice.

Troubleshooting

Problem	Solution
Motor will not start	<ul style="list-style-type: none"> • Make sure cleaner is fully powered. • Push charger securely into electrical outlet, try another outlet or check circuit breaker. • See detailed “thermal cut-off” instructions above.
Charging indicator lights are not lit while charging	<ul style="list-style-type: none"> • Make sure charger is securely inserted into electrical outlet. • Make sure charging plug is securely inserted into handle. • Indicator lights stop blinking when fully charged.
Not enough suction power	<ul style="list-style-type: none"> • Empty dust cup and clean or change filters. See page 15 for maintenance instructions. • Make sure cleaner is fully powered. Charge battery. • Remove clogs that restrict the airflow.
Not enough running time	<ul style="list-style-type: none"> • Make sure cleaner is fully powered. • Charge battery for 4 hours before using.
HyperBrush head roll will not turn	<ul style="list-style-type: none"> • Check brush roll for debris. See page 17 for maintenance instructions.

Spares

To order spare parts please visit our website:

www.swan-brand.co.uk

Replacement Part	Part Number
HyperBrush Head	SC15820PIN01
PowerPlush Floor Head	SC15820PIN07
Wand	SC15820PIN08
Handheld Dust Container	SC15820PIN014
Battery	SC15824N-01
Charger	SC15824N-02
Crevice Tool	SC15824N-03
Foam and Fibre Filters	SC15824N-04
Post-motor Filter	SC15824N-05
Wall Mount	SC15824N-06
2-in-1 Upholstery Tool	SC15824N-07
Filter Screen	SC15824N-09

Plug Wiring

These safety instructions should be read carefully and kept in a safe place for future reference.

This appliance is fitted with a plug that complies with BS 1363. Only high quality 13A (square pin) plugs that comply with this standard should be fitted.

Wires are coloured as follows:

BROWN	LIVE
BLUE	NEUTRAL
YELLOW & GREEN	EARTH

If the appliance is fitted with a 2-core cable it is double insulated and will not have the yellow and green earth wire.

IT IS ESSENTIAL THAT WIRES ARE ATTACHED ONLY TO THEIR DESIGNATED POSITIONS IN THE PLUG.

Fuses must be replaced with the same rating as the original; please refer to the fuse rating stated on the plug for this information. Only genuine fuses compliant with BS 1362 should be used.

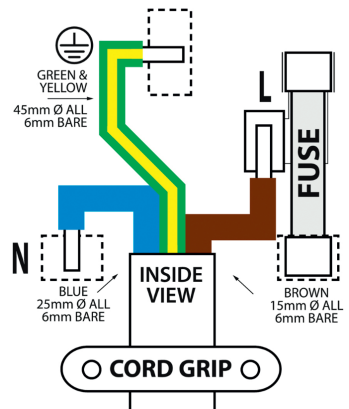



Warranty

This product is guaranteed for 2 years from the date of original purchase. If any defect arises due to faulty materials or workmanship the faulty products must be returned to the place of purchase. Refunds or replacement is at the discretion of the store.

The following conditions apply:

- The product must be returned to the retailer with proof of purchase.
- The product must be installed and used in accordance with the instructions contained in this instruction guide.
- It must be used only for domestic purposes.
- It does not cover wear and tear, damage, misuse or consumable parts.
- Swan Products Ltd has limited liability for incidental or consequential loss or damage.
- This guarantee is valid in the UK and Eire Only.

Helpline: **0333 220 6050**

Find advice online: **www.swan-brand.co.uk/support**

Disposal of Unit



Appliances bearing the symbol shown here may not be disposed of in domestic rubbish. You are required to dispose of old electrical and electronic appliances like this separately.

Please visit www.recycle-more.co.uk or www.recyclenow.co.uk for access to information about the recycling of electrical items. Please visit www.weeeireland.ie for access to information about the recycling of electrical items purchased in Ireland. The WEEE directive, introduced in August 2006, states that all electrical items must be recycled, rather than taken to landfill. Please arrange to take this appliance to your local Civic Amenity site for recycling, once it has reached the end of its life.

Swan

designed for life

X



We love
what we do



We're proud
of our quality

Follow us Online



www.swan-brand.co.uk

Copyright © 2021
Swan Products Ltd. PO Box 3117, Stoke-on-Trent ST4 9GD