



1. This photo shows the intended orientation of the rods in relation to the fretboard/neck interface. For maximum efficiency, the tension/compression rod should be positioned such that the heel end or body end of the rod be placed as far down from the fretboard/neck interface as the intended neck carve will safely allow, perhaps 1/16"-1/8" from the backside of the neck nearest to the heel transition. The nut end of the rod is placed flush with the fretboard/neck interface, as shown (similar to PRS and also my preferred method). An alternative is to position the nut end of the rod deeper toward the backside of the neck and slid more toward the peghead (similar to Gibson), so that overall, the rod runs much closer to parallel to the fretboard (this positioning of the rod will not be demonstrated here in this pictorial, but may be covered sometime in the future, if need be). Either method is much more preferable to installing the rod directly under the fretboard like you would a conventional modern "two-rod" trussrod, which operates in a different, more "self contained" way. A quick rule-of-thumb would be that the farther the rod is from the fretboard, the more leverage the rod has to do its job. Take care to position rod such that the end of the adjustment nut stays inside of the mark of where the peghead will be cut.

The mahogany blank is for a classical guitar build in which the adjustment nut will be accessible through the sound hole. I chose this method mainly to conceal any visual traces of the rod's existence once the guitar is completed. Also, it will be more readily accessible to make adjustments, if need be. Looking closely at the rod, you can see that it has something of an extended-reach adjustment rod (available as a stock item). Also seen on this rod is a wooden sheath (optional upgrade). Otherwise, this rod coincides with our 13" Flexstrong trussrod (or as we call it, our "white rod"). This rod configuration may look somewhat confusing at the moment, but should become clearer to you in later photos. The maple billet will be two 24³/₄" scale electric guitar blanks, bolt-on style on which I will show to you two different slot routing methods. The

rods for these necks are identical, standard length, baseline rods with polyolefin sheaths (stock item), which coincide with our 17" Flexstrong trussrod ("purple rod").



2. Here, we see two pieces of $\frac{1}{2}$ " thick MDF board which will serve as the heart of the routing jig required for cutting the slot that the rod resides in. The required size of the boards varies depending on neck dimensions and rod length (the requirements will become apparent as we go). At least one long edge of each board must be worked to a straight and square surface. These edges will be our "router bit rub bearing guides". However, I will not be employing bearings on my bits; I prefer using the bare shaft of the bit as my rub guide (with lubrication). You are welcome to adapt my instructions to using pattern bearing bits or guide bushings, but extra care must be taken to ensure that the corners where the endblock notches intersect with the main slot stay sharp and do not get too rounded over, so that the endblocks have enough wood to buttress against. I jointed both sides of both boards, as I will use them for routing all three neck samples.



3. I have temporarily joined the MDF boards together with double-sided tape so the straight edges are flush and will mark the placement of the endblocks of the rod (in my case, rods), leaving a few inches of length on either side of the rod(s).



4. I have marked the endblock locations and have placed an allen wrench in front of (but not inside of) the adjustment nut to mark the outside edge of the wrench. This is necessary to insure that we provide ample access to the nut with the wrench upon installation of the rod (this

procedure is not necessary for my classical neck sample). This mark is where the slot will terminate at the peghead end of the neck.

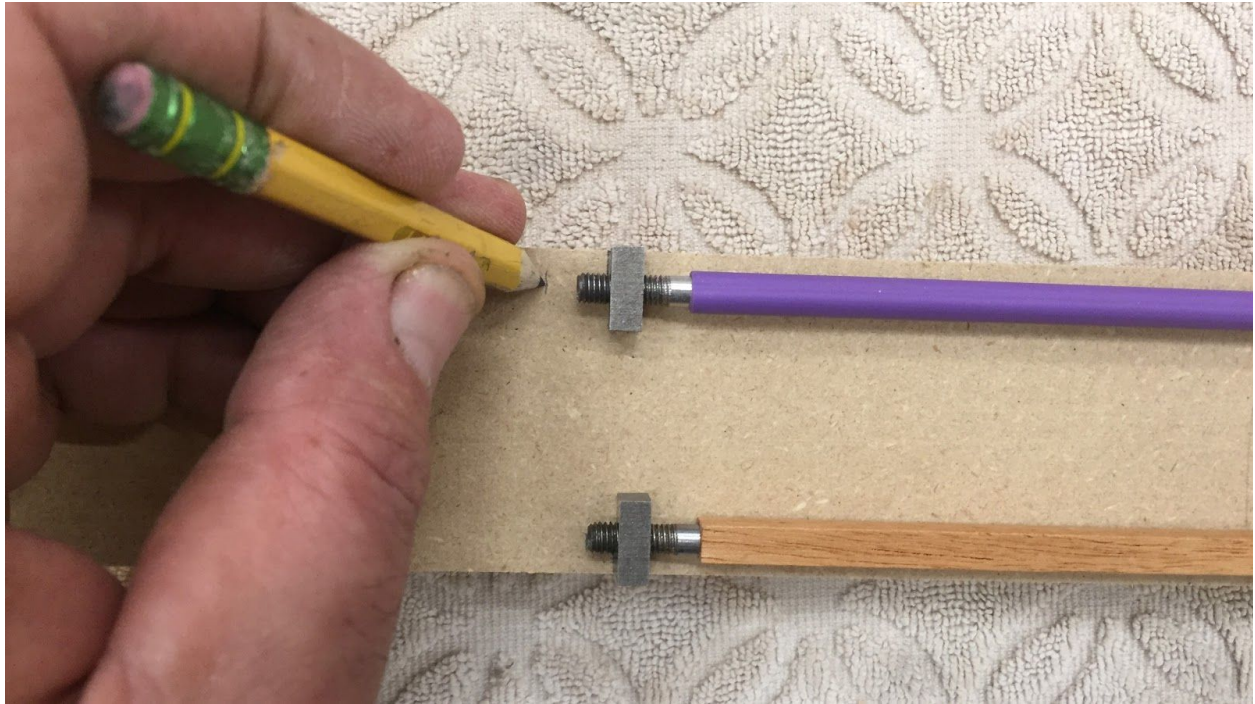

5. Here, I'm marking the threaded end of the rod, plus 1/8" or so, extra to provide ample space for the rod when/if it is "tightened", or compressed (in reality, the rod will likely only be required to turn less than one revolution in either direction if installed properly in a typical guitar under typical conditions).

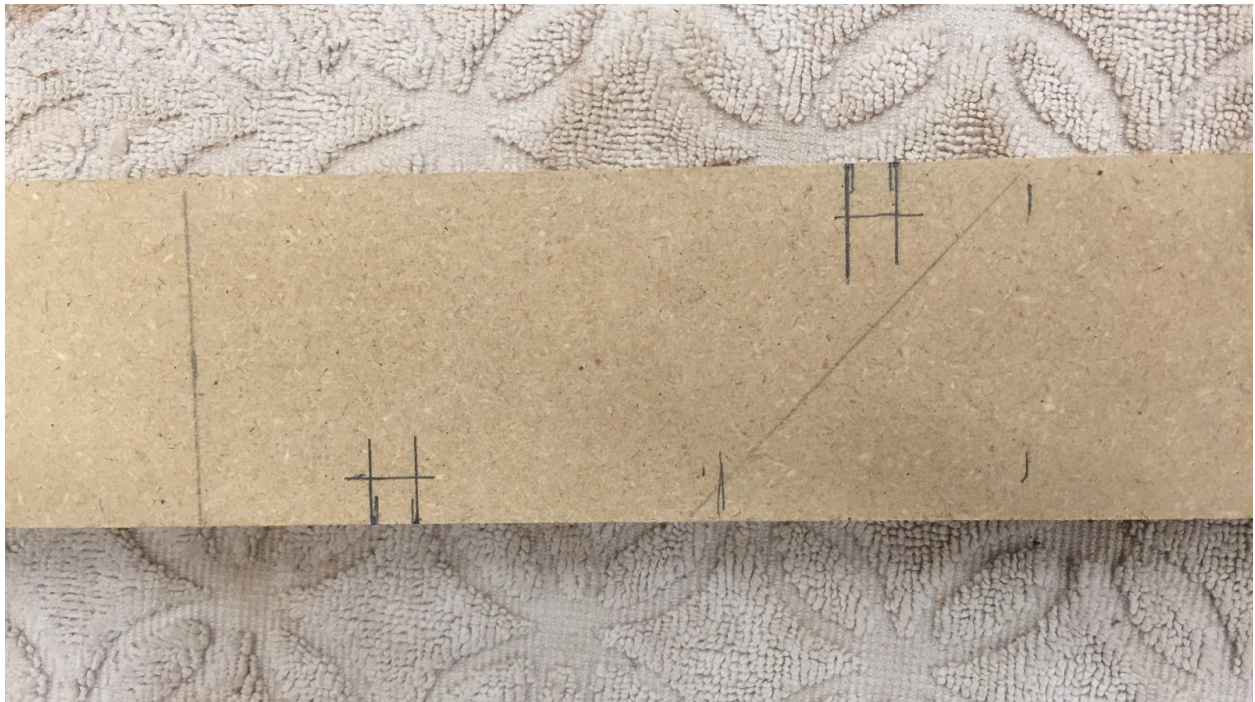

6. The endblocks are $\frac{3}{16}$ " wide. However, the router bit, having a $\frac{1}{4}$ " shank, will require that we widen these markings to $\frac{1}{4}$ ". The lines added that run parallel to the edges of the board measure slightly more than $\frac{1}{4}$ " from the edge. These lines are where we will notch the boards to enable routing for the endblocks.



7. I cut the notches on a tablesaw so the shank of a $\frac{1}{4}$ " router bit fits perfectly with almost no extra gap.



8. I stuck a razorblade between the boards to separate them slightly, so I could apply some thin cyano-glue to the corners. This keeps the corners nice and crisp for clean routing. If I was making this jig for long-term use, I would likely “case-harden” the entire edges of the boards with glue. Incidentally, that’s how I make almost all of my routing jigs.

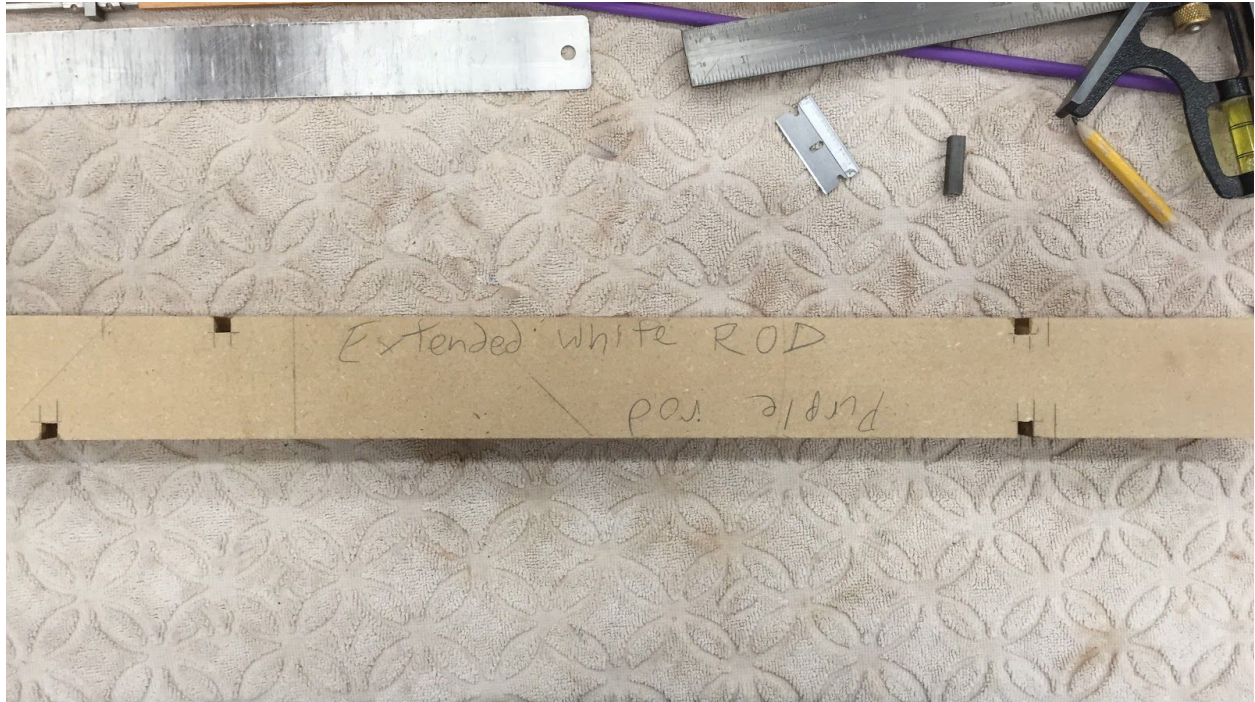

9. Notching and gluing completed.

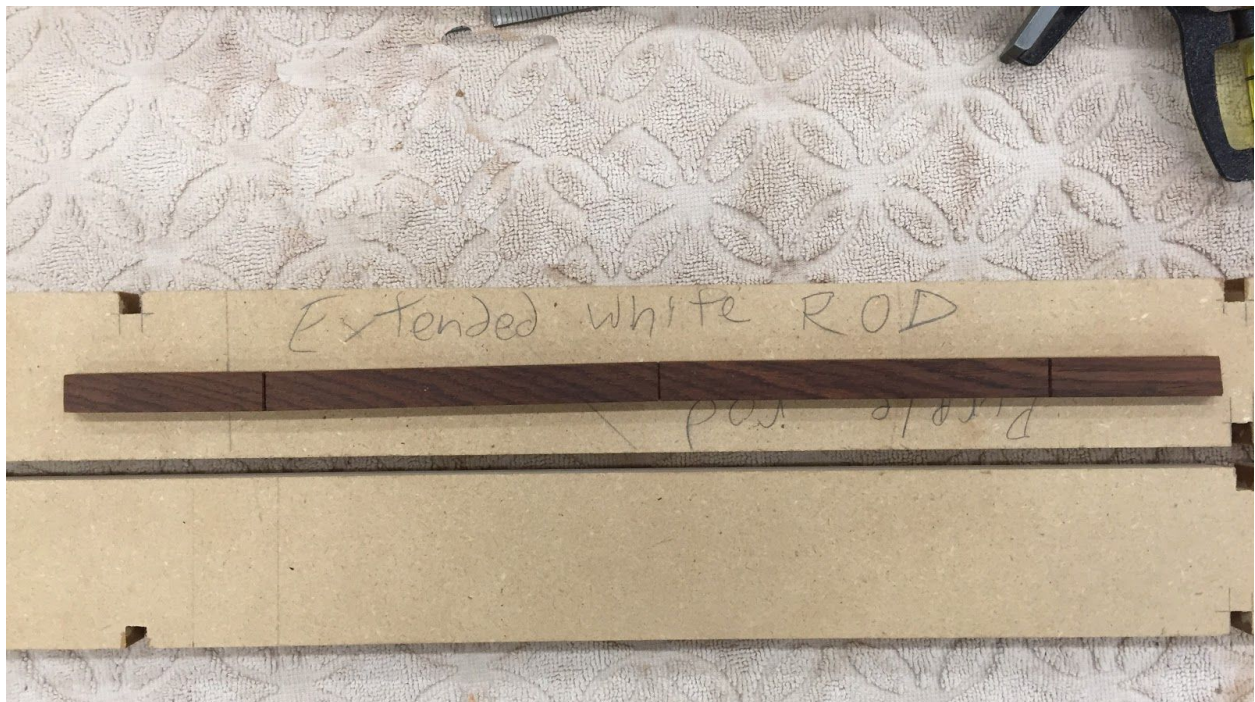

10. I milled a $\frac{1}{4}$ " x $\frac{1}{2}$ " x whatever length blank from a hardwood scrap (Amazon rosewood in this case) and cut it into random lengths a few inches long. It only matters that the cross-cuts are

square, the thickness is the same as your router bit shaft (or perhaps a tiny bit wider) and the width no wider than the thickness of the MDF. These will be spacers placed between the two boards that create a channel that the router bit will ride between.

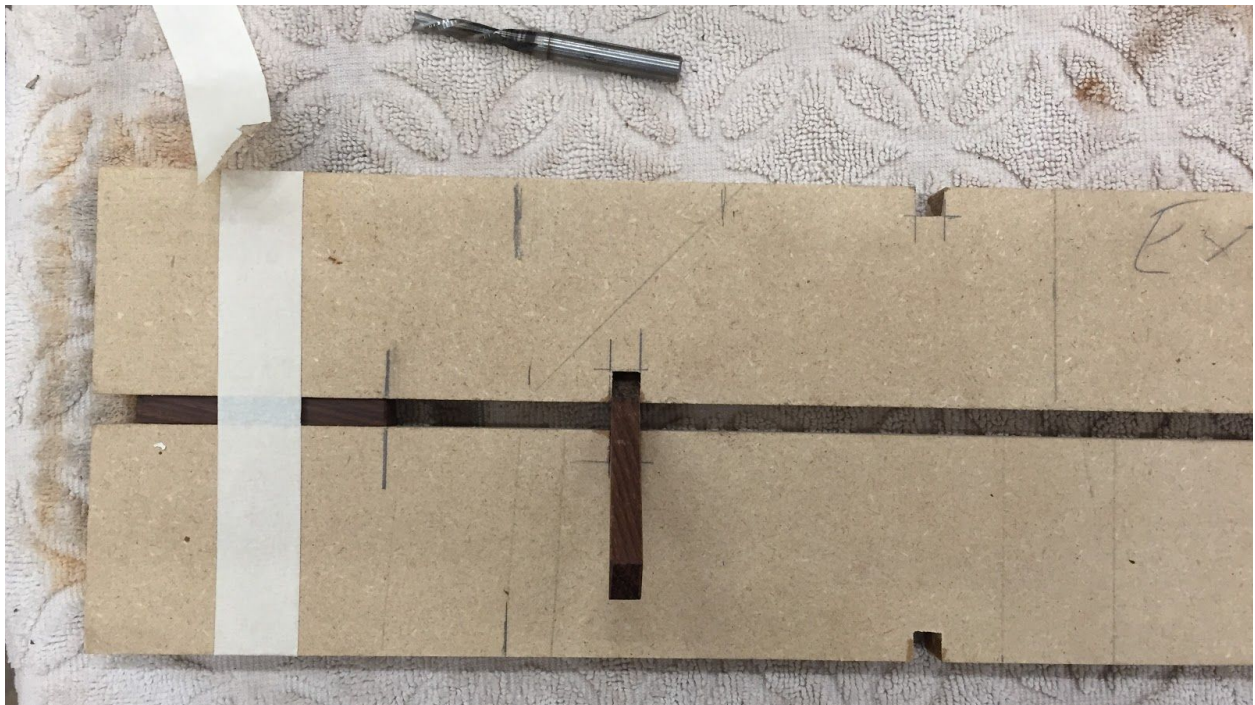

11. I positioned the MDF boards side-to-side with the endblock notches opposing each other (I'm building the jig up for the "purple rod" first) and stuck a spacer temporarily in the notches to perfectly align them. I then placed a spacer at each end of the jig-to-be to create both the length and width of the routing slot and taped it all together (I taped it together so I could easily disassemble it after routing the maple necks and reassemble it for the classical guitar neck). You of course can make your jig or jigs in a more permanent fashion. I slid the shank of a 1/4" bit along the channel to make sure that the bits will ride comfortably along without being too snug or too sloppy. This photo, by the way, is showing the adjustment end of the jig.



12. The entire length of the jig once joined together.



13. With the rod laid in place on the neck blank along its intended line of depth, I measured the space between the top of the endblock at the heel end of the neck and the top of the neck blank, or neck/fretboard interface. This is the exact thickness of the spacers we are going to add to the underside of the jig where the endblock notches are on the peghead end (in most cases the adjustment end) of the jig.



14. Here are the spacers attached to the bottom of the jig at the peghead end with double-sided tape. These spacers were milled to a thickness of .482" minus the thickness of the double-sided tape.



15. Once the spacers are in place, MDF must be removed from the bottom of the jig at the opposing end such that the far edges of the endblock notches meet the top surface of the neck blank. An easy way to do this is to pass the heel end of the jig repeatedly over a jointer blade until the proper amount of material is removed, as shown in the next photo.



16. I went a tiny bit past the mark so it would be perfect after reapplying the masking tape. The tape and spacer behind it that you see here was temporarily placed during jointing just to help hold the jig together.



17. The next step is to attach two rails along the length of the jig to the underside. These rails will serve three functions: to add stiffness to the jig, to position the jig perfectly centered over the neck blank and for use in clamping the jig to the neck blank. First, lay the jig upside down and position the neck blank onto the jig so that they are perfectly centered to each other, width-wise.

Then, place a length of ½" MDF (or any wood that has been surface-milled straight and square and is thick enough to take a screw) next to each side of the neck blank and tack them in place at each end with instant glue. Pull the neck blank out from between the rails and turn the jig over. Drill and countersink pilot holes over and near each end of each rail; four in total, then drive in wood screws. The rails will be securely fastened to the jig, yet still be somewhat flexible near their centers. This is good for clamping the jig to the neck blank.



18. This photo shows the jig placed over the neck blank so the endblock notches line up with the endblock markings on the neck blank. I taped the bottom of the rails to the sides of the neck blank to help keep the jig in place while I clamp it to the neck blank.

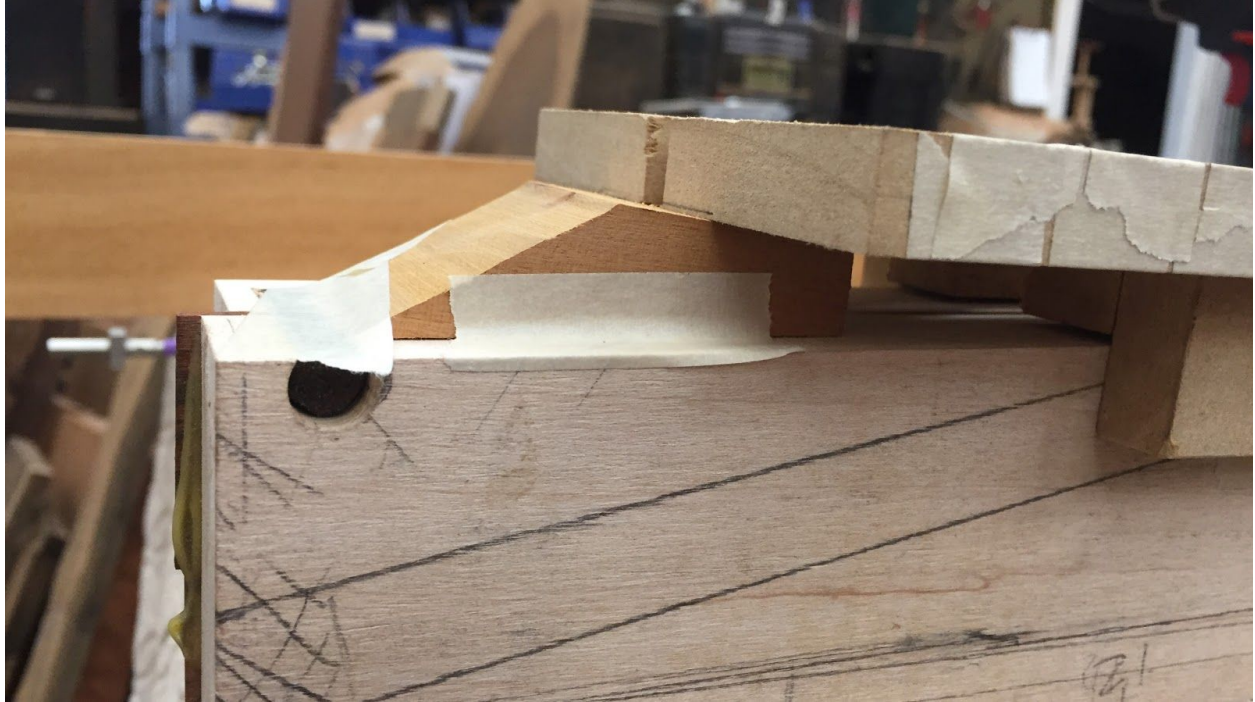

19. This photo shows a tapered chunk of wood slid under the jig until the tapered surface meets the underside of the jig and then taped down to the neck blank. Then (not shown in this photo), a small piece of wood is glued in place to the top of the wedge block while butted up to the end of the jig. This wedge block serves two functions: to support the end of the jig while the router passes over the area and to act as an indexing apparatus in case you want or need to remove the jig prior to completion of the trussrod cavity.



20. The jig is shown here clamped to the neck blank. The clamp furthest to the left is there only to support the assembly while the router passes over that end of the jig. The assembly is now ready for routing; but first, the final depth of cut, or rather, the final distance from the tip of the bit to the surface of the router base should be established. Adding the thickness of the spacers (mine are .482") to the thickness of the jig (.5") and the height of the endblocks (.325") will give you the answer (mine =1.307"). It's helpful to thickness a scrap of wood to the exact measurement to use as a depth gauge.

The first neck will be cut so the main slot and notches are all 1/4" wide, with flat bottoms. Then, we'll cut the next neck with a round-bottom slot with 3/16" wide, flat-bottom notches (although both ways work well, I prefer the latter method). The classical neck blank will be cut with a flat-bottom slot (as required by the wood sheath) and 3/16" wide notches.

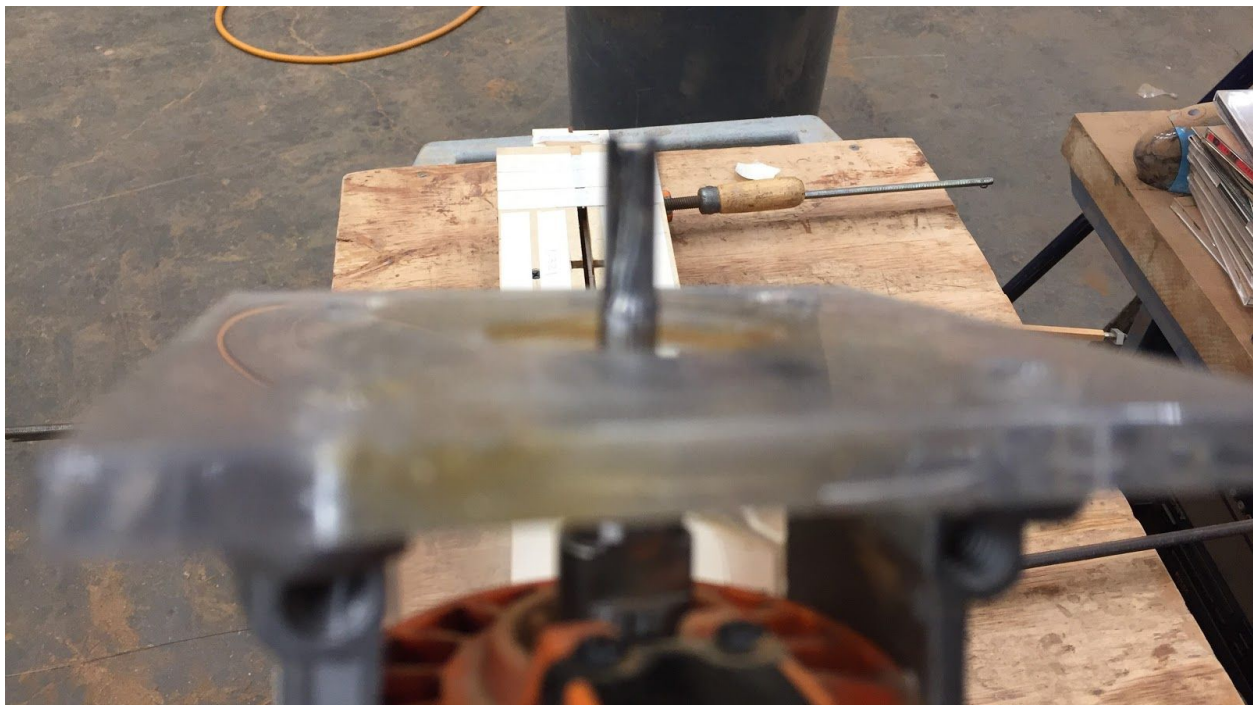

21. My preferred router for this job is a laminate trimmer, or trim router. They are light and compact with enough power to do the work. I will be using only one router and making adjustments/swapping bits as I go. If you are in a production situation, you can use multiple routers with different bits/settings (perhaps even one router per step) and much time will be saved.

On the first neck blank, routing will start with two or three passes with a 1/4" x 1/2" dado bit and then two or three more passes with a 1/4" x 1" dado bit. Throughout this pictorial, am using mostly straight-flute bits. However, spiral flute bits (both up-shear and down-shear) also work well; as long as you are familiar with the pros and cons of their usage. No matter what style(s) you use, make sure that the shanks are at least 1" long. Set them in the collet so that half of the shank (1/2") is exposed.

Before the first pass is commenced, the channel and notches of the jig need to be lubricated with palm oil (or any fat in a semi-solid form, such as lard, butter, petroleum jelly, etc.) on a cotton swab. If it's too cold/solid, warm it up a bit. Don't use so much that it can get onto the

surface of the neck blank, but be thorough. Coat the shank lightly, as well. For the first cut, adjust the router base so that about 1/8" or so, of the shank is exposed (as seen in the photo). This will make the first pass about 3/16" to 1/4" deep at the heel end of the neck blank (the bit will not engage with the neck surface until about half way down the slot). Make two or three more passes at 1/8" to 1/4" increments until you are forced to change to the 1" cutter. You should re-lube every other pass, or so.



22. This photo shows that I have chucked up the 1" bit and set the base for the next pass. I then set the depth of cut for the final pass and completed the routing phase of the installation.



23. I placed the rod into the new cavity to make sure that the depth was right (if the endblock nearest the peghead is flush with the surface of the neck [or below], it's good). Next, I made and installed a thin filler-strip (shown here) to compensate for the differences in height between the rod and endblocks.



24. The rod placed into the neck blank. Lubricate the rod at the endblocks before setting it in place for the last time.



25. Another view.



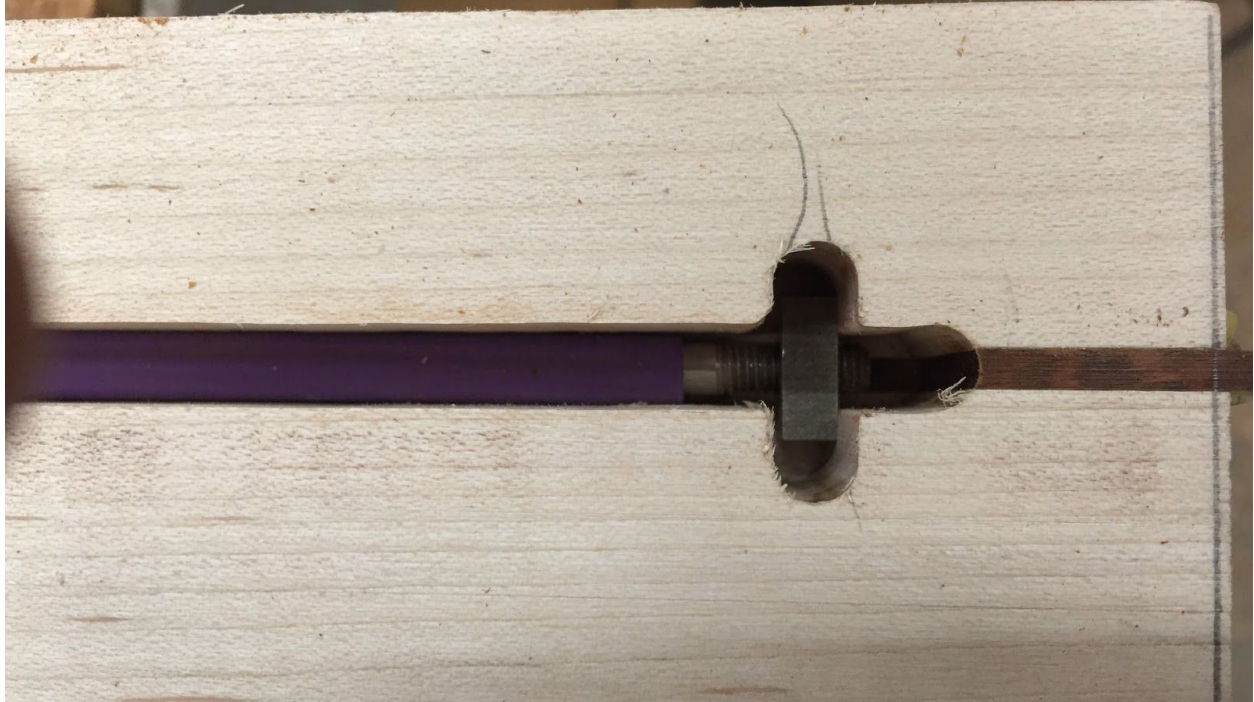

26 a, b. Once the rod is in place, turn the adjustment nut counter-clockwise until the outsides of the endblocks are firmly buttressed against the walls of the notches, as shown.





27 a, b. Next, mill a strip of hardwood approximately 1/16" x 3/16" and round over one edge so it will fit in the gaps between the endblocks and the inside walls of the notches, as shown. Make sure the strip fits quite snugly. Push or tap it all the way down one of the four gaps, then clip off the extra length. Proceed with the remaining three gaps.



28. Shape strips of wood to conform to the remaining voids at the endblocks and for the main channel. Softer/lighter woods are fine for these areas. Put them in place for marking the cutoff

lines (as shown), trim and replace. You may glue them in, or proceed to leveling the filler wood flush (I glued them with cyno.).



29. The installation is complete.



30. The steps for the second version of routing the cavity are much the same as the first, but with a few different steps. Here, you can see the cutter that will be used for the main channel,

ready for the first pass (although the cutting length on this bit isn't very deep, the shank is quite long; it is still capable of cutting the required depth). This time, however, I will cut only along the main channel, bypassing the notches, until the final depth is achieved. Also, I will compensate for the difference in height between the endblocks and the rod in the final depth of the channel (about .035").



31. For the endblock notches this time, I am using a 3/16" x 1" (which happens to be a down-shear spiral) with a 1/4" shank. Because of the cutting length of this bit, I will need to compensate for this on the first few cuts of the heel end notches by building up a riser with another layer of MDF to elevate the cutter 1/2". This will insure that the cuts are not deeper than the bit can handle. Also, it will insure that the cutter doesn't wander into the main channel.



32. First, as you can see here, I milled a scrap of wood to fit snugly into the opposing notches and across the channel. I then placed a chunk of MDF against each face of the filler wood and taped them down. Then, I fit two more pieces of wood between the MDF pieces, pushed them up to the filler wood and tack-glued them to one of the MDF chunks.

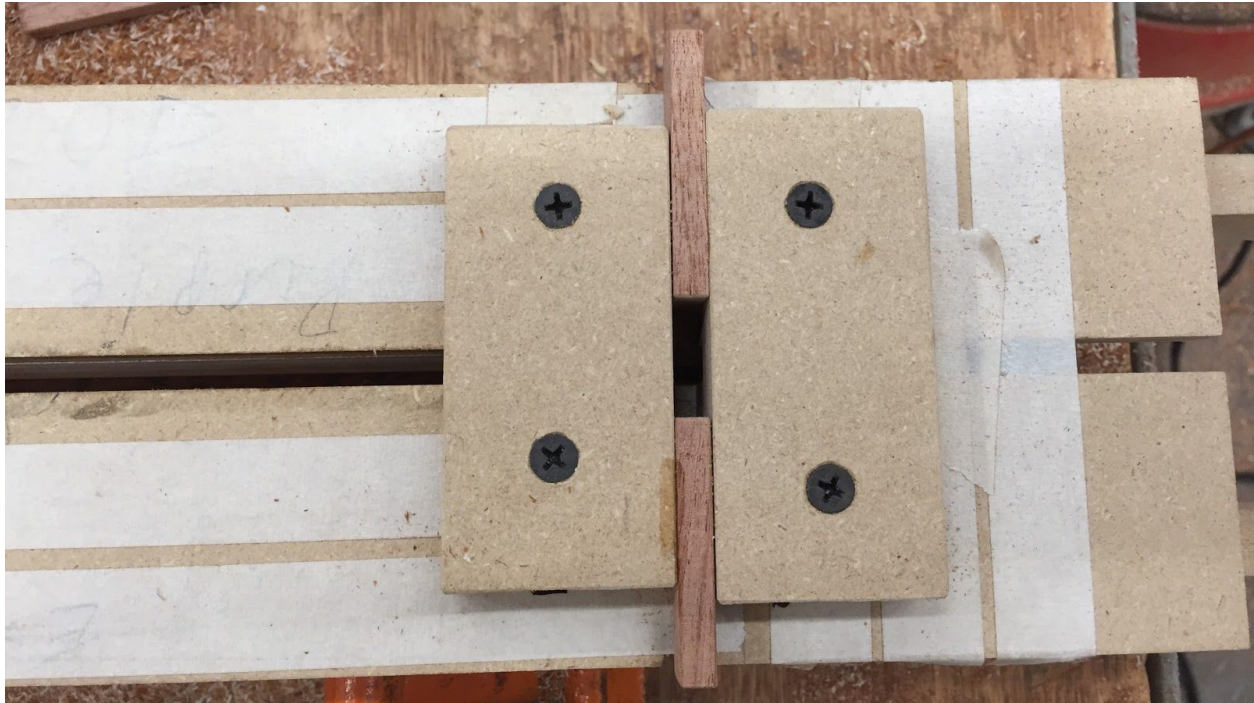

33. Finally, I drilled and counter-sunk two pilot holes in each piece of MDF and drove in some woodscrews. You may want to separate the jig from the neck blank to prevent drilling into the neck. The completed riser is shown here.



34. To prevent the bit from wandering into the channel on the peghead end, I taped in two extra pieces of channel spacer stock, shown here.



35. After completing the first couple of passes, I unscrewed the riser from the heel end of the jig, taped in another length of channel spacer stock and finished the routing to the proper depth.



36. Here is a photo of the completed routing with a good view of the round-bottomed channel.





37 a, b. The rod placed in its new home.

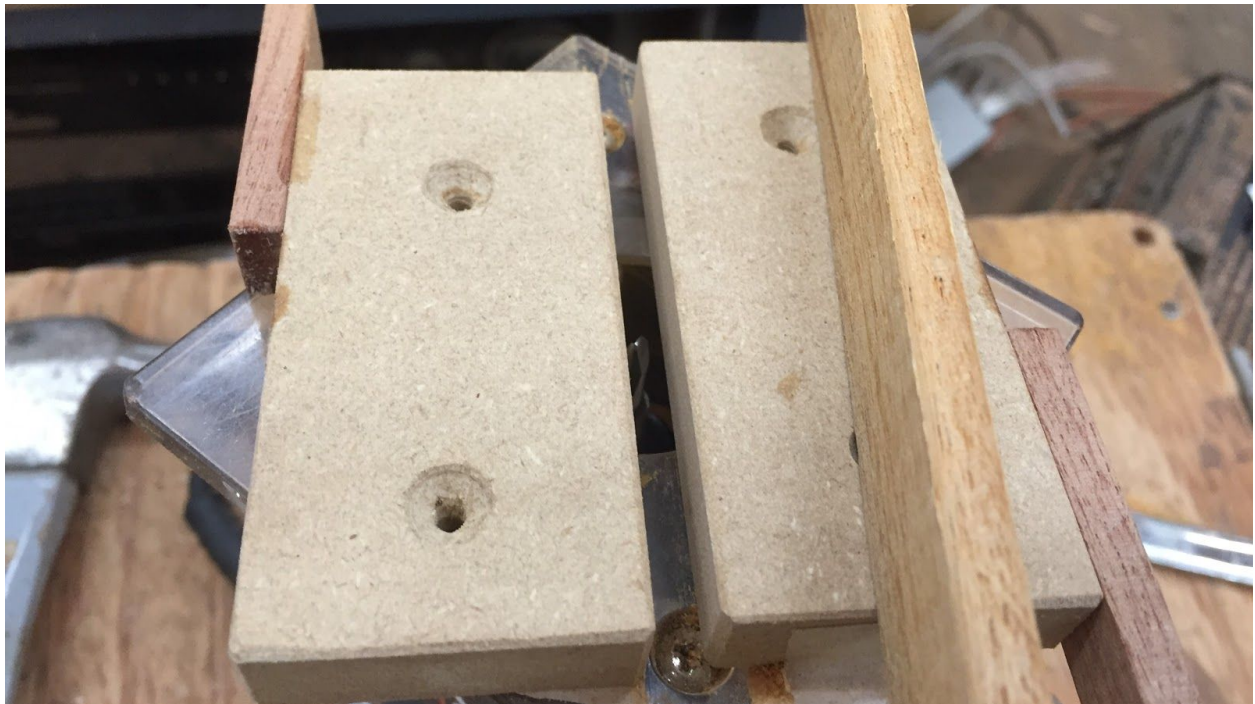

38. This time, I set up my laminate trimmer to cut a concave bottom edge for the channel-filler piece by (double-sided) taping down the MDF segments used earlier. Lower the router base to expose the round-nose bit and tape down one “fence”. Then raise the base above the tip of the bit, place the filler piece next to the “fence” and tape down the other MDF piece next to it. Lower the base to expose the tip of the bit slightly and run the wood through. Adjust the height of the bit and rout again, if need be.



39. I shaped, installed and leveled wood scraps into the voids like the last time; it was a bit simpler this time because the notches were not routed oversize. Installation is complete.

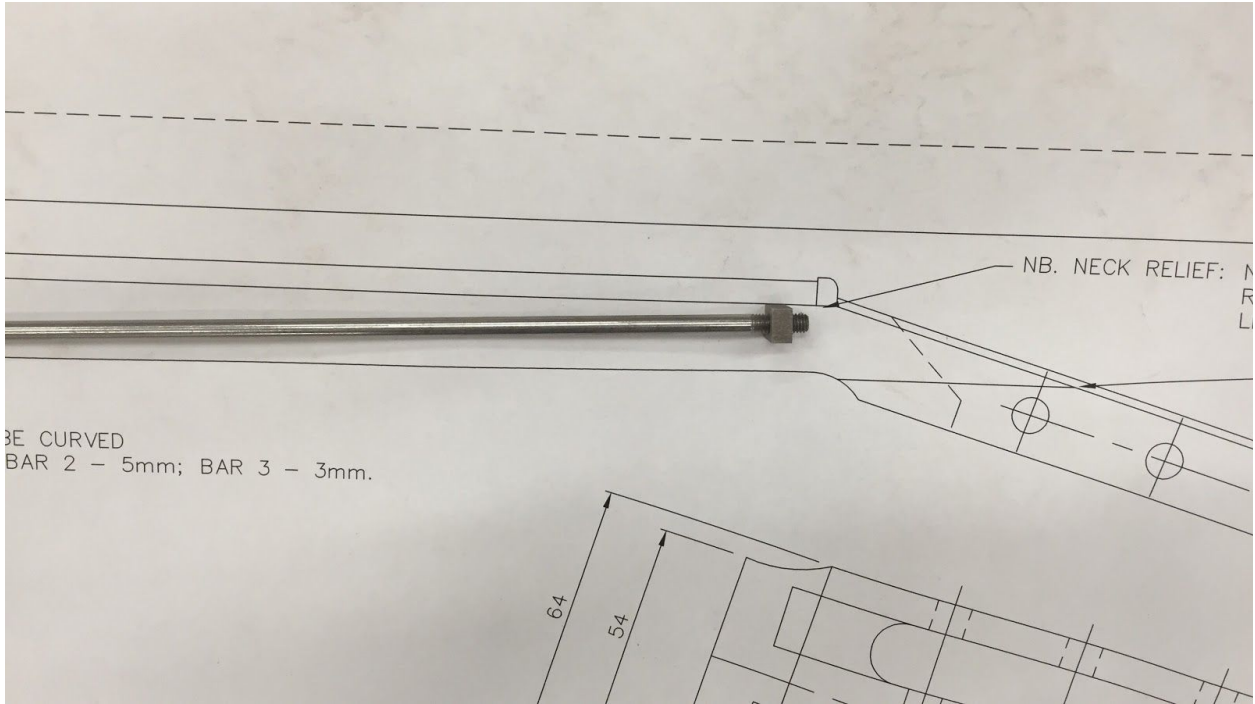

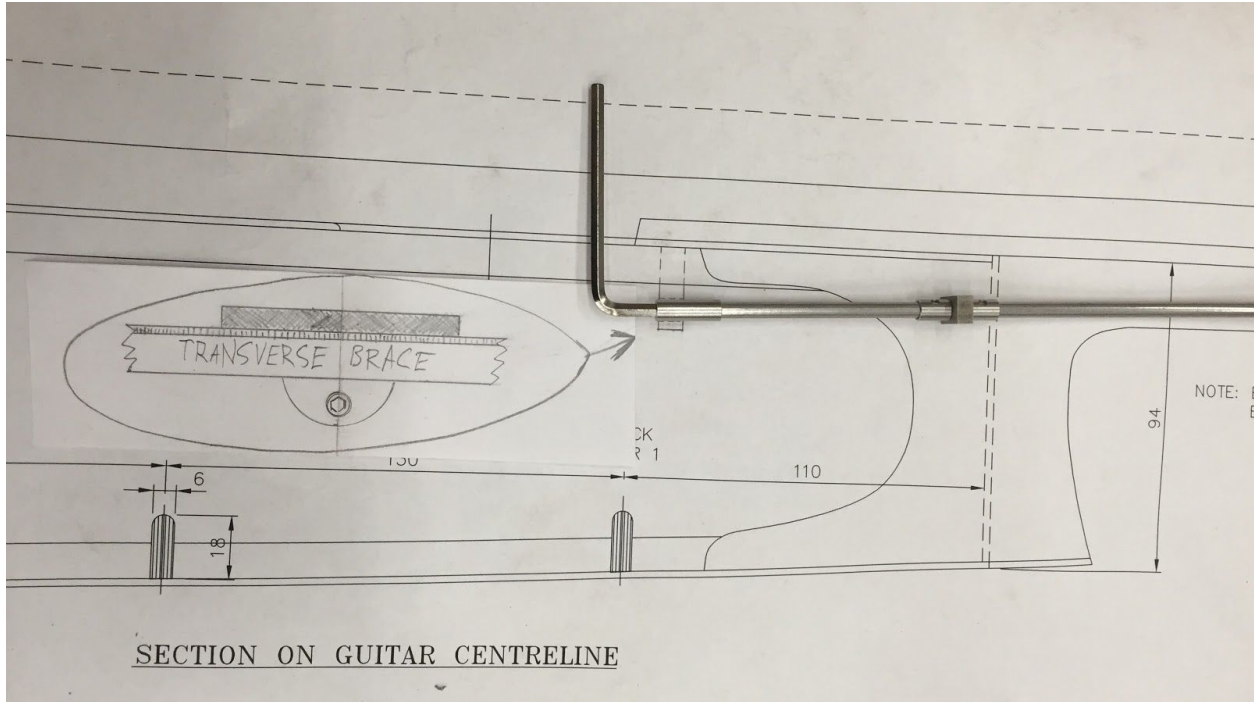

40 a, b. These photos show how the rod will be orientated inside the classical guitar neck blank. I've included this segment in the tutorial because although classical guitars do not traditionally utilize neck reinforcement, more and more classical builders are incorporating trussrods these days- and I feel that this rod is the best choice that a classical guitar builder could make if he or she decides to incorporate one.

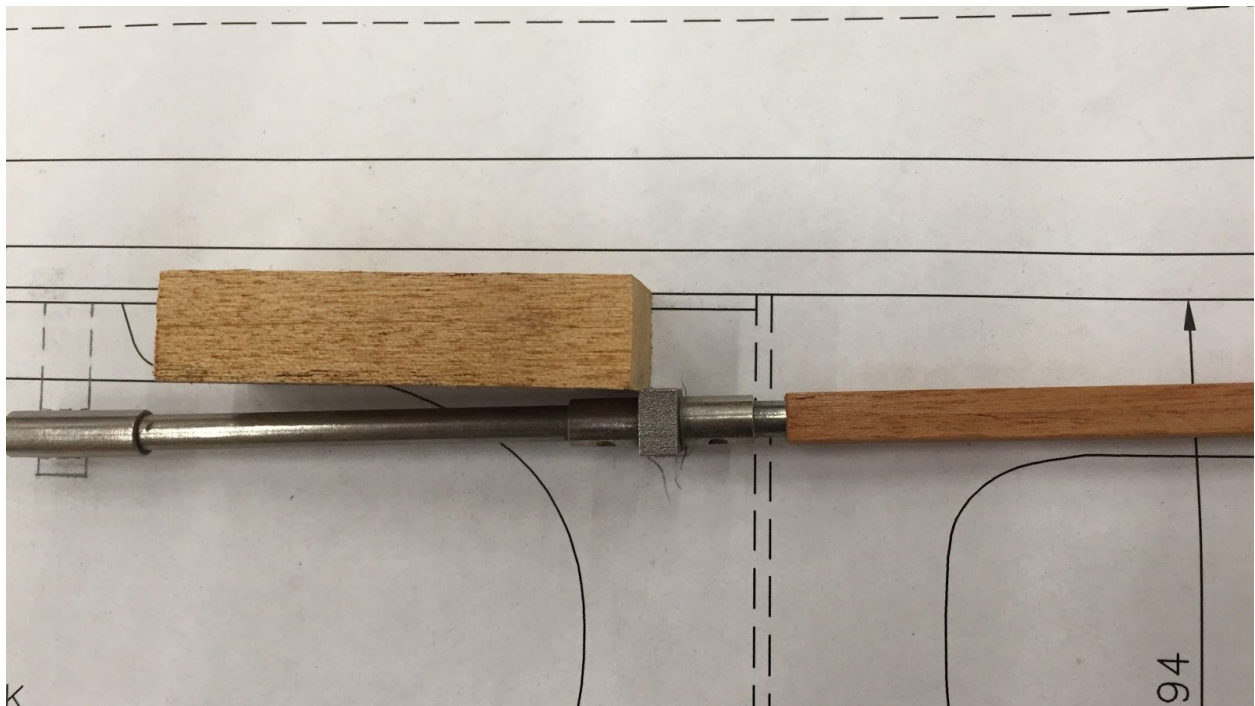

41. Here's a photo that shows the wood I am using for the spacers to be installed under the peghead end of the jig. Since this neck will be thicker than the maple necks, a can embed the rod further from the fretboard for greater efficiency of operation.



42. I disassembled the jig and reassembled it to rout the classical neck blank. I cut the spacer block in half diagonally and taped them in place. This time (as I'm sure you've already noticed), the "threaded end" of the jig will be placed at the peghead end of the neck blank.

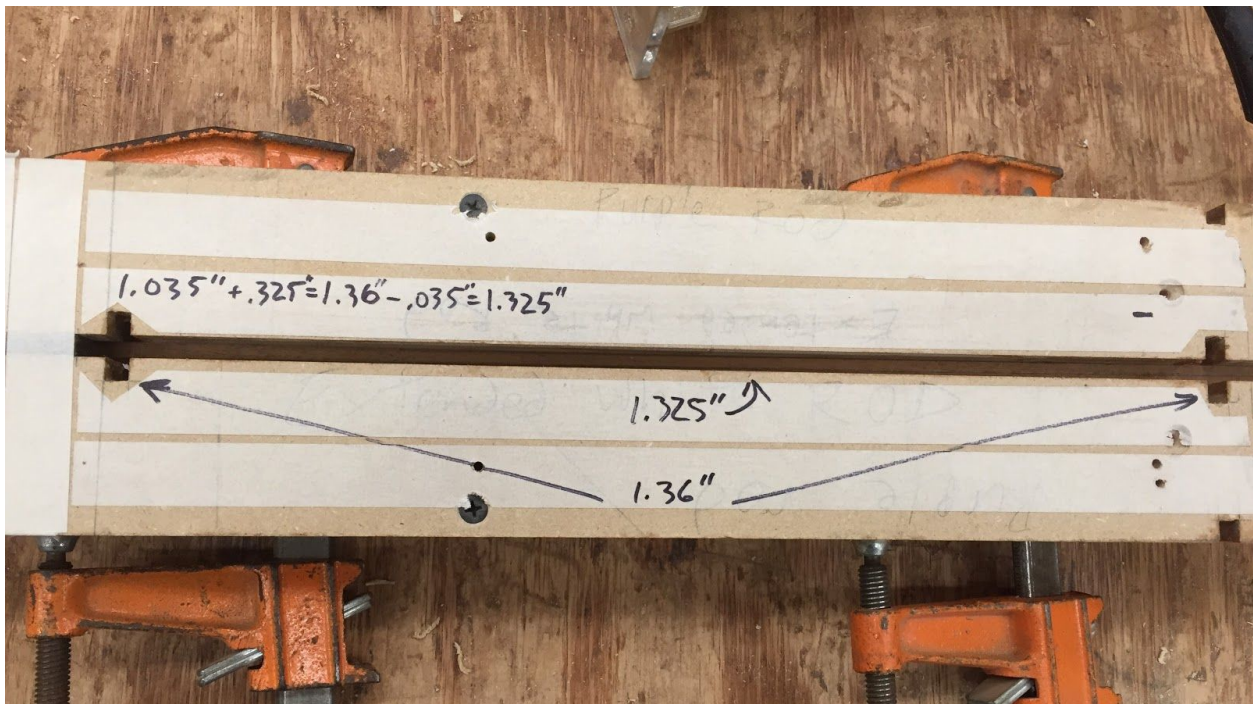

43. The jig is clamped to the neck blank, complete with math/bit depth measurement notes.



44. This is a photo of the rod sitting atop the router bit height block I made for this neck rout.



45. I didn't want the channel routing to interfere with the notches, so I screwed on these router base guides to keep the bit from meandering into the notches. Looking closely, you can see that they did their job.

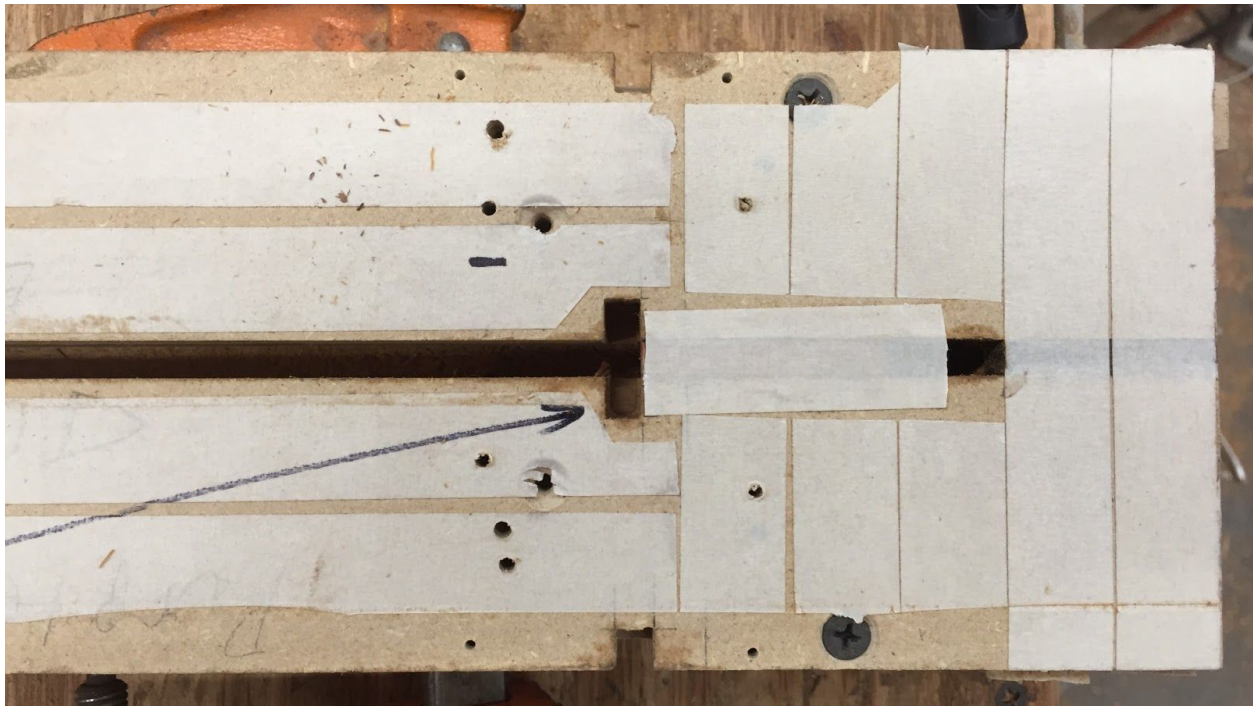

46 a, b. I then repeated the steps discussed in photos 32 to 35 for routing the endblock portion of the rout.



47. The routing is complete. Looking at the heel end at the upper-right corner of the photo, you can see that the channel reaches through the bottom of the neck blank (as expected); you can see the floor through the hole. I will continue the channel all the way through to the end of the blank using a bandsaw. Otherwise, I wouldn't be able to install the rod.



48. This photo shows the trussrod placed in the neck blank. For this build, I must bring the neck much further to completion before permanently installing the rod.



49. Lastly, the remaining photos are included to assist in explaining how you might go about routing a neck blank with only a 1/4"x 1" dado bit. Here, the jig is clamped in place and a length of wood milled to an exact fit and inserted into the main slot. The screws are there to assist in removing the wood after the next step.

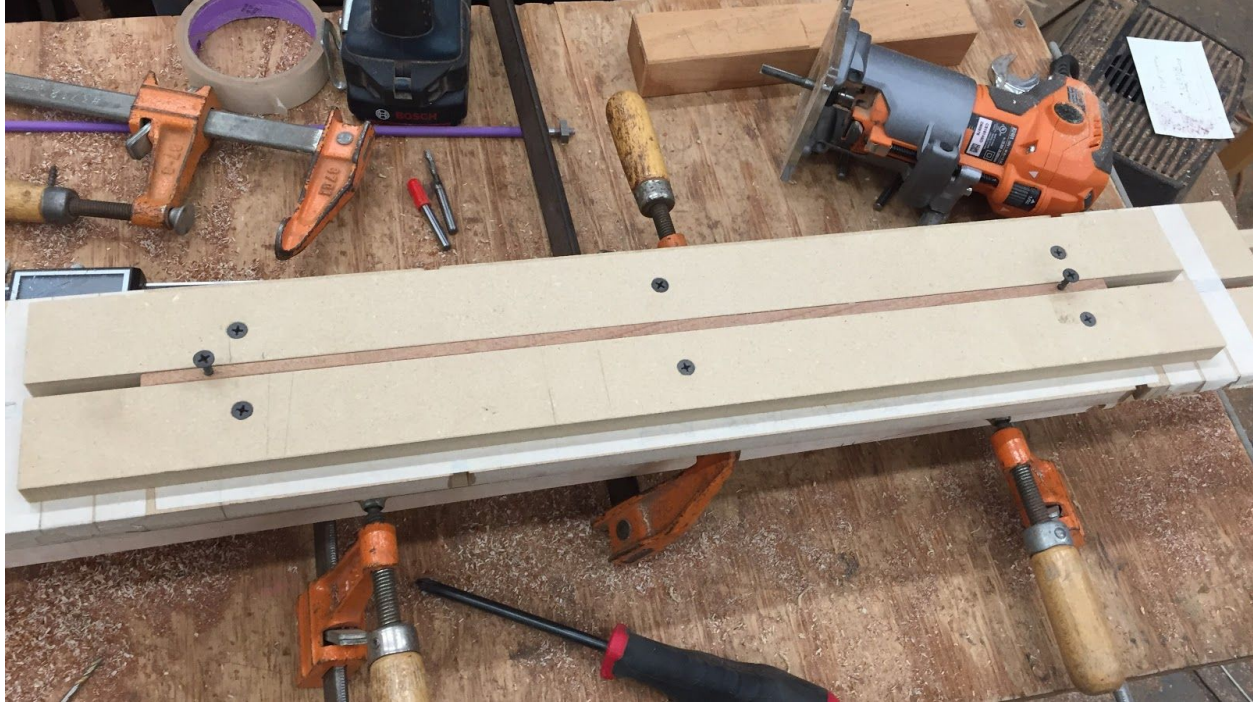

50. In this photo, two lengths of MDF are shown screwed down to the jig to elevate the router/bit for the first two or three passes.



51. Here, I removed the filler stick and butted the bottom up to the edge of the main slot to flush up the small filler piece needed to stop the travel of the router where the channel needs to end. I glue-tacked the filler wood in place and did the same thing on the other end of the jig.



52. The jig is now ready for routing the main channel. After the first two or three passes, the built up layer is removed and the remaining router passes completed. The rest of the routing steps are covered in photos 32 to 35. I hope that you find this pictorial tutorial helpful!