

kirikí

Embroidery Stitch Library

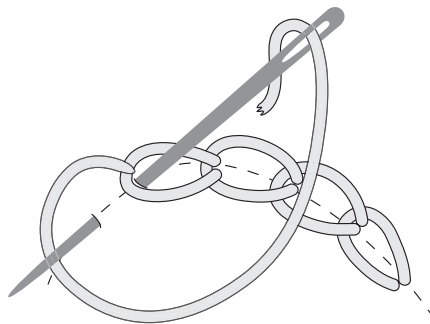

Michelle Galletta
Kiriki Press • Toronto • 2019

CONTENTS

The Basics.....	<u>3</u>
Getting Started.....	<u>6</u>
Straight Stitch & Seed Stitch.....	<u>10</u>
Backstitch.....	<u>11</u>
Fly Stitch.....	<u>12</u>
Feather Stitch.....	<u>13</u>
Fern Stitch.....	<u>14</u>
Arrowhead Stitch.....	<u>15</u>
Chain Stitch, Detached Chain & Lazy Daisy.....	<u>16</u>
Split Stitch.....	<u>17</u>
Stem Stitch.....	<u>18</u>
Buttonhole Stitch.....	<u>19</u>
Buttonhole Wheel & Scallops.....	<u>20</u>
Heavy Buttonhole Stitch.....	<u>21</u>
Satin Stitch.....	<u>22</u>
Fishbone Stitch.....	<u>24</u>
Raised Fishbone Stitch.....	<u>25</u>
Square Laid Work.....	<u>26</u>
Long & Short Stitch.....	<u>27</u>
French Knot.....	<u>28</u>
Needleweaving.....	<u>29</u>
Woven Wheel.....	<u>31</u>
Couching.....	<u>32</u>
Tassel Stitch.....	<u>33</u>
Turkey Work.....	<u>34</u>
Woven Picot.....	<u>35</u>
Bowknot Stitch.....	<u>36</u>
Detached Buttonhole Stitch.....	<u>37</u>

This booklet details all of the stitches used in **Kiriki Press D.I.Y. Embroidered Doll Kits**, along with some tips and tricks that will get you stitching beautiful dolls and any other project you'd like to embroider.

3 • *The Basics*

Hand embroidery is a craft that spans cultures and generations. It produces decorative and intricate stitches that are actually quite simple once you learn the techniques. Embroidery is a relaxing hobby so be patient as you learn how to stitch - practice really does make perfect - and always have fun. Don't be afraid to make mistakes... cut stitches out and start over when you need to.

EMBROIDERY HOOP

It's important to use a good quality hoop that won't cause the fabric to slip while working. Flimsy wooden hoops tend to do this and will require constant tightening and readjustments. If you're using the embroidery hoop from the **Starter Kit** you'll see that one side of the inner hoop reads **THIS SIDE UP**. Keep this hoop face up and place the fabric over top. Press the outer hoop down over fabric and under the lip of inner hoop. Carefully pull the fabric taut without distorting the pattern. Tighten the nut.

EMBROIDERY FLOSS

The floss that comes with the **D.I.Y. Embroidered Doll Kits** is DMC brand, a high quality cotton floss made in France that comes in a vast range of vivid colours.

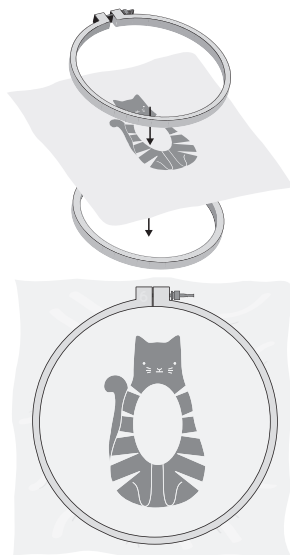

4 • *The Basics*

SEPARATING FLOSS

Most embroidery flosses, DMC included, are comprised of 6 easily separable strands that allow for various thicknesses of stitches by using a different number of strands. Once the floss is cut to your desired length, separate the floss into individual strands by pulling the number of strands you need until they are separate from the rest and smooth them out with your thumb and forefinger before threading them onto your needle.

CUTTING FLOSS

You don't want to use too long or too short of a length. Use floss at about 14" in length. The longer your floss is, the more easily it will tangle. At the same time, you don't want the floss to be too short or else you will constantly have to re-thread your needle. A quick and easy way to measure an ideal length is to pinch the end of the floss between your thumb and index finger, extend your arm and measure to the crease of your elbow.

TYING A KNOT

Before threading your needle make a knot on one end of the floss. Follow the diagram for quick and easy knots.

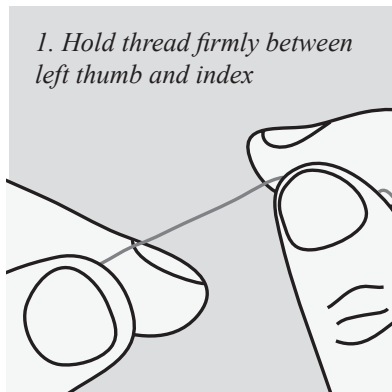

5 • The Basics

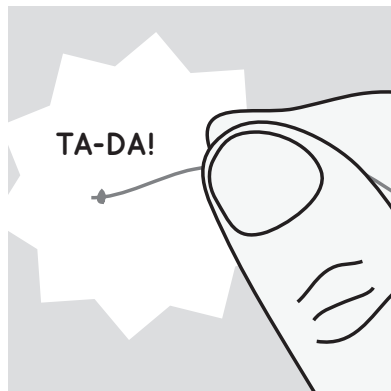
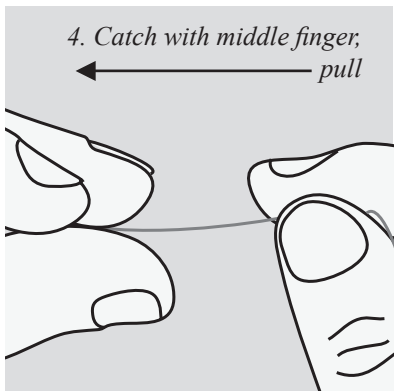
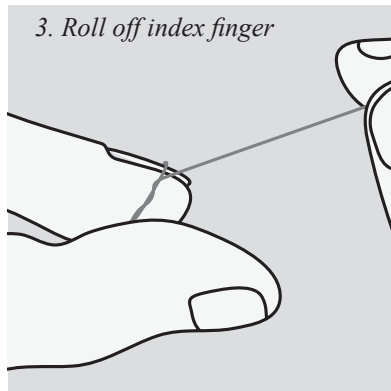
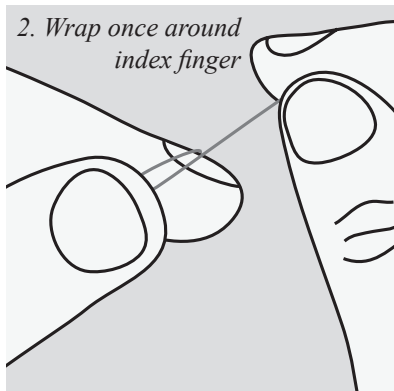

6 • Getting Started

THREADING THE NEEDLE

The **Starter Kit** comes with two embroidery needles: a no. 10 to use with 1 strand of floss and a slightly larger no. 9 to use with 2-3 strands. Using a needle threader is the easiest way to thread a needle, but if you don't have one simply pinch the thread between your thumb and forefinger, leaving only a small tip exposed, and push through the eye. Leave a 3" to 4" tail hanging on one end.

I know it's tempting, but don't lick your thread! Saliva causes corrosion and the needle will eventually lose its smooth finish, making it more likely to catch on threads or the fabric.

STARTING A STITCH

The back of an embroidery is just as important as the front! A back side filled with knots and tangled threads makes it very difficult to produce neat and beautiful stitches. For this reason, I recommend starting and stopping stitches without leaving knots. There are several ways to achieve this:

Waste Knot

The Waste Knot works best when you are stitching a line and there are no previous stitches on which to anchor your thread.

To begin, take the needle from the front to the back about 1" from your starting point,

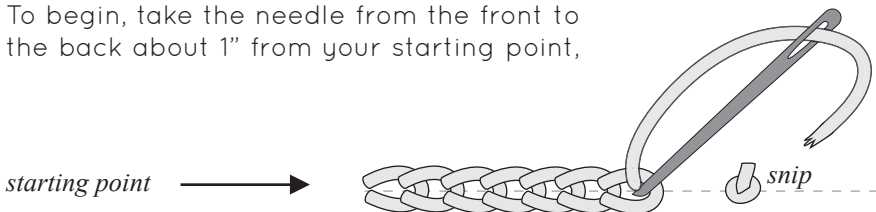

7 • Getting Started

your fabric. Take the needle through the starting point and stitch towards the knot, ensuring that each stitch helps to secure the thread on the back. Snip the knot with scissors just before reaching it.

Away Knot

The Away Knot is a good choice when you are stitching detached stitches and there are no previous stitches on which to anchor your thread. To begin, take the needle a few inches from the starting point, leaving a knot on the front side of your fabric. When you finish stitching with your thread snip the knot. Turn over your hoop and re-thread the needle with the loose piece of thread, weaving it through stitches until it is securely in place.

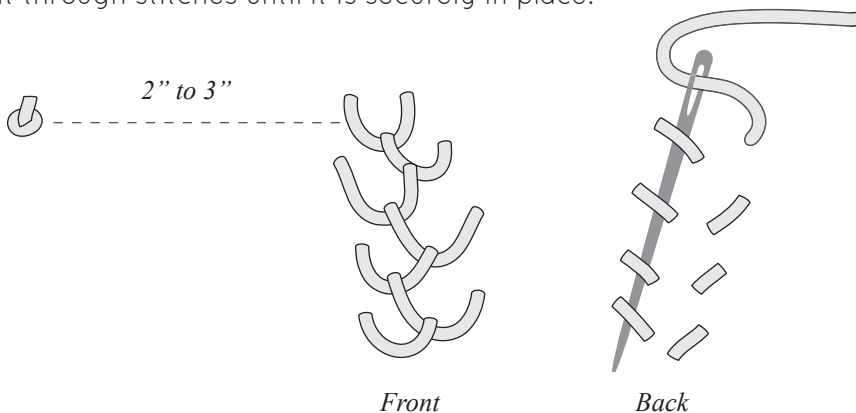

8 • Getting Started

Anchor Stitch

If you are stitching over an area that will be filled (i.e. with Satin Stitch) you can make a Straight Stitch, then a perpendicular stitch into it, securing it in place (in the shape of a 'T').

Knot & Weave

Once there are stitches to which you can anchor new thread, you can commence a new stitch with a far shorter version of the Away Knot, placed 1/4" inch away from the anchoring stitches and close to your starting point. Weave into the back of these stitches and snip the knot away once the thread is secure. Begin your new stitch.

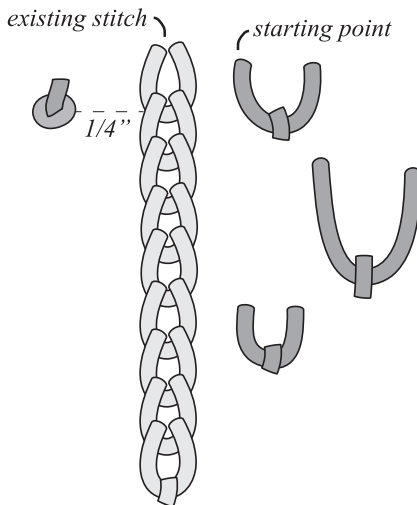

ENDING A THREAD

When you are getting close to the end of your thread leave enough so that it is easy to secure by weaving through several stitches on the back side of the embroidery. If you are halfway through a stitch do not attempt to tie on a new thread and continue stitching. Treat it as a finished stitch and commence anew with a new thread using one of the methods described in the previous section.

The Stitches

10 • *Straight Stitch, Running Stitch & Seed Stitch*

The Straight Stitch is made of single, isolated stitches. They can be worked in a straight line (Running Stitch), fill in a shape, or overlap each other. Small Straight Stitches that run in different direction to fill an area are known as Seed Stitches.

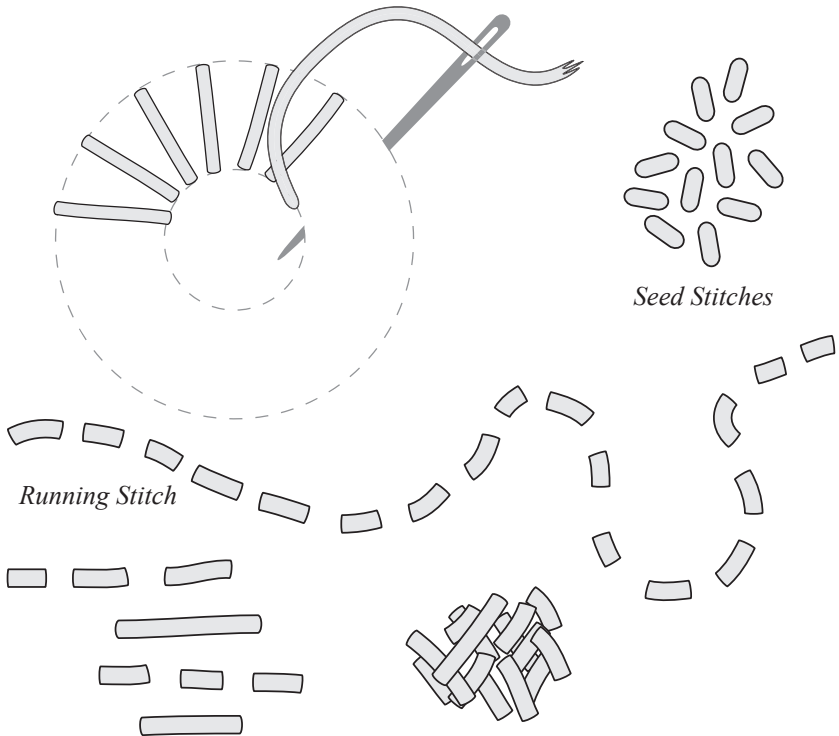

11 • *Backstitch*

Start by making a single straight stitch along your line. Come back up with your needle one stitch length over and stitch back into the line towards the first stitch. Continue this with each stitch, forming a simple, clean line. Keep each stitch length consistent.

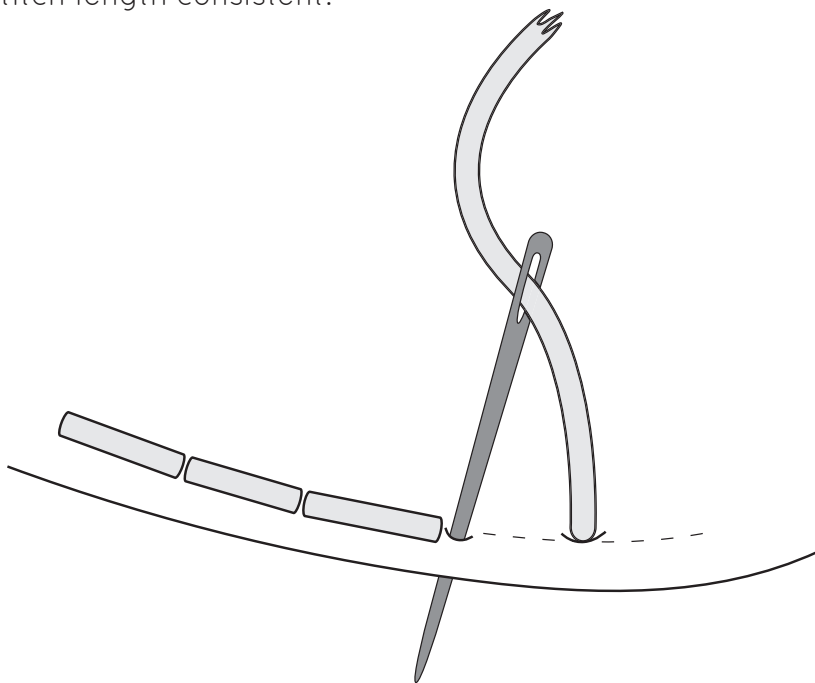

12 • *Fly Stitch*

Bring the needle through the top left at (a). Catch the thread with your thumb and insert the needle to the right (b) at the same height, a short distance away. Keeping some slack in the working thread - like a “U” hanging between (a) and (b) - take a small stitch downwards and to the centre (c) and keeping the working thread below the needle, pull through and insert the needle below the thread to anchor it (d). Varying the distance between (c) and (d) will result in a longer or shorter tail (a “Y” look versus a “V” look)

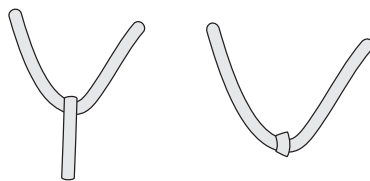
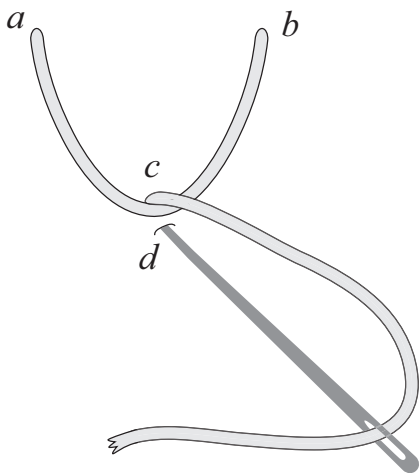

Detached Fly Stitch

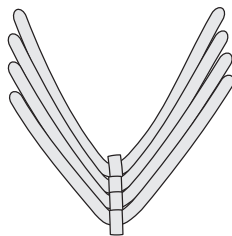

Closed Fly Stitch

13 • Feather Stitch

Follow the directions for the Fly Stitch, but instead of anchoring the stitch, move (d) to the right/left and continue catching the working thread in this manner as you move down the line.

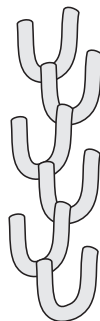
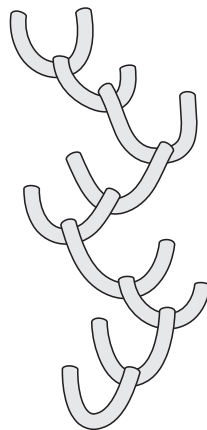
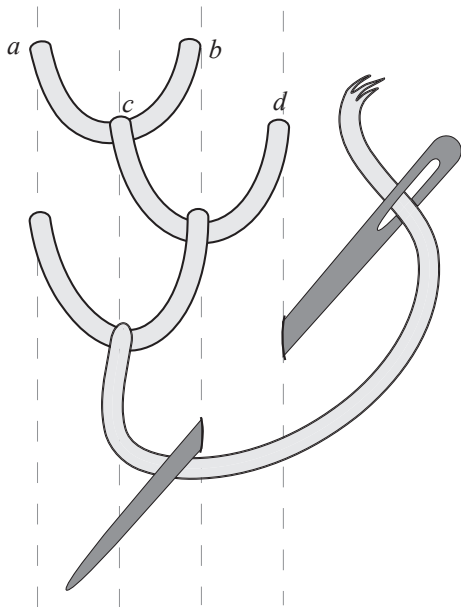

14 • *Fern Stitch*

The Fern Stitch is a simple stitch comprised of three straight stitches that radiate from a central point. To begin, make a straight stitch from bottom (a) to top (b). Exit to the left (c) and re-insert your needle at (a). Exit to the right (d) and re-insert your needle at (a). Repeat until your line is complete or move to the next location if you are making a series of Detached Fern Stitches.

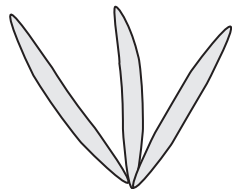
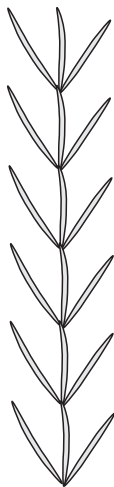
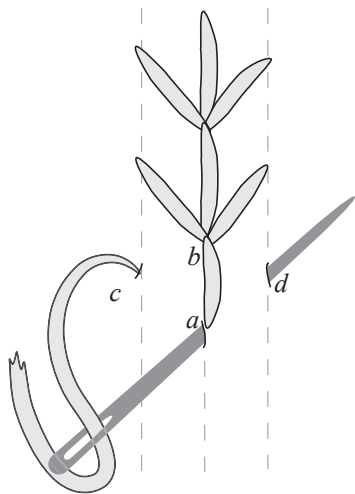

Detached Fern Stitch

15 • **Arrowhead Stitch**

The Arrowhead Stitch is a simple stitch resembling a “V”. To begin, make a straight stitch from (a) to (b). Come out through (c) and re-insert your needle at (b). A horizontal row of Arrowhead Stitches created a zig-zag pattern. Stack stitches close together vertically for a Closed Arrowhead Stitch.

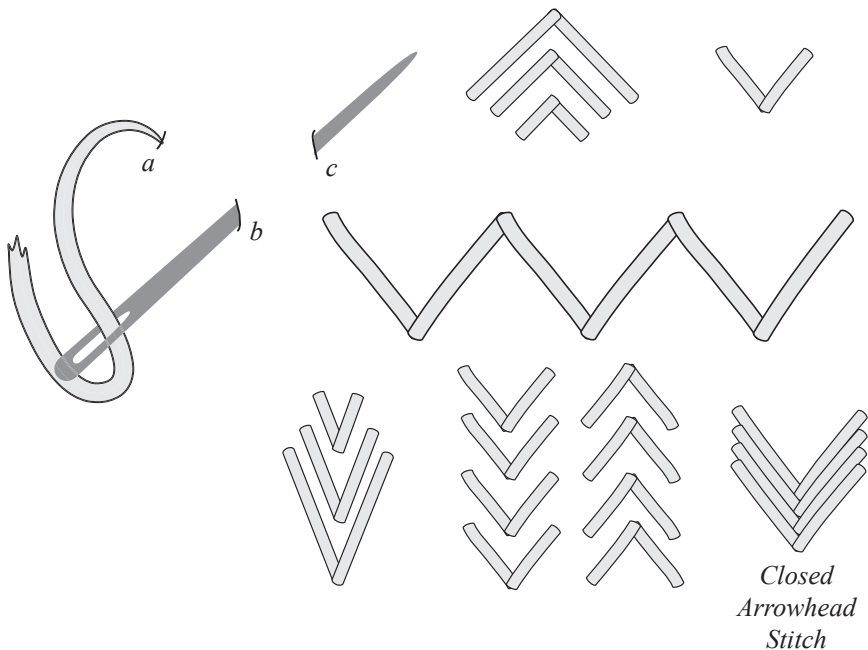

16 • *Chain Stitch, Detached Chain & Lazy Daisy*

The Chain Stitch is great for lines and curves. It's very versatile, creating not only detailed outlines, but dense fills that have a beautiful texture.

To make this stitch, bring the thread through the fabric and hold down with your left thumb. Go back through the same hole, still holding down the thread, and bring the needle back through a short distance away (1/8" or less). Once the needle is through the loop you can remove your thumb and give a light tug to tighten up the chain. Repeat.

Shorten the distance between chain "links" when going around curves for an even smoother line.

To make a Lazy Daisy (a.k.a. Detached Chain Stitch), simply follow the directions for Chain Stitch, but instead of repeating each step to form a chain, anchor each "link" with a single stitch.

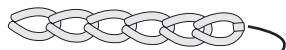
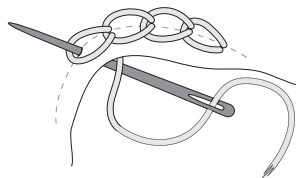
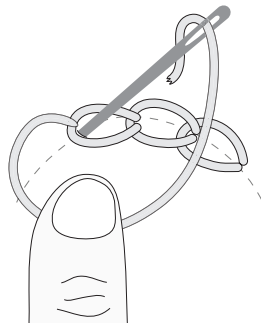

anchor with a single stitch

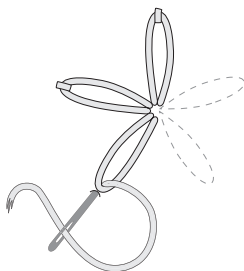
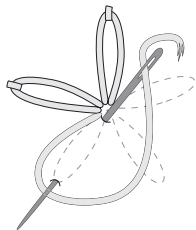

Lazy Daisy

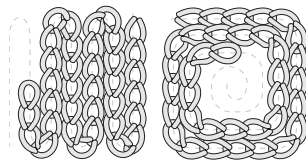

Chain Stitch fill

17 • *Split Stitch*

The Split Stitch is used for thin outlines and as padding underneath a Satin Stitch. Make a straight stitch along your line from (a) to (b). Bring the needle back through at (c), which is slightly closer to (b) than to (a). This will split the thread in half as the needle pulls through. Repeat until you come to the end of your line, finishing with a normal straight stitch.

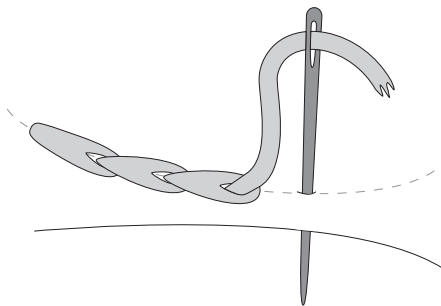
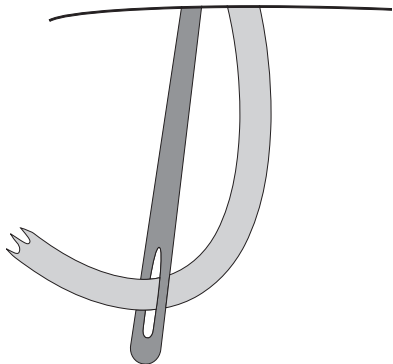
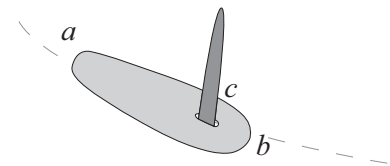

18 • *Stem Stitch*

The Stem Stitch creates a twisted rope effect, perfect for filling in straight or curved lines. It can be used to fill an area by stitching parallel lines very close to one another. To begin the Stem Stitch, come out at your starting point (a). Bring the needle out a stitch length's away (b), keeping the working thread below the needle (you can use your thumb to hold the thread down). Come out halfway between (a) and (b) at (c). Repeat these steps along the path you are stitching.

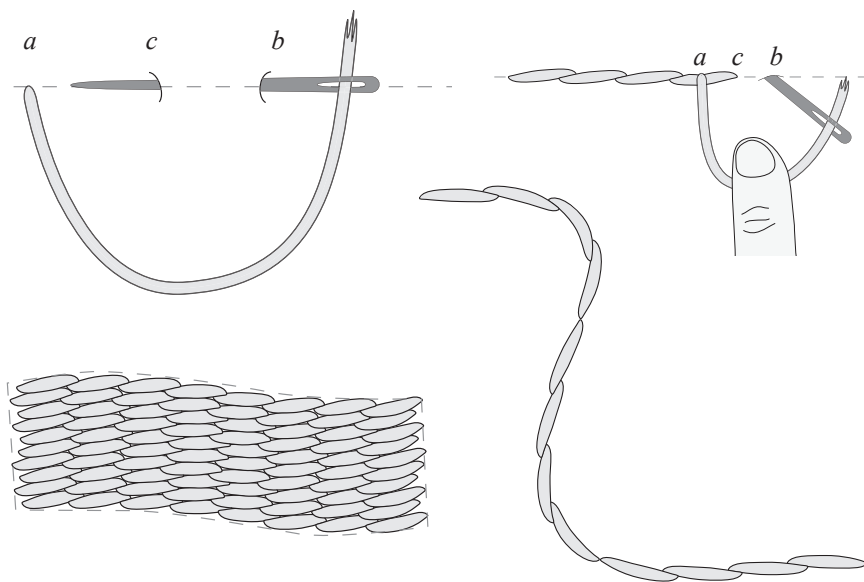

19 • **Buttonhole Stitch**

The Buttonhole Stitch (a.k.a. Blanket Stitch) creates a rope-like effect that's ideal for finishing edges of a design (you see this stitch on the edges of fleece blankets). Worked as a wheel or in scallops, it is a beautiful decorative stitch. Stitches can be made very close together or spaced out.

Bring the thread out on the lower line at (a). Insert the needle on the upper line one space to the right at (b). Catch the thread with your thumb and take a straight downward stitch to (c), ensuring that the working thread is under the needle. Repeat.

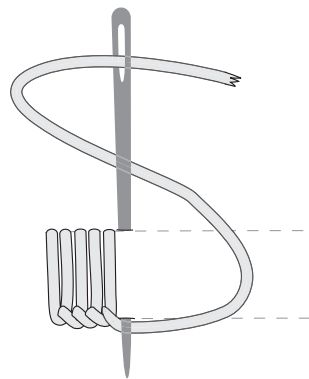

20 • *Buttonhole Wheel & Scallops*

Follow the same directions as the Buttonhole Stitch but use the outer edge of the circle as your “lower line” and a single point in the centre as the “upper line”

Buttonhole Scallops can either be worked like a Buttonhole Wheel, forming a semi-circle or quarter circle (B), or with vertical stitches that follow a shape (A).

Work rows of scallops from bottom to top.

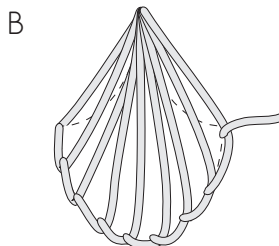
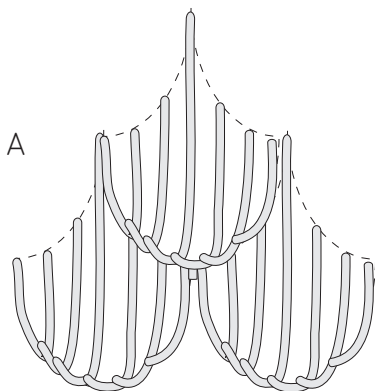
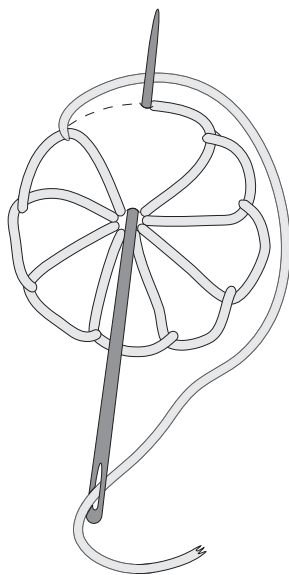

21 • *Heavy Buttonhole Stitch*

Once a Buttonhole Stitch is complete you can add a layer to emphasize the edge.

This is an example of a detached fill, where you build upon an existing stitch without going back into the fabric. The beginning and ending of this stitch are the only times that you pierce through the fabric.

Working in the same direction as the buttonhole stitch, come all the way up with your needle on the same hole where the buttonhole stitch was anchored. Keep the working thread below the stitch, and slide the needle under the thread of the first buttonhole segment (not piercing any fabric) and over the working thread to create a loop. Give a light tug to tighten. Repeat through the next segment.

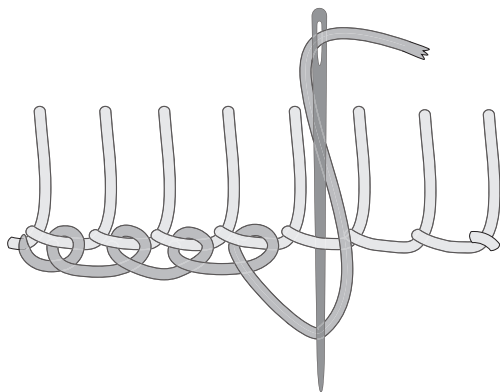

When you reach the end of the row pierce through the fabric and weave through stitches on the back side to secure in place.

When applied to a Buttonhole Wheel, it is known as a **Buttonhole Wheel Cup**, for the way it builds up around the wheel.

22 • *Satin Stitch*

Mastering the Satin Stitch is essential. It is one of the most straight forward stitches - straight stitches parallel to one another - yet possibly the most difficult to perfect. Trying to cover too large of an area as well as not padding will result in a loose stitch. Skipping over a thread in your fabric will result in crooked stitches. Using multiple strands can look messy. Some patterns (will be referred to as “Chunky Satin Stitch” in Kiriki patterns) may call for using more than one strand for design and ease, but you should know how to best execute the stitch.

Here are a few rules to live by:

1) **Use only 1 strand of floss at a time.** It will take longer to cover the area, but will result in the smooth texture and sheen that give the stitch its name

2) **Use a split stitch fill as padding.** Many diagrams show seed stitches or zig zag stitches as padding, but a 1 strand split stitch gives the support and friction necessary to ensure that no stitch comes out of place.

Padded Satin Stitch
(over Split Stitch padding)

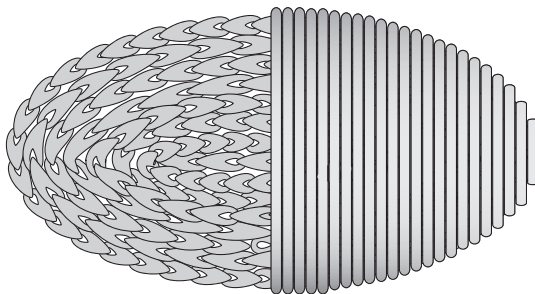

23 • *Satin Stitch*

3) **Use the fabric's woven texture as your guide.** Move through the weave of the fabric one thread at a time - this will keep the stitches perfectly parallel.

The satin stitch requires patience, finesse, and an observant eye, but once you perfect this stitch the quality look of your embroideries will increase exponentially.

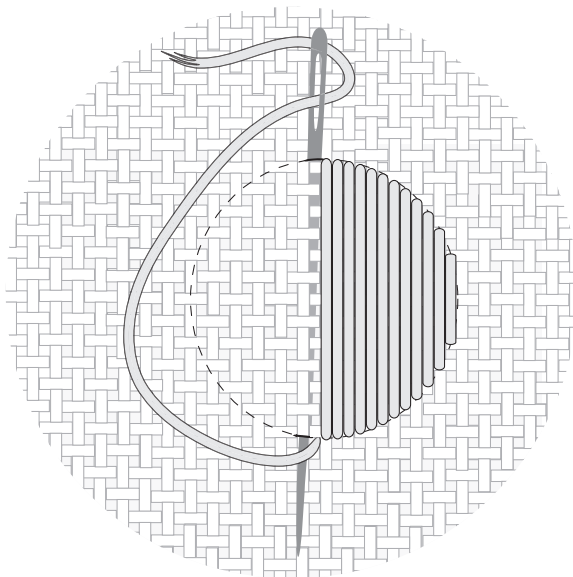

24 • *Fishbone Stitch*

The Fishbone Stitch is a series of straight stitches that cross over one another, creating a plaited line down the center of a shape. It is a fantastic stitch to use for leaves and feathers.

Begin by making a stitch from (a) to (b), about 1/4 of the way down the shape. Come up at (c), just below and to the right of (b), and go back through (d), which will cross over to the center line, up and to the left. Come out at (e) and cross over the center line, down and to the left at (f). Continue to fill out the shape following this pattern, ensuring that there is no fabric showing through between the stitches.

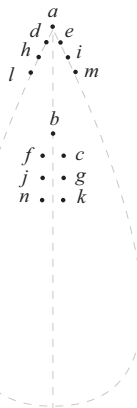

To keep the stitch direction parallel, and avoid overlapping, the points of entry down the center line should be spaced out more than the stitches around the perimeter of the shape.

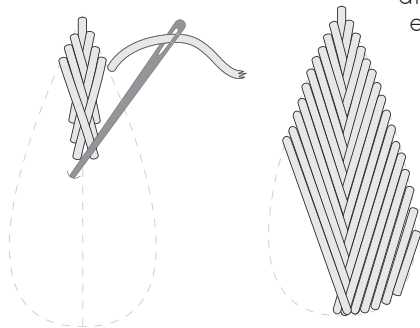

Eventually, you will run out of room to cross over down the center line. Round out the shape using straight stitches (unpadded Satin Stitch).

The diagram to the right shows the front and back of the stitch, with only one side completed with straight stitches.

25 • *Raised Fishbone Stitch*

Similar to the Fishbone Stitch, but fuller and more defined, the Raised Fishbone Stitch is a series of straight stitches that cross over one another, creating a plaited line down the center of a shape.

Begin by making a stitch from (a) to (b), about 1/2 of the way down the shape. Come up at (c), just to the left of (b), and go back through (d). Come up at (e) and cross over to (f). Continue to fill out the shape following this pattern, ensuring that there is no fabric

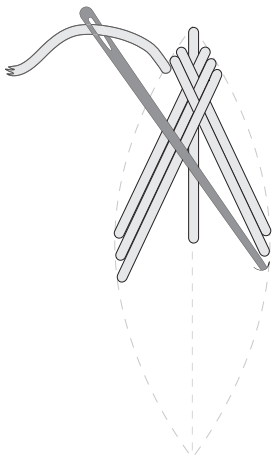
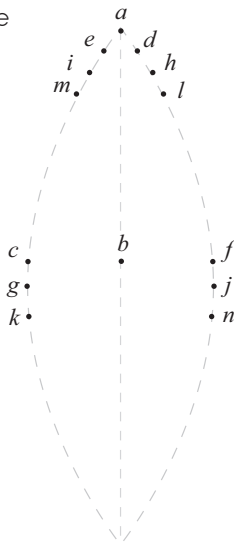

showing through between the stitches.

Eventually, you will run out of room to cross over down the center line. Round out the shape using straight stitches.

26 • *Square Laid Work*

Laid work is a very simple way to fill any shape using Straight Stitches. Begin by filling your shape with vertical or horizontal lines (A). Make a row of perpendicular stitches (B). In a uniform direction, make small diagonal stitches (Cross Stitches) where the two sets of Straight Stitches intersect (C). You can leave it as is, or make another series of diagonal stitches in the opposite direction to make a “x” (D).

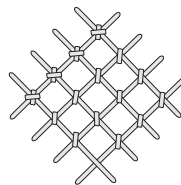
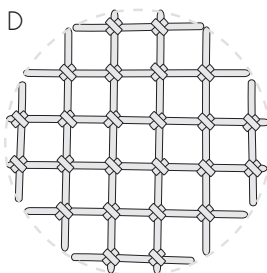
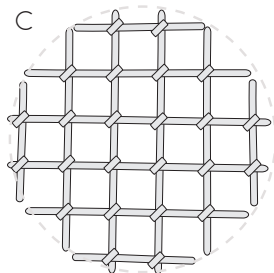
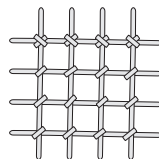
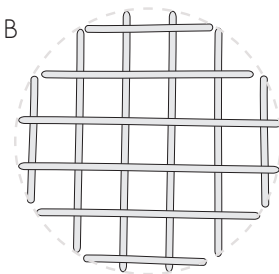
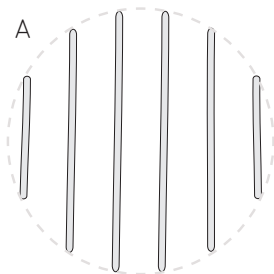

27 • *Long & Short Stitch*

The “needlepainting” stitch, the Long & Short creates gradients and colour blends. It is particularly useful to fill in areas that require realistic shading, and often used for flower petals and leaves, or to create naturalistic animal fur.

Begin by creating a set of “directional” long stitches which follow the contour of the area you need to fill in. Similar to a Satin Stitch, lay additional stitches parallel to the directional stitches, filling the area without leaving any fabric showing through.

Stagger these stitches and alternate between shorter and longer stitches at random. Switch to the next shade, and proceed in the same manner, stitching up into the previous row, to create a natural-looking blend.

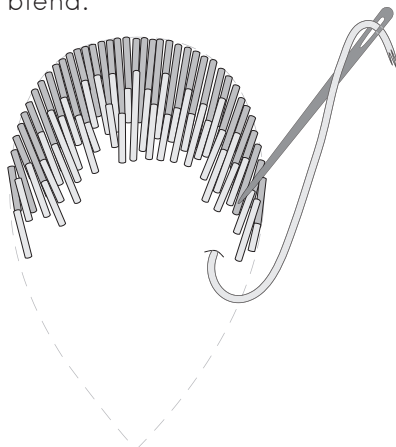
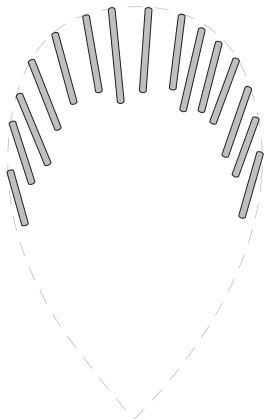

28 • *French Knot*

Bring the thread out where you want to place your knot. With your left thumb and index finger pull the thread firmly to the left. Wrap the thread around the needle twice, and angle the needle close to where the thread first emerged (but not in the exact place or it will pull through) slightly piercing through the fabric. Give the thread a tug, tightening up the coil. Slide the coil down towards the fabric and, keeping the tension, pull the needle through to the back, leaving a small knot on the surface. You can make single knots or clusters of knots by placing them close together.

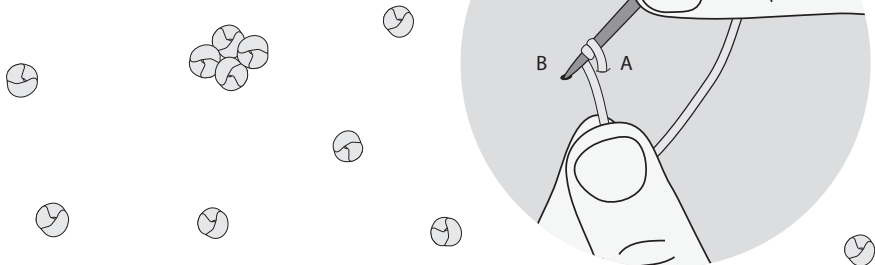
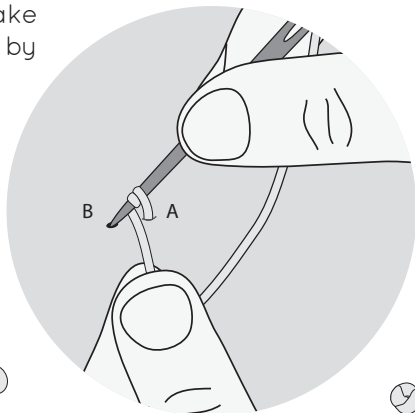
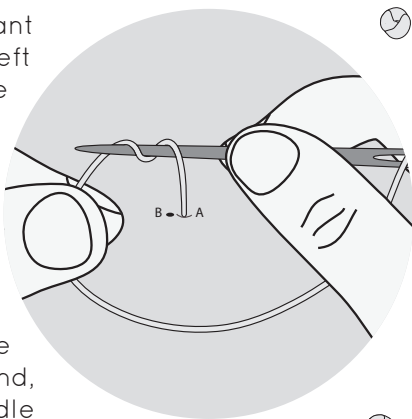

29 • Needleweaving

Needleweaving is a detached fill that, like weaving on a loom, lays vertical (warp) and horizontal (weft) threads in an under-over sequence.

Begin by making a series of vertical straight stitches, coming through the fabric at the top and bottom of the shape you're filling. Leave at least a floss width between stitches (as opposed to satin stitch where the stitches

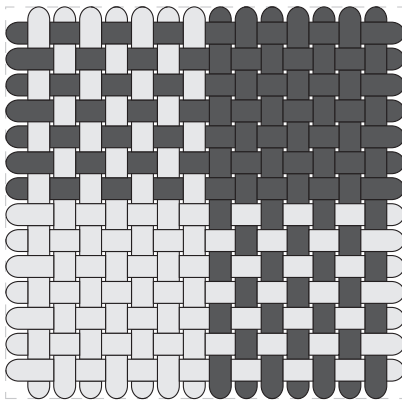
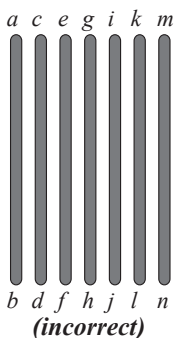
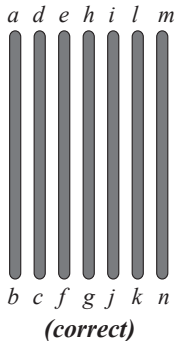

are up next to one another) Stitch to the shortest distance (see correct/incorrect diagrams on the left). Once the warp is complete, start the weft stitches. Pierce through the fabric where you want to lay the stitch, then use the blunt end of the needle (to not catch fabric) and bring the floss under/over the warp, and pierce back through the fabric at the edge of the shape you are filling.

30 • Needleweaving

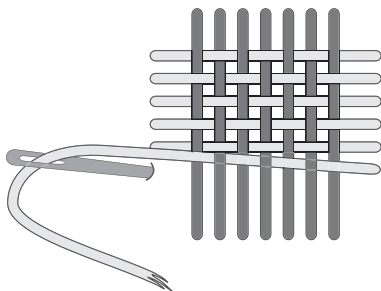
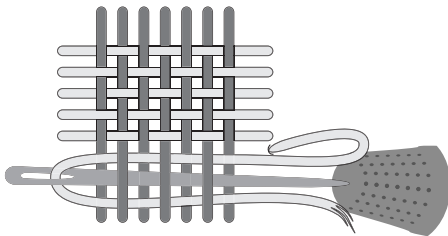
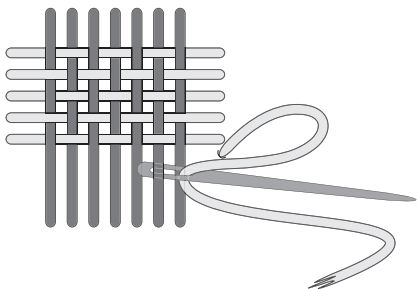

Each weft stitch should go under/over in the opposite sequence as the previous one - this is what creates the weave.

Tips:

1) A thimble is recommended to help with pushing the needle along through the stitches. Alternately, use a tapestry needle, which has a blunt tip.

2) On tight weaves, it may become challenging to weave the final weft stitch close to where the warp goes through the fabric. While the fabric is quite strong and can sustain a fair amount of pressure, don't force the floss too much or the fabric may tear. Instead, you can make small straight stitches, imitating the weaving pattern, to cover any fabric showing through.

31 • *Woven Wheel*

The Woven Wheel is a simple stitch which can be used very effectively to make beautiful flowers. Begin by making an odd number of Straight Stitches radiating from a central point, like a wheel's spokes (it helps to use a different shade of floss for the spokes). Next, bring the needle out in the center and weave through the spokes - without going through the fabric - in an over/under sequence, until the circle fills in and the spokes are no longer visible. Once complete, stitch back into the fabric under the edge of the weaving. If you run out of floss, secure it by stitching back into the fabric and start in the same position with a new thread.

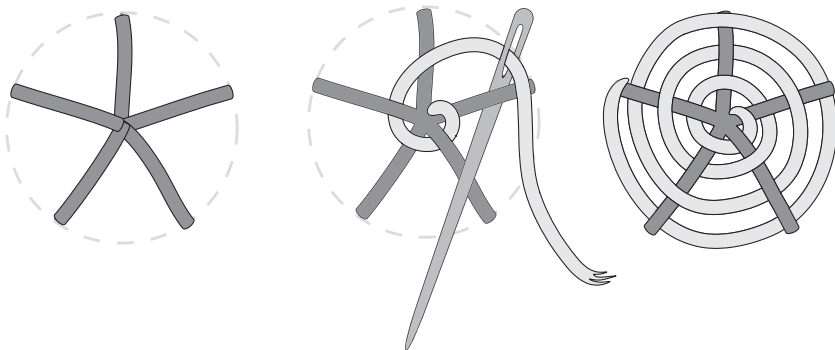

The diagram above shows a much looser version of the stitch to demonstrate the weaving, but the actual stitch will be much closer together.

32 • *Couching*

Couching is a method of securing long or curved lengths of embroidery floss by making a series of perpendicular straight stitches that tack your floss onto the fabric.

Begin by making your primary stitch, simply from (a) to (b). Using either the same colour floss or a different colour, make small, evenly spaced stitches over the primary stitch. Your floss should now be secure. If you want to shape or curve the floss, make the desired shape before going through your (b) point and adjust as necessary during couching.

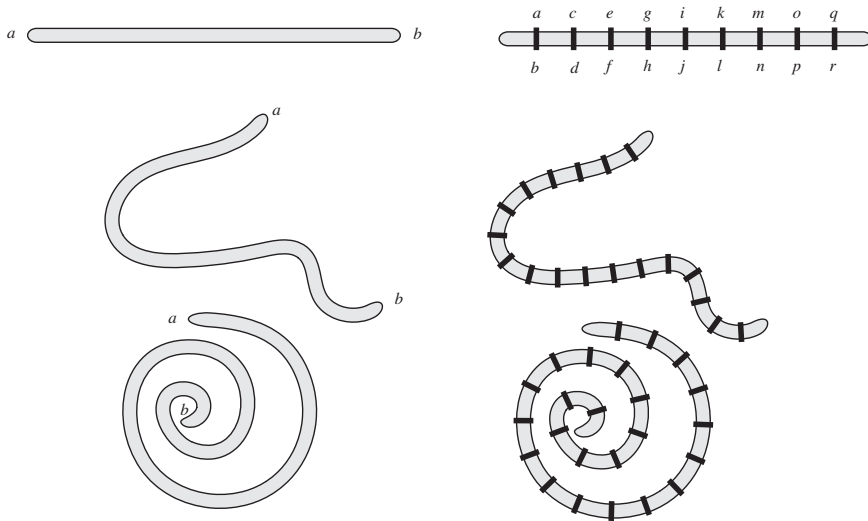

33 • *Tassel Stitch*

You can make detached looped stitches that look like mini tassels!

To begin, come out of your fabric and go back into the same hole, leaving a loop that is slightly longer than what you want your tassel to be. Make a small, straight stitch just below where the loop goes in/out of the fabric (you want to pinch the top of the loop with this stitch). If you are making multiple tassels close together, move on to the next spot and repeat. When you are finished all of the tassels, snip the loops and trim to your desired length.

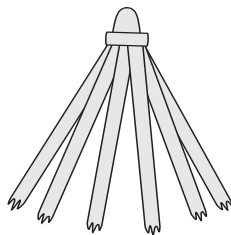

Note: The diagram below shows a single strand of floss, but use at least 3 strands

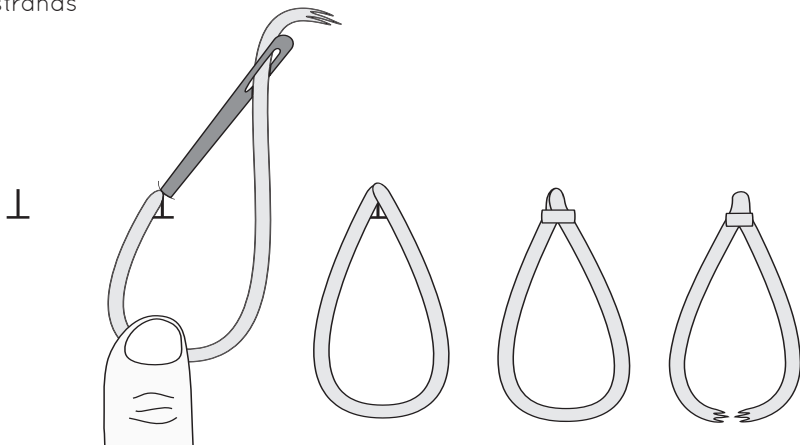

34 • Turkey Work

Turkey Work allows you to make a fluffy pile on the surface of your design. This is achieved by creating a series of loops that are locked in by a series of straight stitches. Try to keep the length between stitches to about 1/8".

To begin, DO NOT knot the end of your embroidery floss. Rather, go into your fabric at (a), leaving a small piece of the tail end (slightly longer than you want your pile). Emerge half a stitch length back at (b) and go into (c). Come up at (d), splitting through the straight stitch. Go into (e), leaving a loop (slightly longer than you want your pile), and lock the loop in by making a straight stitch from (f) to (g). Continue in this fashion until you finish your row. Finish a row by coming up through the last straight stitch. Stagger parallel rows of Turkey Work stitches until the area you want is filled. At this point snip all the loops, trim to your desired length and use your needle or a closed pair of embroidery scissors to fluff out the pile.

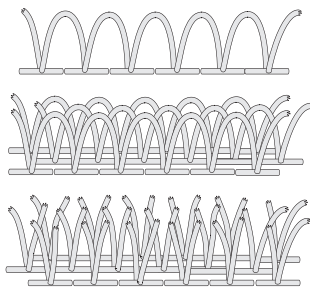

Note: The diagrams show a single strand of floss, but it's common to use at least 3 strands

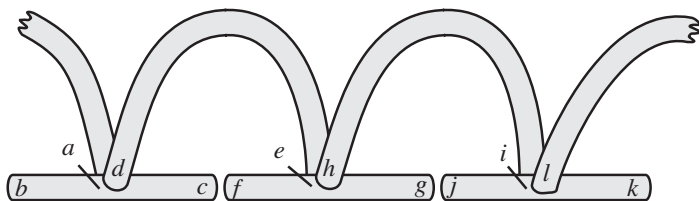

The Woven Picot is a detached stitch made by needleweaving with the assistance of a pin. To begin, determine how long you want the stitch to be and place a pin (or a needle if you don't have a pin) vertically through the fabric along the length. Determine the width you want and come up at (a). Wrap the floss over the pin, re-entering the fabric at (b).

Next, come out at (c), just to the left of where the pin emerges at the bottom. You can switch to a tapestry needle at this point or use the eye of the needle to weave so the sharp end doesn't catch on the floss or fabric. Wrap the floss around the top of the pin again and go under the floss on the right-hand side, over the center and under the floss on the left. Continue this pattern of weaving the floss under/over. Maintain an even tension and push the floss up towards the tapered tip as you weave to tighten the shape.

Once you get to the bottom of the shape, re-enter the fabric to tack it down. Remove the pin and you should have a detached triangular shape that is only attached at the bottom.

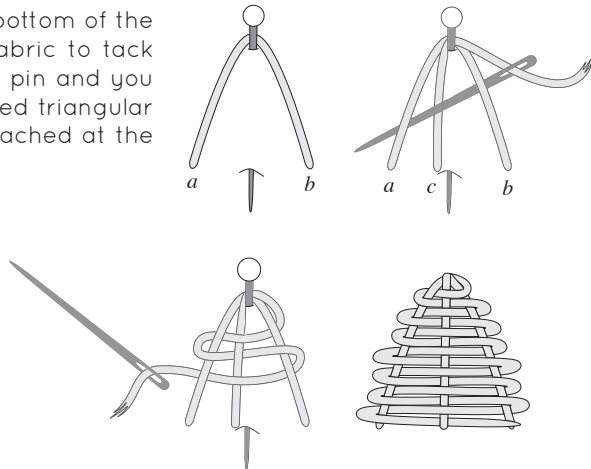

This stitch cinches a group of straight stitches in the center. Start by making a series of horizontal stitches. Pinch down the top and make a straight stitch right down the center, pinching up the bottom. Make the rest of these vertical stitches to the left and right of the center.

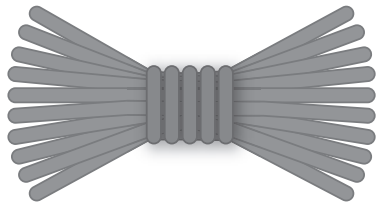
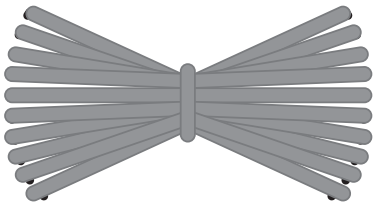
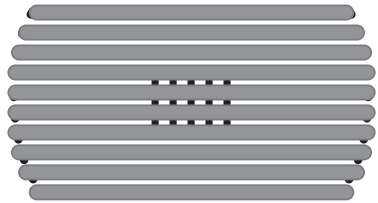

Detached Buttonhole Stitch • 37

Make a backstitch around the outline of the shape you want to fill. You can fully fill in the shape, or leave one side open to make a pocket, like on the Kangaroo doll.

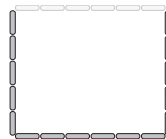

Starting on the bottom left, split through the center of the first backstitch and go back through the center of the corresponding backstitch on the opposite side. Come out in the space between the backstitches and begin making your buttonhole stitch around both the bottom backstitches and the straight line (not through the fabric.)

Once you reach the end of the row, go through the space between the backstitches (opposite side), and make another straight line from left to right. Repeat the previous step, but this time going through the loop of each buttonhole stitch (+ straight line) instead of the backstitches on the bottom. Repeat until the space is filled up. If making a 4-sided shape, make the final row through the backstitches on the top.

Tip: Use the eye of your needle and a thimble (see Needleweaving) or switch to a tapestry needle when making the buttonhole stitches

