



InfiRay Outdoor • Zoom Series • Operating Manual [www.infirayoutdoor.com](http://www.infirayoutdoor.com)



## Operating Manual

V2.0

# Zoom Series

Thermal Imaging  
Monocular

ZL38/ZH38/ZH50



**IRay Technology Co., Ltd.**

Add: 11th Guiyang Street, YEDA, Yantai, P.R. China

Tel: 0086-400-998-3088

Email: [infirayoutdoor@infiray.com](mailto:infirayoutdoor@infiray.com)

Web: [www.infirayoutdoor.com](http://www.infirayoutdoor.com)

# IMPORTANT SAFETY INFORMATION

## Environmental influences

**WARNING!** Never point the lens of the device directly at intense heat sources such as the sun or laser equipment. The objective lens and eyepiece can function as a burning glass and damage the interior components. The warranty does not cover damage caused by improper operation.

## Risk of swallowing

**Caution:** Do not place this device in the hands of small children. Incorrect handling can cause small parts to come loose which may be swallowed.

## Safety instructions for use

- Handle the device and Battery Pack with care: rough handling may damage the Battery Pack.
- Do not expose the device to fire or high temperatures.
- Only use the battery charger included in the delivery package.
- The battery capacity decreases when operated in a cold ambient temperature. This is not a fault and occurs for technical reasons.
- Always store the device in its carrying bag in a dry, well-ventilated space. For prolonged storage, remove the batteries.
- Do not expose your device to extreme temperatures lower than  $-20^{\circ}\text{C}$  and higher than  $+50^{\circ}\text{C}$ .
- The product shall only be connected to a USB Type C interface.
- If the device has been damaged or the battery is defective, send the device to our after-sales service for repair.

## Safety instructions for the power supply unit

- Check the power supply unit, cable and adapter for visible damage before use.
- Do not use any defective parts. Defective components must be replaced.
- Do not use the power supply unit in wet or humid environments.
- Only use the original cable provided with the battery charger.
- Do not make any technical modifications.

For further information and safety instructions, please refer to the Operation Instructions provided. This is also available on our website in the download center: [www.infirayoutdoor.com](http://www.infirayoutdoor.com).

## Disposal of batteries



In the European Union, this symbol indicates that the battery used in this product may not be disposed of in domestic waste and must be collected for disposal separately. When returning used batteries, please use a collection system that may exist in your country.

The materials and substances in the batteries may

have a detrimental impact on health and the environment.

By depositing empty batteries at a recycling facility, you are contributing to the protection, maintenance and improvement of the quality of our environment.

Please only return discharged batteries.

The battery used does not contain mercury, cadmium or lead in quantities exceeding the limits defined in Directive 2006/66/EC.

### **User information on the disposal of electrical and electronic devices (private households)**



The WEEE symbol on products and/or accompanying documents indicate that used electrical and electronic products must not be mixed with ordinary household waste. For proper treatment, recovery and recycling, take these products to the appropriate collection points where they will be accepted without charge. In some countries, it may also be possible to return these products to your local retailer when you purchase a corresponding new product. The proper disposal of this product serves to protect the environment and prevents possible harmful effects on human beings and their surroundings, which may arise as a result of incorrect handling of waste.

More detailed information on your nearest collection point is available from your local authority. In accordance with state legislation, penalties may be imposed for the improper disposal of this type of waste.

### **For business customers within the European Union**

Please contact your dealer or supplier regarding the disposal of electrical and electronic devices. He will provide you with further information.

### **Information on disposal in other countries outside of the European Union**

This symbol is only applicable in the European Union. Please contact your local authority or dealer if you wish to dispose of this product and ask for a disposal option.

### **Intended use**

The device is intended for displaying heat signatures during nature observation, remote hunting observations and for civil use. This device is not a toy for children.

Use the device only as described in this instruction manual. The manufacturer and the dealer accept no liability for damages which arise due to non-intended or incorrect use.

### **Function test**

- Before use, please ensure that your device has no visible damage.
- Test to see if the device displays a clear, undisturbed image.
- Check that the settings for the thermal imaging monocular are correct. See the notes in the section 9 Power On and Image Settings.

### **Installing/removing the battery**

The ZOOM series thermal imaging monocular is equipped with a Battery Pack. The Battery Pack can be moved and charged, referring to the section 7 Battery Pack for details.

# 1 Specification

Model	ZL38	ZH38	ZH50
<b>Detector Specifications</b>			
Type	Uncooled Vox		
Resolution, pixels	384×288	640×512	
Pixel, μm	12		
NETD, mK	≤ 25		
Frame Rate, Hz	50		
<b>Optical Specifications</b>			
Objective Lens, mm	19/38	19/38	25/50
F-number	0.9/1.2	0.8/1.0	0.88/1.1
Field of view, degree	13.9 × 10.4 / 6.9 × 5.2	22.9 × 17.2 / 11.5 × 8.7	17.5 × 13.1 / 8.7 × 6.6 /
Optical Magnification, ×	2.7~21.3	1.6~12.8	2.2~17.6
Digital Zoom	1× / 2× / 3× / 4×		
Exit Pupil Distance, mm	20		
Exit Pupil Diameter, mm	5.5		
Diopter, D	-5 ~ +5		
Detective range, m (Target size: 1.7m × 0.5m, P(n)=99%)	987/ 1974	987 / 1974	1298 / 2596
<b>Display</b>			

Type	FHD OLED		
Resolution, pixels	1440×1080		
Dimension, inch	0.4		
<b>Battery</b>			
Battery	Li-ion Battery Pack / 4400mAh / DC 3.7V		
Service Voltage, V	3 ~ 4.2		
External Voltage, V	5 (Type C USB)		
<b>Physical Specifications</b>			
Max. Operation time (t=22°C), h*	12	10	
Memory Capacity, GB	32		
Operating Temperature, °C	-20 ~ +50		
Weight, g	540	580	650
Dimension, mm	190×65×60	190×65×60	195×65×60

- ★ The actual operating time depends on the density of Wi-Fi use, photographing, video recording, etc.
- Improvements may be made to the design and software of this product to enhance its features;
- If there is any change to the technical specifications of the product, it will be made without prior notice to the customer.

## 2 Package Contents

- ZOOM Series Thermal Imaging Monocular
- Portable bag
- IBP-1 Battery Pack × 2
- IBC-1 battery charger for Battery Pack
- Power adapter
- Data cable
- Neck Strap
- Wrist strap
- Lens cleaning cloth
- Quick Start Guide

## 3 Description

The ZOOM series thermal imaging monocular is a thermal imaging handheld product integrating thermal observation, hotspot tracking, photographing and video recording, Wi-Fi connection, etc. The dual-FOV lens enables fast manual FOV switchover. You can use the large FOV for target search, and then use the small FOV for target confirmation after identifying a target. This enormously facilitates the target search. Adopting the principle of thermal imaging, it does not need external light sources and is not affected by strong light. You can use it to observe objects hidden behind such obstacles as branches, tall grass, and shrubs, regardless of the night or the day with harsh weather (such as rain, snow, fog, and haze). It can be widely applied in night hunting, observation, geographical positioning, searching, and rescuing operations.

## 4 Features



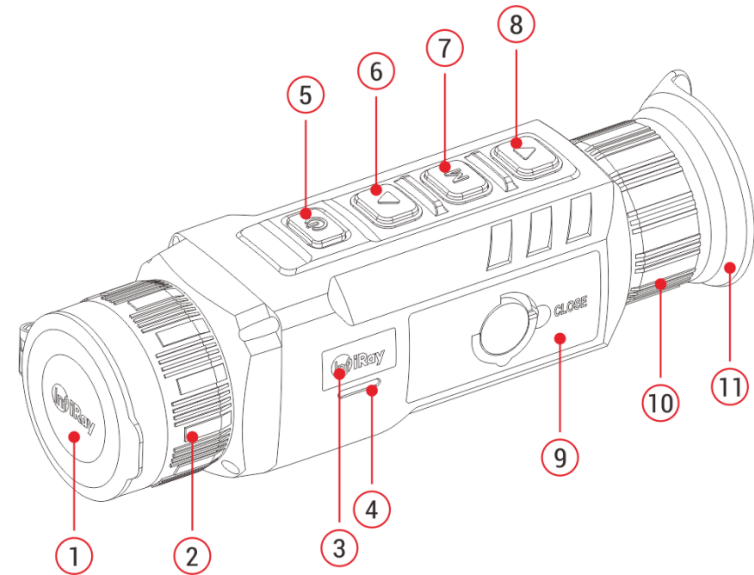

- Dual-FOV lens
- 12μm self-developed detector
- High image quality
- FHD OLED (1440×1080)
- Rechargeable Battery Pack for quick replacement
- 50Hz high frame rate
- Eyepiece supporting 20× zoom
- Digital zoom: 1×/2×/3×/4×
- Built-in 32G memory space, supporting photographing and video recording
- Built-in Wi-Fi module, supporting InfiRay outdoor App
- Built-in digital compass and motion sensor
- Ultraclear mode
- Supporting PIP, defective pixel correction, and other functions
- Convenient operation interface

## 5 Components and Buttons



- |                         |                    |
|-------------------------|--------------------|
| 1. Lens cap             | 7. Menu (M) button |
| 2. Lens focus ring      | 8. Down button     |
| 3. Status Light         | 9. Battery Pack    |
| 4. Microphone/Altimeter | 10. Eyepiece       |
| 5. Power (P) button     | 11. Eyeshade       |
| 6. UP button            |                    |

## 6 Button Operations

Button	Current Status	Short Press	Press and Hold
<b>Power button</b> 	Powered off	—	Power on the device
	Home screen	Standby the device	Power off the device
	Standby mode	Wake up the device	—
	Main menu interface	Return to the upper menu without saving changes	—
	Defective pixel correction interface	Add/delete defective pixels	—
<b>Up button</b> 	Home screen	Digital zoom	Turn on/off the PIP function
	Menu interface	Navigation upwards	—
<b>Menu button</b> 	Home screen	Open the shortcut menu	Go to the main menu
	Shortcut menu interface	Switch and confirm parameters	Save and back to the home screen
	Main menu interface	Enter the submenu / Switch and confirm the parameters	
	Defective pixel correction interface	Confirm selection / Save the position	—
<b>Down button</b> 	Home screen	Take a photo	Start a video recording
	Menu interface	Navigation downwards	—
	Video recording	Take a photo	Stop and save the video
<b>Up + M buttons</b>	Home screen	—	Turn on/off the stadiametric rangefinder
<b>Down + M buttons</b>	Home screen	—	Turn on/off hotspot tracking function

# 7 Battery Pack

The ZOOM series uses the rechargeable lithium-ion Battery Pack IBP-1, which has a battery life of 10 hours. Please charge the Battery Pack before first use.

## Method 1: Charging with Battery Charger

- Align the pins **(A)** of the Battery Pack **(9)** with the groove **(B)** of the battery charger **(13)**, and insert the Battery Pack **(9)** into the battery charger **(13)**.
- Connect the Type-C plug of the data cable **(14)** to the port **(C)** of the battery charger **(13)**.
- Connect the other plug of the data cable **(14)** to the USB port of the power adapter **(15)**.
- Insert the power adapter **(15)** to a 100V - 240V power socket **(16)** to charge the Battery Pack.
- Upon installation, the LED indicator **(D)** on the Battery Pack charger **(13)** will start to glow or blink.
  - If the indicator is steady red, the Battery Pack is being charged.
  - If the indicator turns green, the Battery Pack is fully charged.
  - If the indicator blinks red, the battery charging holder is connected to the power source but there is no installed Battery Pack.

- After fully charged, remove the Battery Pack from the battery charger **(13)**.

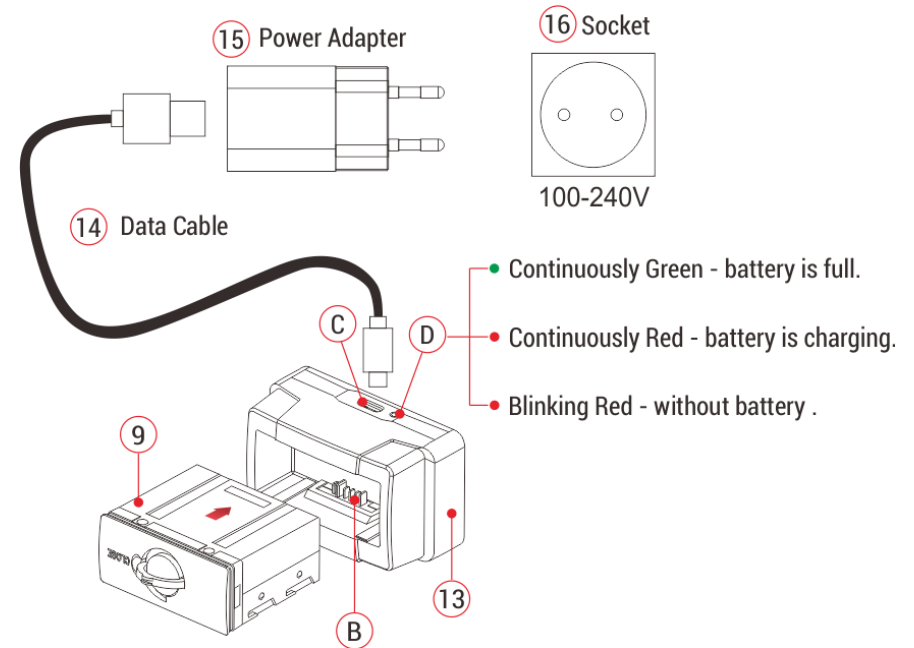

## Method 2: Charging with Type-C Port

- Open the Type-C port cover **(17)** on the bottom of the Zoom series.
- Connect the Type-C end of the data cable **(14)** to the Type-C port **(17)**.
- Connect the other end of the data cable **(14)** to the power adapter **(15)**.
- Plug the adapter into a 100-240v power socket **(16)** for charging.
- The battery icon will be changed to the charging icon  on the display.
- During charging the Battery Pack with the Type C port, the status light



(3) on the Zoom series will change also to display the battery status.

- If the status light is steady orange, the Battery Pack is being charged.
- If the status light turns green, the Battery Pack is fully charged.

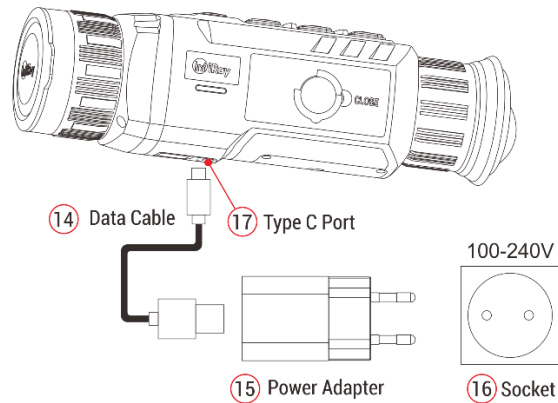

## Battery Pack Installation

- Pull out the ring-pull (12) from the Battery Pack (9), rotate it clockwise until it is in the horizontal direction with the Battery Pack (9).
- Align the pins (A) of the Battery Pack (9) with the groove of the device to install the Battery Pack (9) into the Zoom series thermal monocular.
- When the Battery Pack (9) is fully inserted into the case of the Zoom series thermal camera, rotate the ring-pull (12) 90 degrees counter-clockwise to lock the Battery Pack (9). The ring-pull (12) is in the vertical position.

- Upon installation, flip down the ring-pull (12). When the bulge on the ring-pull (12) points to 'CLOSE' on the Battery Pack (9), the Battery Pack (9) is installed.
- The Zoom series can only be powered by this Battery Pack (9). If other Battery Packs are used, it may cause irreparable loss, damage the device, and even may cause fire.

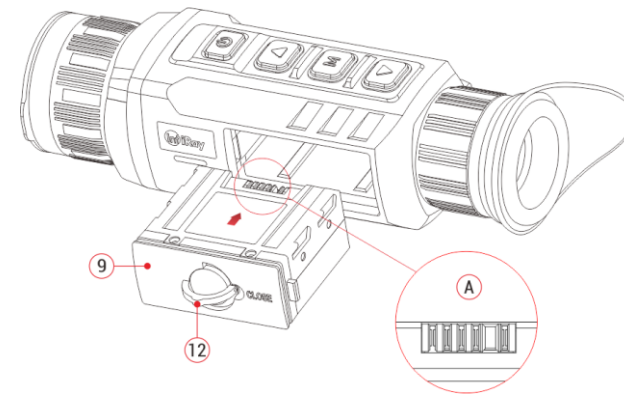

## Precautions for Battery Pack



- **Only use the Battery Charger (13) supplied with the Battery Pack (9).** The use of any other charger may irreparably damage the Battery Pack or the charger and may cause fire.
- **After a long storage time, the battery should be partially charged, not fully charged or discharged.**
- Do not charge the battery immediately after you bring it from the cold environment to the warm environment. Wait 30 to 40 minutes for it to

warm up.

- Do not charge the battery unsupervised.
- Do not use the charger if it is modified or damaged.
- Charge the battery in the environment of 0°C to +45°C. Otherwise, the service life of the battery will be reduced.
- Charging time should not exceed 24 hours.
- Do not expose the Battery Pack to high temperature or a naked flame.
- Do not immerse the Battery Pack in water.
- Do not connect external device with a current consumption that exceed permitted levels.
- The Battery Pack is equipped with a short circuit protection function. However, any situation that may cause short-circuiting should be avoided.
- Please do not disassemble or modify the Battery Pack without professional instructions.
- Do not knock or drop the Battery Pack.
- The battery capacity may decrease when using the battery in negative temperature, that is normal, not a defect.
- Avoid using the Battery Pack at the temperature above the temperature shown in the table, this may decrease the battery back's life.
- Please keep the Battery Pack out of the reach of children.

## 8 External Power Supply

The Zoom series can be powered with an external power supply, such as a Power Bank (5V).

- Connect the external power supply to the Type-C port **(17)** on the bottom of the Zoom series.
- The device will switch to the external power supply and charge the internal Battery Pack at the same time.
- The battery icon will be changed to the charging icon  .
- If the device is connected to an external power source and no Battery Pack is installed, the battery icon will be changed to the USB icon .
- When the external power supply is disconnected, the Zoom series will automatically switch to the Battery Pack without powering off.

## 9 Power On and Image Settings

- Remove the lens cap **(1)**.
- Press and hold the **Power button (5)** to power on the device. Then, the home screen is displayed after several seconds.
- Rotate the eyepiece diopter ring **(10)** until the image becomes clear in the eyepiece. After the adjustment, it no needs to be adjusted for the

same user.

- Rotate the focusing ring **(2)** of the objective lens to focus on the object to be observed.
- To set the image mode, display brightness, image sharpness, image contrast, and so on, refer to the **Shortcut Menu** section in this manual.
- After use, press and hold the **Power button (5)** and a shutdown countdown is displayed. Release the button after the countdown. The thermal camera is turned off.

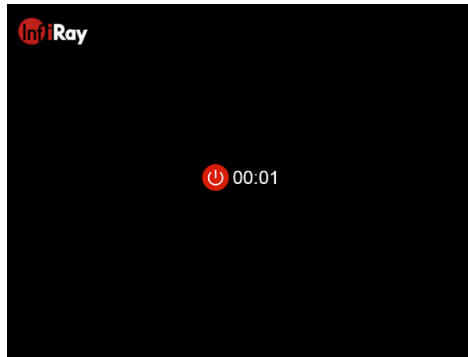

## 10 Calibration

Benefit from the shutterless thermal imaging core, Zoom series capture high-quality images without a mechanical shutter.

In rare cases, once the image is degraded or uneven, it can be improved by calibration. There are two calibration modes:

- On the home screen, briefly press the **button Up (6)** and **down (8)** to perform the calibration without closing the lens cap (the internal shutter covers the sensor).
- Close the lens cap press and hold the **button Up (6)** and **down (8)**. A

text prompt reading “Cover lens during calibration” will appear on the screen. The background calibration will start after 2s.

## 11 Digital Zoom

The Zoom series supports quick digital zoom-in for images, to increase visual magnification.

- On the home screen, briefly press the **Up button (6)** to circularly zoom the image.
- The corresponding magnification is displayed in the status bar.
- The following table lists the visual magnifications corresponding from the 1× to 4×.

Model	Focal Length	Digital Zoom			
		1×	2×	3×	4×
ZH25	13mm	1.1	2.2	3.3	4.4
	25mm	2.2	4.4	6.6	8.8
ZH38	19mm	1.6	3.2	4.8	6.4
	38mm	3.2	6.4	9.6	12.8
ZH50	25mm	2.2	4.4	6.6	8.8
	50mm	4.4	8.8	13.2	17.6

## 12 Photographing and Video Recording

The Zoom series thermal camera is equipped with a built-in 32GB memory storage and supports photographing and video recording. The image and video files will be named after time, so it is recommended to set the system date and time in the Main Menu before using the photo and video functions (refers to **Main Menu - Settings - Date/Time Setting** in this manual), or to synchronize the system date and time in the settings of the InfiRay Outdoor App. For details, refer to the Operating Instructions for the App in our official website ([www.infirayoutdoor.com](http://www.infirayoutdoor.com)).

### Photographing

- On the home screen, press the **Down button (8)** to take a photo. The image freezes for 0.5 sec with a camera icon  flash on the upper left corner. After the image is taken, the icon disappears.
- The images taken are saved in the built-in memory storage.

### Video Recording

- On the home screen, press and hold the **Down button (8)** to start the video recording.

- The recording icon  and recording time prompt are displayed on the upper left corner of the display, and the time is in the format of HH:MM:SS (hour: Minute: Second).

- The red dot on the left of the time prompt will flash continuously when recording.

- During recording, you can also take a photo by pressing the **Down button (8)**.



- Press and hold the **Down button (8)** to stop and save the video. Recording.
- All videos and photos will be saved in the built-in memory storage.
- Zoom series is built-in Microphone function, which will be automatically enabled when starting a video recording, and the microphone icon is displayed in the status bar on the top of the screen.
- When turning off the video recording function, the microphone function is turned off and the icon in the status bar is disappeared automatically.

### Note



- You can enter and work on the menu during video recording.
- The image taken and the recorded video will be respectively saved in the names in the formats of IMG\_yyyyMMddHHmms.jpg and

VID\_yyyyMMddHHmmss.mp4 in the built-in memory card (yyyyMMddHHmmss-year, month, date, hour, minute, and second);

- The maximum duration of a video recording file is 30 minutes. When the duration is more than 30 minutes, the video will be automatically recorded onto a new file.
- Due to the limitation of the storage space, it is recommended that you clean the memory regularly or move the images and videos to other storage medium to release memory space of the device.

## Memory Access

When the device is powered on and connected to a computer, it will be recognized by the computer as a flash memory card. Then, you can access the memory of the device and copy images and videos.

- Connect the device to a computer through the data cable.
- Power on the device.
- Double-click "My Computer" on the desktop - double-click to open the device named "Infiray"  - then double-click to open the device name "Zoom\_Storage"  to access the memory.
- Files named by time will be displayed after you access the memory.





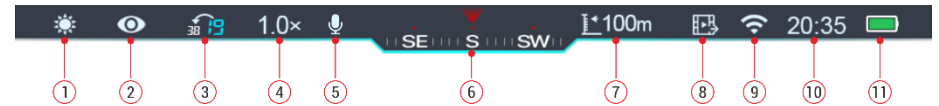

## 13 State Bar



The status bar is on the top of the display to indicate the current operation status of the thermal camera. The display content from the left to the right are as follows:

1. Current image mode (☀️: white-hot; 🌑: black-hot; 🔥: red-hot; 🌈: pseudo-color; 🐦: highlight)
2. Ultraclear mode status: (👁️: the ultra-clear mode is off; 👁️: the ultra-clear mode is on)
3. Current focal length of the objective lens
4. Current magnification (such as 2.0x)
5. Mic (displayed during video recording)
6. Compass (when it is on)
7. Current altitude (when it is on)
8. Video output (when it is on)
9. Wi-Fi status (🚫: Wi-Fi is off; 📶: Wi-Fi is on)
10. Time
11. Battery Pack status

Icon	Color/Status	Battery Status
	Green	more than 40%
	Yellow	20% - 40%
	Red	Less than 20%, need to charge instantly
	Lightning icon inside	External power supply meanwhile charging the Battery Pack
	USB icon	External power supply without Battery Pack in the Zoom

## 14 Shortcut Menu

On the shortcut menu, you can quickly adjust basic configurations of commonly used functions, including the image mode, display brightness, image sharpness, and image contrast.

- In the home screen, press the **M button (7)** to go to the shortcut menu.
- Press the **Up (6) / Down (8)** button to switch the following options.

- **Image mode:** Press the **M button (7)** to change the image mode (white hot, black hot, red hot, pseudo-color, and highlight).
- **Image brightness:** Press the **M**

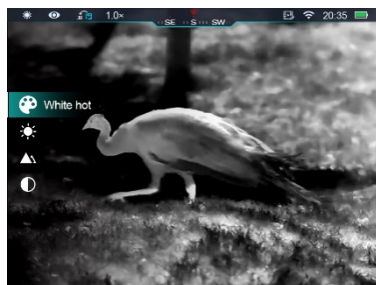

**button (7)** to change the image brightness from level 1 to level 5.

- **Image sharpness:** Press the **M button (7)** to change the image sharpness from level 1 to level 5.
- **Image contrast:** Press the **M button (7)** to change the image contrast from level 1 to level 5.

- Press and hold the **M button (7)** to save the changes and return to the home screen.

**Note:** In the shortcut menu, if there is no operation within 5s, the device will automatically save the changes and return to the home screen.

## 15 Main Menu

- In the home screen, press and hold the **M button (7)** to go to the main menu.
- Press the **Up (6) / Down (8)** button to switch the menu options.
- The function options in the main menu are cyclical: when the arrow > reaches the last option on the first page, it will turn to the first menu option on the second page. When the arrow > is on the first option of the first page, press the **Up (6)** button to switch to the last option of the second page.
- Press the **M button (7)** to modify the parameter settings of the current



menu option or to open the submenu.

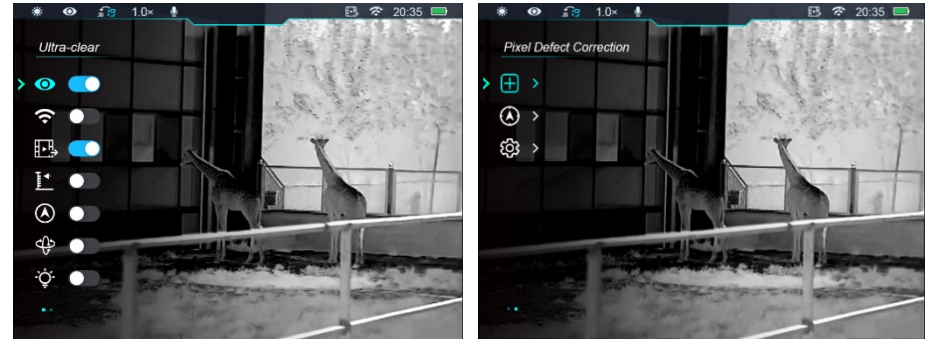

- In the second and third-level submenu, press the **Up (6) / Down (8)** button to choose a parameter or function; press the **M button (7)** to confirm the selection. An icon flashes, indicating the changes are being saved, and then the upper menu or the submenu is displayed;
- In any menu interface, press the **Power button (5)** to return to the upper menu or home screen without saving the changes, and press and hold the **M button (7)** to save the changes and return to the home screen.
- In any menu interface, the device will automatically return to the home screen without saving the changes when there is no operation within 15s.

- During the continuous operation of the thermal camera, when you exit from the main menu, the cursor > remains at the position before exiting. When you restart the thermal camera and go to the main menu for the first time, the cursor stays at the first menu option.





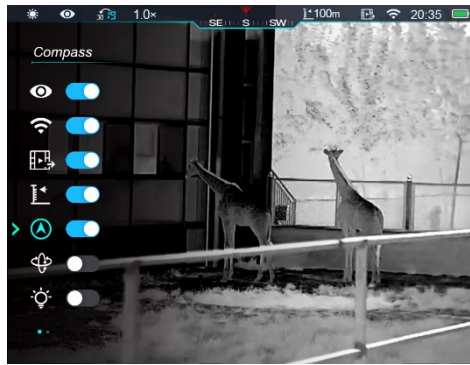

## Main Menu Options and Descriptions

<p style="text-align: center;"><b>Ultra-clear</b></p> 	<p><b>Turn the Ultra-clear mode on/off</b></p> <ul style="list-style-type: none"> <li>● Press and hold down the <b>M (7)</b> button to enter the main menu.</li> <li>● Select the <b>Ultra-clear</b> menu option with the <b>Up (6) / Down (8)</b> button.</li> <li>● Turn the Ultra-clear mode on /off with a short press of <b>M (7)</b> button, during which you will hear a click of shutter calibration.</li> <li>● When the function is turned on/off, the icon in the status bar changes accordingly.</li> <li>● When the Ultra-clear mode is on, the image contrast is enhanced, which is suitable for rainy, foggy and other harsh weather conditions.</li> </ul>
<p style="text-align: center;"><b>Wi-Fi</b></p> 	<p><b>Turn Wi-Fi on/off</b></p> <ul style="list-style-type: none"> <li>● Press and hold down the <b>M (7)</b> button to enter the main menu.</li> </ul>

	<ul style="list-style-type: none"> <li>● Press the <b>Up (6) / Down (8)</b> button to select the <b>Wi-Fi</b> option.</li> <li>● Turn the Wi-Fi on /off with a short press of <b>M (7)</b> button</li> <li>● When the function is turned on/off, the icon in the status bar changes accordingly.</li> </ul>
<p><b>Video Output</b></p> 	<p><b>Turn video output on/off</b></p> <ul style="list-style-type: none"> <li>● Press and hold down the <b>M (7)</b> button to enter the main menu.</li> <li>● Press the <b>Up (6) / Down (8)</b> button to select the <b>Video Output</b> option.</li> <li>● Briefly press the <b>M (7)</b> button to turn video out on/off.</li> <li>● After video output is on, the video output icon is displayed in the status bar on the top.</li> </ul>
<p><b>Altimeter</b></p> 	<p><b>Turn the altimeter on/off</b></p> <ul style="list-style-type: none"> <li>● For accurate measurement, please connect to APP for calibration before using the altimeter.</li> <li>● Press and hold the <b>M (7)</b> button to enter the main menu.</li> <li>● Press the <b>Up (6) / Down (8)</b> button to select the <b>Altimeter</b> option.</li> <li>● Press the <b>M (7)</b> button to turn the altimeter on/off.</li> <li>● After the function is on, the altimeter readings will be displayed in the status bar on the top.</li> </ul>
<p><b>Digital Compass</b></p> 	<p><b>Turn the digital Compass on/off</b></p> <ul style="list-style-type: none"> <li>● Press and hold the <b>M (7)</b> button to enter the main menu.</li> <li>● Press the <b>Up (6) / Down (8)</b> button to select the <b>Digital Compass</b> option.</li> <li>● Press the <b>M (7)</b> button to turn the digital compass on/off.</li> <li>● After the digital compass is turned on, it will be displayed in the middle of the status bar on the top.</li> </ul> 



<p><b>Motion Sensor</b></p> 	<p><b>Turn the motion sensor on/off</b></p> <ul style="list-style-type: none"> <li>● Press and hold the <b>M (7)</b> button to enter the main menu.</li> <li>● Press the <b>Up (6) / Down (8)</b> button to select the <b>Motion Sensor</b> option.</li> <li>● Press the <b>M (7)</b> button to turn the gravity sensor on/off.</li> <li>● After the motion sensor is enabled, its functions will be displayed on both sides of the screen.</li> <li>● The curved ruler on the left represents the tilt angle and the vertical ruler on the right represents the pitch angle.</li> </ul>	
<p><b>Status Light</b></p> 	<p><b>Turn the Status light on/off</b></p> <ul style="list-style-type: none"> <li>● Press and hold down the <b>M (7)</b> button to enter the main menu.</li> <li>● Press the <b>Up (6) / Down (8)</b> button to select the <b>Status Light</b> option.</li> <li>● Press the <b>M (7)</b> button to turn the status light function on/off.</li> <li>● When the status light is on, the status light will show steady green during normal operation, and the status light will blink during standby.</li> </ul>	
<p><b>Pixels Defect Correction</b></p> 	<p><b>Correcting the defective pixels</b></p> <p>When using the thermal camera, you may see defective pixels, such as visible light spots or dark spots with stable brightness. To address this problem, use the defective pixel correction function to remove the defective pixels.</p> <ul style="list-style-type: none"> <li>● Press and hold down the <b>M (7)</b> button to enter the main menu.</li> <li>● Press the <b>Up (6) / Down (8)</b> button to select the <b>Pixels Defect Correction</b> option.</li> <li>● Press the <b>M (7)</b> button to enter the defective pixel correction interface. The PIP function is automatically turned on, and displayed on the lower-left corner by default.</li> </ul>	

- The right side of the PIP window shows the cursor moving direction (X-axis, Y-axis), and number of defective pixel correction.
- Press the **M (7)** button to change the moving direction, and press the **Up (6) / Down (8)** button to move the cursor.
- You can repeat the preceding steps to change the cursor location until it reaches the position of the defective pixel.
- Press the **Power (5)** button to add a defective pixel. In the PIP window, the word "**Add**" is displayed, and the defective pixel is added.
- At the same position, you can revoke the defective pixel correction by pressing the **Power (5)** button again. **Del** is displayed in PIP window.
- Each time you add or delete a defective pixel, the number of defective pixels changes accordingly.
- When the cursor moves near PIP, PIP and the content on the right will move to the upper left corner automatically.
- After the correction, press and hold the **M (7)** button until a prompt is displayed to confirm whether to save the correction. You can choose **Yes** to save the correction and exit or choose **No** to cancel the correction and exit.



### Compass

### Calibration



#### Calibrating the digital magnetic compass

- Press and hold down the **M (7)** button to enter the main menu.
- Press the **Up (6) / Down (8)** button to select the **Compass Calibration** option.
- Press the **M (7)** button to enter the compass calibration interface. The calibration prompt will be displayed on the screen.

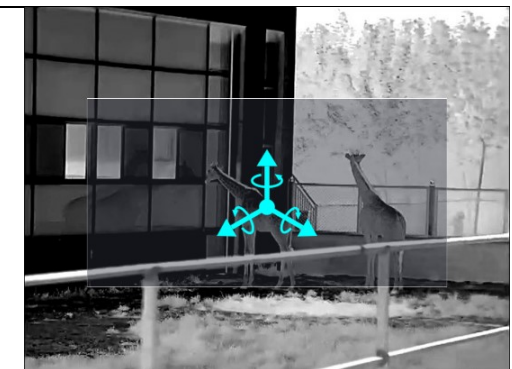

- Rotate the thermal camera along the three axes indicated by the icon, with each axis rotating at least 360°.
- After 15s, the calibration is finished and exit to the main menu automatically.

### Setting the general settings

- Press and hold down the **M (7)** button to enter the main menu.
- Press the **Up (6) / Down (8)** button to select the **General Settings** option.
- Briefly press the **M (7)** button to enter the submenu.
- This menu item allows you to configure the following settings.

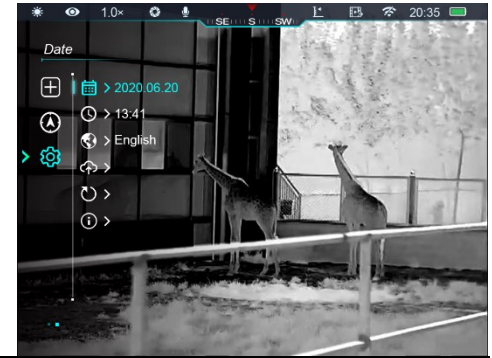

### General Settings



#### Date



#### Setting the system date

- In the **General Settings** submenu, select the **Date** menu option with the **Up (6) / Down (8)** button.
- The date is in the format of **YY/MM/DD**.
- Briefly press the **M (7)** button to active the **Date** submenu. Two triangle icons will appear above and below the value.
- Switch among the year, month, and day with a short press of the **M (7)** button.
- Set the correct year, month, and day with a short press of the **Up (6) / Down (8)** button.
- Press and hold down the **M (7)** button to save and exit.

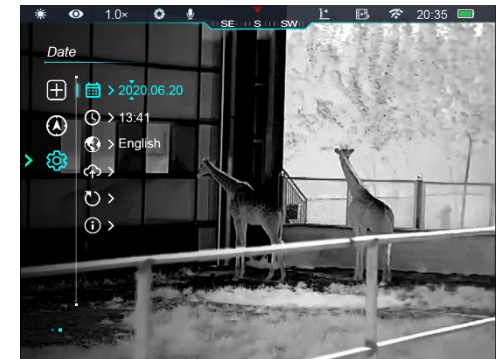







#### Time

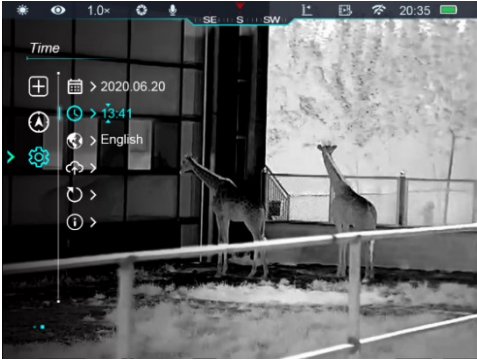

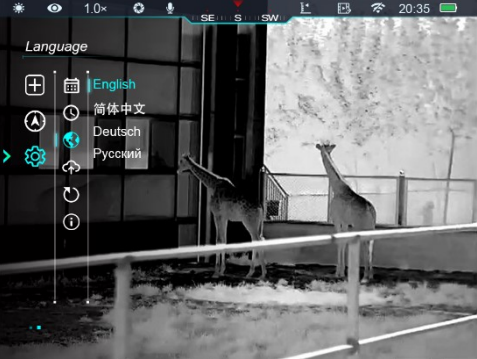

#### Setting the system time

- In the **General Settings** submenu, select the **Time** menu option with the **Up (6) / Down (8)** button.
- The time format is displayed as **HH:MM** in 24-hours format.

		<ul style="list-style-type: none"> <li>● Briefly press the <b>M (7)</b> button to active the <b>Date</b> submenu. Two triangle icons will appear above and below the value.</li> <li>● Select the correct value for the hour and minute with a short press of the <b>Up (6) / Down (8)</b> button.</li> <li>● Switch between hour and minute with a short press of the <b>M (7)</b> button.</li> <li>● Press and hold down the <b>M (7)</b> button to save and exit. And the time in the status bar changes accordingly.</li> </ul> 
	<p><b>Language</b></p> 	<p><b>Setting the system language</b></p> <ul style="list-style-type: none"> <li>● In the <b>General Settings</b> submenu, select the <b>Language</b> menu option with the <b>Up (6) / Down (8)</b> button.</li> <li>● Enter the <b>Language</b> submenu with a short press of the <b>M (7)</b> button.</li> <li>● Select the desired language with a short press of the <b>Up (6) / Down (8)</b> button.</li> <li>● Press the <b>M (7)</b> button briefly to confirm the selection. At the same time, it will save setting and exit to the general settings submenu automatically.</li> </ul> 
	<p><b>Firmware Update</b></p> 	<p><b>Update firmware for Zoom series</b></p> <p>Before updating, you need to copy the downloaded firmware program to the memory storage build-in the Zoom.</p> <ul style="list-style-type: none"> <li>● Connect Zoom series to the computer and power on Zoom.</li> </ul>

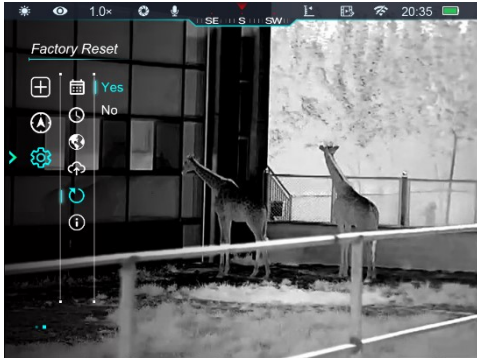
		<ul style="list-style-type: none"> <li>● Open the ZOOM_Storage folder and create a new folder names "update" in the computer.</li> <li>● Copy the downloaded firmware program (.zip) to the update folder in the ZOOM_Storage.</li> <li>● Then, in the <b>General Settings</b> submenu, select the <b>Firmware Update</b> menu option with the <b>Up (6) / Down (8)</b> button.</li> <li>● Open the <b>Firmware Update</b> submenu with a short press of the <b>M (7)</b> button.</li> <li>● Short press the <b>Up (6) / Down (8)</b> to select Yes or No. Select <b>Yes</b> to confirm update and select <b>No</b> to cancel update.</li> <li>● Confirm your selection with a short press of the <b>M (5)</b> button.</li> <li>● If Yes is selected, the thermal camera will update and restart automatically.</li> </ul> 
	<p><b>Factory Reset</b></p> 	<p><b>Restoring factory default settings</b></p> <ul style="list-style-type: none"> <li>● In the <b>General Settings</b> submenu, select the <b>Factory Reset</b> menu option with the <b>Up (6) / Down (8)</b> button.</li> <li>● Enter the <b>Factory Reset</b> submenu with a short press of the <b>M (7)</b> button.</li> <li>● Press the <b>Up (6) / Down (8)</b> button to select Yes or No. Yes means to restore factory settings and No means canceling the operation.</li> <li>● Confirm your selection with a short press of the <b>M (5)</b> button.</li> <li>● If Yes is selected, the thermal camera will reboot automatically.</li> <li>● If No is selected, the operation is canceled and the screen returns to the upper menu.</li> </ul> <p>After the Factory Reset is selected, the following functions will be restored to default settings:</p>

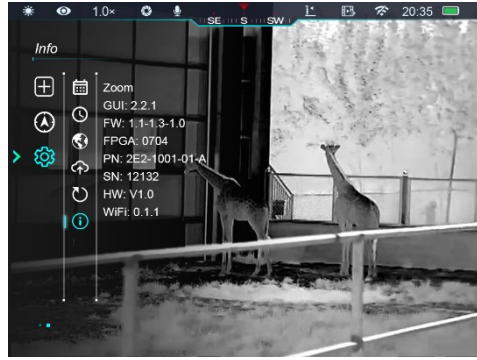
		<ul style="list-style-type: none"> <li>- <b>Image mode:</b> White hot</li> <li>- <b>Ultra-clear mode:</b> Off</li> <li>- <b>Digital zoom:</b> 1× magnification</li> <li>- <b>Compass:</b> Off</li> <li>- <b>Wi-Fi:</b> Off</li> <li>- <b>Motion sensor:</b> Off</li> </ul>	
	<p><b>Info</b></p> 	<p><b>Showing the system information</b></p> <ul style="list-style-type: none"> <li>● In the <b>General Settings</b> submenu, select the <b>Info</b> menu option with the <b>Up (6) / Down (8)</b> button.</li> <li>● The relevant information of device will be shown by a short press of the <b>M (7)</b> button.</li> <li>● This item allows the user to view the following information of the current thermal camera: product model, GUI vision, FPGA, PN, SN, hardware version number, etc.</li> <li>● Press and hold the <b>M (7)</b> button to return to the General Settings submenu.</li> </ul>	

## 16 PIP Function

Picture-in-Picture (PIP) provides a floating window independent of the full screen. This window shows part of the image which is enlarged to 2× in a

certain area centered on the reticle of the main image.

- On the home screen, press and hold the **Up button (6)** to turn the PIP function on/off.



- When you press the **Up button (6)** to enlarge the main image, the image in the PIP window will also be enlarged by 2 times accordingly. For example, if the main image is enlarged by 1×, 2×, 3×, or 4×, the image in the PIP window will be enlarged by 2×, 4×, 6×, or 8× respectively.

## 17 Stadiametric Rangefinder

- In the home screen, press and hold the **Up (6) + M (7)** buttons at the same time to turn the stadiametric ranging function on/off.
- After this function is enabled, two horizontal lines used for measuring will appear on the screen, and icons of three pre-configured objects and measured values will be displayed on the right side.
- Dimensions of three pre-defined objects are:

- Deer: 1.7 m high
- Wild boar: 0.9 m high
- Hare: 0.2 m high

- Adjust the target to the center of the screen and align the horizontal lines with the target through long or short pressing the **Up (6) / Down (8)** button.



- The icon on the left shows the approximate distance of the corresponding target.
- Long press the **M (7)** button to exit to the stadiametric ranging function.

## 18 Hotspot Tracking

Zoom series provides hotspot tracking function, which allows you to track the hottest object in the image.

- In the home screen, press and hold the **M (7) +Down (8)** buttons at the same time to turn the hotspot tracking function on/off.
- After this function is enabled, a blue box will appear in the image and track the hottest object automatically.



## 19 Wi-Fi Function

The Zoom series has a built-in Wi-Fi module. The device can connect to an external apparatus (computer or mobile phone) via Wi-Fi.

- In the main menu, enable the Wi-Fi on the device (for details of

specific operations, refer to the operations of main menu functions).

- After the Wi-Fi is enabled, search for the Wi-Fi named ZOOM\_XXXXXX on the external device, among which XXXXXX is the serial number of the device.
- Select the Wi-Fi, enter the password and connect. The initial password is 12345678.
- After the Wi-Fi connection is established, you can control the device via the mobile app.

## Setting Wi-Fi name and password

The Zoom series allows you to change the name and password of the Wi-Fi in the app.

- In the app, find the settings icon , and touch it to enter the settings.
- In the text box, enter and submit the new Wi-Fi name (SSID) and password.
- After submitting the change, reset the device to activate the settings.

**Caution!** After the device is restored to the factory settings, the name and password of the Wi-Fi will also be

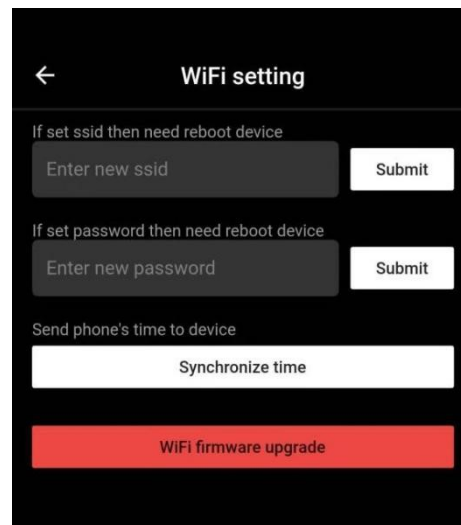

restored to the default factory settings.

## 20 Update and InfiRay Outdoor

The Zoom series thermal camera supports control with **InfiRay Outdoor** App, which allows you to transmit images in real time, operate the device, and update the program by connecting a smartphone or laptop via Wi-Fi. The user manual of **InfiRay Outdoor** can be downloaded at our official website ([www.infirayoutdoor.com](http://www.infirayoutdoor.com)).

### About InfiRay Outdoor

- You can download and install the **InfiRay Outdoor** App In the official website ([www.infirayoutdoor.com](http://www.infirayoutdoor.com)) or an app store. Alternatively, you can scan the QR code below to download it for free.



- When installation completed, open InfiRay Outdoor application.



- If your device has been connected to a mobile device, please switch on the mobile data in mobile device. After connection, an update prompt will be displayed automatically in the APP. Click **Now** to download the latest version immediately or click **Later** to update later.
- **InfiRay Outdoor** can store the last connected device automatically. Therefore, once you have connected with **InfiRay Outdoor** before, it will automatically detect the update even when the scope is not connected to a phone or laptop.
- If an update is available and the mobile device accesses the internet, you can download the update first. Then when the device is connected with the mobile device, it will be updated automatically.
- After the update is installed, the device will restart automatically.

## 21 Technical Inspection

Perform a technical inspection to check the following items each time before you use the device:

- Exterior of the device (no crack on the enclosure).
- Lens and eyepiece (no crack, oil, stain, or other sediments)
- Status of the rechargeable battery (fully charged in advance) and electrical contact (no salinization or oxidation).

## 22 Maintenance

The maintenance should be carried out at least twice a year and includes the following steps:

- Wipe the surface of metal and plastic parts to clear off dust and dirt with a cotton cloth. Silicone grease may be used for cleaning process.
- Clean the electric contacts and battery slots on the device using a non-greasy organic solvent.
- Check the glass surface of the eyepiece and lens. If necessary, clear off the dust and sand on the lens (it is perfect to use a non-contact method). Use a specialized wiping tool and solvent to clean the optical surfaces.

## 23 Troubleshooting

The following table lists all problems that are likely to occur during device operation. Check and address problems by referring to this table. If faults not included in this table occur or you cannot fix the fault, return the device to the vendor or supplier for troubleshooting.

Faults	Possible Causes	Solutions
The thermal camera cannot start.	The battery is out of charge	Charge the battery
The device cannot be powered by an external power supply	The USB cable is damaged	Replace the USB cable
	The external power supply is insufficient	If necessary, check the external power supply
Images are too dark	The display is not bright enough	Adjust the display brightness
The image quality is poor or the detection range shortens	These problems are likely to occur when you use the device in harsh weather (such as snow, rain, and fog).	
The device cannot connect to a smartphone or computer	The Wi-Fi password is incorrect	Enter the correct password
	There are too many Wi-Fi networks in the range of the device, which may cause interference	To enable stable network access, you are advised to move the device to an area with a limited number of Wi-Fi networks, or an area without Wi-Fi coverage
Wi-Fi signals are lost or interrupted.	The device is beyond Wi-Fi coverage. There is blocking (such as concrete walls) between the device and the receiver.	Move the device to a place where you can receive Wi-Fi signals.
When the device is used at a low temperature, the imaging quality is poorer than that at normal temperature.	At temperatures above 0°C, the temperature rise varies with the observed objects (environment and background) due to different heat conductivity coefficients. As a result, high-temperature contrast occurs and the image quality is better. At low temperatures, the observed targets (background) usually cool down to a similar temperature because of reduced temperature contrast. Therefore, the image quality (details in particular) is poor, which is a characteristic of thermal imaging devices.	

## 24 Legal and Regulatory Information

Wireless transmitter module frequency range:

**WLAN: 2.412-2.472GHz (for EU)**

Wireless transmitter module power<20dBm (only for EU)



IRay Technology Co., Ltd. thus declares that the ZOOM series thermal imaging monocular complies with the directives 2014/53/EU and 2011/65/EU. The full text of the EU declaration of conformity as well



as additional information are available at: [www.infirayoutdoor.com](http://www.infirayoutdoor.com).



This device may be operated in all member states of the EU.

### FCC Statement

**FCC-ID: 2AYGT-ZOOM**

#### Labeling requirements

This device complies with part 15 of the FCC Rules. Operation is subject to the following two conditions: (1) This device may not cause harmful interference, and (2) this device must accept any interference received,

including interference that may cause undesired operation.

#### Information to the user

Any Changes or modifications not expressly approved by the party responsible for compliance could void the user's authority to operate the equipment.

**Note:** The manufacturer is not responsible for any radio or TV interference caused by unauthorized modifications to this equipment. Such modifications could void the user's authority to operate the equipment.

**Note:** This equipment has been tested and found to comply with the limits for a Class B digital device, pursuant to part 15 of the FCC Rules. These limits are designed to provide reasonable protection against harmful interference in a residential installation. This equipment generates uses and can radiate radio frequency energy and, if not installed and used in accordance with the instructions, may cause harmful interference to radio communications. However, there is no guarantee that interference will not occur in a particular installation. If this equipment does cause harmful interference to radio or television reception, which can be determined by turning the equipment off and on, the user is encouraged to try to correct the interference by one or more of the following measures:

- Reorient or relocate the receiving antenna.
- Increase the separation between the equipment and receiver.

- Connect the equipment into an outlet on a circuit different from that to which the receiver is connected.
- Consult the dealer or an experienced radio/TV technician for help.

This equipment complies with FCC RF radiation exposure limits set forth for an uncontrolled environment.

### **Body-worn Operation**

This device was tested for typical body-support operations. To comply with RF exposure requirements, a minimum separation distance of 0.5cm must be maintained between the user's body and the handset, including the antenna. Third-party belt-clips, holsters, and similar accessories used by this device should not contain any metallic components. Body accessories that do not meet these requirements may not comply with RF exposure requirements and should be avoided. Use only the supplied or an approved antenna.