

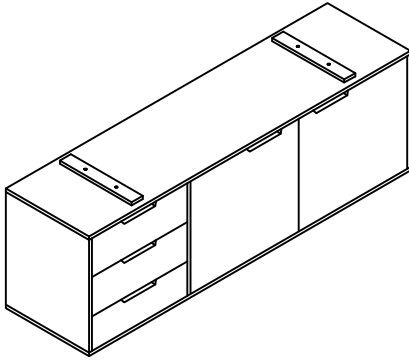

W A Z O

ASSEMBLY INSTRUCTIONS

AX1



BX2

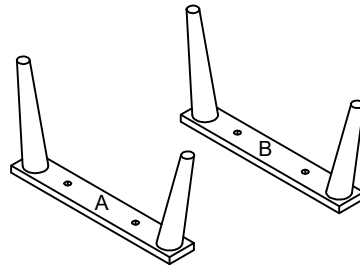

H1X4



H2X4



T1X1



- Note: 1. Please do not tight any bolt unless all bolts are fixed at their respective places.
2. After fixing the bolts tighten them simultaneously.

1

