

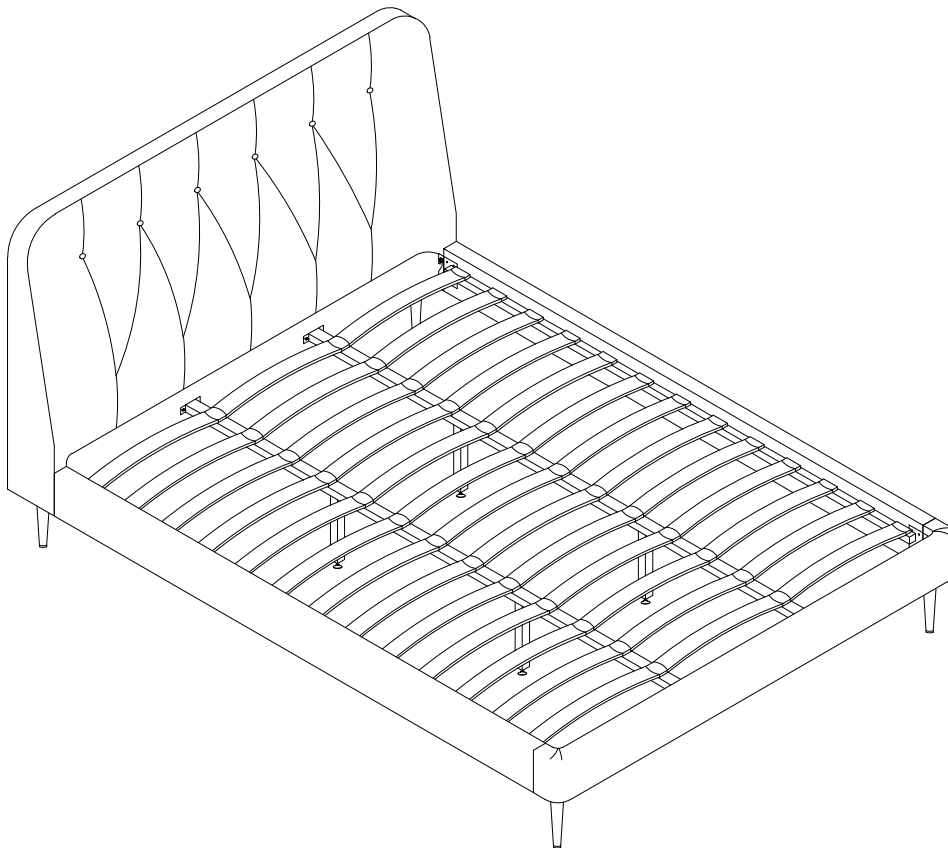

Clara Fabric Bed B1026K





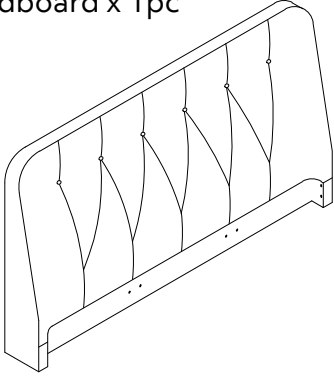
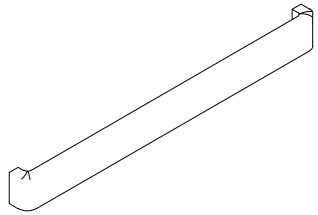
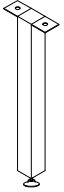
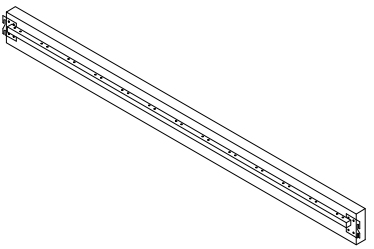
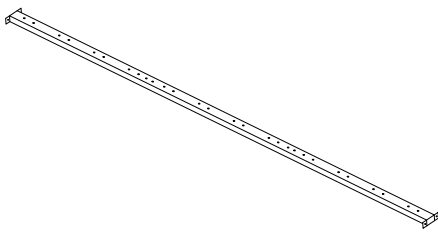
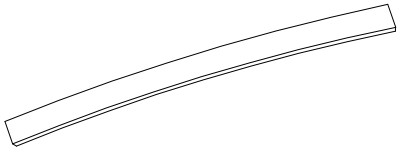
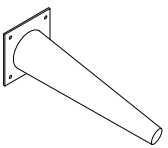

IMPORTANT NOTE

1. PLEASE CHECK THAT ALL PARTS ARE PRESENT BEFORE YOU START THE ASSEMBLY OF YOUR FURNITURE.
2. FOR THE PROTECTION OF YOUR FURNITURE, PLACE ALL PARTS ON A CLEAN AND SMOOTH SURFACE TO PREVENT ANY DAMAGE.
3. DO NOT USE POWER TOOLS TO ASSEMBLE THE BED.
4. PLEASE PERIODICALLY CHECK ALL FITTINGS AND RE-TIGHTEN AS NECESSARY.
5. DO NOT USE THE BED UNLESS ALL BOLTS AND SCREWS ARE FIRMLY SECURED.

PART LIST

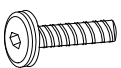
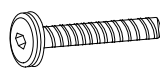
<p>(1) Headboard x 1pc</p> 	<p>(2) Footboard x 1pc</p> 	<p>(3) Support Leg x 4pcs</p> 
<p>(4) Side Rail x 2pcs</p> 	<p>(5) Centre Support Bar x 2pcs</p> 	<p>(6) Slat x 39pcs</p> 
<p>(7) Leg x 4pcs</p> 	<p>(8) Double Plastic Cap x 26pcs</p> 	<p>(9) Single Plastic Cap x 26pcs</p> 

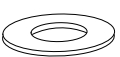
HARDWARE LIST

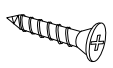
<p>(A) Bolt M8 x 25mm x 16pcs</p> 	<p>(B) Bolt M8 x 40mm x 8pcs</p> 	<p>(C) Nut M8 x 13mm x 8pcs</p> 	<p>(D) Spring Washer x 8pcs</p> 
<p>(E) Flat Washer x 24pcs</p> 	<p>(F) Allen Key M5 x 1pc</p> 	<p>(G) Spanner x 1pc</p> 	<p>(H) Screw M4 x 35mm x 16pcs</p> 

STEP 1

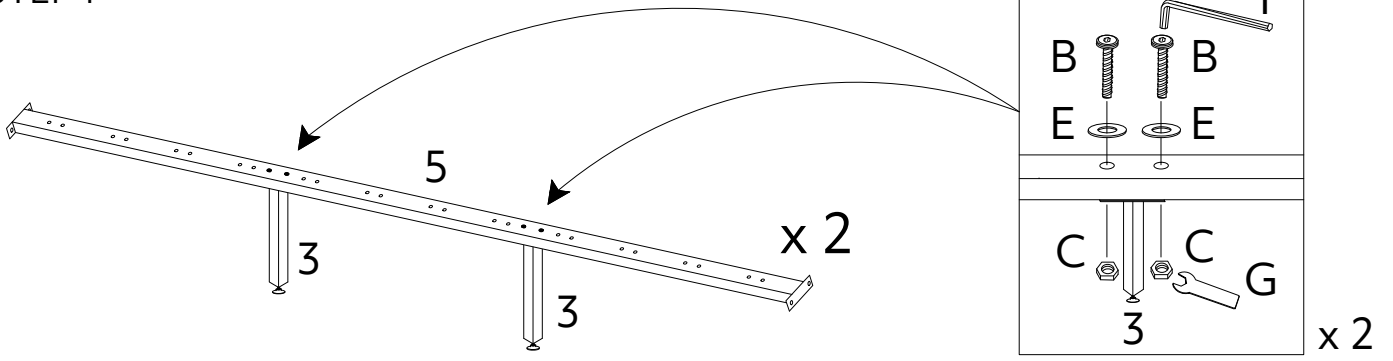

STEP 2

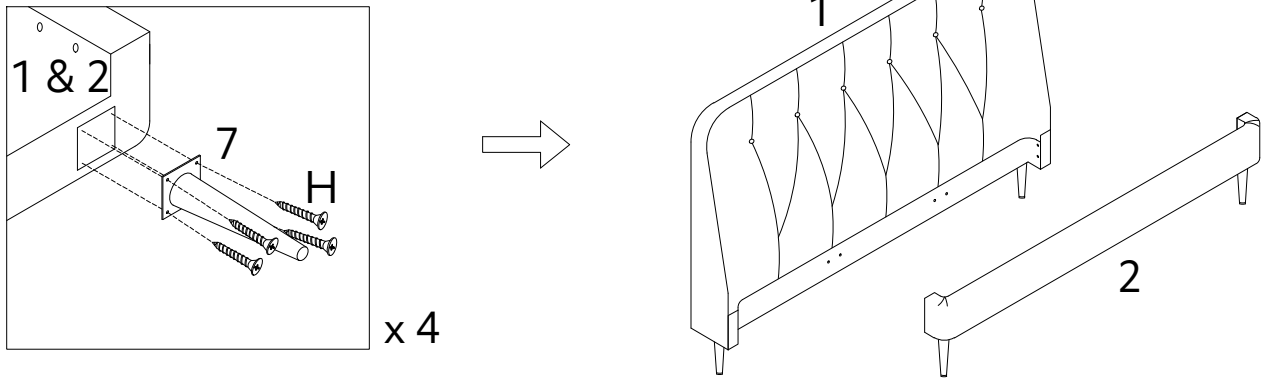

STEP 3

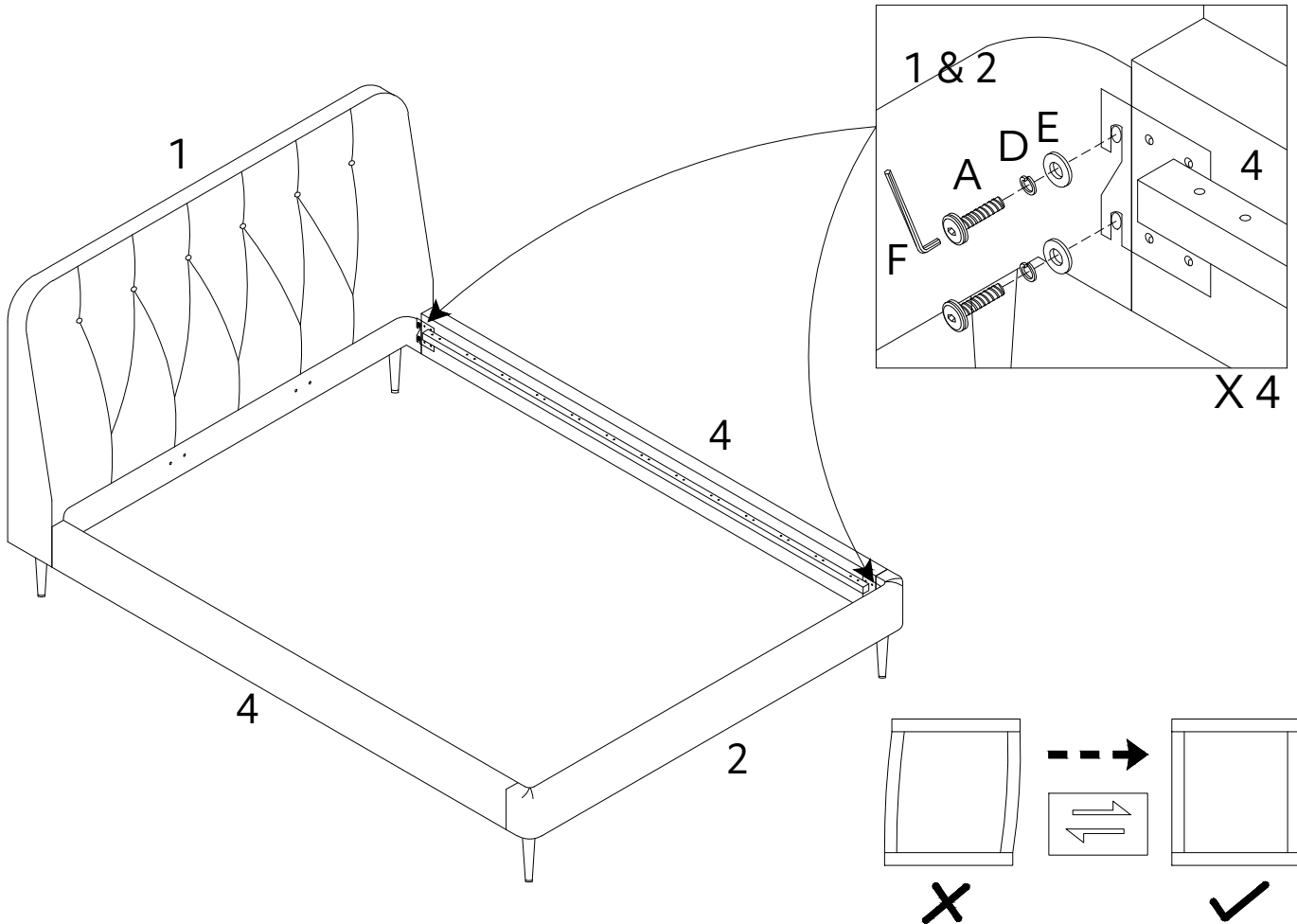

STEP 4

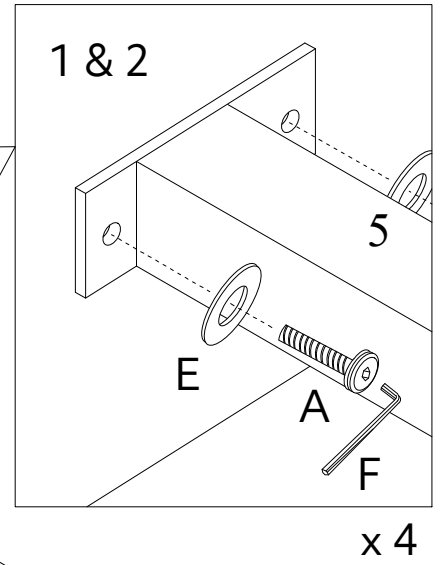
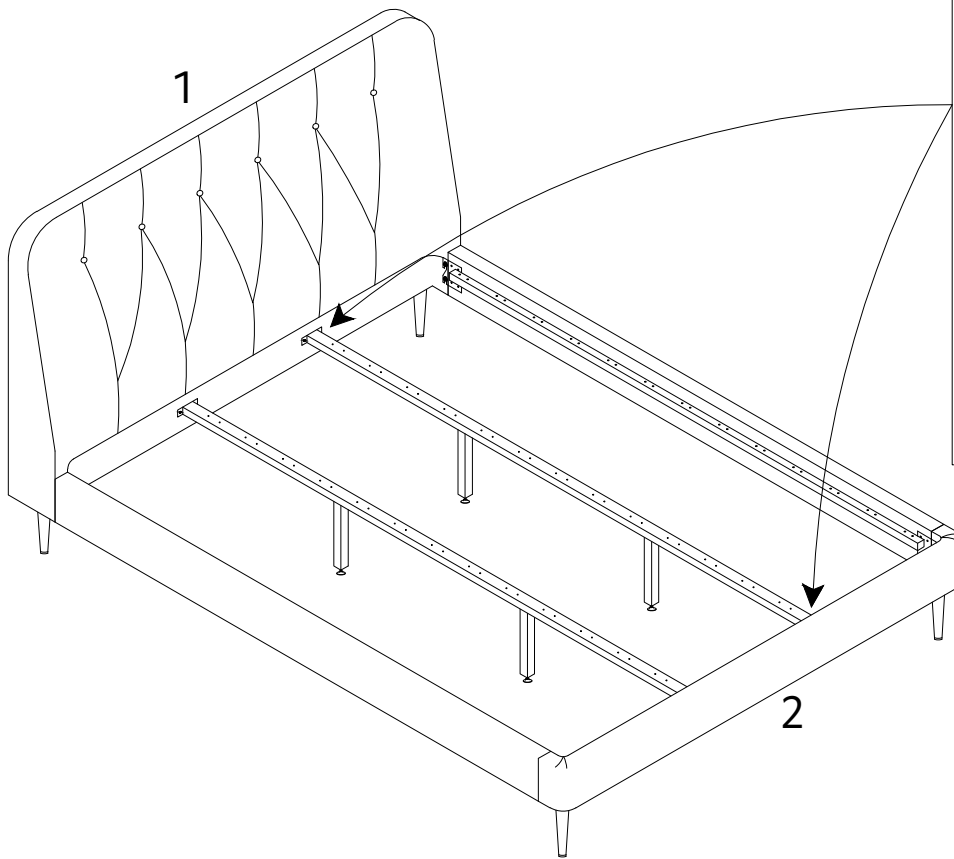

STEP 5

