

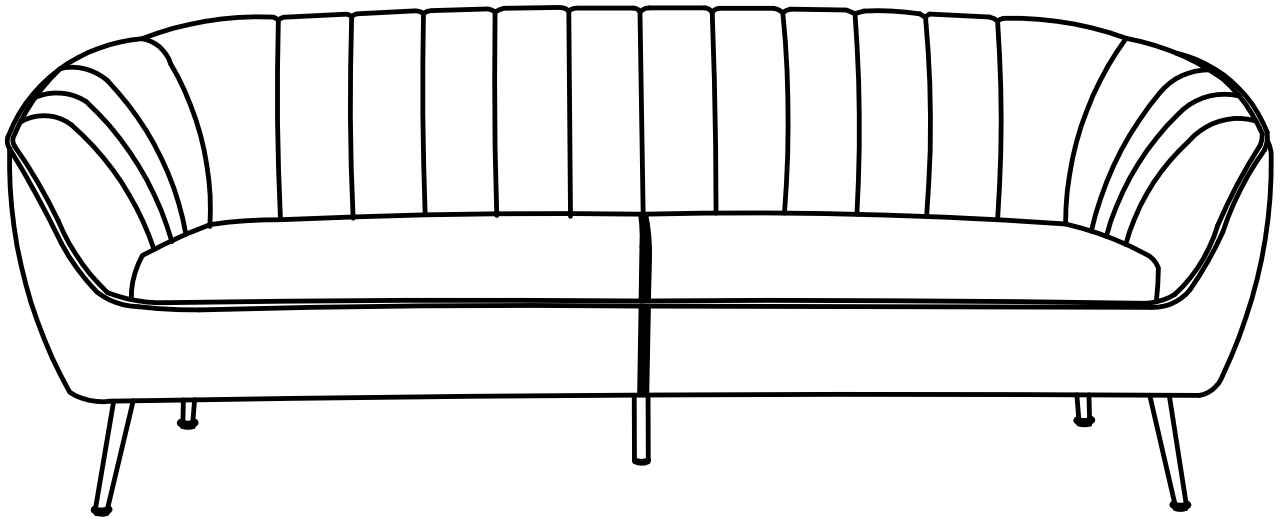

W A Z O

ASSEMBLY INSTRUCTIONS

VERSION1.0



**AUDREY**

Fabric Sofa

### ASSEMBLY INSTRUCTIONS

Read these instructions carefully and keep for future reference. Ensure that you have all the pieces before starting assembly by referring to the parts inventory. When starting assembly, place all pieces on a soft, clean, and flat surface like a carpet to prevent scratches or damage.

If you are having difficulty, our VIP Team is always here for you. Call us at **1-800-684-6014** during business hours or email us at **service@wazofurniture.com**.

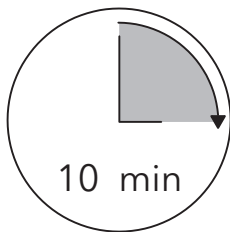

TIME

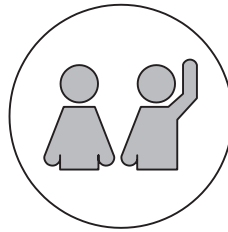

# OF PEOPLE

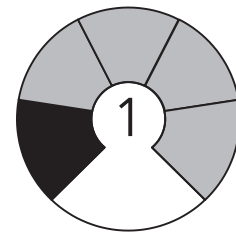

DIFFICULTY

### PARTS INVENTORY

ID	DESCRIPTION	QTY
<b>A</b>	SOFA BODY	1
<b>B</b>	LEGS	4
<b>C</b>	SUPPORT LEG	1

### IMPORTANT NOTES

1. Please check that all parts are present before starting assembly.
2. For the protection of your furniture and to ensure it is not damaged in the assembly process, place all parts on a clean, smooth surface.
3. In order to align all screws properly, tighten all screws halfway first until product frame is assembled and then tighten fully when all screws are aligned.
4. Do not use power tools for assembly.
5. Please periodically check all fittings and re-tighten as necessary.

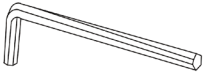

#### HARDWARE/TOOLSVENTORY

ID	DESCRIPTION	QTY
1	M8x25mm BOLT 	16
2	M5 ALLEN KEY 	1



**1**

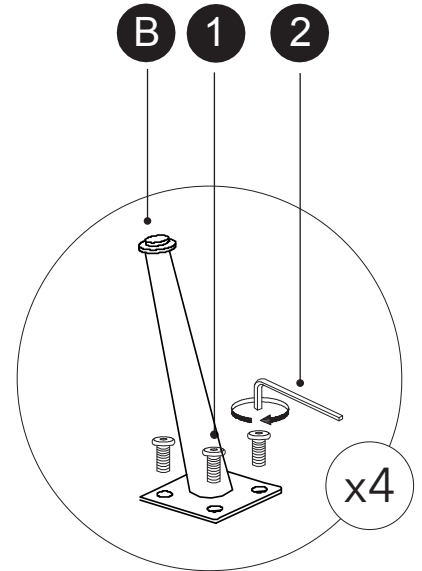
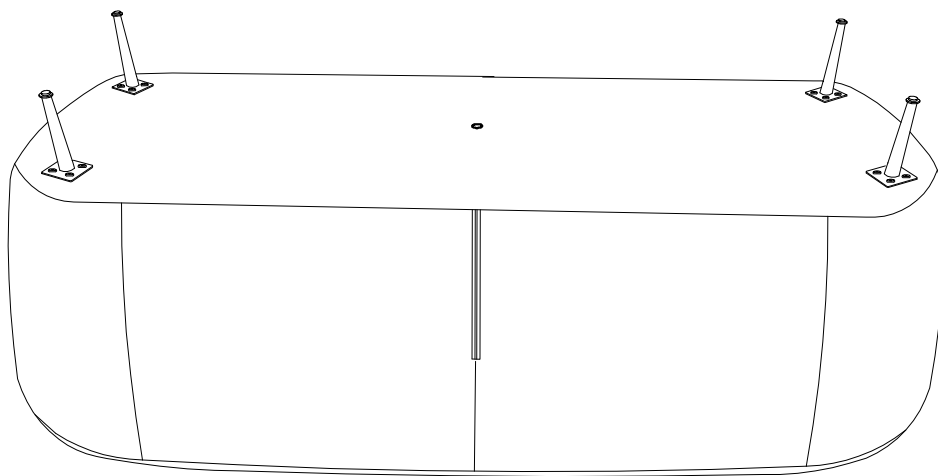

**2**

