

BVF 701

Programmable room thermostat



CONTENTS

1. Scope of application	3
2. Technical data (dimensions, switching current, connection)	3
3. Installation	4
4. Electrical connection	6
5. Display	7
6. Fix modes of operation	8
7. Programming	9
8. Factory settings menu points	10
9. Troubleshooting	13

1. SCOPE OF APPLICATION

The BVF 701 thermostat is a device suitable for controlling electrical heating systems (underfloor heating, wall or ceiling heating, infrapanel, electric radiator). The BVF thermostat is not directly suitable for controlling other systems (such as gas boilers, heat pump, air conditioner, etc.); if you need information about any of these systems, please, contact your dealer. The thermostat should always be connected and installed by a qualified electrical expert. Inappropriate connection of the device may cause an irreversible damage to the thermostat and the controlled equipment and make the guarantee null and void.

2. TECHNICAL DATA (dimensions, switching current, connection)

Supply voltage:	230V AC, 50/60 Hz
Relay loadability:	3600W/16A (recommended: max. 3200W/14A)
Standby power consumption:	0,5W
Display:	black background with white LCD lighting
External sensor:	NTC 10kΩ @ 25°C
Shock protection class:	IP 30
Device housing:	ABS UL94-5 standard fire resistance grade
Measuring range:	5°C–80°C, in 0,5°C steps
Setting accuracy:	± 0,5°C
Programming options:	Weekly 5/1/1; daily 4 cycle times
Device dimensions:	86 mm × 86 mm × 15 mm
Relay installation dimensions:	Ø 65 mm, minimum 55 mm depth

For using the smart thermostat function a more detailed information is provided in the Heato Box Manual.

DIMENSIONS

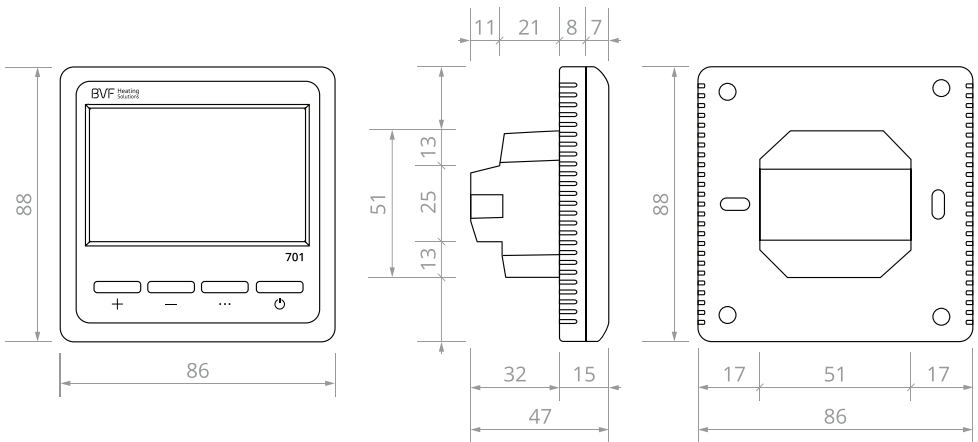

3. INSTALLATION

Before installing the thermostat check if the necessary preparations have been made. You can find the relevant details in the instructions manual of the heating system to be used. The BVF 701 thermostat can be mounted in a recessed mounting box or on a surface mount frame. The dimensions of the recessed mounting box can be seen in the figure below:

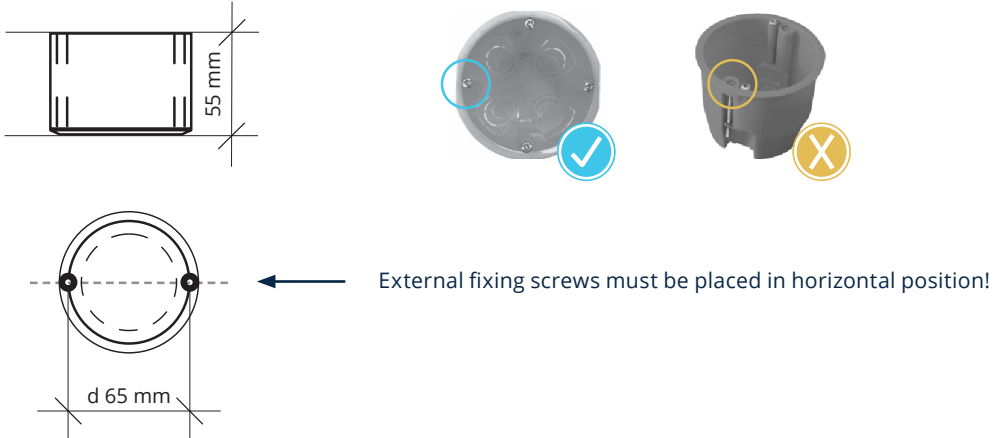

The mounting box should always be of the screw type and be prepared for use with horizontally positioned mounting bolts. The thermostat should be installed in the following manner:

1. Make the relevant electrical circuit dead. Leave the performance of the electrical job to an expert.
2. Remove the front panel of the thermostat: when looking at the thermostat from the front, there is a rectangular-shaped recess at the bottom of the device on its two sides; insert and carefully press a thin screwdriver or phase indicator into this recess and you can now lift off the front panel. Take care not to break the plastic fixing lugs. In cold weather (below +5°C) plastic becomes brittle and the risk of breaking increases. If possible, install the the heating system at a temperature above +5°C.
3. The front and rear panels of the thermostat are connected by a ribbon cable, which should be unplugged from the front cover's plastic socket carefully.
4. Carry out the electrical connection of the rear panel. (Item 4)
5. The back cover must be installed using the screws provided with the mounting box or the thermostat box. Make sure during the mounting of back cover, that the mounted screen on the front cover is readable (it is in „upside up” position). And also, during the back cover installation, pay attention that the wiring does not slip out of the thermostat.
6. Reconnect the thermostat's front cover; slide back along the ribbon cable into the appropriate connector of front panel. Align the ribbon cable with the slot above the connection point on the back panel so that the relay (black rectangle) does not push the cable after the front panel is mounted.
7. Snap the front cover on the backside of thermostat: first, attach the upper side of display to the two upper tab, then snap the two lower locking tab to its place. **CAUTION!** Make sure to not harm the black temperature sensor placed on the bottom center!
8. After turning the thermostat circuit on the circuit is live again and the device can be switched on.

MOUNTING

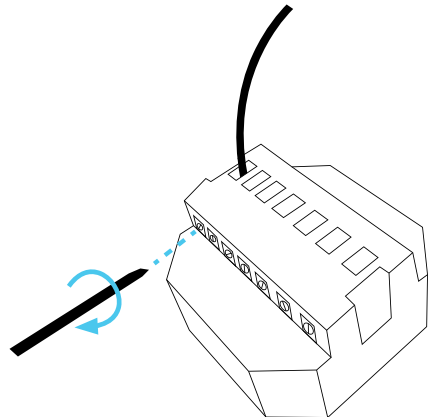
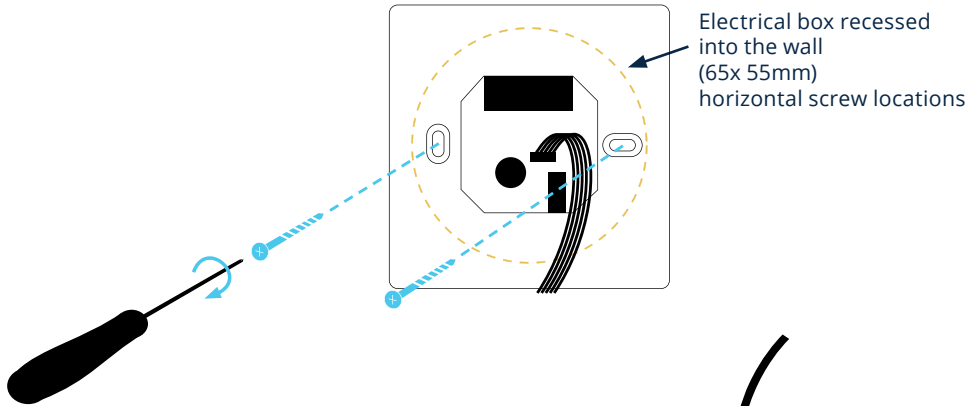
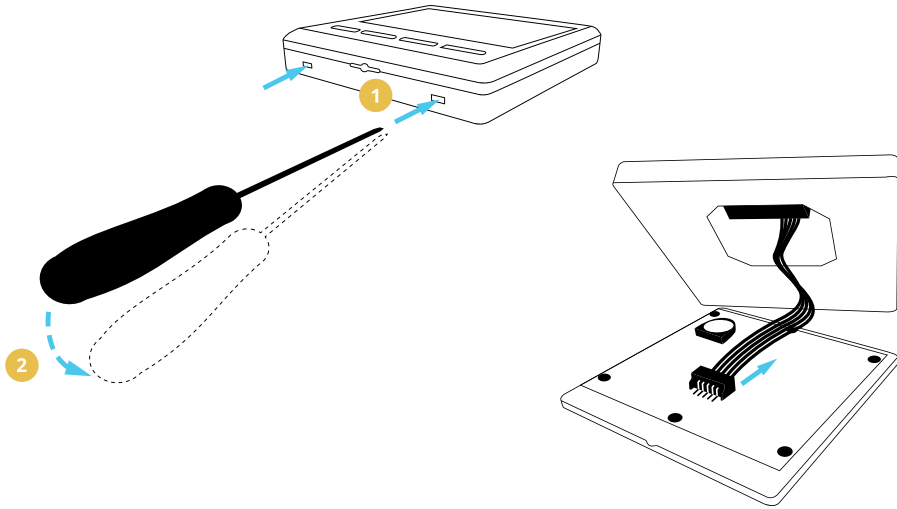

4. ELECTRICAL CONNECTION

The connection of the thermostat should in every case be left to an electrician or a certified heating engineer. The connection should always be performed in accordance with the following. The connection may only be made when the power supply is turned off, therefore make the relevant circuit dead before doing any work in it and check the lack of voltage using a phase indicator/voltage tester or a multimeter. When connecting the system in a live circuit, an electric shock may occur! This description does not contain the general electrical installation specifications (concerning wire stripping, putting the wire ends in sleeves, etc.). The electrical connections must always be made in accordance with the relevant shock protection and electrical installation specifications.

1. Phase supply. Connect the AC 230V (50 Hz) phase wire of the mains power supply here. Attention! The cross-section of the feed wire should be dimensioned with the help of an electrical expert based on the maximum load of the calculated heating output.
2. Neutral connection. Connect the neutral conductor of the mains supply here. (AC 230V dimensioned cross-section)
3. Neutral output. Connect the neutral (blue) wire of the electrical resistance based heating element here.
4. Phase output. Connect the phase (brown) conductor of the electrical resistance based heating element here. Attention! The heating output should not exceed the switching limit value of the thermostat (16 A, recommended max. 14 A).
5. Earthing. Connect the conductor ensuring the shielding of the heating element here and also here should be connected the conductor providing the protective earthing of the mains supply. The thermostat has a double insulation, it is not necessary to earth it. Connection point No.5 functions as a terminal ensuring the linking of the heating element and the mains protective earth. The earthing/shielding wire of the mains protective earth and the heating element can also be connected outside the thermostat.
6. Sensor connection. Connect here one of the wires of the external, i.e. surface sensor that can be used in the case of surface heating. The thermostat's sensor is not „phase-sensitive“, the sequence of connection is optional.
7. Sensor connection. Connect here the other wire of the external, i.e. surface sensor that can be used in the case of surface heating. The thermostat's sensor is not „phase-sensitive“, the sequence of connection is optional.
8. The nominal voltage level of the sensor connection point between points 6 and 7 is DC 3.3 V.

WIRING DIAGRAM

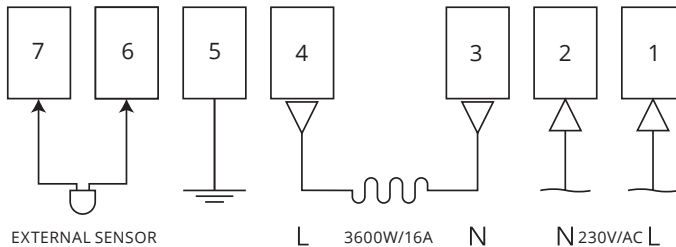

5. DISPLAY

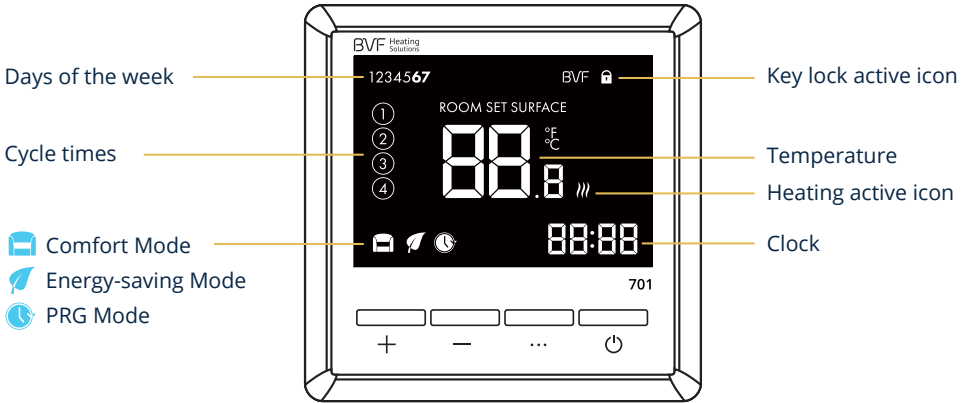



- + Increase temperature
- Decrease temperature

- ... Modes & Parameter
- ⏻ Power On / Off

With mains power supply provided, the BVF 701 thermostat can be turned on by pressing the right side lower button  once. Depending on the settings, the following values will appear on the display:

Days of the week – number of the current day; 1 – Monday, 2 – Tuesday, etc. The values can be set in the factory menu (8. point).

Cycle times – serial number of the current cycle time in program mode. The times and temperatures belonging to the program mode of operation can be set in the program menu.

- Modes of operation** –
-  comfort mode. When set, a constant temperature can be provided.
 -  energy-saving mode. When set, a constant temperature can be provided.
 -  program mode. When set, the time corresponding to the application and the related temperature can be set. Setting of the programming is detailed in menu point 7.

BVF logo – In the upper right corner of the display the **BVF** logo indicates the standby mode and it can be seen even in turned off, but live condition.

Keylock active icon – it appears when this function is turned on in the factory menu. Setting is detailed in point 8.

Temperature – depending on the setting it will display the current temperature of the room or the heating surface (floor or ceiling), or, when the word **SET** comes up, the temperature set.

ROOM SET SURFACE – when the word **ROOM** is displayed the number below it shows the current temperature of the room in °C, while in the case of the word **SURFACE** the number below it shows the current temperature of the heating surface (floor, ceiling) in °C. Depending on the settings, the word **SET** means the setting of the room's or heating surface's temperature, and when pressing the **+** or **-** button indicates the temperature to be achieved.

Heating active icon – if the setting temperature of the thermostat is higher than the current temperature of the room or the heating surface, the heating active icon can be seen. In this case the thermostat's relay makes the circuit and the voltage will get to the output point 4.

Time – displays the current time in hh:mm format. Setting of the time is detailed in point 7.





+ button – when pressed, the required temperature value can be raised in the turned on condition of the thermostat, or the current value of the factory settings menu point can be changed (see details in the programming menu point)

– button – when pressed, the required temperature value can be reduced in the turned on condition of the thermostat, or the current value of the factory settings menu point can be changed (see details in the programming menu point)

⋮ button – when pressed several times, the comfort, energy-saving and program modes of operation can be changed in the turned on condition of the thermostat, or, when depressed for a longer time, it will enter the programming settings menu.

⏻ button – by pressing it, the thermostat can be turned on and off.

6. FIX MODES OF OPERATION

When the  or  icon appears on the thermostat's starting screen in its turned on condition, set the temperature to be achieved by using the **+** or **–** button. Depending on the real temperature of the room (or, depending on the settings, the heating surface) the thermostat switches on and the  icon is displayed. Using these modes of operation, the temperature set on the thermostat (and to be achieved) will not change until the **+** or **–** button is pressed. The steady temperature values make quick setting possible to provide constant temperatures with time-independent, unchanged values. For the  or  modes of operation any temperature values can be set by pressing the **+** or **–** button.

7. PROGRAMMING

The basic purpose of the programming function is to ensure that the thermostat can activate heating at a time and temperature corresponding to user demands. The use of the programming function is recommended in general cases for permanently occupied properties such as family homes and apartments with independent heating systems. To access the program mode of operation turn on the thermostat, then set it to the  program mode by pressing (if necessary, several times) the **⋮** button.

For the settings press the **⋮** button for a longer time (3 seconds). In the right bottom corner of the display the time :pp (:mm) starts flashing. Pressing the **+** or **–** button set the minute value of the current time.

*A tip: by pressing the **+** or **–** button continuously the required value can be reached more quickly; one brief touching will change the value with one single minute.*

For approval and proceeding press the **⋮** button again briefly.

Now in the right bottom corner of the display the hh: part of the time starts flashing. Pressing the **+** or **–** button set the hour value of the current time.

*A tip: by pressing the **+** or **–** button continuously the required value can be reached more quickly; one brief touching will change the value with one hour.*

For approval and proceeding press the **⋮** button again briefly.

Now the number of the days of the week start flashing in the left upper corner of the display. Pressing the **+** or **–** button set the value of the appropriate day of the week (1 – Monday,

2 – Tuesday, etc.).

For approval and proceeding press the ... button again briefly.

Now in the left upper corner of the display the numbers indicating the weekdays, i.e. 12345 will appear. Also appears the ① (1st program cycle) icon, and the hh:mm indication in the right bottom corner starts flashing. Pressing the + or – button briefly (if necessary, repeatedly) set the starting time of the first program cycle chosen for the weekdays. For example, if you wish to start heating on each weekday (from Monday to Friday) at 07:00 o'clock in the morning, set the hh:mm value to 07:00. The times of the heating cycle can be set with an accuracy of 15 minutes. *A tip: by pressing the + or – button continuously, the desired value can be reached more quickly, and a single touch of the button will step the time in 15 minute periods.*

For approval and proceeding press the ... button again briefly.

In the middle of the display the temperature value will now start flashing. Pressing the + or – button briefly (if necessary, repeatedly) set the desired temperature value for the starting time of the program cycle valid for the weekdays. If, for example, you wish to reach a temperature of +21.5°C from 07:00 o'clock in the morning on the weekdays (from Monday to Friday), set the temperature value to 21.5°C. The temperature value can be set with an accuracy of 0.5°C.

A tip: by pressing the + or – button continuously, the desired value can be reached more quickly, a single brief touching of the button will change the temperature with 0.5°C.

For approval and proceeding press the ... button again briefly.

Now the ② (2nd program cycle) icon appears on the display and the hh:mm indication starts flashing in the right bottom corner. Just like above, set the next starting time of the daily program cycle. The start of the 2nd program cycle will logically indicate the end of the 1st program cycle, so, if, for example, the 2nd program cycle starts at 09:00 hours, the 1st program cycle ends at 09:00 hours. Just like in the previous case, set the desired temperature belonging to the 2nd program cycle, and, after the further steps, also set the values of the 3rd and the final 4th program cycles. When proceeding after setting the program cycle and pressing the ... button the number 6 (Saturday) appears in the left upper corner. The settings are the same as the weekday times and temperature values. After setting the values for day 6 (Saturday) and proceeding, the values for day 7 (Sunday) can be set in a similar way. After setting the last, 4th value for the 7 (Sunday) cycle time and pressing the ... button, the thermostat's display returns to the the starting screen. The program settings have been completed successfully.

An example of the settings for general programming. **Attention!** In the case of a heating system used on a daily basis it is recommended to set a difference of max. 3-4°C between the temperature values of the heated periods (when the dwellers are at home) and the non-heated periods. In case of a larger temperature difference the rooms can cool down to such an extent that heating them up would be impossible or require a very long time. This can reduce the feeling of comfort considerably.

DEFAULT VALUES

Period	Wake up ①		Leave Home ②		Return Home ③		Sleep ④	
	Time	Temp.	Time	Temp.	Time	Temp.	Time	Temp.
1-5 (Mon.-Fri.)	7:00	22°C	8:30	19°C	17:00	22°C	22:00	19°C
6 (Sat.)	8:00	22°C	8:30	22°C	17:00	22°C	22:00	19°C
7 (Sun.)	8:00	22°C	8:30	22°C	17:00	22°C	22:00	19°C

8. FACTORY SETTINGS MENU POINTS

The factory-set values can be checked and, if needed, modified by entering the factory menu. To enter the factory menu, first turn the thermostat off. The display will only show the **BVF** brand letters in the upper right corner. Now press and keep depressed at the same time the **+** and the **...** buttons for at least 5 seconds. On entering the first point of the factory menu will appear: by default the temperature numerical value shows 0.0°C and menu point 01 appears in the right bottom corner of the display. This menu makes it possible to set the difference between the temperature shown by the thermostat and the real temperature of the room. You can set the temperature difference with the correct sign by pressing the **+** or **-** button several times, as needed. If, for instance, the thermostat, when turned on, shows 21.5°C and the real temperature of the room is 20.0°C, then you have to set a value of -1.5°C in menu point 01 of the factory settings. For approval and proceeding press the **...** button once briefly. **Attention!** Saving of the settings will take place automatically even if no further steps follow and in about 15 seconds the thermostat will turn off. In the factory menu (after entering it again or setting menu 01 by pressing the **...** button) you can proceed always by pressing the **...** button briefly, and in the individual menu points you can use the **+** or **-** button for setting the values.

DEFAULT VALUES

	Description	Range	Default
01	Temp. Offset	-8°C ~ 8°C	0
02	Set Point Max.	5°C ~ 80°C	35°C
03	Set Point Min.	5°C ~ 80°C	5°C
04	Sensor Select	ROOM SURFACE Room + Surface	
05	Frost Protection Temp.	5°C ~15°C	5°C
06	Surface Temp. Display	Read Only	
07	High Temp. Protection	20°C ~ 80°C	32°C
08	Comfort Mode Floor Limit Temp. Set	5°C ~ 35°C	29°C
09	Energy-saving Mode Floor Limit Temp. Set	5°C ~ 35°C	27°C
10	PRG Mode Floor Limit Temp. Set	5°C ~ 35°C	29°C
11	Reset	rE (Yes)	
12	Key lock	0 - off, 1 - on	0
14	OWD function ON/OFF select	0 - off, 1 - on	0
15	OWD Detect Time Select	2 ~ 30 mins	15 mins
16	OWD Drop temp. select (within detect time)	2 / 3 / 4°C	2°C
17	OWD Delay time select (Return to previous working status)	10 ~ 60 mins	30 mins
18	The temp. diff to exit high protection mode	1°C ~ 3°C	1°C
19	External sensor temp. offset	-8°C ~ 8°C	0
20	Energy optimisation	1: electric radiator 2: heating panel	3: ceiling heating 4: floor heating
21	Brightness (Standby Mode)	0 - 100%	5%
22	Software version		



DETAILED DESCRIPTION OF THE MENU POINTS:

- 01 Calibration of the thermometer** – a true-to-sign difference between the value shown by the thermostat and the real temperature of the room. If, for example, the thermostat, when turned on, shows 21.5°C and the real temperature of the room is 20.0°C, then in menu point 01 of the factory settings a value of -1.5°C should be set.
- 02 Maximum temperature** – the maximum temperature value that can be set on the thermostat. No heating temperature higher than this value can be set on the device. The factory value is 35°C, and it can be varied between 5 and 80°C. The value set here will be the maximum of all the adjustable temperatures of the controller.
- 03 Minimum temperature** – the minimum temperature value that can be set on the thermostat. No heating temperature lower than this value can be set on the device.
- 04 Selection of sensor** – you can set the thermometer sensor on the basis of which the thermostat performs its control function.

When set to the **ROOM** value, the thermostat will use only the room thermometer on its control panel for measuring. This setting can be used in the case of controlling an infrapanel or electric radiator.

When set to the **SURFACE** value, the thermostat will only measure and display the heating surface's (floor or ceiling) temperature. A setting that can be used in the case of comfort or additional surface heating.

When set to the **ROOM + SURFACE** combined value, the thermostat will display the room's temperature and this can also be set, but the temperature of the heating surface (floor or ceiling) is also considered and it does not allow heating to a value higher than that even in the case when the room has not reached the desired temperature value. A setting recommended for floor or ceiling heating operated as an independent mode of heating.

- 05 Anti-freezing (also in turned off condition)** – in case of reaching the temperature set here the thermostat will turn heating on even in the case when it is otherwise switched off. This function can be used for antifreezing in the case of winterized holiday homes, or rooms and (office) buildings having been out of use for a longer period of time. The condition of using the antifreezing function is that the controller be electrically live (the BVF icon will appear in the right upper corner of the display even if the device is turned off).
- 06 Temperature of the external (surface) sensor** – a menu point suitable for setting the display of the temperature measured by the thermostat's surface sensor. This menu point is suitable only for checking and reading the value which can not be modified.
- 07 Overheating protection** – a setting necessary in the case of a surface heating (underfloor or ceiling heating). The value set here will be the maximum temperature of the heating surface. When set, for example, to 30°C, the underfloor heating will switch off when the floor reaches the 30°C temperature (even in the case when the room's temperature has not yet reached the desired value). With the surface cooling back by 2°C (based on the example, at a temperature of 28°C), heating will switch on again if the room temperature makes it necessary. The recommended setting values for underfloor heating are between 29-31°C, and for ceiling heating between 45-48°C.
- 08 Comfort mode limit** – the maximum room temperature value belongs to Comfort  mode. Higher value can not be set in the Comfort mode of thermostat.
- 09 Energy saving mode limit** – the maximum room temperature value belongs to Energy  saving mode. Higher value can not be set in the Energy saving mode of thermostat.

- 10 PRG mode limit** – the maximum room temperature value belongs to PRG  mode. Higher value can not be set in the PRG mode of thermostat.
- 11 Resetting the factory values** – resetting of the thermostat's factory values and settings. The factory values are contained in the table below.
- 12 Keyboard locking (child lock)** – 0 – off; 1 – on. In the turned on condition a  icon will appear in the display's right upper corner on the starting screen of the thermostat within 15 seconds after the last intervention (pressing of a button) and at the same time the child lock function will get activated and the device will not react upon touching any button. The keyboard lock function can be suspended by pressing the **+** and **-** buttons simultaneously and keeping them depressed for 5 seconds. In this way this function will only be broken (with breaks not longer than 15 seconds in the case of a continuous intervention); the keyboard lock can be resolved by setting point 12 of the factory menu to 0.
- 13 Inactive**
- 14 Sensing of open window** – 0 – off; 1 – on. When on, the open window function gets activated on the controller which means that upon a temperature drop occurring after a certain period of time the thermostat, supposing ventilation, will temporarily turn heating off in order to avoid unnecessary energy consumption. The delay in activating this function, the extent of temperature drop and the timing of switching heating on again can be set in menu points 15-16-17.
- 15 Period of sensing open window (switch-on delay)** – this function will switch on when the time set here has elapsed. For example, if the numerical value set in this menu is 15, heating will be turned off when within this 15-minute period the temperature has dropped with the specified temperature value.
- 16 Open window temperature drop (within sensing time)** – sensing limit value of the temperature drop. For instance, if the numerical value set in the menu is 2, then within the time frame set in menu 15 heating will switch off upon a 2°C temperature drop.
- 17 Open window delay period (returning to normal mode of operation)** – heating will be switched on again after the time specified here. If the numerical value of the menu is 30, it means that heating will be switched on again 30 minutes after the temperature drop has stopped.
An example of how the open window function works: the set values are: menu point 14 (1); menu point 15 (15); menu point 16 (2); menu point 17 (30). Based on the settings the open window function is active; in case of a temperature drop of 2°C occurring within 15 minutes the thermostat switches the heating off, and in 30 minutes after the temperature drop has ceased heating will be switched on again.
- 18 Cooling back limit after overheating** – a function that can be used with surface heating, in which heating will switch on when the temperature difference set here has been reached, having previously reached the surface's maximum value. For example, if the maximum surface value (menu point 7) is 29°C, the value set in menu 18 is 2°C, then heating will switch on again when the floor's surface temperature has cooled back to 27°C.
- 19 Calibrating the external sensor** – a function used with surface heating and based on the signed difference between the temperature measured by the surface sensor and the real temperature of the surface. For example, if in menu point 06 the thermostat shows +28°C, while the real temperature of the surface is 25°C, then menu point 19 should be set to -3°C.

- 20 Optimisation of energy consumption** – 1: *electric radiator*. Set it to this value if the heating controlled by the thermostat is an independent convection-type electric heating provided with built-in temperature controller (radiator). 2: *infrapanel*. Set it to this value if the heating controlled by the thermostat is an independent radiation heating provided with built-in surface temperature controller (infrapanel). 3: *ceiling heating*. Set it to this value if the heating controlled by the thermostat is an electric radiation ceiling surface heating. 4: *underfloor heating*. Set it to this value if the heating controlled by the thermostat is a low surface temperature electric underfloor heating.
- 21 Software version** – version number of the software (firmware) running on the thermostat. It is a read-only value.

10. TROUBLESHOOTING

Fault phenomena of thermostats and their possible solutions

1. The thermostat's display is dark, it is not lit

- a. Is there any change upon pressing the thermostat's turn-on button?
 - YES – The thermostat has turned on, there is nothing else to do.
 - NO – see next answer.
- b. Is there a  icon on the display?
 - YES – The child lock function is on. Turn off the child lock as described in the instructions manual.
 - NO – see next answer.
- c. Is the small circuit breaker of the heating circuit switched on?
 - NO – Switch it on.
 - YES – see next answer.
- d. Is there any change after removing the thermostat's front panel and trying to switch it on again?
 - YES – The thermostat has switched on, the ribbon cable has pressed the front panel; when replacing the front panel take care to insert the ribbon cable in the small gap on the rear side.
 - NO – see next answer.
- e. Is the front panel of the thermostat connected to the rear panel, i.e. is the ribbon cable connected?
 - NO – Connect it.
 - YES – see next answer.
- f. Is it possible to measure voltage on the phase input of the thermostat's built-in relay?
 - NO – The thermostat does not receive power. Have the power supply of the affected electrical circuit, the small circuit breakers, junction boxes and wires tested by an electrician.
 - YES – see next answer.

- g. **Is there any visible abnormal change, such as sooting, or signs of injury or damage to certain components, on the thermostat's relay or front panel?**

NO – The thermostat needs to be further examined, so please, send it to our central brand shop or order our on-site troubleshooting and repair service.

YES – The device has likely been hit by electrical overvoltage and it should partly or entirely be replaced. The thermostat needs further examination, so please, send it to our central brand shop or order our on-site troubleshooting and repair service.

2. **The display is lit, but heating is not working.**

- a. **Is it the real room temperature that can be seen on the display?**

NO – The thermostat needs calibration. Calibrate the device according to the description in the instructions manual.

YES – see next answer.

- b. **When the thermostat is turned on press the \oplus button so that the set value exceeds the room temperature. Is the heating icon appearing on the display in a few seconds with a soft clicking sound?**

YES – The thermostat switches on. If the system still does not heat, further settings are needed.

NO – see next answer.

- c. **Does the thermostat control a surface heating system?**

YES – Check the controller's surface limit values as described in the instructions manual. If necessary, the setting limit value can be increased. If the surface temperature shows an unrealistic value, further examination is required. If there is a piece of furniture, a carpet or other heat insulating material over the floor sensor of the thermostat, remove it so that the affected surface can give off heat. If there is no such a reason, the sensor might be damaged.

NO – The thermostat requires further examinations. Please, send it to our central brand shop or order our on-site troubleshooting and repair service.

3. **After switching on or increasing the temperature value the thermostat clicks, the heating icon is visible, but there is still no heating.**

- a. **Is the power of the heating circuit higher than 3 kW (13 A)?**

YES – the circuit in question is supplemented with a power switching relay. Please, ask your electrician to check the proper working of the power switching relay, or order our on-site troubleshooting service.

NO – see next answer.

- b. **Are the heating power supply wires connected to the built-in relay of the thermostat?**

NO – Ask your electrician to connect it or order our on-site troubleshooting service.

YES – see next answer.

- c. **Can you measure voltage on the thermostat's switched output?**

YES – The thermostat functions well, troubleshooting should be continued with further tests on the heating side.

NO – The thermostat requires further examination, so please, send it to our central brand shop or order our on-site troubleshooting and repair service.