

SPECIFICATION GUIDE

Effective February 2016. Supersedes all prior versions.



Aristokraft[®]
CABINetry

NEW PRODUCTS

- ▶ **Brellin Glacier Gray Door Style**, see page 21
- ▶ **Durham Glacier Gray Door Style**, see page 21
- ▶ **Durham White Door Style**, see page 21
- ▶ **Smart Stop™ Hinges and Drawer Guides** now standard on Select & APC construction platforms, see page 27
- ▶ **New Wall 14" and 18" high SKU cabinets** (W1214, W1218, WPG1214, WPG1218, W1514, W1518, WPG1514, WPG1518, WMD1518, W1814, W1818, WPG1814, WPG1818, WMD1818, W2114, W2118, WPG2114, WPG2118, WMD2118, W2414, WPG2414), see pages 40-55
- ▶ **New Microwave Open Cabinets** (MWOL2418, MWOL2718 and MWOL3018), see page 65
- ▶ **31" High Wood Hood Chimney** (WHCT30, WHCT36), see page 67
- ▶ **Chrome Tray Dividers Cabinets** (B09TD, B12TD) and new **Chrome Tray Divider Kit** (CTDK), see pages 83 and 167
- ▶ **New SKU nomenclature for Oven Cabinet** (OCSD), **Oven Cabinet Double** (OD), and **Oven with Microwave Cabinets** (OMS) and **Microwave Cabinets** (TMW), see pages 103-111
- ▶ **Trim Moulding** (MTW8, PSMTW8), see page 141
- ▶ **PureStyle Wrapped Mouldings** (PSMTBEAD8, PSMICROWN8, PSMFOLCR8, PSMTCROWN8, PSMTST8, PSMTCAP8, PSMTLR8, PSMSW8, PSMQR8, PSMCROWN8), see pages 141-145
- ▶ **Updated Paint pricing** to now match **Glaze trim pricing**, see pages 141-156
- ▶ **Frame Spacers** (HNGSPCRF, HNGSPCRF50), **Hinge Spacers** (HNGSPCRD, HNGSPCRD50), **Restrictor Clips** (HNGRESCLP), see page 169

DISCONTINUATIONS - Last Order Date January 29, 2016

- ▶ **Eastland Maple Arch**
- ▶ **Ellsworth PureStyle** - Last Order date 12/30/2015
- ▶ **Landen Oak**
- ▶ **Wentworth Cherry**
- ▶ **Center Mullion SKUs (27" - 36" Wide)**
- ▶ **FX - Full Extension Base, Tall, Vanity and Universal SKUs**
- ▶ **WOL2147.5**
- ▶ **B12TDRO**
- ▶ **MWS** (MWS2416 and MWS2718), replaced with MWOL cabinets
- ▶ **Multi-Case Moulding Packs** (MSW_, MSW_-, MOC_, MOC_-, MTBEAD_, MCROWN_-, MICROWN_-, MFOLCR_-, MSHKRCROWN_-, MCTR_-, MCTB_-, MCTOG_-, MCV_-, MQR_-, MQR_-, MBAT_-, MTST_-, MTCAP_-, MTLR_-, MLR_-, MTT_-, MTBAT_-, MDENTIL_-, MROPE_-, MBS_)
- ▶ **Keyboard Tray** (KTT30)
- ▶ **Cutting Board Kit** (CBK)
- ▶ **Hardware** (H308, H310, H320, H322, H331, H341, H342)
- ▶ **Lavatory Tip-Out Trays** (LTOT11, LTOT14)

TABLE OF CONTENTS

Product Description Index	2-3
Product Code Index	4-5
Characteristics of Wood	6
Characteristics of Paint and Laminate/Humidification Effects	7
Door Styles	8-19
Finish Descriptions and Process	20
Finish Availability	21
Door Style Numbers	22-25
Common Style Numbers	26
Construction – Core and Plus	27
Ordering Information	28
Mullion Door Information	29
Cabinet Specifications	30-33
Design Checklist/Tips to the Installer	34
NKBA Guidelines	35-36
Organization Solutions	37
Moulding Solutions	38-39
Wall Cabinets	40-82
Wall Cabinets/Straight	40-65
Wall Cabinets/Wood Hoods	66-69
Wall Cabinets/Corner	70-78
Wall Cabinets/End	79
Wall Cabinets/Peninsula	80-82
Base Cabinets	83-102
Base Cabinets/Straight	83-90
Base Cabinets/Sink	91-93
Base Cabinets/Drawer	94-95
Base Cabinets/Microwave	95
Base Cabinets/Corner	96-99
Base Cabinets/End	100
Base Cabinets/Peninsula	101-102
Tall Cabinets	103-116
Other Room Cabinets	117-119
Vanity Cabinets	120-134
Universal Design Cabinets	135-140
Mouldings & Trim	141-158
Accessories & Parts	159-178
Warped Door Policy/Cabinet Care Suggestions	179
Policies/Information	180
Warranty	181

Desc	Code	Page	Desc	Code	Page
Acanthus Overlay	ACOVLY	149	Filler Fluted	FFL	147
Angled Fluted Filler	BLVDF	147	Filler Reeded	FF	147
Angled Heat Shield	HEATSHIELDAN	164	Filter for Wood Hood Blower	FILTER	69
Appliance Center	AC	160	Four Drawer Base	DB-4	94
Art Corbel	CORBELART	150	Four Drawer Base w/False Panel	DBFP-4	94
Base Box Column Pull-Out Cabinet	BBCPO	87	Frame Spacer	HNGSPCRF	169
Base Built-In Microwave Cabinet	BMW	95	French Leg	FRNLEG	151
Base Built-In Microwave Cabinet Universal Design	BMW..32.5	139	Full Overlay Crown Moulding	PMFOLCR8	142
Base Cabinet	B	83	Full Overlay Crown Moulding PureStyle™	PSMFOLCR8	142
Base Cabinet Universal Design	B..32.5	135	Glass Shelf Kit	GSK	163
Base Cabinet w/Butt Doors	B..B	83	Hardware	H	171
Base Cabinet w/Butt Doors Universal Design	B..32.5B	135	Hinge Angle Restrictor Clip	HNGRESCLP	169
Base Cabinet w/Doors Prepped for Glass	BPG	89	Hinge Spacer	HNGSPCRD	169
Base Cabinet w/Double Roll Tray	B..RT-2	84	Insert Crown Moulding	MICROWN8	142
Base Cabinet w/Double Roll Trays & Butt Doors	B..RT2B	84	Insert Crown Moulding PureStyle™	PSMICROWN8	142
Base Cabinet w/Full Height Butt Doors	B..FHB	87	Island Leg	ISLEG	152
Base Cabinet w/Full Height Butt Doors, 12" Deep	B..FH-12B	86	Kneespace Drawer	KDT	119
Base Cabinet w/Full Height Butt Doors Universal Design	B..32.5FHB	135	Laminate End Panel	EPA	156
Base Cabinet w/Full Height Doors	B..FH	86	Large Corbel	LGCORBEL	151
Base Cabinet w/Full Height Doors, 12" Deep	B..FH-12	86	Light Rail Moulding	MLR	145
Base Cabinet w/Full Height Doors Universal Design	B..32.5FH	135	Linen Closet Shelf Kit	LKS	134
Base Cabinet w/Mullion Doors	BMD	88	Linen Closet SuperCabinet™ w/Removable Hamper	LCD..SC	133
Base Cabinet w/Roll Tray	B..RT	84	Linen Closet w/Drawer	LCD	132
Base Cabinet w/Roll Tray & Butt Doors	B..RTB	84	Microwave Cabinet	TMW	106
Base Cabinet w/Tray Divider	B..TD	83	Microwave Wall Open Shelf	MWOL	65
Base Corner	BC	99	Microwave Wall Cabinet w/Butt Doors	MWC..B	63
Base Corner Cabinet Universal Design	BC..32.5	139	Mission Corbel	CORBELMIS	150
Base Corner Filler	FBC	147	Organizer Shelves	ORG	160
Base End Cabinet	BEC	100	Outside Corner Moulding	MOCW	141
Base End Cabinet	BECF	100	Oven Cabinet w/Butt Doors	OCSD..B	103
Base Lazy Susan	BLS	97	Oven Installation Kit	OCINSTALLKIT	164
Base Lazy Susan Universal Design	BLS..32.5	137	Oven with Microwave Cabinet	OMS	109
Base Open Cabinet	BOL	88	Overlay	OL	148
Base Pantry Pull-Out Cabinet	BPP	87	Pantry Roll Tray Kit	UPK	166
Base Pots & Pans Pull-Out	BPPP	90	Pantry SuperCabinet™	PSC	112
Base Roto Easy Reach Cabinet	BRER	96	Pantry SuperCabinet™ w/Butt Doors	PSC..B	112
Base Shoe Moulding	MBS8	146	Pegged Dish Organizer	PDO	162
Base SuperCabinet™ Pull-Out/Roll-Out w/Butt Doors	BSC..PRB	85	Pegged Dish Organizer Posts	PDOPOSTS	162
Base SuperCabinet™ Pull-Out/Roll-Out/Pull-Out w/Butt Doors	BSC..RPB	86	Peninsula Base	PB	101
Base SuperCabinet™ Roll-Out/Pull-Out w/Butt Doors	BSC..RPB	85	Peninsula Base Square Corner Cabinet	PBSC	101
Base Wastebasket	BWB	90	Peninsula Base Square Corner Cabinet w/Butt Doors	PBSC..B	101
Base Wastebasket w/Full Height Doors	BWB..FH	90	Peninsula Base w/Butt Doors	PB..B	101
Batten Moulding	MBAT8	144	Peninsula Wall Cabinet	PW	80
Beadboard Panel	BP	155	Peninsula Wall Cabinets w/Butt Doors Prepped for Glass	PWPG..B	82
Bookcase Base	BKB	118	Peninsula Wall Cabinet w/Butt Doors	PW..B	80
Bookcase Base w/Butt Doors	BKB..B	118	Peninsula Wall Cabinet w/Mullion Butt Doors	PWMD..B	81
Bookcase	BK	117	Pint of Stain	STAINPT	170
Bookshelf Kit	BKSHELFKIT	159	Pint of Toner	TONERPT	170
CabMat™	CABMAT36	163	Plastic Cutlery Drawer Tray	PCDT	162
Canopy Wood Hood, Arch	WHCA	66	Plywood End Panel w/Stile	PEPRPLY	154
Chrome Tray Divider Kit	CTDK	167	Plywood Refrigerator End Panel w/Stile	PREPRP	154
Counter Top Moulding Bevel	MCTB	143	Quarter Round Moulding	MQR8	144
Counter Top Moulding Ogee	MCTOG	143	Quarter Round Moulding PureStyle™	PSMQR8	144
Counter Top Moulding Radius	MCTR8	143	Quart of Stain	STAINQT	170
Country Sink Base w/Butt Doors	CNTYSB..B	92	Range Panel	RP	158
Cove Moulding	MCV	144	Reed Leg	RDLEG	152
Crown Moulding	MCROWN8	142	Refrigerator End Panel	PREF	154
Crown Moulding PureStyle™	PSMCROWN8	142	Refrigerator End Panel w/Stile	PREPR	154
Decorative Angled/Fluted/Plain Filler	F.A	147	Refrigerator Wall Cabinet	RW	59
Decorative Base End Panel	DBEP	157	Refrigerator Wall Cabinet w/Butt Doors	RW..B	59
Decorative Dishwasher Panel	DDWP	157	Removable Vanity Wall Sink Cabinet	RVWS	140
Decorative End Panel Full Height	DBEPFH	157	Roll Tray Bumper Pad	RTBP	167
Decorative End Panel Full Height, 12" Deep	DBEPFH-12	157	Roll Tray Kit	TKIT	166
Decorative Mission Leg	DLEGMISSION	152	Rope Moulding	MROPE8	146
Decorative Peninsula Base End Panel	DPBEP	157	Rosette	FFROS	149
Decorative Utility End Panel	DUEP	157	Shaker Crown Moulding	MSHKRCROWN8	142
Decorative Vanity End Panel	DVEP	157	Sink Base Diagonal Corner Cabinet	SBDC	92
Decorative Wall End Panel	DWEP	157	Sink Base SuperCabinet™ w/Butt Doors	SB..STNSB	92
Dentil Moulding	MDENTIL	146	Sink Base SuperCabinet™ w/Butt Doors	SB..STSB	91
Diagonal Corner Peninsula Wall Cabinet	PDC	82	Sink Base w/Butt Doors Universal Design	SB..32.5B	136
Diagonal Corner Roto Wall Cabinet	DCR	75	Sink Front Corner	SFC	93
Diagonal Corner Wall Cabinet	DC	70	Sink Front End Panel	PSFEP	154
Diagonal Corner Wall Open Cabinet	DCOL	71	Sink Front Universal Design	SF..32.5	136
Diagonal Corner Wall Prepped for Glass	DCPG	73	Sink Front w/Butt Doors Universal Design	SF..32.5B	136
Diagonal Corner Wall w/Mullion Doors	DCMD	72	Sink/Range Base	SB	91
Diagonal Glass Shelf Kit	GSKDC	163	Sink/Range Base w/Butt Doors	SB..B	91
Dishwasher Panel	PDWP	154	Sink/Range Front	SF	93
Double Oven Cabinet w/Butt Doors	OD..B	104	Sink/Range Front w/Butt Doors	SF..B	93
Double Wastebasket Roll-Out Kit	DWBR	167	Sink Tip-Out Tray, 1 Front	STOT..WHB	168
End Panel w/Stile	PEPR	154	Sink Tip-Out Tray, 2 Fronts	STOT..WH	168
English Bar Column Leg	ENGBARCOLUMN	152	Sink Unit w/Front Panel Universal Design	SU..32.5	136
English Island Column Leg	ENGLCOLUMN	152	Small Corbel	SMCORBEL	151
Filler	F	147	Small Cove Crown Moulding	MSMCOVECR8	142
			Smart Stop™ Doors Mechanism	SSDM	168
			Soffit Filler Moulding	MSFM8	143
			Split Turning End	SFRINGEND	149

Desc	Code	Page	Desc	Code	Page
Split Turning Reed	REED	149	Wine Cube Drawer	WCUBEDRW	65
Split Turning Spool	SPOOL	149	Wine Rack Cabinet	WR	61
Square Corner/Base Roto Easy Reach Cabinet	SCER	96	Wood Cutlery Drawer Tray	WCDT	162
Square Corner Roto Base	SCR	96	Wood Hood Blower	TWHBLOWER	68
Square Corner Roto Base Universal Design	SCR..32.5	137	Wood Hood Chimney	WHC	67
Square Corner Wall Cabinet	SC	77	Wood Hood Chimney Tall	WHCT	67
Square Corner Wall Cabinet w/Butt Doors	SC..B	77	Wood Hood Contemporary Straight	WHCONSTR	67
Starter Moulding	MSTR8	143	Wood Hood Conversion Kit	TWHCONVKIT	69
Stem Glass Holder	SGH	160	Wood Hood Square	WHS	68
Stock Panel - Aristex™ Laminate	PA	155	Wood Scribe Moulding	MSW8	141
Stock Panel - Veneer	P	155	Wood Scribe Moulding PureStyle™	PSMSW8	141
Stock Panel - Veneer	PP	155	6-way Adjustable Hinge	HINGE6WAY	168
Straight Heat Shield	HEATSHIELDST	164			
Tall Crown Moulding	MTCROWN8	142			
Tall Crown Moulding PureStyle™	PSMTCROWN8	142			
Tall Light Rail Moulding	MLR8	145			
Tall Light Rail Moulding PureStyle™	PSMLR8	145			
Tapered Leg	TAPLEG	151			
Tapered Wood Hood	TWH	66			
Three Drawer Base	DB	94			
Three Drawer Base Universal Design	DB..32.5	137			
Three Drawer Base w/False Panel	DBFP	95			
Toe Kick	TOEKICK	158			
Toe Kick Cap	TKC	159			
Toe Kick Filler	TKF	147			
Toe Kick Tulip Foot	TKTLFOOT	151			
Touch-Up Kit	TUKIT	170			
Touch-Up Spray Can	TUPSPRAY	170			
Touch-Up Stick	TUPSTICK	170			
Traditional Batten Moulding	MTBAT8	146			
Traditional Cap Moulding	MTCAP8	145			
Traditional Cap Moulding PureStyle™	PSMTCAP8	145			
Traditional Soffit Trim Moulding	MTST8	144			
Traditional Soffit Trim Moulding PureStyle™	PSMTST8	144			
Traditional Trim Moulding	MTT8	145			
Trim Moulding	MTW8	141			
Trim Moulding PureStyle™	PSMTW8	141			
Triple Bead Moulding	MTBEAD8	141			
Triple Bead Moulding PureStyle™	PSMTBEAD8	141			
Utility Cabinet	U	114			
Utility Cabinet w/Butt Doors	U..B	114			
Utility Shelf Kit	UKS	165			
Valance Arch	V..RA	153			
Valance Corbel	VCORBEL	150			
Valance Scalloped	V..SC	153			
Valance Straight	V..ST	153			
Vanity Base	VB	120			
Vanity Base Pull-Out	VBP	121			
Vanity Base w/Butt Doors	VB..B	121			
Vanity Console Base	VCB	120			
Vanity Console Base w/Butt Doors	VCB..B	120			
Vanity Doors & Drawer Base	VDD	122			
Vanity Double Drawer Base Trimmable	VDDBT	124			
Vanity Double Drawer Base	Vddb	123			
Vanity Drawer Trimmable	VDT	131			
Vanity File Drawer	VFD	119			
Vanity File Drawer Base	VFDB	118			
Vanity Four Drawer Base	VDB-4	128			
Vanity Medicine Cabinet	VMC	133			
Vanity Sink Base	VSb	124			
Vanity Sink Base SuperCabinet™ w/Butt Doors	VSb..STNSB	127			
Vanity Sink Base SuperCabinet™ w/Butt Doors	VSb..STSB	126			
Vanity Sink Base w/Butt Doors	VSb..B	124			
Vanity Sink Drawer Base Trimmable	VSDBT	128			
Vanity Sink Drawer Base	VSDb	127			
Vanity Tank Topper	VTT	131			
Vanity Tapered End Panel	VTEP	158			
Vanity Three Drawer Base	VDB	128			
Vanity Tri-View Medicine Cabinet	VTMC	133			
Vanity Wall Cabinet	VWC	130			
Vanity Wall Sink Cabinet	VWS	140			
Veneer End Panel	EPV	156			
Wall Cabinet	W	40			
Wall Cabinet w/Butt Doors	W..B	40			
Wall Cabinet w/Butt Doors Prepped for Glass	WPG..B	56			
Wall Cabinet w/Doors Prepped for Glass	WPG	54			
Wall Cabinet w/Mullion Doors	WMD	49			
Wall Cabinet w/Mullion Butt Doors	WMD..B	50			
Wall Drawer Unit	WD	62			
Wall Easy Reach Cabinet	WER	75			
Wall End Cabinet	WEC	79			
Wall End Cabinet	WECL	79			
Wall Message Center Cabinet	WMC	62			
Wall Open Cabinet	WOL	45			
Wall Plate Rack Cabinet	WPR	61			
Wall Spice Rack	SRD	161			
Wall System Shelf	WSS	159			
What-Not Shelf	WN	65			
Wine Cube	WCUBE	65			

Code	Description	Page	Code	Description	Page
AC	Appliance Center	160	HNGSPCRD	Hinge Spacer	169
ACOVLY	Acanthus Overlay	149	HNGSPCRF	Frame Spacer	169
B	Base Cabinet	83	HNGRESCLP	Hinge Angle Restrictor Clip	169
B..32.5	Base Cabinet Universal Design	135	ISLEG	Island Leg	152
B..B	Base Cabinet w/Butt Doors	83	KDT	Kneespace Drawer	119
B..32.5B	Base Cabinet w/Butt Doors Universal Design	135	LCD	Linen Closet w/Drawer	132
B..FH	Base Cabinet w/Full Height Doors	86	LCD..SC	Linen Closet SuperCabinet™ w/Removable Hamper	133
B..32.5FH	Base Cabinet w/Full Height Doors Universal Design	135	LGCORBEL	Large Corbel	151
B..FHB	Base Cabinet w/Full Height Butt Doors	87	LKS	Linen Closet Shelf Kit	134
B..32.5FHB	Base Cabinet w/Full Height Butt Doors Universal Design	135	MBAT8	Batten Moulding	144
B..FH-12	Base Cabinet w/Full Height Doors, 12" Deep	86	MBS8	Base Shoe Moulding	146
B..FH-12B	Base Cabinet w/Full Height Butt Doors, 12" Deep	86	MCROWN8	Crown Moulding	142
B..RT-2	Base Cabinet w/Double Roll Tray	84	MCTB8	Counter Top Moulding Bevel	143
B..RT	Base Cabinet w/Roll Tray	84	MCTOG8	Counter Top Moulding Ogee	143
B..RT2B	Base Cabinet w/Double Roll Trays & Butt Doors	84	MCTR8	Counter Top Moulding Radius	143
B..RTB	Base Cabinet w/Roll Tray & Butt Doors	84	MCV8	Cove Moulding	144
B..TD	Base Cabinet w/Tray Divider	83	MDENTIL8	Dentil Moulding	146
BBCPO	Base Box Column Pull-Out Cabinet	87	MFOLCR8	Full Overlay Crown Moulding	142
BC	Base Corner	99	MICROWN8	Insert Crown Moulding	142
BC..32.5	Base Corner Cabinet Universal Design	139	MLR8	Light Rail Moulding	145
BEC	Base End Cabinet	100	MOCW8	Outside Corner Moulding	141
BEFC	Base End Cabinet	100	MQR8	Quarter Round Moulding	144
BK	Bookcase	117	MROPE8	Rope Moulding	146
BKB	Bookcase Base	118	MSFM8	Soffit Filler Moulding	143
BKB..B	Bookcase Base w/Butt Doors	118	MSHKRCROWN8	Shaker Crown Moulding	142
BKSHELFKIT	Bookshelf Kit	159	MSMCOVECR8	Small Cove Crown Moulding	142
BLS	Base Lazy Susan	97	MSTR8	Starter Moulding	143
BLS..32.5	Base Lazy Susan Universal Design	137	MSW8	Wood Scribe Moulding	141
BLVDF	Angled Fluted Filler	147	MTBAT8	Traditional Batten Moulding	146
BMD	Base Cabinet w/Mullion Doors	88	MTBEAD8	Triple Bead Moulding	141
BMW	Base Built-In Microwave Cabinet	95	MTCAP8	Traditional Cap Moulding	145
BMW..32.5	Base Built-In Microwave Cabinet Universal Design	139	MTCROWN8	Tall Crown Moulding	142
BOL	Base Open Cabinet	88	MTLR8	Tall Light Rail Moulding	145
BP	Beadboard Panel	155	MTST8	Traditional Soffit Trim Moulding	144
BPG	Base Cabinet w/Doors Prepped for Glass	89	MTT8	Traditional Trim Moulding	145
BPP	Base Pantry Pull-Out Cabinet	87	MTW8	Trim Moulding	141
BPPP	Base Pots & Pans Pull-Out	90	MWC..B	Microwave Wall Cabinet w/Butt Doors	63
BRER	Base Roto Easy Reach Cabinet	96	MWOL	Microwave Wall Open Shelf	65
BSC..PRB	Base SuperCabinet™ Pull-Out/Roll-Out w/Butt Doors	85	OCS..B	Oven Cabinet w/Butt Doors	103
BSC..RPB	Base SuperCabinet™ Pull-Out/Roll-Out/Pull-Out w/Butt Doors	86	OD..B	Double Oven Cabinet w/Butt Doors	104
BSC..RPB	Base SuperCabinet™ Roll-Out/Pull-Out w/Butt Doors	85	OCINSTALLKIT	Oven Installation Kit	164
BWB	Base Wastebasket	90	OMS	Oven with Microwave Cabinet	109
BWB..FH	Base Wastebasket w/Full Height Doors	90	OL	Overlay	148
CABMAT36	CabMat™	163	ORG	Organizer Shelves	160
CNTYSB..B	Country Sink Base w/Butt Doors	92	P	Stock Panel - Veneer	155
CORBELART	Art Corbel	150	PA	Stock Panel - Aristex™ Laminate	155
CORBELMIS	Mission Corbel	150	PB	Peninsula Base	101
CTDK	Chrome Tray Divider Kit	167	PB..B	Peninsula Base w/Butt Doors	101
DB	Three Drawer Base	94	PBSC	Peninsula Base Square Corner Cabinet	101
DB..32.5	Three Drawer Base Universal Design	137	PBSC..B	Peninsula Base Square Corner Cabinet w/Butt Doors	101
DB-4	Four Drawer Base	94	PCDT	Plastic Cutlery Drawer Tray	162
DBEP	Decorative Base End Panel	157	PDC	Diagonal Corner Peninsula Wall Cabinet	82
DBFP	Three Drawer Base w/False Panel	95	PDO	Pegged Dish Organizer	162
DBFP-4	Four Drawer Base w/False Panel	94	PDOPOSTS	Pegged Dish Organizer Posts	162
DBEPFH	Decorative End Panel Full Height	157	PDWP	Dishwasher Panel	154
DBEPFH-12	Decorative End Panel Full Height, 12" Deep	157	PEPR	End Panel w/Stile	154
DC	Diagonal Corner Wall Cabinet	70	PEPRPLY	Plywood End Panel w/Stile	154
DCMD	Diagonal Corner Wall w/Mullion Doors	72	PP	Stock Panel - Veneer	155
DCOL	Diagonal Corner Wall Open Cabinet	71	PREF	Refrigerator End Panel	154
DCPG	Diagonal Corner Wall Prepped for Glass	73	PREPR	Refrigerator End Panel w/Stile	154
DCR	Diagonal Corner Roto Wall Cabinet	75	PREPRP	Plywood Refrigerator End Panel w/Stile	154
DDWP	Decorative Dishwasher Panel	157	PSC	Pantry SuperCabinet™	112
DLEMISSION	Decorative Mission Leg	152	PSC..B	Pantry SuperCabinet™ w/Butt Doors	112
DPBEP	Decorative Peninsula Base End Panel	157	PSFEP	Sink Front End Panel	154
DUEP	Decorative Utility End Panel	157	PSMCROWN8	Crown Moulding PureStyle™	142
DVEP	Decorative Vanity End Panel	157	PSMFOLCR8	Full Overlay Crown Moulding PureStyle™	142
DWBR	Double Wastebasket Roll-Out Kit	167	PSMICROWN8	Insert Crown Moulding PureStyle™	142
DWEP	Decorative Wall End Panel	157	PSMQR8	Quarter Round Moulding PureStyle™	144
ENGBARCOLUMN	English Bar Column Leg	152	PSMSW8	Wood Scribe Moulding PureStyle™	141
ENGISLCOLUMN	English Island Column Leg	152	PSMTBEAD8	Triple Bead Moulding PureStyle™	141
EPA	Laminate End Panel	156	PSMTCAP8	Traditional Cap Moulding PureStyle™	145
EPV	Veneer End Panel	156	PSMTCROWN8	Tall Crown Moulding PureStyle™	142
F	Filler	147	PSMTLR8	Tall Light Rail Moulding PureStyle™	145
F..A	Decorative Angled/Fluted/Plain Filler	147	PSMTST8	Traditional Soffit Trim Moulding PureStyle™	144
FBC	Base Corner Filler	147	PSMTW8	Trim Moulding PureStyle™	141
FF	Filler Reeded	147	PW	Peninsula Wall Cabinet	80
FFL	Filler Fluted	147	PW..B	Peninsula Wall Cabinet w/Butt Doors	80
FFROS	Rosette	149	PWMD..B	Peninsula Wall Cabinet w/Mullion Butt Doors	81
FILTER	Filter for Wood Hood Blower	69	PWPG..B	Peninsula Wall Cabinets w/Butt Doors Prepped for Glass	82
FRNLEG	French Leg	151	RDLEG	Reed Leg	152
GSK	Glass Shelf Kit	163	REED	Split Turning Reed	149
GSKDC	Diagonal Glass Shelf Kit	163	RP	Range Panel	158
H	Hardware	171	RTBP	Roll Tray Bumper Pad	167
HEATSHIELDAN	Angled Heat Shield	164	RVWS	Removable Vanity Wall Sink Cabinet	140
HEATSHIELDST	Straight Heat Shield	164	RW	Refrigerator Wall Cabinet	59
HINGE6WAY	6-way Adjustable Hinge	168	RW..B	Refrigerator Wall Cabinet w/Butt Doors	59
			SB	Sink/Range Base	91
			SB..B	Sink/Range Base w/Butt Doors	91

Code	Description	Page	Code	Description	Page
SB..32.5B	Sink Base w/Butt Doors Universal Design	136	WN	What-Not Shelf	65
SB..STNSB	Sink Base SuperCabinet™ w/Butt Doors	92	WOL	Wall Open Cabinet	45
SB..STSB	Sink Base SuperCabinet™ w/Butt Doors	91	WPG	Wall Cabinet w/Doors Prepped for Glass	54
SBDC	Sink Base Diagonal Corner Cabinet	92	WPG..B	Wall Cabinet w/Butt Doors Prepped for Glass	56
SC	Square Corner Wall Cabinet	77	WPR	Wall Plate Rack Cabinet	61
SC..B	Square Corner Wall Cabinet w/Butt Doors	77	WR	Wine Rack Cabinet	61
SCER	Square Corner/Base Roto Easy Reach Cabinet	96	WSS	Wall System Shelf	159
SCR	Square Corner Roto Base	96			
SCR..32.5	Square Corner Roto Base Universal Design	137			
SF	Sink/Range Front	93			
SF..32.5	Sink Front Universal Design	136			
SF..B	Sink/Range Front w/Butt Doors	93			
SF..32.5B	Sink Front w/Butt Doors Universal Design	136			
SFC	Sink Front Corner	93			
SGH	Stem Glass Holder	160			
SMCORBEL	Small Corbel	151			
SPOOL	Split Turning Spool	149			
SPRINGEND	Split Turning End	149			
SRD	Wall Spice Rack	161			
SSDM	Smart Stop™ Doors Mechanism	168			
STAINPT	Pint of Stain	170			
STAINQT	Quart of Stain	170			
STOT..WH	Sink Tip-Out Tray, 2 Fronts	168			
STOT..WHB	Sink Tip-Out Tray, 1 Front	168			
SU..32.5	Sink Unit w/Front Panel Universal Design	136			
TAPLEG	Tapered Leg	151			
TKC	Toekick Cap	159			
TKF	Toekick Filler	147			
TKIT	Roll Tray Kit	166			
TKTLFOOT	Toekick Tulip Foot	151			
TMW	Microwave Cabinet	106			
TOEKICK	Toekick	158			
TONERPT	Pint of Toner	170			
TUKIT	Touch-Up Kit	170			
TUPSPRAY	Touch-Up Spray Can	170			
TUPSTICK	Touch-Up Stick	170			
TWH	Tapered Wood Hood	66			
TWHBLOWER	Wood Hood Blower	68			
TWHCONVKIT	Wood Hood Conversion Kit	69			
U	Utility Cabinet	114			
U..B	Utility Cabinet w/Butt Doors	114			
UKS	Utility Shelf Kit	165			
UPK	Pantry Roll Tray Kit	166			
V..RA	Valance Arch	153			
V..SC	Valance Scalloped	153			
V..ST	Valance Straight	153			
VB	Vanity Base	120			
VB..B	Vanity Base w/Butt Doors	121			
VBP	Vanity Base Pull-Out	121			
VCB	Vanity Console Base	120			
VCB..B	Vanity Console Base w/Butt Doors	120			
VCORBEL	Valance Corbel	150			
VDB	Vanity Three Drawer Base	128			
VDB-4	Vanity Four Drawer Base	128			
VDD	Vanity Doors & Drawer Base	122			
Vddb	Vanity Double Drawer Base	123			
VDDBT	Vanity Double Drawer Base Trimmable	124			
VDT	Vanity Drawer Trimmable	131			
VFD	Vanity File Drawer	119			
VFDB	Vanity File Drawer Base	118			
VMC	Vanity Medicine Cabinet	133			
VS	Vanity Sink Base	124			
VS..B	Vanity Sink Base w/Butt Doors	124			
VS..STNSB	Vanity Sink Base SuperCabinet™ w/Butt Doors	127			
VS..STSB	Vanity Sink Base SuperCabinet™ w/Butt Doors	126			
VSDB	Vanity Sink Drawer Base	127			
VSDBT	Vanity Sink Drawer Base Trimmable	128			
VTEP	Vanity Tapered End Panel	158			
VTMC	Vanity Tri-View Medicine Cabinet	133			
VTT	Vanity Tank Topper	131			
VWC	Vanity Wall Cabinet	130			
VWS	Vanity Wall Sink Cabinet	140			
W	Wall Cabinet	40			
W..B	Wall Cabinet w/Butt Doors	40			
WCDT	Wood Cutlery Drawer Tray	162			
WCUBE	Wine Cube	65			
WCUBEDRW	Wine Cube Drawer	65			
WD	Wall Drawer Unit	62			
WEC	Wall End Cabinet	79			
WECL	Wall End Cabinet	79			
WER	Wall Easy Reach Cabinet	75			
WHC	Wood Hood Chimney	67			
WHCT	Wood Hood Chimney Tall	67			
WHCA	Canopy Wood Hood, Arch	66			
WHCONSTR	Wood Hood Contemporary Straight	67			
WHS	Wood Hood Square	68			
WMC	Wall Message Center Cabinet	62			
WMD	Wall Cabinet w/Mullion Doors	49			
WMD..B	Wall Cabinet w/Mullion Butt Doors	50			

Wood Types

No matter which wood type you choose for your new kitchen or bath cabinetry, please keep in mind that no two pieces of wood are exactly the same. Stains are likely to exaggerate the difference between open and closed grains and other markings in wood. Grain variation and color change should be expected. As hardwood ages, it will darken when exposed to different types of light. Color differences or changes in wood can also be caused by exposure to harsh chemicals, extreme heat, or other contributing external conditions. Additionally, wood species exhibit other defining characteristics, such as mineral deposits/streaks, knots, sap runs, pin holes, and wormholes. These markings make the wood unique and contribute to its enduring beauty.



Cherry

- ▶ Top-of-the-line hardwood with a rich, natural reddish-brown tone
- ▶ Uniform tight grain allows finishes to be applied with ease
- ▶ Characteristics include mineral streaks, pin knots, and curly graining
- ▶ Darkens with age and exposure to light
- ▶ Smooth wood grain pattern with random markings



Maple

- ▶ Strong, resilient wood with a uniform tight grain and smooth, even appearance
- ▶ Mineral streaks are common and will appear darker with stain
- ▶ Subtle wood grain markings include fine lines and wavy or curly graining
- ▶ Small, black "bird's eye" dots



Oak

- ▶ Very strong wood with distinct grain patterns
- ▶ Grain variations create a color gradation when stain is applied
- ▶ Grain patterns include fine lines, pin stripes, leafy grains, and watery figures



Birch

- ▶ Even-textured, fine-grained wood with a curly or wavy pattern
- ▶ Strong with a high resistance to abrasion
- ▶ Smooth, dense surface texture
- ▶ Tight wood grain appearance



Hickory

- ▶ Smooth, extremely strong, close-grained wood with a flowing grain pattern
- ▶ Characteristics include pecks, mineral streaks, and burls
- ▶ Even texture welcomes a full range of finishes with ease
- ▶ Drastic changes from light to dark in wood grain
- ▶ Dramatic, rugged appearance

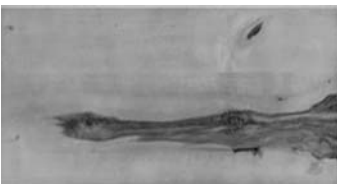

Rustic Characteristics

Solid Wood Doors and Drawer Fronts, may have varying amounts of the following:

- ▶ Sound Closed Knot (stable / not moveable) – Acceptable up to 3" in diameter
- ▶ Sound Knot with Cracks – Acceptable up to 2" in diameter, with open portion not to exceed $\frac{3}{4}$ " in diameter or length. May be completely visible through to back side of door.
- ▶ Open Knot – Acceptable up to $\frac{3}{4}$ " in diameter or length of open portion of knot. May be completely visible through to back side of door. (Note: Holes created by open knots are acceptable and desirable for this rustic look.)
- ▶ Unsound Knot (loose / moveable) – Unacceptable
- ▶ Knot Cluster (cluster of tight, sound knots) – Acceptable in all sizes and quantities
- ▶ Season Checks (crack) – Acceptable, as long as light does not pass through opening
- ▶ Worm / Pin Holes – Acceptable if present on less than 50% of door and less than $\frac{1}{4}$ " in diameter. May be completely visible through to back side of door.
- ▶ Worm Tracks – Acceptable if present on less than 50% of door and less than $\frac{1}{8}$ " in diameter and 8" in length
- ▶ Mineral Stains / Streaks / Deposits – Acceptable if present on less than 50% of door. May be black or brown in color.
- ▶ Natural Wood Figuring – Acceptable to have bird's eye, curly graining, burl graining or tiger striping if present on less than 50% of door

Veneer Panels / Mouldings / Other Trim Items:

- ▶ Will have few to no sound closed knots, sound knots with cracks, open knots, or knot clusters
- ▶ May have some visible worm / pin holes, mineral stains / streaks / deposits, or natural wood figuring

Characteristics of Paint

Paint will develop hairline cracks in the finish, most notable around the joints. This is a result of natural expansion and contraction of the genuine hardwoods used in the manufacturing of this product. Hairline cracks are not considered a defect in the cabinetry or finish and will not be considered a reason for product replacement.

When painted finishes are ordered on Benton, Korbett, Landen, Wentworth, and Winstead the door center panel will be constructed of Medium Density Fiberboard (MDF). MDF provides a smoother finish when painted and is more resistant to warping, expansion, and contraction.

Characteristics of Laminates

Thermofoil

- ▶ Doors & drawer fronts are shaped MDF core covered with a seamless vinyl laminate on face & edges, and a melamine laminate on back
- ▶ Vinyl laminate is applied to MDF with an adhesive using heat & pressure
- ▶ Creates a product with excellent wear and heat resistance properties

PureStyle™

- ▶ Durable, laminate-based material that provides superior abrasion resistance
- ▶ Meets/exceeds all KCMA performance standards
- ▶ Wrapped door rails and panels
- ▶ Clear, pre-impregnated top coat for superior durability (glazed styles have an oven-cured top coat)
- ▶ Lineals and core panel material are made of MDF to ensure a consistent and stable product
- ▶ PureStyle™ doors can be distinguished from painted cabinets by their picture-perfect distribution of satin, smooth color

These doors offer the durability of a laminate and the beauty of paint, while bringing peace of mind to those who care about creating a better environment - both inside and outside of their homes. Molded decorative door profile with a durable, yet attractive finish offers care-free maintenance. In addition to a uniform appearance, cabinets will have:

- ▶ A sleek surface
- ▶ A design that replicates a painted finish with optimum durability
- ▶ A fresh, contemporary feel that is also at home in a more traditional setting

PureStyle™ trim items will feature a matching painted finish, except where noted in product specifications.

Humidification

Cabinet components are typically manufactured at a target range of 40%–50% relative humidity. This works well because even unhumidified homes stay between 20% and 70% in normal years with typical cooking and washing activities.

In extremely cold, dry winters some doors can be exposed to conditions where relative humidity is below 20% for weeks at a time, causing shrinkage to occur. Conversely, where in-home relative humidity exceeds 70% for extended periods of time, expansion could occur. In certain geographic locations of the country, it is natural for the humidity to reach and remain at 80% for several weeks during the new construction period. Exposure to sustained conditions such as these could cause opening of the joints, and will not be considered as a reason for product replacement.

Aristokraft recommends product be stored and installed in an atmosphere where the humidity level and temperature are controlled.

Humidification Effects on a Door with a Miter Joint

High Humidity

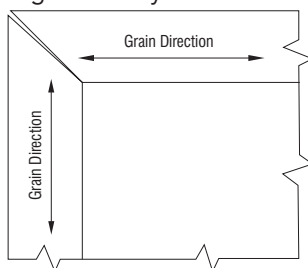

When wood swells, miter joints open as shown above.

Low Humidity

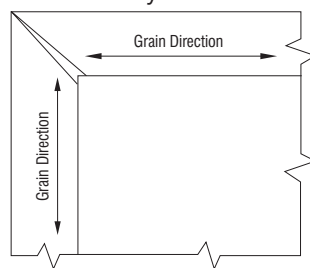

When wood shrinks, miter joints open as shown above.

Steps Consumers Can Take To Protect Real Wood Furnishings

- **Keep an eye on the humidity inside the home.** Reasonably accurate digital thermometers-hygrometer units are available to measure humidity.
- **Maintain the humidity at or above 20% when the temperature is below 20 degrees and over 35% when the temperature is above 20 degrees.** Some ways this may be accomplished are installing a whole-house humidifier on the furnace, running a portable humidifier in key rooms, or placing pans of water near the heat registers.
- **Don't over do it.** Significant condensation on windows is a sign the humidity levels are too high for outside temperature conditions.
- **Recognize that finished wood responds to humidity over a period of several days to several weeks.** It takes time before the wood returns to normal after any correction to the environment.

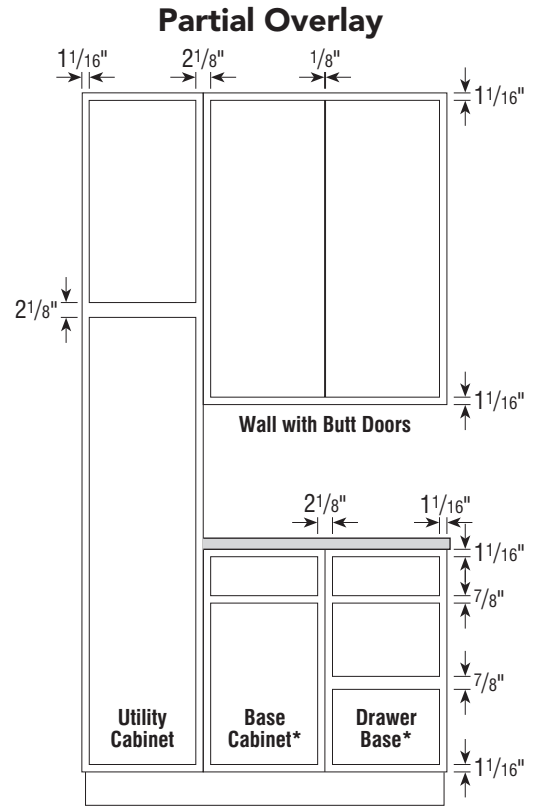
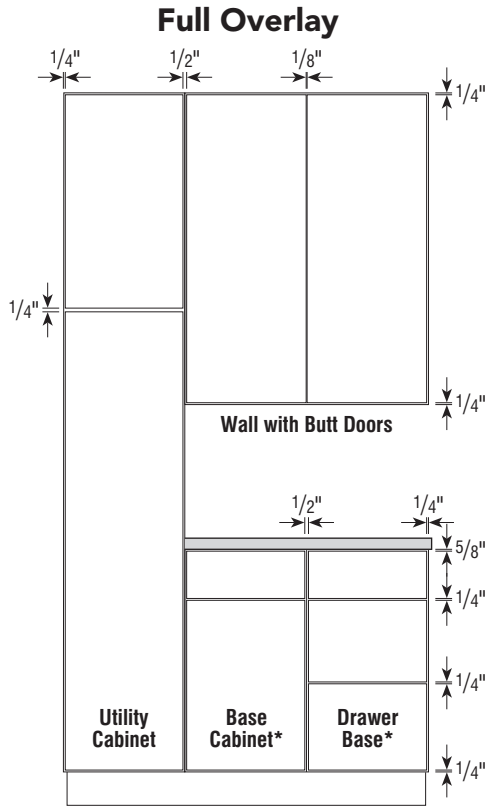

*35" high application shown
 One double door center stile cabinet has the same reveal as two single door cabinets.

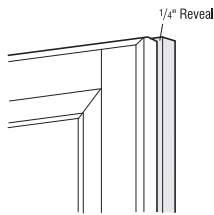

Full Overlay

► Full overlay doors reveal 1/4" of the cabinet face frame.

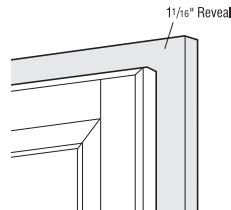

Partial Overlay 7/16"

► Partial overlay doors reveal 1 1/16" of the cabinet face frame.

Full Overlay Door Styles

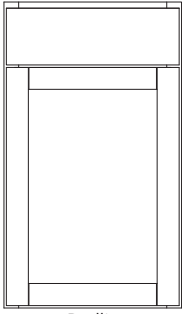

Brellin
(page 12)

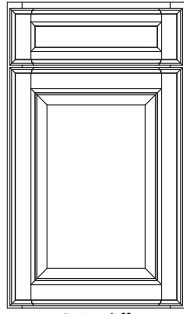

Briarcliff
(Also available in Arch)
(page 12)

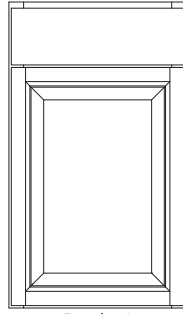

Dryden*
(page 13)

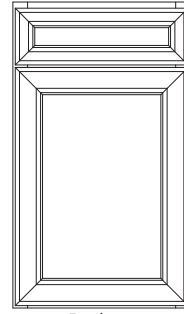

Durham
(page 13)

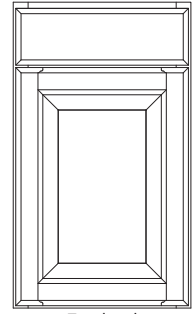

Eastland
(page 13)

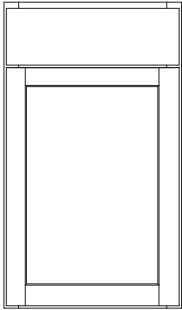

Harrison*
(page 14)

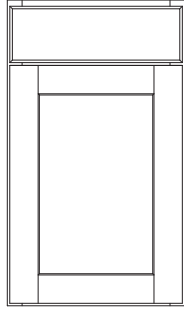

Korbett*
(page 14)

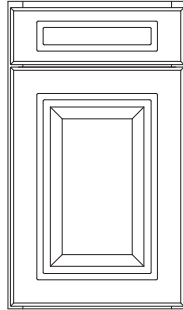

Nantucket
(page 15)

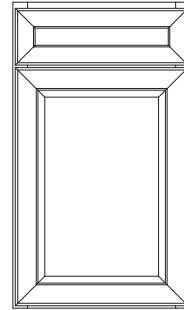

Overton
(page 16)

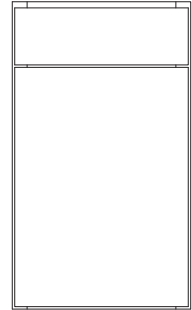

Teagan
(page 17)

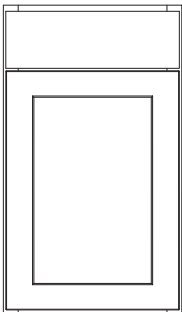

VanWyke
(page 18)

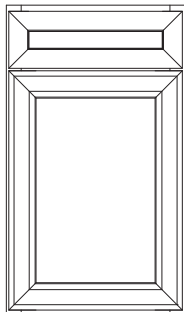

Wentworth
(page 18)

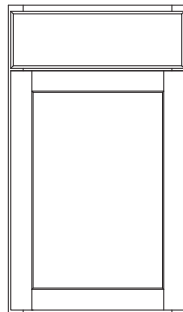

Winstead*
(page 19)



*Available with 5-Piece Drawer Fronts

Partial Overlay Door Styles

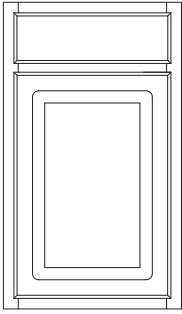

Augusta
(page 11)
CORE

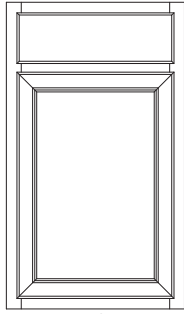

Avalon
(page 11)
CORE

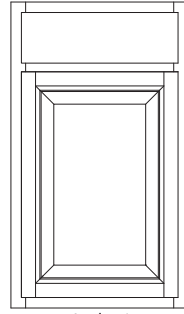

Ayden*
(page 11)
PLUS

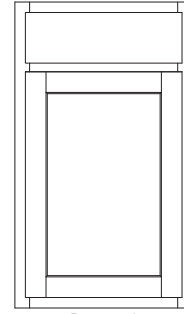

Benton*
(page 12)
PLUS

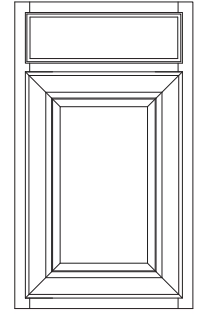

Grayson*
(page 14)
PLUS

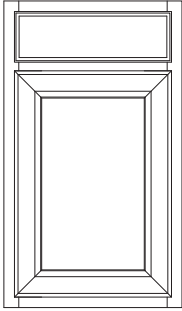

Landen*
(page 15)
PLUS

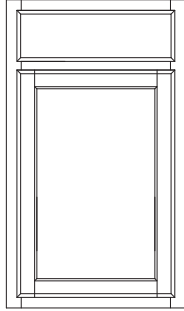

Oakland
(page 15)
CORE

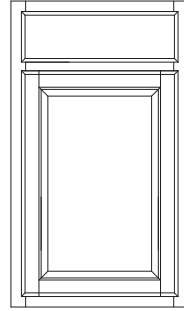

Pioneer
(page 16)
CORE

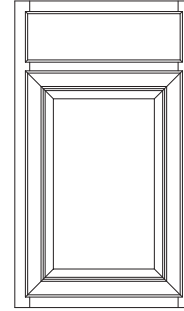

Radford*
(page 16)
PLUS

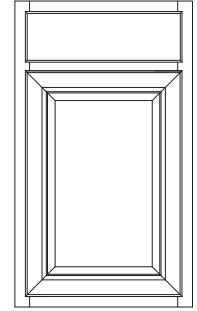

Saybrooke*
(page 17)
PLUS

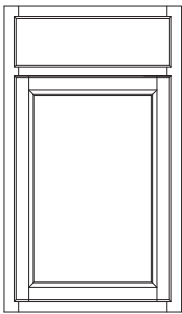

Sinclair
(page 17)
CORE

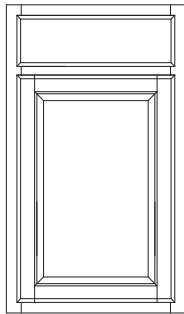

Westbury
(page 18)
CORE

*Available with 5-Piece Drawer Fronts

DOOR STYLES

Augusta

Partial Overlay

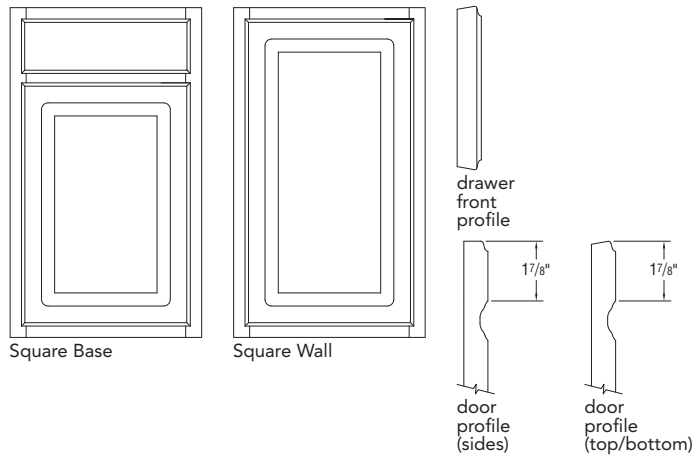

SPECIE & FINISH AVAILABILITY	
Thermofoil	Standard Finish

- ▶ Raised Panel Profile
- ▶ 3/4" Thick Door
- ▶ Reverse Bevel Profile, No Hardware Required



Note: Thermofoil will not withstand sustained temperatures in excess of 170°F. A 3" filler or heat shield is required between any thermofoil surface and any heat source to be in compliance with cabinet warranty.

Avalon

Partial Overlay

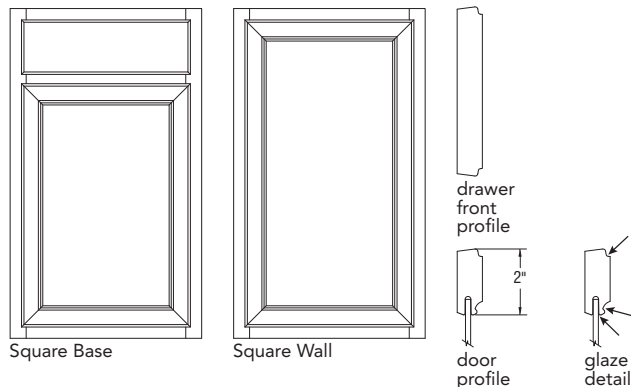

SPECIE & FINISH AVAILABILITY	
Cherry	Standard Finish
	Glaze
Maple	Standard Finish
	Glaze

- ▶ Flat Veneer Center Panel
- ▶ 3/4" Thick Solid Door Rail
- ▶ Miter Construction
- ▶ Reverse Bevel Profile, No Hardware Required



Ayden

Partial Overlay

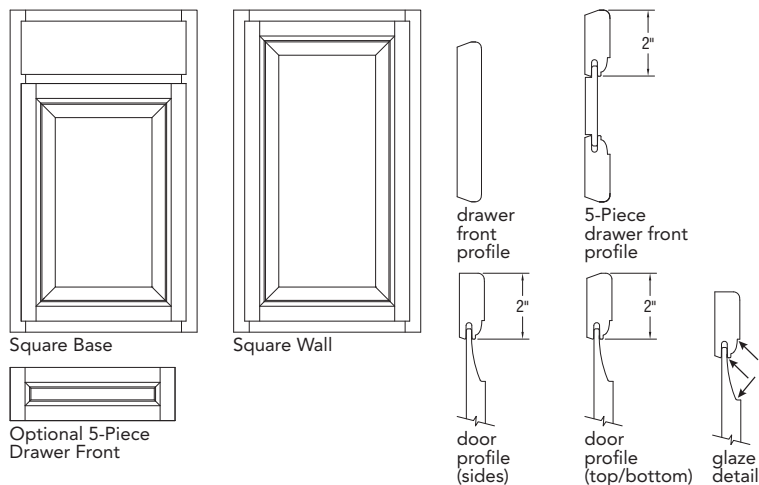

SPECIE & FINISH AVAILABILITY	
Rustic Birch	Standard Finish
	Glaze

- ▶ Raised Solid Center Panel
- ▶ 3/4" Thick Solid Door Rail
- ▶ On 5-Piece Drawer Front with Recessed Center Panel, Drawer Fronts 11 5/8" and Higher will have a Raised Veneer Center Panel with Vertical Grain.
- ▶ Hardware Recommended
- ▶ Rustic Characteristics on Door and Drawer Fronts only
- ▶ Selected Rustic Trim Items Available. Use Common Styles for Maple Finishes When Not Available. See page 178.



Glazed edges indicated by arrows on side view drawings.

DOOR STYLES

Benton

Partial Overlay

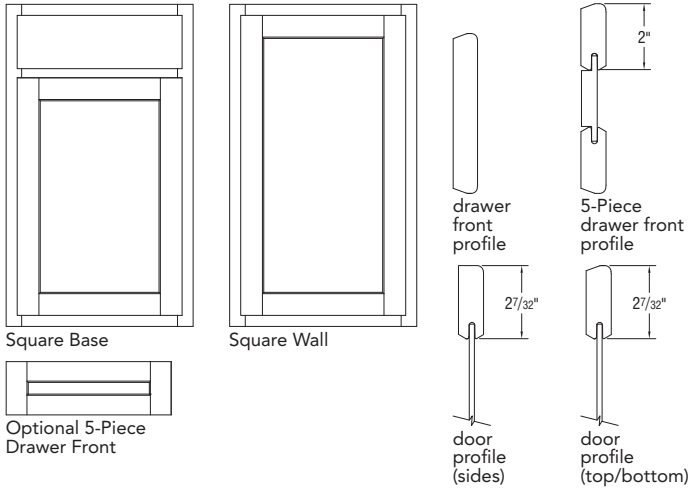

SPECIE & FINISH AVAILABILITY

Birch	Standard Finish
	Paint

- ▶ Flat Veneer Center Panel
- ▶ 3/4" Thick Solid Door Rail
- ▶ Birch Styles Use Maple Accessories
- ▶ Reverse Bevel Profile, No Hardware Required
- ▶ When paint is ordered, the door center panel will be constructed of Medium Density Fiberboard (MDF). MDF provides a smoother finish when painted and is more resistant to warping, expansion and contraction.



Brellin *New*

Full Overlay

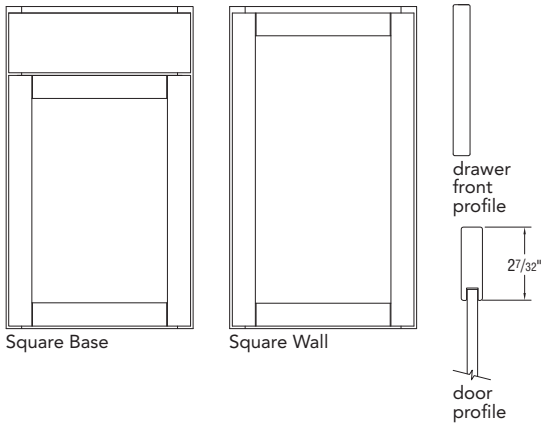

SPECIE & FINISH AVAILABILITY

PureStyle™	Standard Finish
------------	-----------------

- ▶ Flat Laminate Center Panel
- ▶ 5/8" Thick Door
- ▶ 6-Way Adjustable Hinges
- ▶ Hardware Recommended



Briarcliff II

Full Overlay

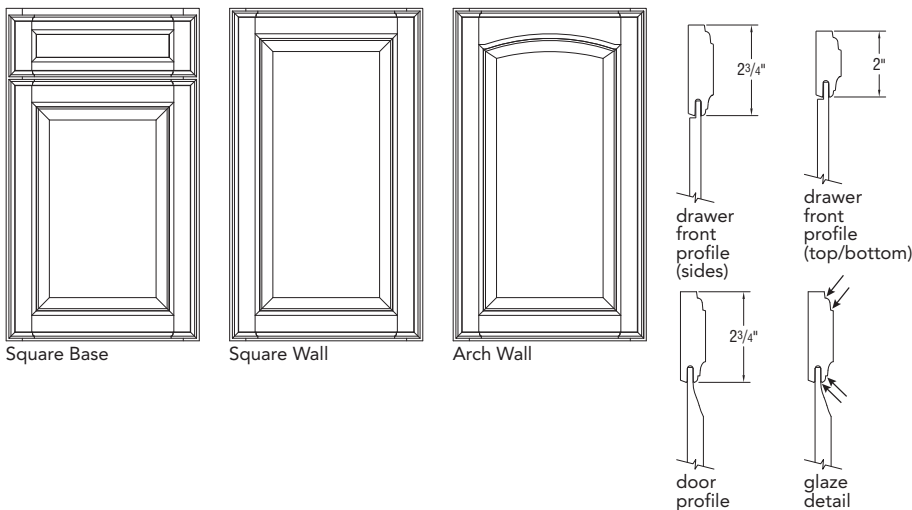

SPECIE & FINISH AVAILABILITY

Cherry	Standard Finish
	Glaze
Maple	Standard Finish
	Glaze
	Paint

- ▶ Raised Veneer Center Panel
- ▶ 3/4" Thick Solid Door Rail
- ▶ On 5-Piece Drawer Front with Recessed Center Panel, Drawer Fronts 11 7/8" and Higher will have a Raised Veneer Center Panel with Vertical Grain.
- ▶ Hardware Recommended
- ▶ Square Doors on Base Cabinets
- ▶ Arch Available in Maple Only
- ▶ Arch only available on Wall Cabinets



Glazed edges indicated by arrows on side view drawings.

DOOR STYLES

Dryden

Full Overlay

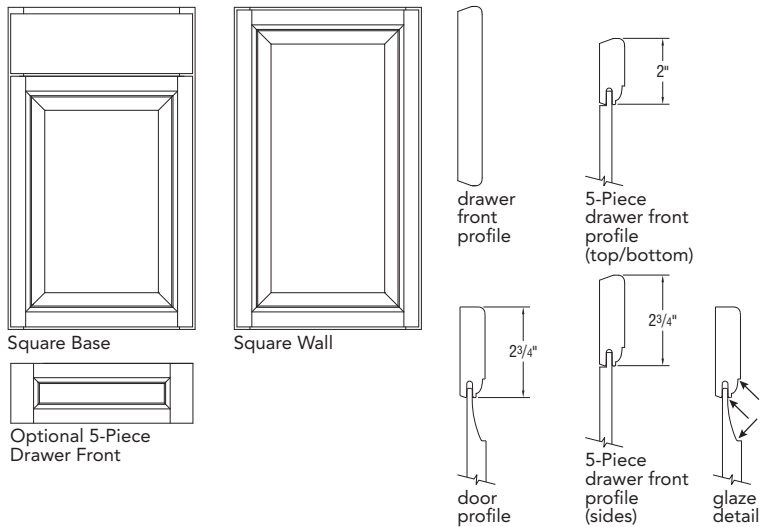

SPECIE & FINISH AVAILABILITY	
Rustic Birch	Standard Finish
	Glaze

- ▶ Raised Solid Center Panel
- ▶ 3/4" Thick Solid Door Rail
- ▶ On 5-Piece Drawer Front with Recessed Center Panel, Drawer Fronts 11 5/8" and Higher will have a Raised Veneer Center Panel with Vertical Grain.
- ▶ Hardware Recommended
- ▶ Rustic Characteristics on Door and Drawer Fronts only
- ▶ Selected Rustic Trim Items Available. Use Common Styles for Maple Finishes When Not Available. See page 178.



Durham

Full Overlay

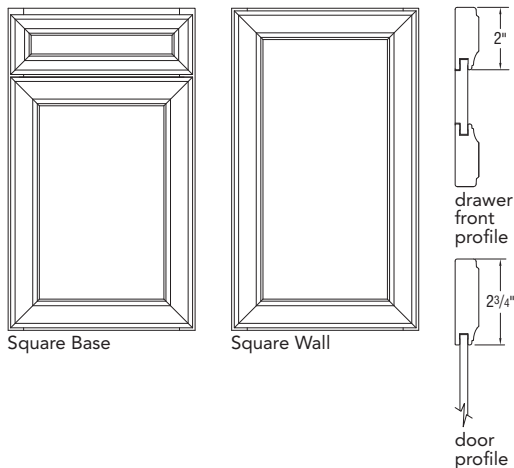

SPECIE & FINISH AVAILABILITY	
PureStyle™	Standard Finish

- ▶ 3/4" Thick Door Rail
- ▶ Miter Construction
- ▶ Flat Laminate Center Panel
- ▶ 5-Piece Miter Drawer Front
- ▶ Toasted Antique Glaze Available on Selected Trim Items. See page 178.
- ▶ Hardware Recommended



Eastland

Full Overlay

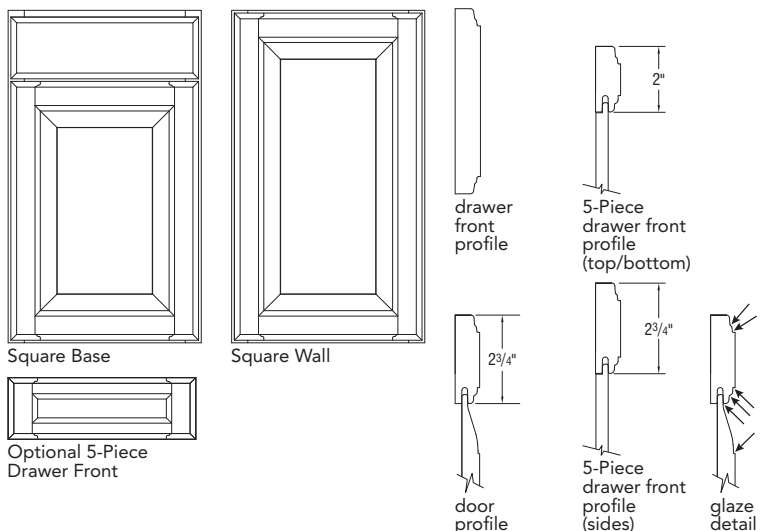

SPECIE & FINISH AVAILABILITY	
Maple	Standard Finish
	Glaze
	Paint

- ▶ Raised Solid Center Panel
- ▶ 3/4" Thick Solid Door Rail
- ▶ On 5-Piece Drawer Front with Recessed Center Panel, Drawer Fronts 11 5/8" and Higher will have a Raised Veneer Center Panel with Vertical Grain.
- ▶ Square Doors on Base Cabinets
- ▶ Hardware Recommended
- ▶ Arch only available on Wall Cabinets



Glazed edges indicated by arrows on side view drawings.

DOOR STYLES

Grayson

Partial Overlay

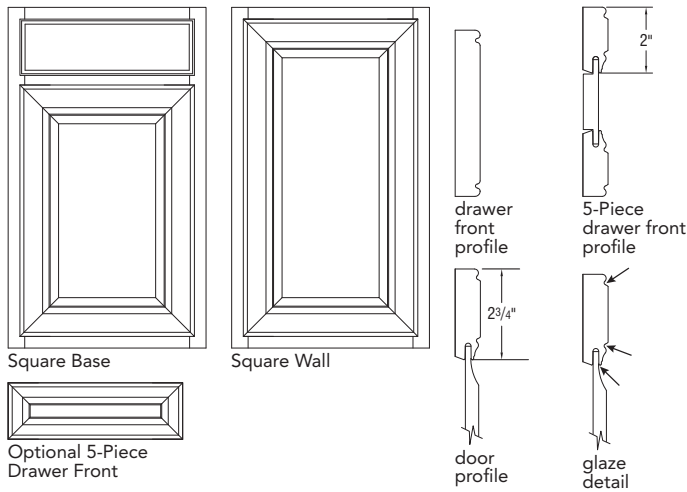

SPECIE & FINISH AVAILABILITY	
Maple	Standard Finish
	Glaze

- ▶ Raised Veneer Center Panel
- ▶ 3/4" Thick Solid Door Rail
- ▶ On 5-Piece Drawer Front with Recessed Center Panel, Drawer Fronts 11 7/8" and Higher will have a Raised Veneer Center Panel with Vertical Grain.
- ▶ Miter Construction
- ▶ Hardware Recommended



Harrison

Full Overlay

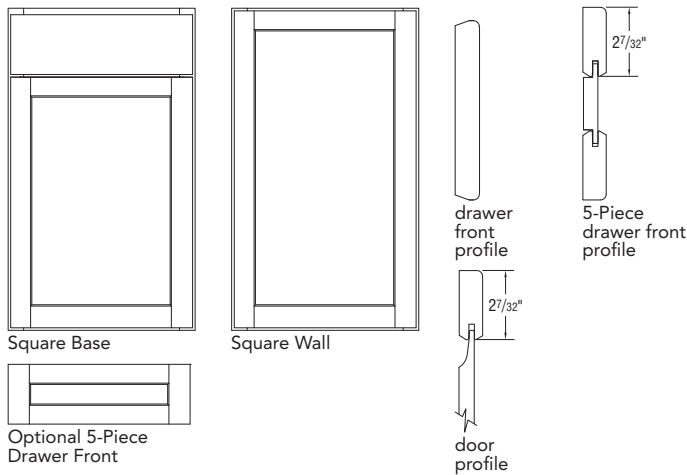

SPECIE & FINISH AVAILABILITY	
Rustic Birch	Standard Finish

- ▶ Reversed Raised Solid Center Panel
- ▶ 3/4" Thick Solid Door Rail
- ▶ Hardware Recommended
- ▶ Rustic Characteristics on Door and Drawer Fronts only
- ▶ Selected Rustic Trim Items Available. Use Common Styles for Maple Finishes When Not Available. See page 178.



Korbett

Full Overlay

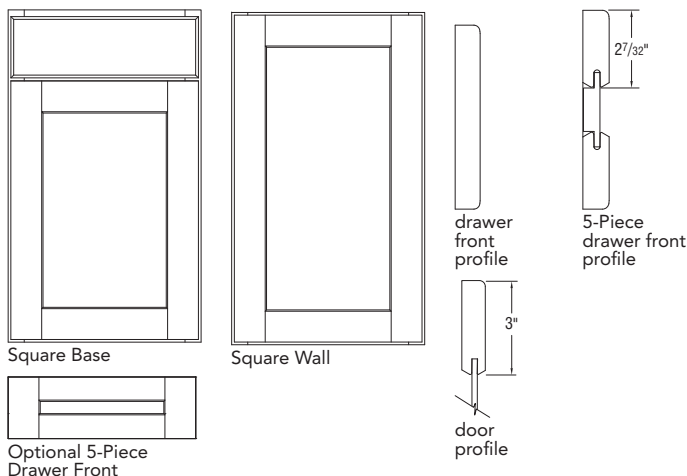

SPECIE & FINISH AVAILABILITY	
Cherry	Standard Finish
Maple	Standard Finish
	Paint

- ▶ Flat Veneer Center Panel
- ▶ 3" Wide Stile and Rail Shaker
- ▶ When paint is ordered, the door center panel will be constructed of Medium Density Fiberboard (MDF). MDF provides a smoother finish when painted and is more resistant to warping, expansion and contraction.
- ▶ Standard Butt Door



Glazed edges indicated by arrows on side view drawings.

DOOR STYLES

Landen

Partial Overlay

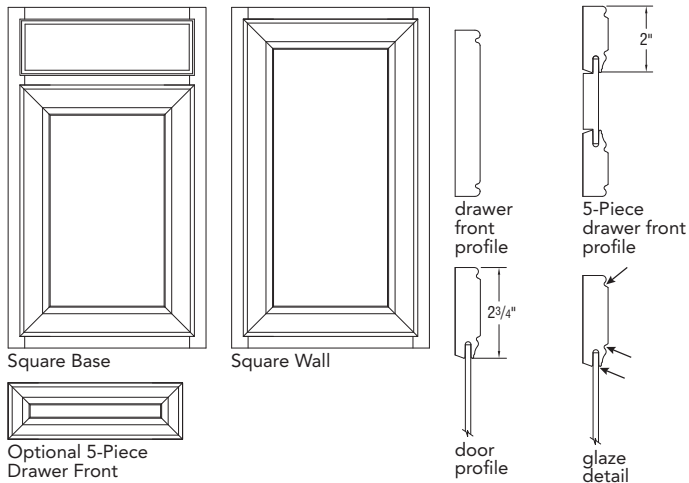

SPECIE & FINISH AVAILABILITY	
Maple	Standard Finish
	Glaze
	Paint

- ▶ Flat Veneer Center Panel
- ▶ 3/4" Thick Solid Door Rail
- ▶ Miter Construction
- ▶ Hardware Recommended
- ▶ When paint is ordered, the door center panel will be constructed of Medium Density Fiberboard (MDF). MDF provides a smoother finish when painted and is more resistant to warping, expansion and contraction.



Nantucket

Full Overlay

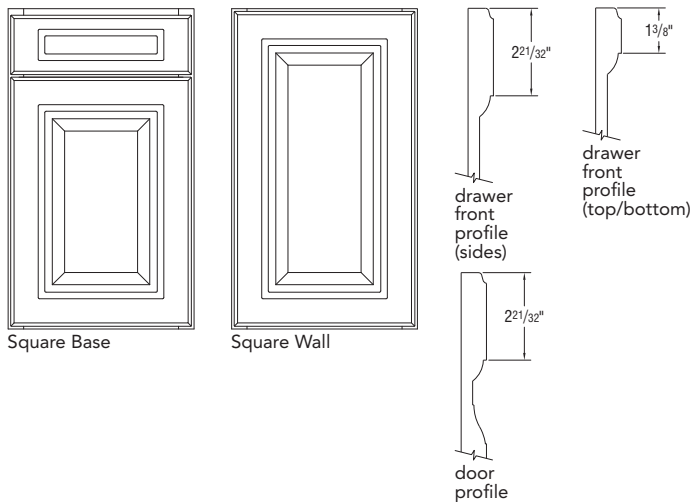

SPECIE & FINISH AVAILABILITY	
Thermofoil	Standard Finish

- ▶ Raised Panel Profile
- ▶ 3/4" Thick Door
- ▶ Satin Thermofoil
- ▶ On 5-Piece Drawer Front with Recessed Center Panel, Drawer Fronts 11 5/8" and Higher will have a Raised Veneer Center Panel.
- ▶ 5-Piece Drawer Front
- ▶ Hardware Recommended



Note: Thermofoil will not withstand sustained temperatures in excess of 170°F. A 3" filler or heat shield is required between any thermofoil surface and any heat source to be in compliance with cabinet warranty.

Oakland

Partial Overlay

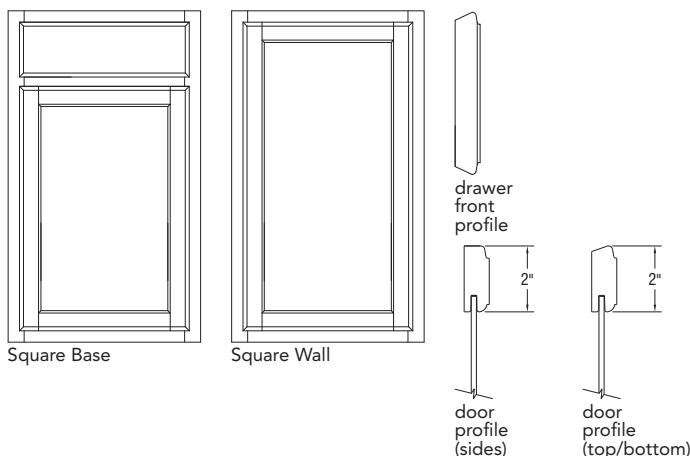

SPECIE & FINISH AVAILABILITY	
Oak	Standard Finish

- ▶ Flat Veneer Center Panel
- ▶ 3/4" Thick Solid Door Rail
- ▶ Reverse Bevel Profile, No Hardware Required



Glazed edges indicated by arrows on side view drawings.

DOOR STYLES

Overton

Full Overlay

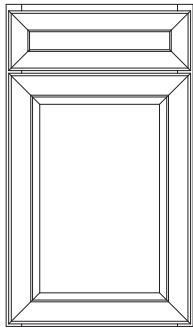

Square Base

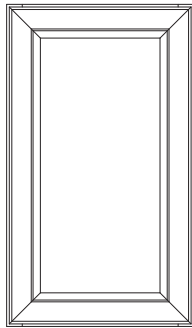

Square Wall

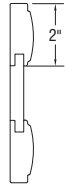

drawer front profile

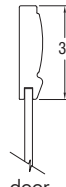

door profile

SPECIE & FINISH AVAILABILITY

PureStyle™	Standard Finish
------------	-----------------

- ▶ 3/4" Thick Door Rail
- ▶ Miter Construction
- ▶ Flat Laminate Center Panel
- ▶ 5-Piece Miter Drawer Front
- ▶ Toasted Antique Glaze Only Available on Selected Trim Items. See page 178.
- ▶ Hardware Recommended



Pioneer

Partial Overlay

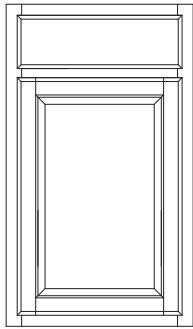

Square Base

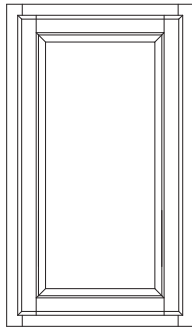

Square Wall

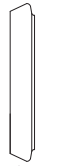

drawer front profile

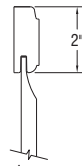

door profile (sides)

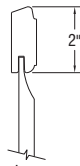

door profile (top/bottom)

SPECIE & FINISH AVAILABILITY

Hickory	Standard Finish
---------	-----------------

- ▶ Raised Veneer Center Panel
- ▶ 3/4" Thick Solid Door Rail
- ▶ Reverse Bevel Profile, No Hardware Required



Radford

Partial Overlay

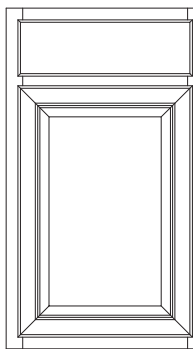

Square Base

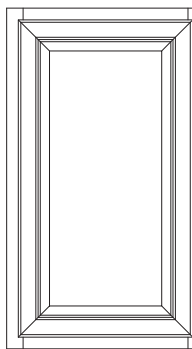

Square Wall



drawer front profile

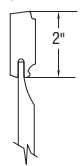

door profile

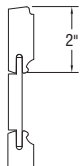

5-Piece drawer front profile

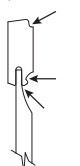

glaze detail



Optional 5-Piece Drawer Front

SPECIE & FINISH AVAILABILITY

Maple	Standard Finish
	Glaze

- ▶ Raised Veneer Center Panel
- ▶ 3/4" Thick Solid Door Rail
- ▶ On 5-Piece Drawer Front with Recessed Center Panel, Drawer Fronts 11 5/8" and Higher will have a Raised Veneer Center Panel with Vertical Grain.
- ▶ Miter Construction
- ▶ Reverse Bevel Profile, No Hardware Required



DOOR STYLES

Saybrooke

Partial Overlay

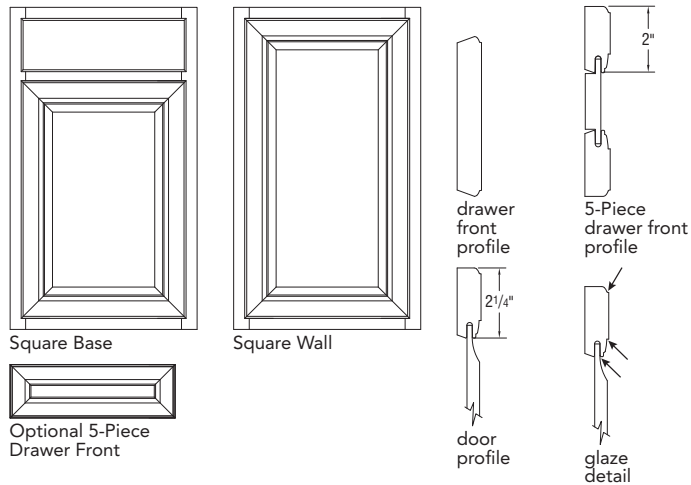

SPECIE & FINISH AVAILABILITY	
Birch	Standard Finish
	Glaze

- ▶ Raised Veneer Center Panel
- ▶ 3/4" Thick Solid Door Rail
- ▶ On 5-Piece Drawer Front with Recessed Center Panel, Drawer Fronts 11 5/8" and Higher will have a Raised Veneer Center Panel with Vertical Grain.
- ▶ Miter Construction
- ▶ Birch Styles Use Maple Accessories
- ▶ Hardware Recommended



Sinclair

Partial Overlay

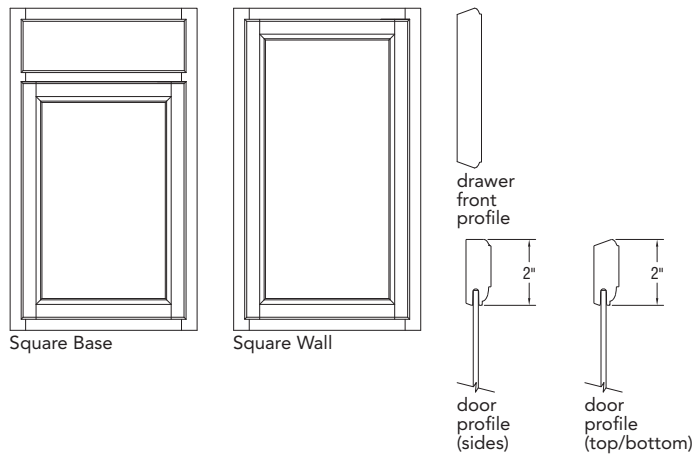

SPECIE & FINISH AVAILABILITY	
Birch	Standard Finish

- ▶ Flat Veneer Center Panel
- ▶ 3/4" Thick Solid Door Rail
- ▶ Birch Styles Use Maple Accessories
- ▶ Reverse Bevel Profile, No Hardware Required



Teagan

Full Overlay

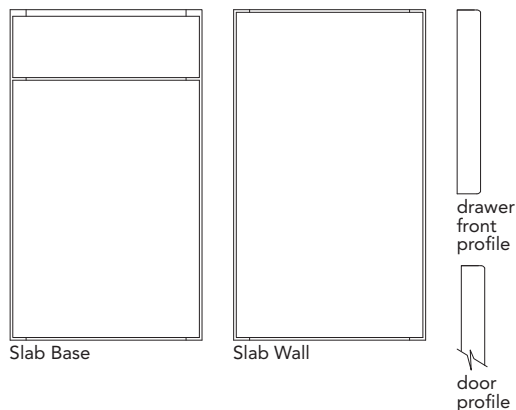

SPECIE & FINISH AVAILABILITY	
Maple	Standard Finish
	Paint

- ▶ Veneer Slab Door
- ▶ Veneer Face and Back with Furniture Board Core
- ▶ 3mm Wood Edging on all Edges
- ▶ Hardware Recommended



Glazed edges indicated by arrows on side view drawings.

DOOR STYLES

VanWyke

Full Overlay

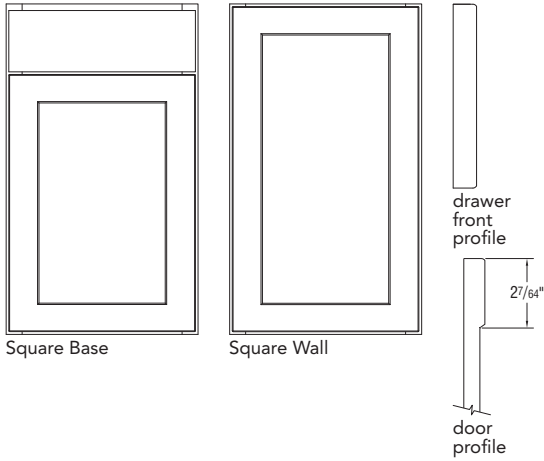

SPECIE & FINISH AVAILABILITY	
Thermofoil	Standard Finish

- ▶ Recessed Panel Profile
- ▶ 5/8" Thick Door
- ▶ 6-way Adjustable Hinges
- ▶ Hardware Recommended



Wentworth

Full Overlay

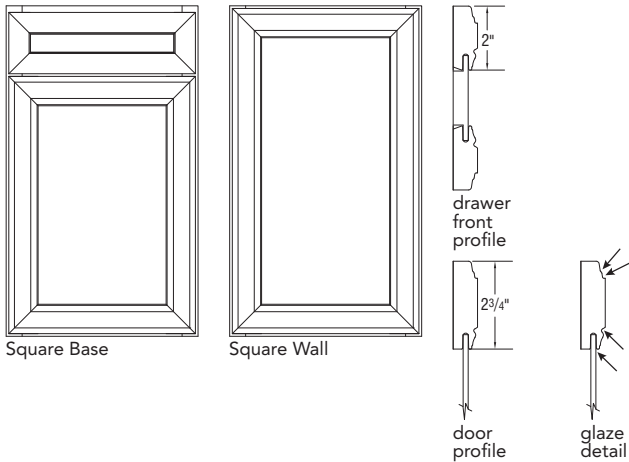

SPECIE & FINISH AVAILABILITY	
Maple	Standard Finish
	Glaze
	Paint

- ▶ Flat Veneer Center Panel
- ▶ 3/4" Thick Solid Door Rail
- ▶ Miter Construction
- ▶ 5-Piece Miter Drawer Front
- ▶ Hardware Recommended
- ▶ When paint is ordered, the door center panel will be constructed of Medium Density Fiberboard (MDF). MDF provides a smoother finish when painted and is more resistant to warping, expansion and contraction.



Westbury

Partial Overlay

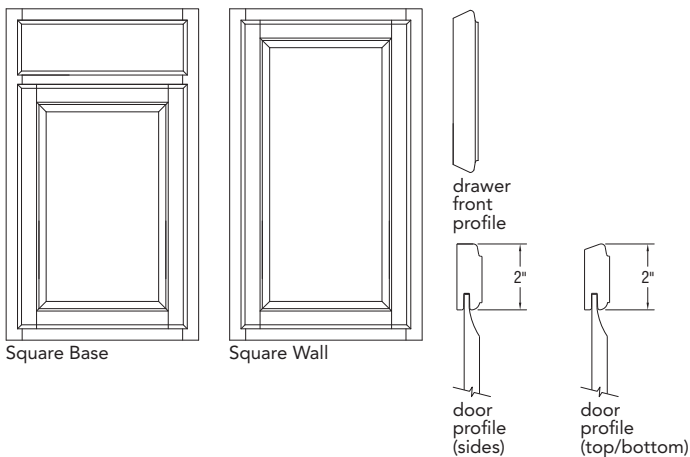

SPECIE & FINISH AVAILABILITY	
Oak	Standard Finish

- ▶ Raised Veneer Center Panel
- ▶ 3/4" Thick Solid Door Rail
- ▶ Reverse Bevel Profile, No Hardware Required



DOOR STYLES

Winstead

Full Overlay

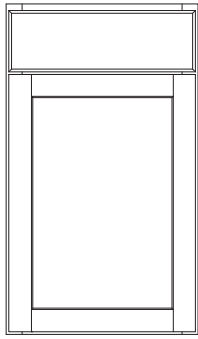

Square Base

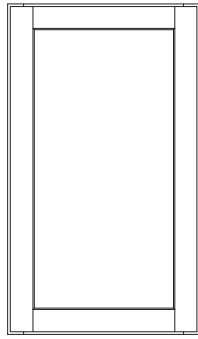

Square Wall



drawer front profile

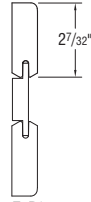

5-Piece drawer front profile



door profile

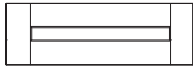

Optional 5-Piece Drawer Front

SPECIE & FINISH AVAILABILITY

Maple	Standard Finish
	Paint

- ▶ Flat Veneer Center Panel
- ▶ 3/4" Thick Solid Door Rail
- ▶ Hardware Recommended
- ▶ When paint is ordered, the door center panel will be constructed of Medium Density Fiberboard (MDF). MDF provides a smoother finish when painted and is more resistant to warping, expansion and contraction.



Finish Descriptions

	FINISH NAME	DESCRIPTION
Stain/Glaze*	Autumn	Mid-tone stain with warm, copper tones
	Café	Dark brown stain with red undertones
	Fawn	Light, warm stain, slightly darker than natural wood
	Flagstone	Dark, gray stain with brown undertones
	Java Glaze	Red toned base stain, highlighted by a dark brown glaze
	Natural	Natural finish is achieved with a clear coat which allows the pure beauty of natural woodgrain to show.
	Pumpnickel Glaze	Warm medium brown stain highlighted by a dark brown glaze
	Rouge	Traditional, cinnamon red tones
	Saddle	Medium, warm brown stain
	Sarsaparilla	Rich, deep brown stain
	Umber	Medium to dark brown stain
	Wheat	Light stain with golden undertones
Paint**/PureStyle™	Antique Paint	Warm, off-white color
	Glacier Gray	Cool, light gray color
	Toasted Antique	Warm, off-white finish enhanced by the appearance of a medium brown glaze
	White	A pure white color

*Aristokraft's Hand-Contoured Glazing is an additional step in the finishing process that highlights door detail and enhances the richness of wood color and tone. Because glazing is achieved by hand, variations will occur throughout any door, and from one door to the next. The outcome will range from a consistent, even appearance to more varied coverage. The variation is a desirable feature and brings out the uniqueness of glazing.

**On wood products, normal movement is typical due to change in climatic conditions. This will cause hairline cracks at stile, rail and panel joints. This hairline cracking is a normal characteristic of painted finishes and will not be considered a reason for product replacement.

Finishing Process

Aristokraft offers a variety of cabinet construction and finish options in order to allow for maximum design flexibility. Below are details about wood characteristics to assist you in deciding on a wood type and finish.

The Aristokraft finishing process starts with top quality lumber that is sanded down to reach difficult areas before the doors are assembled. After assembly, each door is inspected before a toner is applied with a spray. After applying toner to each door, drawer front, and face frame, a layer of stain is added using a spray finish which is then hand rubbed into the wood for maximum penetration and long-lasting beauty. A UV sealer is then applied during the finishing process to fill the grain. Finally, a UV topcoat is applied onto the door, providing a protective layer and beautiful, lasting finish. A final inspection is given at the end of the process to ensure each door is ready for cabinet assembly.

The finish you select for your door style is just as important as the wood type. Each piece of wood will react differently to the finish material used, resulting in a slight variation in shade within and between cabinets. When natural, light, or tinted finishes are applied, the natural grain characteristics are apparent. For easy care and lasting beauty, Aristokraft covers interior surfaces of cabinet walls, backs, and shelves with Aristex™ surface, a urethane-coated laminate.

		STANDARD FINISH										GLAZE		LAMINATE			PAINT	
		Autumn	Café	Fawn	Flagstone	Natural	Rouge	Saddle	Sarsaparilla	Umber	Wheat†	Java Glaze	Pumpnickel Glaze	Glacier Gray <i>New</i>	Toasted Antique	White*	Antique Paint	White Paint*
Birch																		
	Sinclair	✓	✓	✓			✓	✓	✓	✓								
	Benton	✓	✓	✓	✓		✓	✓	✓	✓						✓	✓	
	Saybrooke	✓	✓	✓	✓		✓	✓	✓	✓	✓	✓						
Cherry																		
	Avalon		✓				✓	✓		✓	✓							
	Briarcliff II		✓		✓		✓	✓		✓	✓							
	Korbett		✓		✓		✓	✓		✓	✓							
Hickory																		
	Pioneer					✓		✓		✓								
Maple																		
	Avalon	✓	✓	✓		✓	✓	✓	✓	✓	✓	✓						
	Briarcliff II	✓	✓	✓	✓	✓	✓	✓	✓	✓	✓	✓				✓	✓	
	Eastland	✓	✓	✓	✓	✓	✓	✓	✓	✓	✓	✓				✓	✓	
	Grayson	✓	✓	✓	✓	✓	✓	✓	✓	✓	✓	✓						
	Korbett	✓	✓	✓	✓	✓	✓	✓	✓	✓	✓	✓				✓	✓	
	Landen	✓	✓	✓	✓	✓	✓	✓	✓	✓	✓	✓				✓	✓	
	Radford	✓	✓	✓	✓	✓	✓	✓	✓	✓	✓	✓						
	Teagan	✓	✓	✓	✓	✓	✓	✓	✓	✓	✓	✓				✓	✓	
	Wentworth	✓	✓	✓	✓	✓	✓	✓	✓	✓	✓	✓				✓	✓	
	Winstead	✓	✓	✓	✓	✓	✓	✓	✓	✓	✓	✓				✓	✓	
Oak																		
	Oakland					✓		✓	✓	✓	✓							
	Westbury					✓		✓	✓	✓	✓							
Rustic Birch																		
	Ayden	✓	✓	✓	✓		✓	✓		✓		✓	✓					
	Dryden	✓	✓	✓	✓		✓	✓		✓		✓	✓					
	Harrison	✓	✓	✓	✓		✓	✓		✓								
PureStyle™																		
	Brellin <i>New</i>												✓		✓			
	Durham												✓	✓	✓			
	Overton													✓				
Thermofoil																		
	Augusta															✓		
	VanWyke															✓		
	Nantucket															✓		

See the following pages for door style codes by specie/finish.

† The laminate used on Cherry Wheat cabinets is matched to aged Cherry Wheat.

* White styles will have all white interior components.

How to Use Door Style Numbers

Each door style described in this catalog is available in three construction methods - Standard, Select, and APC. Depending on what finish color is being specified, each one will have its own unique style number.

- Examples:**
- ▶ Benton Sarsparilla Standard = 244
 - ▶ Benton Sarsparilla Select = 844
 - ▶ Benton Sarsparilla APC = 644
 - ▶ Benton Sarsparilla Standard 5-Piece = 5CH
 - ▶ Benton Sarsparilla Select 5-Piece = 9CH
 - ▶ Benton Sarsparilla APC 5-Piece = 7CH

STYLE/COLOR	STD	SEL	APC	STD/5PC	SEL/5PC	APC/5PC	COMMON STYLE
Augusta Thermofoil White	205	805	605	-	-	-	184
Avalon Cherry Café	59T	99T	79T	-	-	-	159
Avalon Cherry Java Glaze	59N	99N	79N	-	-	-	169
Avalon Cherry Pumpernickel Glaze	59U	99U	79U	-	-	-	192
Avalon Cherry Rouge	59E	99E	79E	-	-	-	174
Avalon Cherry Saddle	59M	99M	79M	-	-	-	173
Avalon Cherry Umber	59D	99D	79D	-	-	-	156
Avalon Cherry Wheat	59B	99B	79B	-	-	-	176
Avalon Maple Autumn	55F	95F	75F	-	-	-	183
Avalon Maple Café	55T	95T	75T	-	-	-	167
Avalon Maple Fawn	55G	95G	75G	-	-	-	197
Avalon Maple Java Glaze	55N	95N	75N	-	-	-	168
Avalon Maple Natural	55C	95C	75C	-	-	-	182
Avalon Maple Pumpernickel Glaze	55U	95U	75U	-	-	-	191
Avalon Maple Rouge	55E	95E	75E	-	-	-	180
Avalon Maple Saddle	55M	95M	75M	-	-	-	170
Avalon Maple Sarsaparilla	55W	95W	75W	-	-	-	193
Avalon Maple Umber	55D	95D	75D	-	-	-	157
Ayden Rustic Birch Autumn	41F	81F	61F	5BV	9BV	7BV	161
Ayden Rustic Birch Café	41T	81T	61T	5BW	9BW	7BW	154
Ayden Rustic Birch Fawn	41G	81G	61G	5BX	9BX	7BX	162
Ayden Rustic Birch Flagstone	41H	81H	61H	5JC	9JC	7JC	153
Ayden Rustic Birch Java Glaze	41N	81N	61N	5JR	9JR	7JR	178
Ayden Rustic Birch Pumpernickel Glaze	41U	81U	61U	5GK	9GK	7GK	196
Ayden Rustic Birch Rouge	41E	81E	61E	5BY	9BY	7BY	163
Ayden Rustic Birch Saddle	41M	81M	61M	5BZ	9BZ	7BZ	164
Ayden Rustic Birch Umber	41D	81D	61D	5CA	9CA	7CA	155
Brellin PureStyle™ Glacier Gray	252	852	652				194
Brellin PureStyle™ White	256	856	656				184
Benton Birch Antique	246	846	646	5CB	9CB	7CB	198
Benton Birch Autumn	240	840	640	5CC	9CC	7CC	183
Benton Birch Café	541	941	741	5CD	9CD	7CD	167
Benton Birch Fawn	241	841	641	5CE	9CE	7CE	197
Benton Birch Flagstone	248	848	648	5JD	9JD	7JD	151
Benton Birch Rouge	242	842	642	5CF	9CF	7CF	180
Benton Birch Saddle	243	843	643	5CG	9CG	7CG	170
Benton Birch Sarsaparilla	244	844	644	5CH	9CH	7CH	193
Benton Birch Umber	247	847	647	5CJ	9CJ	7CJ	157
Benton Birch White	245	845	645	5CK	9CK	7CK	184
Briarcliff II Cherry Cafe	-	-	-	5BH	9BH	7BH	159
Briarcliff II Cherry Flagstone	-	-	-	5JB	9JB	7JB	150
Briarcliff II Cherry Java Glaze	-	-	-	5BG	9BG	7BG	169
Briarcliff II Cherry Pumpernickel Glaze	-	-	-	5BS	9BS	7BS	192
Briarcliff II Cherry Rouge	-	-	-	5BD	9BD	7BD	174
Briarcliff II Cherry Saddle	-	-	-	5BF	9BF	7BF	173
Briarcliff II Cherry Umber	-	-	-	5BC	9BC	7BC	156
Briarcliff II Cherry Wheat	-	-	-	5BB	9BB	7BB	176

STYLE/COLOR	STD	SEL	APC	STD/5PC	SEL/5PC	APC/5PC	COMMON STYLE
Briarcliff II Maple Antique	-	-	-	5AM	9AM	7AM	198
Briarcliff II Maple Autumn	-	-	-	5AD	9AD	7AD	183
Briarcliff II Maple Café	-	-	-	5AJ	9AJ	7AJ	167
Briarcliff II Maple Fawn	-	-	-	5AE	9AE	7AE	197
Briarcliff II Maple Flagstone	-	-	-	5HZ	9HZ	7HZ	151
Briarcliff II Maple Java Glaze	-	-	-	5AH	9AH	7AH	168
Briarcliff II Maple Natural	-	-	-	5AA	9AA	7AA	182
Briarcliff II Maple Pumpernickel Glaze	-	-	-	5BT	9BT	7BT	191
Briarcliff II Maple Rouge	-	-	-	5AC	9AC	7AC	180
Briarcliff II Maple Saddle	-	-	-	5AG	9AG	7AG	170
Briarcliff II Maple Sarsaparilla	-	-	-	5AK	9AK	7AK	193
Briarcliff II Maple Umber	-	-	-	5AB	9AB	7AB	157
Briarcliff II Maple White	-	-	-	5AL	9AL	7AL	184
Briarcliff II Maple Arch Antique	-	-	-	5BA	9BA	7BA	198
Briarcliff II Maple Arch Autumn	-	-	-	5AS	9AS	7AS	183
Briarcliff II Maple Arch Café	-	-	-	5AX	9AX	7AX	167
Briarcliff II Maple Arch Fawn	-	-	-	5AT	9AT	7AT	197
Briarcliff II Maple Arch Flagstone	-	-	-	5JA	9JA	7JA	151
Briarcliff II Maple Arch Java Glaze	-	-	-	5AW	9AW	7AW	168
Briarcliff II Maple Arch Natural	-	-	-	5AN	9AN	7AN	182
Briarcliff II Maple Arch Pumpernickel Glaze	-	-	-	5BU	9BU	7BU	191
Briarcliff II Maple Arch Rouge	-	-	-	5AR	9AR	7AR	180
Briarcliff II Maple Arch Saddle	-	-	-	5AV	9AV	7AV	170
Briarcliff II Maple Arch Sarsaparilla	-	-	-	5AY	9AY	7AY	193
Briarcliff II Maple Arch Umber	-	-	-	5AP	9AP	7AP	157
Briarcliff II Maple Arch White	-	-	-	5AZ	9AZ	7AZ	184
Dryden Rustic Birch Autumn	47F	87F	67F	5CL	9CL	7CL	161
Dryden Rustic Birch Café	47T	87T	67T	5CM	9CM	7CM	154
Dryden Rustic Birch Fawn	47G	87G	67G	5CN	9CN	7CN	162
Dryden Rustic Birch Flagstone	47H	87H	67H	5JE	9JE	7JE	153
Dryden Rustic Birch Java Glaze	47N	87N	67N	5JS	9JS	7JS	178
Dryden Rustic Birch Pumpernickel Glaze	47U	87U	67U	5GL	9GL	7GL	196
Dryden Rustic Birch Rouge	47E	87E	67E	5CP	9CP	7CP	163
Dryden Rustic Birch Saddle	47M	87M	67M	5CR	9CR	7CR	164
Dryden Rustic Birch Umber	47D	87D	67D	5CS	9CS	7CS	155
Durham PureStyle™ Antique	-	-	-	211	811	611	199
Durham Glacier Gray	-	-	-	258	858	658	194
Durham White	-	-	-	257	857	657	184
Eastland Maple Antique	527	927	727	5CT	9CT	7CT	198
Eastland Maple Autumn	552	952	752	5CU	9CU	7CU	183
Eastland Maple Café	521	921	721	5CV	9CV	7CV	167
Eastland Maple Fawn	553	953	753	5CW	9CW	7CW	197
Eastland Maple Flagstone	262	862	662	5JF	9JF	7JF	151
Eastland Maple Java Glaze	557	957	757	5CX	9CX	7CX	168
Eastland Maple Natural	551	951	751	5CY	9CY	7CY	182
Eastland Maple Pumpernickel Glaze	554	954	754	5DA	9DA	7DA	191
Eastland Maple Rouge	550	950	750	5CZ	9CZ	7CZ	180
Eastland Maple Saddle	556	956	756	5DB	9DB	7DB	170
Eastland Maple Sarsaprilla	559	959	759	5DC	9DC	7DC	193
Eastland Maple Umber	503	903	703	5DD	9DD	7DD	157
Eastland Maple White	526	926	726	5DE	9DE	7DE	184
Grayson Maple Autumn	50F	90F	70F	5DV	9DV	7DV	183
Grayson Maple Café	50T	90T	70T	5DW	9DW	7DW	167
Grayson Maple Fawn	50G	90G	70G	5DX	9DX	7DX	197
Grayson Maple Flagstone	50H	90H	70H	5JH	9JH	7JH	151
Grayson Maple Java Glaze	50N	90N	70N	5DY	9DY	7DY	168
Grayson Maple Natural	50C	90C	70C	5DZ	9DZ	7DZ	182
Grayson Maple Pumpernickel Glaze	50U	90U	70U	5EA	9EA	7EA	191
Grayson Maple Rouge	50E	90E	70E	5EB	9EB	7EB	180
Grayson Maple Saddle	50M	90M	70M	5EC	9EC	7EC	170
Grayson Maple Sarsaprilla	50W	90W	70W	5ED	9ED	7ED	193
Grayson Maple Umber	50D	90D	70D	5EE	9EE	7EE	157

STYLE/COLOR	STD	SEL	APC	STD/5PC	SEL/5PC	APC/5PC	COMMON STYLE
Harrison Rustic Birch Autumn	46F	86F	66F	5EF	9EF	7EF	161
Harrison Rustic Birch Café	46T	86T	66T	5EG	9EG	7EG	154
Harrison Rustic Birch Fawn	46G	86G	66G	5EH	9EH	7EH	162
Harrison Rustic Birch Flagstone	46H	86H	66H	5JJ	9JJ	7JJ	153
Harrison Rustic Birch Rouge	46E	86E	66E	5EJ	9EJ	7EJ	163
Harrison Rustic Birch Saddle	46M	86M	66M	5EK	9EK	7EK	164
Harrison Rustic Birch Umber	46D	86D	66D	5EL	9EL	7EL	155
Korbett Cherry Café	5HL	9HL	7HL	5HT	9HT	7HT	159
Korbett Cherry Flagstone	5HM	9HM	7HM	5HU	9HU	7HU	150
Korbett Cherry Rouge	5HN	9HN	7HN	5HV	9HV	7HV	174
Korbett Cherry Saddle	5HP	9HP	7HP	5HW	9HW	7HW	173
Korbett Cherry Umber	5HR	9HR	7HR	5HX	9HX	7HX	156
Korbett Cherry Wheat	5HS	9HS	7HS	5HY	9HY	7HY	176
Korbett Maple Antique Paint	5GM	9GM	7GM	5GZ	9GZ	7GZ	198
Korbett Maple Autumn	5GN	9GN	7GN	5HA	9HA	7HA	183
Korbett Maple Café	5GP	9GP	7GP	5HB	9HB	7HB	167
Korbett Maple Fawn	5GR	9GR	7GR	5HC	9HC	7HC	197
Korbett Maple Flagstone	5GS	9GS	7GS	5HD	9HD	7HD	151
Korbett Maple Natural	5GT	9GT	7GT	5HE	9HE	7HE	182
Korbett Maple Rouge	5GU	9GU	7GU	5HF	9HF	7HF	180
Korbett Maple Saddle	5GV	9GV	7GV	5HG	9HG	7HG	170
Korbett Maple Sarsaparilla	5GW	9GW	7GW	5HH	9HH	7HH	193
Korbett Maple Umber	5GX	9GX	7GX	5HJ	9HJ	7HJ	157
Korbett Maple White Paint	5GY	9GY	7GY	5HK	9HK	7HK	184
Landen Maple Antique	588	988	788	5EM	9EM	7EM	198
Landen Maple Autumn	572	972	772	5EN	9EN	7EN	183
Landen Maple Café	525	925	725	5EP	9EP	7EP	167
Landen Maple Fawn	573	973	773	5ER	9ER	7ER	197
Landen Maple Flagstone	264	864	664	5JK	9JK	7JK	151
Landen Maple Java Glaze	577	977	777	5ES	9ES	7ES	168
Landen Maple Natural	571	971	771	5ET	9ET	7ET	182
Landen Maple Pumpernickel Glaze	574	974	774	5EU	9EU	7EU	191
Landen Maple Rouge	570	970	770	5EV	9EV	7EV	180
Landen Maple Saddle	576	976	776	5EW	9EW	7EW	170
Landen Maple Sarsaprilla	579	979	779	5EX	9EX	7EX	193
Landen Maple Umber	505	905	705	5EY	9EY	7EY	157
Landen Maple White	587	987	787	5EZ	9EZ	7EZ	184
Nantucket Thermofoil White	-	-	-	200	800	600	184
Oakland Oak Natural	275	875	675	-	-	-	188
Oakland Oak Saddle	253	853	653	-	-	-	171
Oakland Oak Sarsaparilla	251	851	651	-	-	-	187
Oakland Oak Umber	508	908	708	-	-	-	158
Oakland Oak Wheat	255	855	655	-	-	-	186
Overton PureStyle™ Toasted Antique	-	-	-	250	850	650	199
Pioneer Hickory Natural	290	890	690	-	-	-	190
Pioneer Hickory Saddle	293	893	693	-	-	-	172
Pioneer Hickory Wheat	292	892	692	-	-	-	177
Radford Maple Autumn	56F	96F	76F	5FF	9FF	7FF	183
Radford Maple Café	56T	96T	76T	5FG	9FG	7FG	167
Radford Maple Fawn	56G	96G	76G	5FH	9FH	7FH	197
Radford Maple Flagstone	56H	96H	76H	5JM	9JM	7JM	151
Radford Maple Java Glaze	56N	96N	76N	5FJ	9FJ	7FJ	168
Radford Maple Natural	56C	96C	76C	5FK	9FK	7FK	182
Radford Maple Pumpernickel Glaze	56U	96U	76U	5FL	9FL	7FL	191
Radford Maple Rouge	56E	96E	76E	5FM	9FM	7FM	180
Radford Maple Saddle	56M	96M	76M	5FN	9FN	7FN	170
Radford Maple Sarsaprilla	56W	96W	76W	5FP	9FP	7FP	193
Radford Maple Umber	56D	96D	76D	5FR	9FR	7FR	157

STYLE/COLOR	STD	SEL	APC	STD/5PC	SEL/5PC	APC/5PC	COMMON STYLE
Saybrooke Birch Autumn	225	825	625	5FS	9FS	7FS	183
Saybrooke Birch Café	581	981	781	5FT	9FT	7FT	167
Saybrooke Birch Fawn	226	826	626	5FU	9FU	7FU	197
Saybrooke Birch Flagstone	259	859	659	5JN	9JN	7JN	151
Saybrooke Birch Java Glaze	277	877	677	5JT	9JT	7JT	168
Saybrooke Birch Pumpernickle Glaze	278	878	678	5JU	9JU	7JU	191
Saybrooke Birch Rouge	228	828	628	5FV	9FV	7FV	180
Saybrooke Birch Saddle	227	827	627	5FW	9FW	7FW	170
Saybrooke Birch Sarsaprilla	229	829	629	5FX	9FX	7FX	193
Saybrooke Birch Umber	501	901	701	5FY	9FY	7FY	157
Sinclair Birch Autumn	220	820	620	-	-	-	183
Sinclair Birch Café	564	964	764	-	-	-	167
Sinclair Birch Fawn	221	821	621	-	-	-	197
Sinclair Birch Rouge	223	823	623	-	-	-	180
Sinclair Birch Saddle	222	822	622	-	-	-	170
Sinclair Birch Sarsaprilla	239	839	639	-	-	-	193
Sinclair Birch Umber	500	900	700	-	-	-	157
Teagan Maple Antique	58Y	98Y	78Y	-	-	-	198
Teagan Maple Autumn	58F	98F	78F	-	-	-	183
Teagan Maple Café	58T	98T	78T	-	-	-	167
Teagan Maple Fawn	58G	98G	78G	-	-	-	197
Teagan Maple Flagstone	58H	98H	78H	-	-	-	151
Teagan Maple Natural	58C	98C	78C	-	-	-	182
Teagan Maple Rouge	58E	98E	78E	-	-	-	180
Teagan Maple Saddle	58M	98M	78M	-	-	-	170
Teagan Maple Sarsaprilla	58W	98W	78W	-	-	-	193
Teagan Maple Umber	58D	98D	78D	-	-	-	157
Teagan Maple White	58X	98X	78X	-	-	-	184
VanWyke Thermofoil White	209	809	609	-	-	-	184
Wentworth Maple Antique	-	-	-	51Y	91Y	71Y	198
Wentworth Maple Autumn	-	-	-	51F	91F	71F	183
Wentworth Maple Café	-	-	-	51T	91T	71T	167
Wentworth Maple Fawn	-	-	-	51G	91G	71G	197
Wentworth Maple Flagstone	-	-	-	51H	91H	71H	151
Wentworth Maple Java Glaze	-	-	-	51N	91N	71N	168
Wentworth Maple Natural	-	-	-	51C	91C	71C	182
Wentworth Maple Pumpernickel Glaze	-	-	-	51U	91U	71U	191
Wentworth Maple Rouge	-	-	-	51E	91E	71E	180
Wentworth Maple Saddle	-	-	-	51M	91M	71M	170
Wentworth Maple Sarsaprilla	-	-	-	51W	91W	71W	193
Wentworth Maple Umber	-	-	-	51D	91D	71D	157
Wentworth Maple White	-	-	-	51X	91X	71X	184
Westbury Oak Natural	231	831	631	-	-	-	188
Westbury Oak Saddle	230	830	630	-	-	-	171
Westbury Oak Sarsaparilla	234	834	634	-	-	-	187
Westbury Oak Umber	506	906	706	-	-	-	158
Westbury Oak Wheat	236	836	636	-	-	-	186
Winstead Maple Antique	549	949	749	5FZ	9FZ	7FZ	198
Winstead Maple Autumn	543	943	743	5GA	9GA	7GA	183
Winstead Maple Café	594	994	794	5GB	9GB	7GB	167
Winstead Maple Fawn	544	944	744	5GC	9GC	7GC	197
Winstead Maple Flagstone	261	861	661	5JP	9JP	7JP	151
Winstead Maple Natural	542	942	742	5GD	9GD	7GD	182
Winstead Maple Rouge	540	940	740	5GE	9GE	7GE	180
Winstead Maple Saddle	545	945	745	5GF	9GF	7GF	170
Winstead Maple Sarsaprilla	547	947	747	5GG	9GG	7GG	193
Winstead Maple Umber	502	902	702	5GH	9GH	7GH	157
Winstead Maple White	548	948	748	5GJ	9GJ	7GJ	184

Common Style Numbers for Finishes



In addition to the style numbers for door styles, there are several common items such as mouldings, panels, valances, fillers, organizers, wood hood units, open shelf units, and other parts that have been changed to a common style number based on finish. Look for the symbol (shown left) used throughout this book indicating Common Items. Please reference these common style numbers in the chart below.

Birch Antique	198
Birch Autumn*	183
Birch Café*	167
Birch Fawn*	197
Birch Flagstone*	151
Birch Java Glaze*	168
Birch Pumpernickle Glaze*	191
Birch Rouge*	180
Birch Saddle*	170
Birch Sarsaparilla*	193
Birch Umber*	157
Benton Birch White	184
Cherry Café	159
Cherry Flagstone	150
Cherry Java Glaze	169
Cherry Pumpernickel Glaze	192
Cherry Rouge	174
Cherry Saddle	173
Cherry Umber	156
Cherry Wheat	176
Hickory Natural	190
Hickory Saddle	172
Hickory Wheat	177
Maple Autumn	183
Maple Café	167
Maple Fawn	197
Maple Flagstone	151
Maple Java Glaze	168
Maple Natural	182
Maple Pumpernickel Glaze	191
Maple Rouge	180
Maple Saddle	170
Maple Sarsaparilla	193
Maple Umber	157
Oak Flagstone	152
Oak Natural	188
Oak Saddle	171
Oak Sarsaparilla	187
Oak Umber	158
Oak Wheat	186
Rustic Birch Autumn	161
Rustic Birch Café	154
Rustic Birch Fawn	162
Rustic Birch Flagstone	153
Rustic Birch Java Glaze	178
Rustic Birch Pumpernickel Glaze	196
Rustic Birch Saddle	164
Rustic Birch Rouge	163
Rustic Birch Umber	155
Antique	198
Glacier Gray <i>New</i>	194
Toasted Antique Glaze**	199
White	184

* Use Maple for Birch common items.

** Toasted Antique Glaze common style items will feature a glaze appearance and are only available on selected trim items. All other trim items should be ordered as Antique (#198).

Note:

–Antique, Glacier Gray, and White common style items will be painted hardwood.

–Use common styles for Maple finishes when Rustic Birch is not available.

	Miscellaneous Style	010	Miscellaneous items such as Sink Tip-Out Trays, and Cutlery Trays should use Common Style #010.
---	---------------------	-----	---



CABINET CONSTRUCTION OPTIONS

CABINET CONSTRUCTION OPTIONS	STANDARD	SELECT	APC*	
	SIDES	3/8" Thick Furniture Board with Matching Laminate Exterior		3/8" Thick Plywood, Finished Veneer Exterior
	BACK	3/8" Thick Furniture Board		3/8" Thick Plywood
	TOP (Wall)	1/2" Thick Furniture Board		1/2" Thick Plywood
	BOTTOM (Wall)	1/2" Thick Furniture Board		1/2" Thick Plywood
	BOTTOM (Base)	3/8" Thick Furniture Board		3/8" Thick Plywood
	CORNERS (Base)	Four Furniture Board Braces		Two Plywood Stretcher Rails
	SHELVES (Wall and Tall)	Adjustable 3/4" Thick Full-Depth Furniture Board (15 lbs. Maximum weight per square foot)		Adjustable 3/4" Thick Plywood (15 lbs. maximum weight per sq. foot)
	SHELVES (Base)	Fixed 1/2" Thick Half-Depth Furniture Board Adjustable 3/4" Thick Full-Depth Furniture Board on Open & Full Height Base Cabinets		Fixed 1/2" Thick Half-Depth Plywood Adjustable 3/4" Thick Full-Depth Plywood on Open & Full Height Base Cabinets
	TOEKICK	3/8" Thick x 4" High Furniture Board, Recessed 3 3/8", Unfinished (Requires cover: TOEKICK/TOEKICK8)		3/8" Thick x 4" High Plywood, Recessed 3 3/8", Unfinished (Requires cover: TOEKICK/TOEKICK8/TOEKICKPLY8)
FACE FRAME	3/4" x 1 1/2" Solid Wood			
INTERIOR COMPONENTS	Aristex™ Natural Maple Laminate (White Styles feature Aristex™ White Laminate)	Aristex™ Natural Maple Laminate (White Styles feature Aristex™ White Laminate on all interior components except cabinet drawers)		
HINGES	6-Way Adjustable, Fully Concealed, Steel Hinges	6-Way Adjustable, Fully Concealed, Steel Hinges with Smart Stop™ <i>New</i>		

DRAWER CONSTRUCTION OPTIONS

DRAWER CONSTRUCTION OPTIONS	STANDARD	SELECT	APC*	
	BOX	1/2" Thick Furniture Board	3/4" ** Thick All Wood with Clear Topcoat	
	BOTTOM	3/8" Thick Furniture Board, Stapled into Sides, Front, & Back	1/4" Thick Plywood, Fully Captured	
	GUIDES	Side-Mount, Epoxy-Coated, Double Rails, Captured on Two Sides	Concealed Full Extension Drawer Guides with Smart Stop™ <i>New</i>	
	JOINERY	Stapled Butt Joint	Dovetail Joint	
	DEPTH	Base Cabinets and 21" Deep Vanities – 20" 18" Deep Vanities – 15 1/2"	Base Cabinets – 21" 21" Deep Vanities – 18"	
	CAPACITY	Rated at 75 lbs. Capacity per drawer for all guides		

*Depending upon application, plywood components may contain MDF or particleboard in accordance with ANSI/HPVA HP-1 standards.

**Dovetail drawer with 3/4" nominal thick all-wood sides and full extension guides.

How to Order Upgrade Features

Each door style described in this catalog is available in three construction methods - Standard, Select, and APC. Depending on what finish color is being specified, each one will have its own unique style number.

- Examples:**
- ▶ Westbury Square Wheat is #236
 - ▶ Westbury Square Wheat Select is #836
 - ▶ Westbury Square Wheat APC is #636

Select and APC Upgrades for Cabinets with Drawers

- ▶ Most cabinets **with drawers** can be upgraded to Select and All Plywood Construction.
- ▶ Cabinets upgraded to Select feature a standard Dovetail Drawer Box with Concealed Full Extension Smart Stop™ Drawer Guides.
- ▶ Cabinets upgraded to All Plywood Construction (APC) feature the Select Dovetail Drawer Box and Concealed Full Extension Smart Stop™ Drawer Guides along with APC Box Construction.

5-Piece Drawer Front Upgrades for Cabinets with Drawers

- ▶ Available on most cabinets with drawers on PLUS styles (except Teagan and Brellin).
- ▶ Can be applied to Standard, Select, and APC. (Select and APC will have additional upcharges)
- ▶ 5-Piece drawer front options are designated with a style name and a style number.
- ▶ 5-Piece drawer front pricing is an additional price added per drawer to the standard cabinet list price.

All Plywood Construction Upgrades (APC)

- ▶ Most walls, bases, tall, vanities, and universal cabinets can be upgraded to APC (All Plywood Construction).
- ▶ Add the following upcharge per cabinet to upgrade to APC.

Cabinet Front-Only (FO) Information and How to Order

- ▶ Cabinet front-onlys include the following parts (where applicable): frame, hinged door(s), drawer front(s), and non-matching toeboard.
- ▶ Parts not included: cabinets floor and cabinet accessories (door racks, wastebaskets, pull outs, etc).
- ▶ Front-onlys are available in Standard door style numbers and are not trimmable.
- ▶ Front-only list price is 70% of the cabinet list price. Not available to order through 20/20, contact customer service to order.

Not available on the following cabinet types (contact customer service for additional questions):

- ▶ Sink Base Cabinets or Sink Fronts
- ▶ Base-height Vanities that share a frame configuration with a standard Base Cabinet
- ▶ Base Roll Tray Cabinets 15"-24" wide or 39"-48" wide
- ▶ 12" deep Base Cabinets (Use SKU for 24" deep)
- ▶ 15" or 24" deep Wall Cabinets (Use SKU for 12" deep)
- ▶ 18" deep Vanity Cabinets (Use SKU for 21" deep)
- ▶ 12" deep Utility Cabinets (Use SKU for 24" deep)
- ▶ Corner Cabinets with angled frames (SCER, SCR, BRER, BLS, BECF)
- ▶ Cabinet Front-Onlys (FO) are only available in standard construction, and will not be available with Soft Close Hinges.

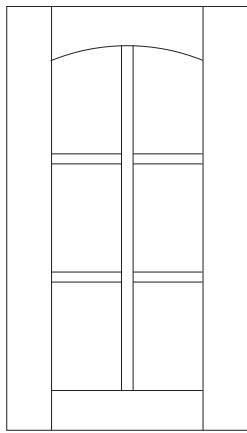

Standard Mullion Arch

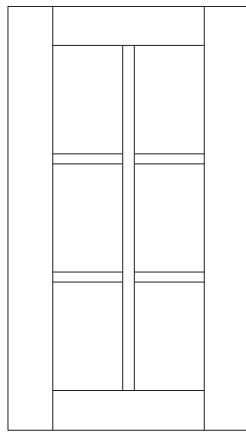

Standard Mullion Square

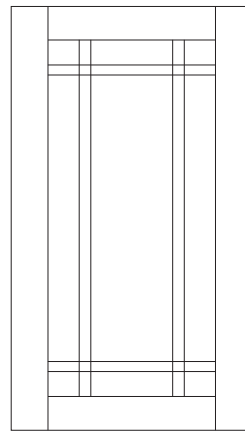

Shaker Mullion
Benton, Harrison,
& Winstead Only

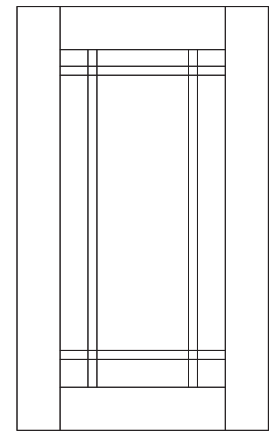

Shaker Mullion
Korbett

- ▶ Custom door sizes not available.
- ▶ Mullion Door cabinets are not available in Brellin, Teagan and VanWyke.
- ▶ Cabinets with Mullion Doors include installed, clear tempered glass, and matching Aristex™ interior.
- ▶ Specify L or R on all single door Arch styles.
- ▶ For complementary Wall Mullion Door cabinet in Teagan order as Winstead Maple, as Teagan features a slab door design.

Mullion Door Grid Configurations

Refer to drawings below to see the Standard & Shaker configurations for cabinet width & height.

STANDARD MULLION DOOR GRID CONFIGURATIONS						
Cabinet Width	Cabinet Height					
	18"	21"	24"	30"	36"	42"
15"	B			A	A	A
18"	B			A	A	A
21"	B			A	A	A
24"	B		B	A	A	A
27"	B		B	A	A	
30"	B	B	B	A	A	A
33"	B		B	A	A	A
36"	B	B	B	A	A	A
39"	B			A		
42"	B			A		
45"				A		
48"				A		
24" Diagonal				A	A	A
27" Diagonal				A	A	A

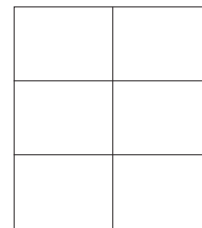

A



B

Available Door Styles:

Augusta, Avalon, Ayden, Briarcliff II, Dryden, Durham, Eastland, Grayson, Landen, Nantucket, Oakland, Overton, Pioneer, Radford, Saybrooke, Sinclair, Wentworth, Westbury

SHAKER MULLION DOOR GRID CONFIGURATIONS						
Cabinet Width	Cabinet Height					
	18"	21"	24"	30"	36"	42"
15"	C			C	C	C
18"	C			C	C	C
21"	C			C	C	C
24"	C		C	C	C	C
27"	C		C	C	C	C
30"	C	C	C	C	C	C
33"	C		C	C	C	C
36"	C	C	C	C	C	C
39"	C			C		
42"	C			C		
45"				C		
48"				C		
24" Diagonal				C	C	C
27" Diagonal				C	C	C

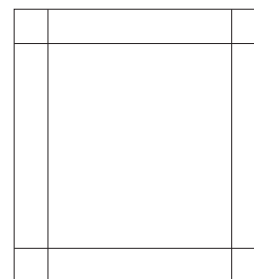

C

Available Door Styles:

Benton, Korbett, Harrison, Winstead

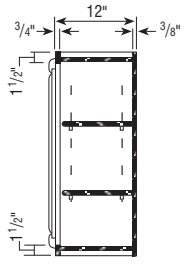

Wall Cabinet

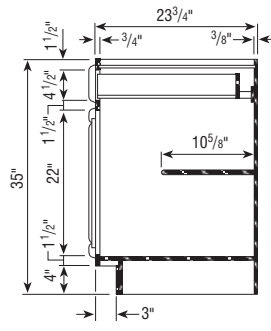

Base Cabinet

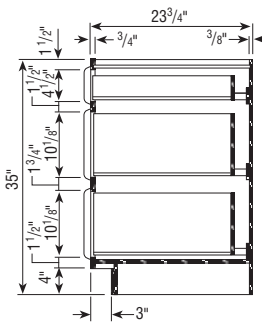

3-Drawer Base Cabinet

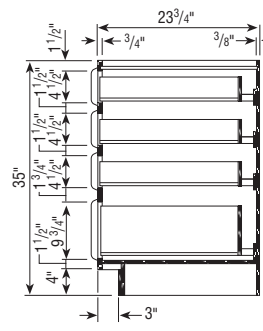

4-Drawer Base Cabinet

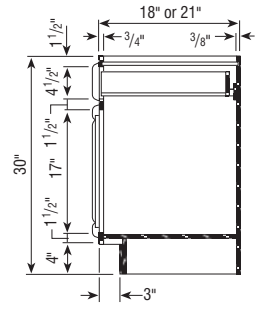

30" High Vanity Cabinet

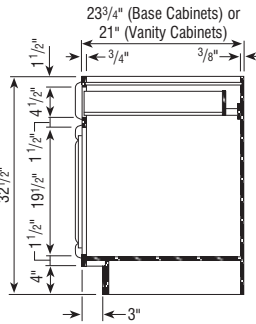

32 1/2" High Base/Vanity

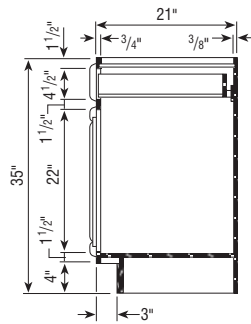

35" High Vanity Cabinet

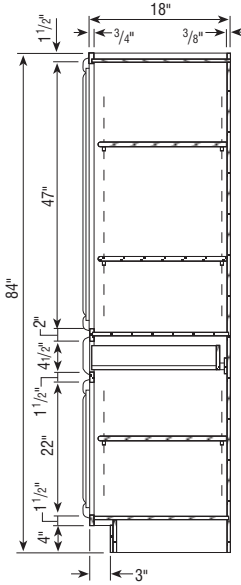

Linen Closet w/Drawer

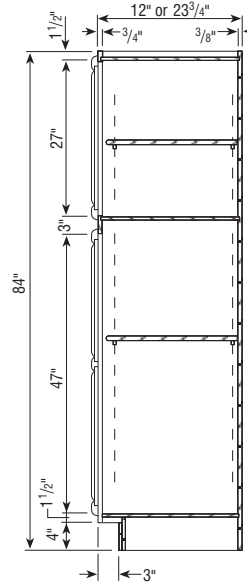

Utility Cabinet
Shelves not included

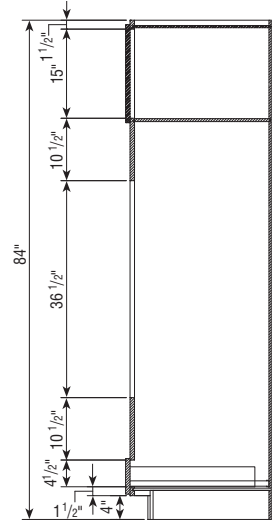

Double Oven Cabinet

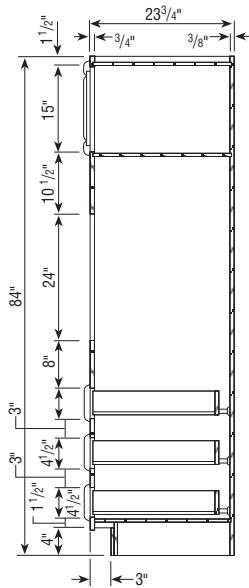

Single Oven Cabinet
1/16" Overlay Styles

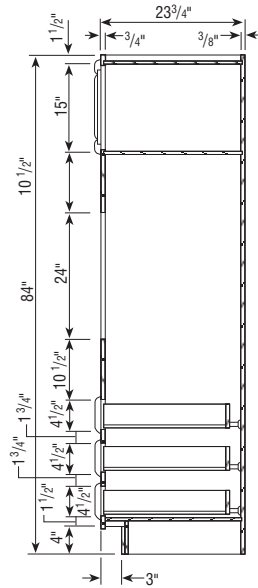

Single Oven Cabinet
1/4" Overlay Styles

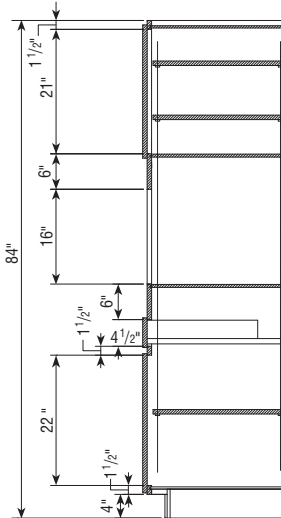

Tall Microwave Cabinet

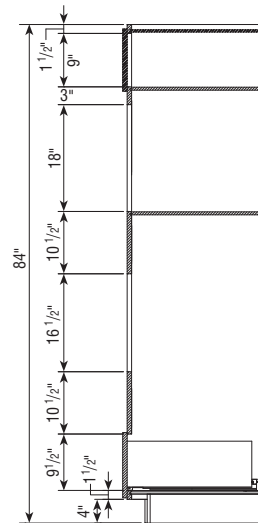

Oven Microwave Cabinet

Cabinet Specification Reference

- ▶ Number above wall cabinet represents height of cabinet.
- ▶ 1 1/2" Top and Bottom Rails on most cabinets.
- ▶ 1 1/2" Vertical Stiles on most cabinets, except OCSD/OD/TMW Cabinets.
- ▶ Drawer Box opening heights are 4 1/2" for small and 9 1/2", 9 3/4", or 10 1/8" for large (deep) drawers.

7/16" Overlay Door Styles:

- ▶ 1 1/16" Reveal around doors (1 1/16" of Face Frame shows).
- ▶ Door size for Single Door Cabinets: Frame opening + 7/8"
- ▶ Door size for Butt Door Cabinets: (Frame opening + 3/4")/2
- ▶ 4 1/2" High Drawer opening = 5 1/8" Drawer Front.

Full Overlay Door Styles:

- ▶ 1/4" Reveal around doors (1/4" of Face Frame shows).
- ▶ Door size for Single Door Cabinets: Frame opening + 2 1/2"
- ▶ Door size for Butt Door Cabinets: (Frame opening + 2 3/8")/2
- ▶ 4 1/2" High Drawer opening = 5 3/4" Drawer Front.

84" High Application

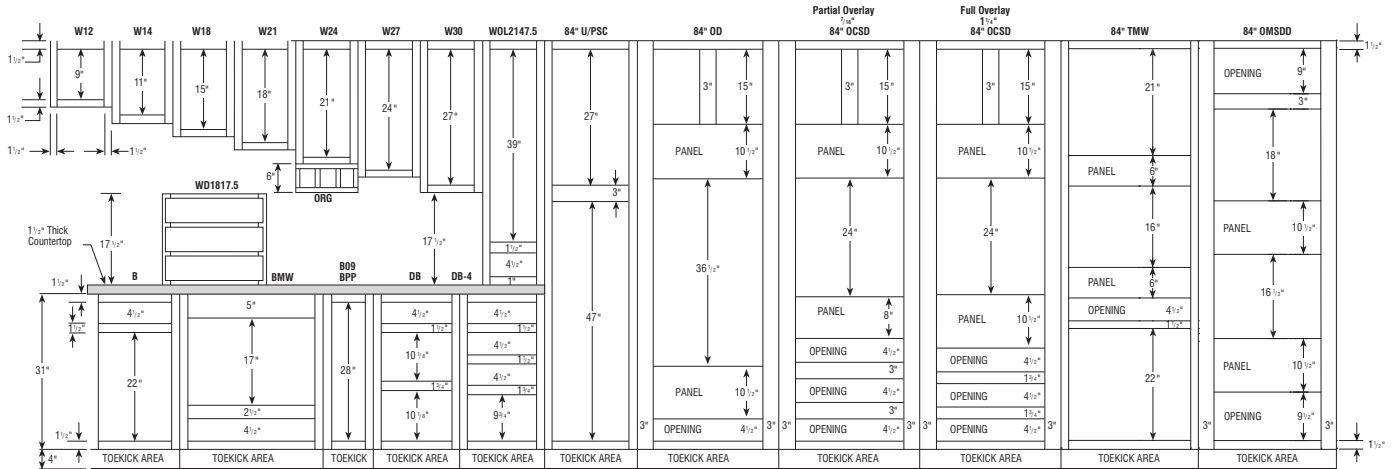

90" High Application

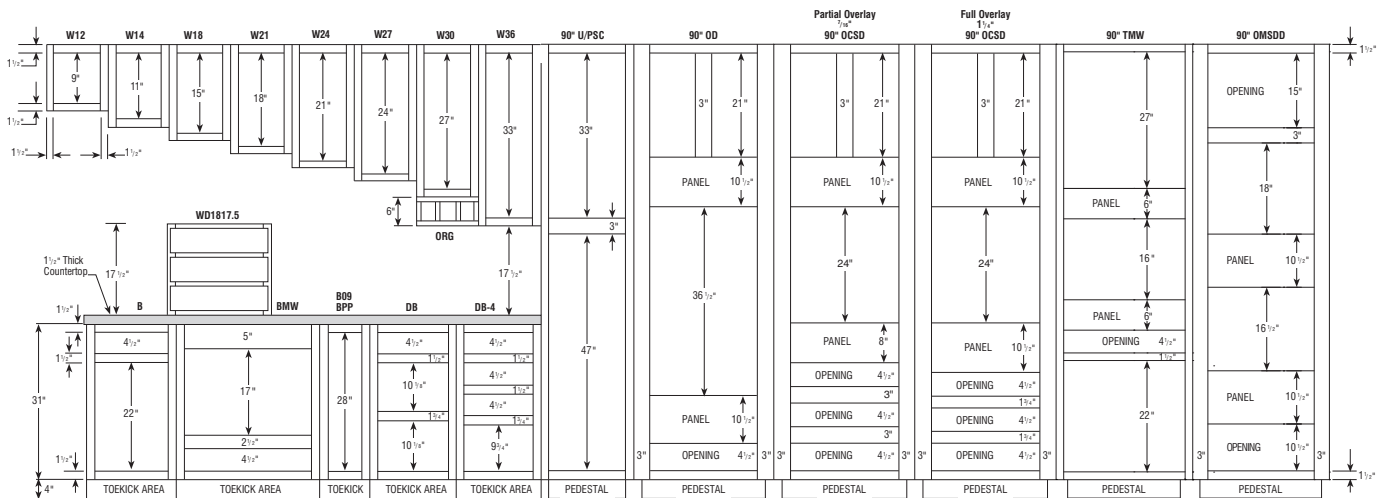

96" High Application

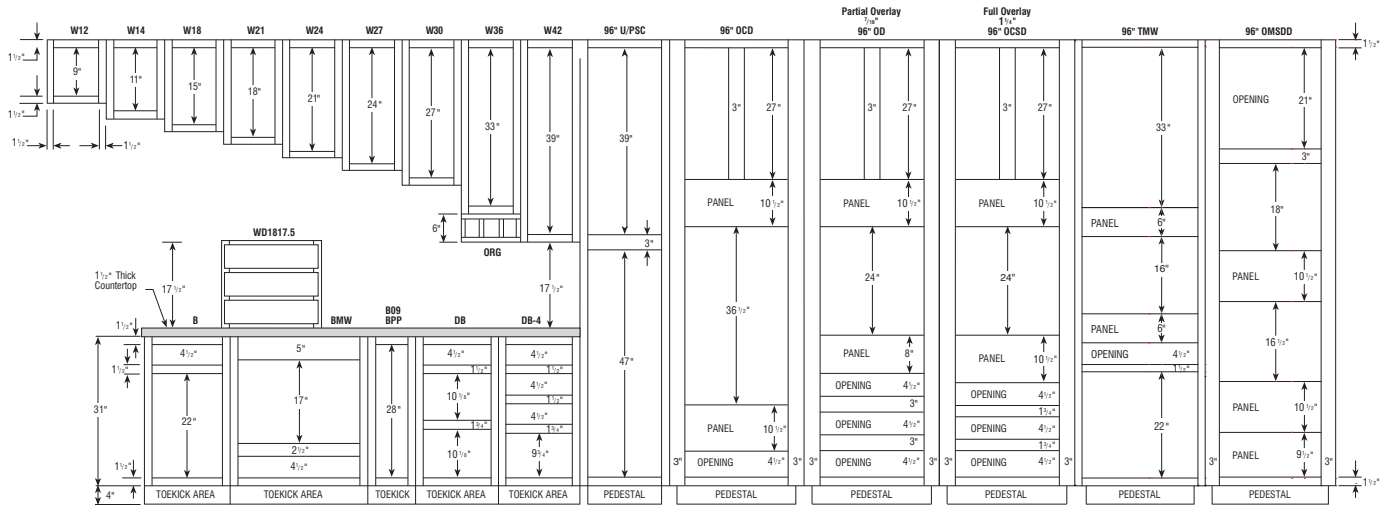

30" High Desk Cabinets

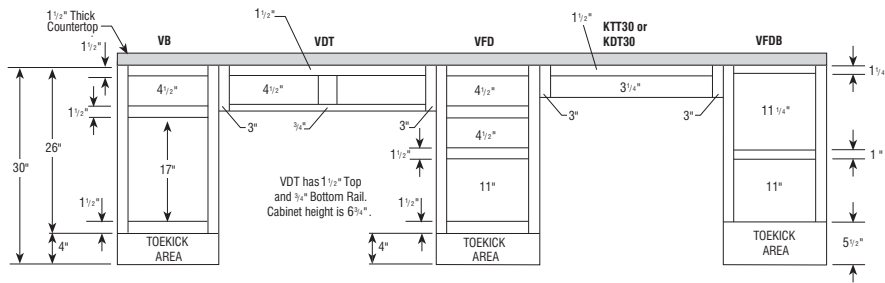

30" High Vanity Cabinets

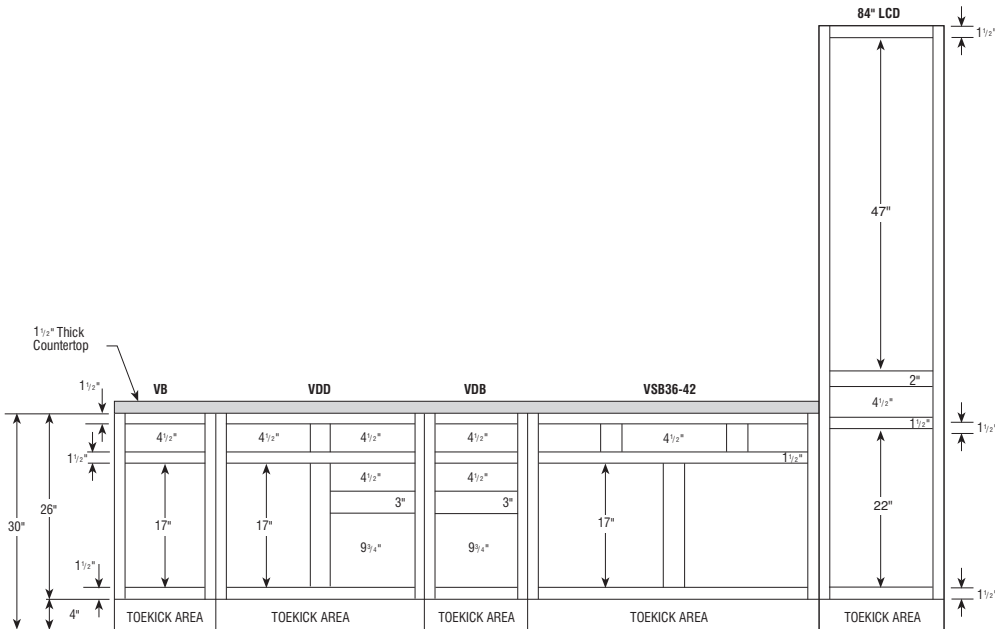

32 1/2" High Vanity Cabinets

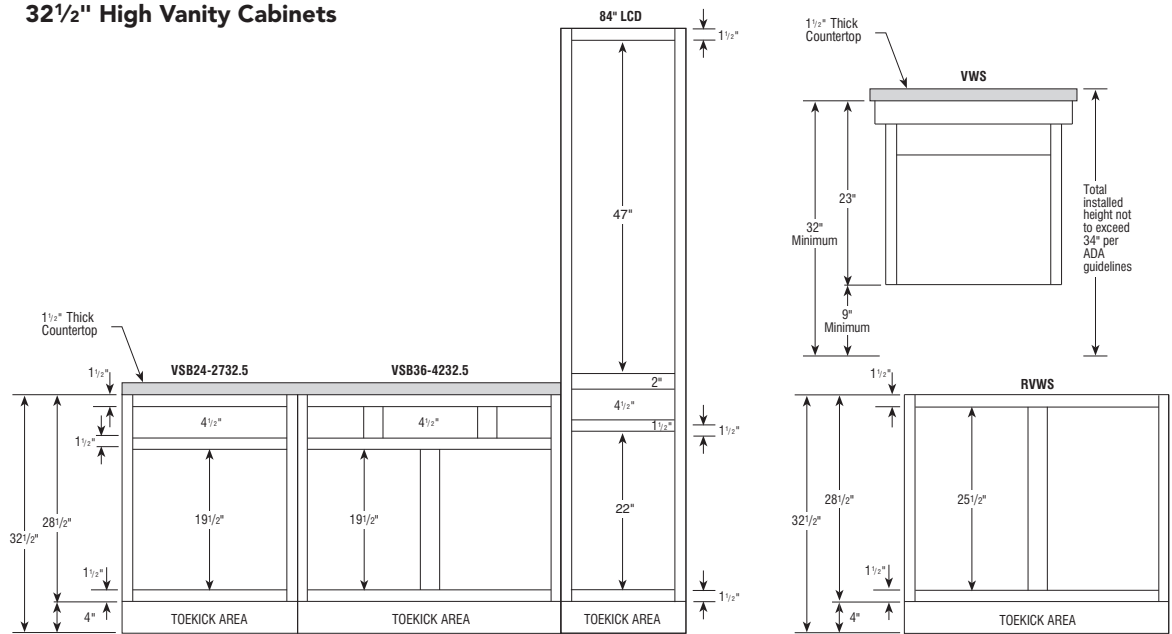

35" High Vanity Cabinets

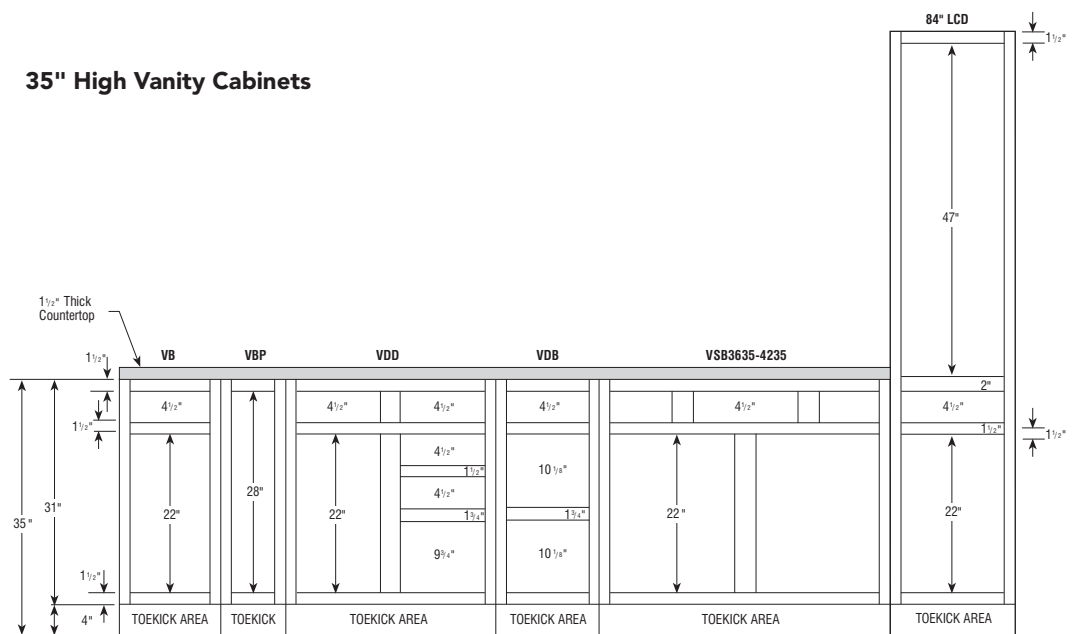

32 1/2" High Base Cabinets (Universal Design Application)

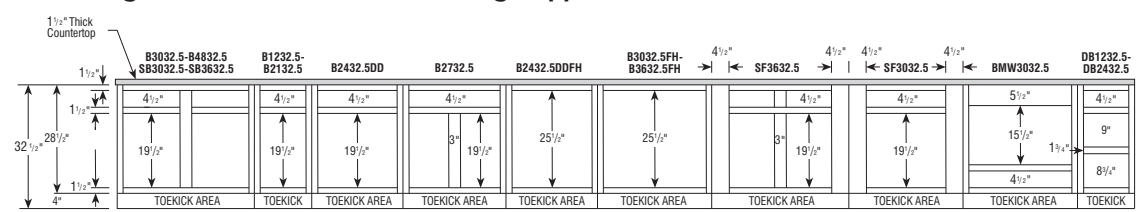

- ▶ 32 1/2" High Cabinets are designed to comply with ADA (Americans with Disabilities Act) requirements of a 34" high overall counter height, including a 1 1/2" counter top.
- ▶ Refer to ADA guidelines for more details on designing in small spaces where extra width for turning radius may be required.
- ▶ Available in the following styles:
 - ▶ Avalon Maple
 - ▶ Benton Birch
 - ▶ Landen Maple
 - ▶ Oakland Oak
 - ▶ Radford Maple
 - ▶ Saybrooke Birch
 - ▶ Sinclair Birch
 - ▶ Westbury Oak
- ▶ For Vanity Sink Base Cabinets, see page 124. For a Vanity Wall Sink Cabinet, see page 140.

Did you remember...

Styles and Pricing

- ▶ Select Door Style and Pricing Level from your 20/20 design program. (If copying and pasting from one order to another, remember to reset styles and pricing.)

End Finishing Options

Consider exposed end options:

- ▶ Use APC for exposed cabinets. The veneer finished end will age uniformly with the rest of the kitchen.
- ▶ Apply $\frac{3}{16}$ " veneer skin to hide $\frac{3}{16}$ " reveal. This will allow the ends to age uniformly with the rest of the kitchen and will make it flush.
- ▶ Apply decorative door kit (DBEP, DWEP, DVEP). This kit includes $\frac{3}{16}$ " veneer skin, decorative doors, and screws for field installation.
- ▶ Underside of Wall Cabinets are natural maple laminate, with a few exceptions, such as WMD, WOL, WPG, or white cabinets. Use light rail and skin to hide, especially when designing with Peninsula Wall Cabinets.

Wood and Finish Characteristics

Review specific details with the customer:

- ▶ Mineral Streaks, Birdseye Dots, Grain Variations (especially Hickory and Rustic Birch).
- ▶ Color Variations/Darkening (especially Cherry).
- ▶ Finish Variations (Glazes are "consistently inconsistent"), hairline cracks may develop at frame joints on painted frames.

Clearances

- ▶ Add fillers between end cabinets and walls on full overlay door styles.
- ▶ Allow space between door/window trim and end cabinets for countertop and top moulding overhang.
- ▶ Include refrigerator door hinges in overall refrigerator height when placing cabinets above it.
- ▶ For minimum pull requirements on blind corner cabinets, see charts on pages 76, 98, and 138.
- ▶ Allow sufficient clearance (3") on each side of accessory cabinets (such as Roll-Out trays, swingout units, etc).
- ▶ Doors on these cabinets must open fully for accessories to be functional.
- ▶ Ensure the height between the cooktop and range hood is 24" to meet NKBA guidelines.

Advise customer carefully on upper cabinet/microwave advantages/disadvantages as follows:

- ▶ Minimum of 18" from cooktop to upper cabinet/above the range microwave which allows for easy access to either, but less room over back burner.
- ▶ Minimum of 21" from cooktop to upper cabinet/microwave which allows for access to large pots on back burner of cooktop, but longer reach to microwave.

Fillers

- ▶ Place fillers toward end of run where least conspicuous if needed.
- ▶ Attach overlay fillers on top of base, wall, or tall fillers when using full overlay door styles to maintain a consistent reveal. Don't forget to include blind corner fillers.

Matching Interior Cabinets/Glass Options

- ▶ Use light rail and skin to hide color variation between bottom of WOL Cabinets next to any other cabinets.
- ▶ Verify mullion door grid matches customer expectations. (Advise customer of shaker grid pattern.)

Mouldings

- ▶ All toekicks must be skinned with TOEKICK, TOEKICK8, or TOEKICKPLY8.
- ▶ Verify the correct amount of moulding has been ordered.
- ▶ Order toekick caps.
- ▶ Order extra scribe.

Islands and Peninsulas

- ▶ Consider standard height bars are 35" tall and require 19" knee space. Raised bars are 42" tall.
- ▶ Consider Base Peninsula Cabinets (PB) are 23 $\frac{3}{4}$ " deep and require 12" of knee space.
- ▶ Use outside corner moulding if a skin is exposed on the back of the island.

Appliances

- ▶ Do not place dishwashers next to diagonal front cabinet (interference) or next to a range (no countertop support).
- ▶ Verify refrigerator door has enough clearance to open beyond 90 degrees so refrigerator drawers can be utilized. Refer to appliance manufacturer's specifications.
- ▶ Thermofoil will not withstand sustained temperatures in excess of 170°F. A 3" filler or heat shield is required between any thermofoil surface and any heat source to be in compliance with cabinet warranty.

Special Considerations

- ▶ Consider V-Groove skins and/or decorative doors on exposed cabinet sides in glazed kitchen.

Miscellaneous

- ▶ Order touch-up kit for future repairs.

Tips to the Installer

#10 x 2 $\frac{1}{2}$ " installation screws are furnished and packaged inside all cabinets for attachment to wall. Proper wall stud or ceiling joist installation is essential for Wall and Peninsula Cabinets to support weight. Whenever possible, cabinets should be attached to each other for additional strength. Excessive weight should not be put on cabinets hung by themselves. Shimming may be required to ensure proper alignment. Wallboard alone is not strong enough to support the cabinets.

Aristokraft's Warranty does not cover damage caused by improper installation. Please be sure to install cabinets properly and review all installation instructions. If you have questions, please contact your representative or customer service.

Wood Dust Warning

When cutting, sanding, sawing, or shaping cabinets or wood products, you are likely to generate wood dust. For your own safety, Aristokraft recommends that you wear a protective mask to prevent breathing wood dust. We also recommend eye protection to avoid injury by flying wood chips or sawdust during cabinet installation.

Kitchen Planning Guidelines

Door/Entry

- ▶ Door opening should be at least 32" wide.

Door Interference

- ▶ Entry door should not interfere with safe appliance operation or appliance doors.

Distance Between Work Centers

- ▶ With three work centers, the total distance traveled should not be more than 26' with no single leg of the triangle less than 4' or more than 9'.
- ▶ With more than three work centers, each additional travel distance to another work center should be no less than 4' or more than 9'. Each leg is measured from the center-front of the appliance/sink. No work triangle leg should intersect an island/peninsula by more than 12".

Separating Work Centers

- ▶ A tall obstacle should not separate two primary work centers. A properly recessed tall corner unit is acceptable.

Work Triangle Traffic

- ▶ Major traffic patterns should not cross through the basic work triangle.

Work Aisle

- ▶ The work aisle should be at least 42" for one cook and at least 48" for multiple cooks.

Walkway

- ▶ The walkway width should be at least 36".

Traffic Clearance At Seating

- ▶ Allow 32" of clearance from the table to wall/obstacle if no traffic passes behind a seated diner. If traffic passes behind the diner, allow at least 36" to edge past or 44" to walk past.

Seating Clearance

- ▶ 30" high tables/counters should allow a 24" wide by 18" deep space for each seated diner.
- ▶ 36" high counters should allow a 24" wide by 15" deep space for each seated diner and at least 15" kneespace.
- ▶ 42" high counters should allow a 24" wide by 12" deep space for each seated diner and at least 12" kneespace.

Clean-Up/Prep Sink Placement

- ▶ With only one sink, locate it adjacent to or across from the cooking surface and refrigerator.

Clean-Up/Prep Sink Landing Area

- ▶ Include at least a 24" landing space on one side of the sink and 18" on the other.
- ▶ If all the countertop at the sink is not the same height, plan a 24" landing space on one side of the sink and 3" of countertop frontage on the other, both at the same height of the sink.

Preparation/Work Area

- ▶ Include a section of countertop at least 36" wide x 24" deep next to the sink for a work area.

Dishwasher Placement

- ▶ Nearest edge of dishwasher should be within 36" of nearest edge of sink. Provide at least 21" of standing space between the edge of the dishwasher and countertop frontage/appliances/cabinets which are placed at a right angle to the dishwasher.

Waste Receptacles

- ▶ Include at least 2 waste receptacles, one near the sink and the other nearby for recycling.

Auxiliary Sink

- ▶ Provide at least 3" of countertop frontage on one side of the auxiliary sink and 18" on the other side, both at the same height of the sink.

Refrigerator Landing Area

- ▶ Include at least 15" of landing area on the handle side of the refrigerator, 15" on either side of a side-by-side refrigerator, 15" of landing space which is no more than 48" across from the front of the refrigerator, and 15" above or adjacent to any under counter-style refrigerator.

Cooking Surface Landing Area

- ▶ Include a minimum of 12" of landing area on one side of the cooking surface and 15" on the other.
- ▶ If cooking surface is at a different countertop height than the rest of the kitchen, then the 12" and 15" landing areas must be the same height as the cooking surface.
- ▶ For safety reasons, in an island or peninsula situation, the countertop should extend a minimum of 9" behind the cooking surface if the counter height is the same height as the cooking surface.

Cooking Surface Clearance

- ▶ Allow 24" between the cooking surface and a protected noncombustible surface above it.
- ▶ At least 30" of clearance is required between the cooking surface and an unprotected/combustible surface above it.
- ▶ If a microwave hood is used, then the manufacturer's specifications should be followed.

Cooking Surface Ventilation

- ▶ A correctly sized, ducted ventilation system is recommended for all cooking surface appliances. The recommended minimum is 150 CFM.
- ▶ Code requires that the manufacturer's specifications be followed. Minimum exhaust rate for a ducted hood is 100 CFM and must be ducted to the outside.
- ▶ Make-up airway may need to be provided. Refer to local codes.

Cooking Surface Safety

- ▶ Do not locate cooking surface under an operable window.
- ▶ Window treatments above cooking surface should not use flammable materials.
- ▶ Place a fire extinguisher near the kitchen exit away from cooking equipment.

Microwave Oven Placement

- ▶ The ideal location for the bottom of the microwave is 3" below the principle user's shoulder, but no more than 54" above the floor.

Kitchen Planning Guidelines (continued)

Microwave Landing Area

- ▶ Provide at least 15" above, below, or adjacent to the handle side of a microwave oven.

Oven Landing Area

- ▶ Include at least 15" next to or above the oven.
- ▶ A 15" landing area that is not more than 48" away is also acceptable as long as the oven does not open into a walkway.

Combining Landing Areas

- ▶ If two landing areas are adjacent to one another, determine a new minimum for the two by taking the longer of the two and adding 12".

Countertop Space

- ▶ A total of 158" of countertop frontage, 24" deep, with at least 15" clearance above is needed to accommodate all landing, preparation, work, and storage areas.

Countertop Edges

- ▶ Clipped or round corners rather than sharp edges are recommended on all counters.

Storage

- ▶ The recommended total shelf/drawer frontage for a small kitchen (less than 150 square feet) is 1400", a medium kitchen (151 to 350 square feet) is 1700", and for a large kitchen (greater than 350 square feet) is 2000".

Sizes:	S	M	L
Wall	300"	360"	360"
Base	520"	615"	660"
Drawer	360"	400"	525"
Pantry	180"	230"	310"
Misc.	40"	95"	145"

- ▶ The totals for wall, base, drawer, and pantry shelf/drawer frontage can be adjusted upward or downward as long as the recommended total stays the same.

Storage At Clean-Up/Prep Sink

- ▶ The recommended total for a small kitchen is 400", a medium kitchen is 480", a large kitchen is 560", and should be located within 72" of the centerline of the main clean-up/prep sink.

Corner Cabinet Storage

- ▶ At least one corner cabinet should include a functional storage device.

Electrical Receptacles

- ▶ GFCI (Ground-Fault-Circuit-Interrupter) protection is required on all receptacles servicing countertop surfaces within the kitchen.

Lighting

- ▶ Every work surface should be well illuminated. At least one wall switch-controlled light must be placed at the entrance.
- ▶ Window/skylight area, equal to at least 8% of the total square footage of the kitchen, or a total living space which includes a kitchen, is required.

Bathroom Planning Guidelines

Door/Entry

- ▶ Doorway opening should be at least 32", requiring a minimum 2' 10" wide door.

Door Interference

- ▶ Entry or fixture doors should not interfere with each other and/or the safe use of fixtures/cabinets.

Ceiling Height

- ▶ Bathroom floor to ceiling minimum height is 80". A shower or tub with a shower head shall have a minimum floor to ceiling height of 80" above a minimum area 30" x 30" at the shower head.

Clear Space

- ▶ Plan a clear space of 30" from the front edge of all fixtures to any opposite bath fixture, wall, or obstacle.
- ▶ A minimum space of at least 21" is required in front of lavatory, toilet, bidet, and tub, with a 24" minimum space in front of a shower entry.

Single Lavatory Placement

- ▶ The distance from the centerline of the lavatory to the sidewall/tall obstacle should be at least 20".
- ▶ The minimum distance required is 15". The minimum distance required between a wall and the edge of a lavatory is 4".

Double Lavatory Placement

- ▶ The distance between the centerlines of two lavatories should be at least 36".
- ▶ The minimum distance required is 30".
- ▶ The minimum distance required between the edges of two lavatories is 4".

Lavatory/Vanity Height

- ▶ The height for a lavatory varies between 32" – 43" to fit the user.

Countertop Edges

- ▶ Clipped or round corners rather than sharp edges are recommended on all counters.

Shower Size

- ▶ The interior shower size should be at least 36" x 36". The minimum interior shower size required is 30" x 30".

Organization Solutions



Look for the symbol (shown left) used throughout this book indicating organization solutions. Reference the chart below for organization applications.

		CABINET WIDTH														PAGE	
		6"	9"	12"	15"	18"	21"	24"	27"	30"	33"	36"	39"	42"	45"		48"
WALL CABINETS																	
DCR2430	Diagonal Corner Roto Wall Cabinet							✓ [†]									75
MWC_ _ _ _ B	Microwave Wall Cabinets (36" & 48" High)								✓	✓	✓						63
MWC_ _ _ _ _ B	Wall Built-In Microwave Cabinets (36" & 42" High)								✓	✓	✓						64
WD1817.5	Wall Drawer Unit					✓											62
WER24_ _	Wall Easy Reach Cabinets							✓ [†]									75
WMC12_ _	Wall Message Center Cabinets			✓													62
WR_ _ _ _	Wine Rack Cabinets (12" High)								✓		✓						61
WPR3018	Wall Plate Rack Cabinet									✓							61
BASE CABINETS																	
B_ _ RT	Base Cabinets w/ Roll Trays				✓	✓	✓	✓	✓	✓	✓	✓	✓	✓	✓	✓	84
B_ _ RT-2	Base Cabinets w/Double Roll Trays				✓	✓	✓	✓	✓	✓	✓	✓	✓	✓	✓	✓	84
B_ _ TD <i>New</i>	Base Cabinet with Tray Divider		✓	✓													83
BBCPO6	Base Box Column Pull-Out Cabinet	✓															87
BEC12	Base End Cabinet (One Door)			✓													100
BECF24	Base End Cabinet (Two Doors)							✓									100
BLS_ _	Base Lazy Susan Cabinets										✓ [†]	✓ [†]					97
BMW_ _ 35	Base Built-In Microwave Cabinet									✓	✓	✓					95
BPP09	Base Pantry Pull-Out Cabinet		✓														87
BPPP24	Base Pots & Pans Pull-Out							✓									90
BRER36	Base Roto Easy Reach Cabinet											✓ [†]					96
BSC30PRB	Base SuperCabinets™									✓							85
BSC30RPB	Base SuperCabinets™									✓							85
BSC36PRPB	Base SuperCabinets™										✓						86
BWB_ _	Base Wastebaskets					✓	✓										90
BWB15FH	Base Wastebasket w/Full Height Door				✓												90
SB_ _ STNSB	Sink Base SuperCabinets™									✓		✓					92
SB_ _ STSB	Sink Base SuperCabinets™									✓		✓					91
SCER36	Square Corner Easy Reach Cabinet											✓ [†]					96
SCR_ _	Square Corner Roto Cabinets										✓ [†]	✓ [†]					96
TALL CABINETS																	
PSC_ _ _ _ (B)	Pantry SuperCabinets™ (84", 90", 96" Tall)				✓	✓		✓		✓		✓					112
U_ _ _ _ (B)	Utility Cabinets (84", 90", 96" Tall - 23¾" Deep)				✓	✓		✓		✓		✓					114
U_ _ _ _ 12(B)	Utility Cabinets (84", 90", 96" Tall - 12" Deep)				✓	✓		✓		✓		✓					114
OTHER CABINETS																	
VFDB18	Vanity File Drawer Base					✓											118
VFD_ _	Vanity File Drawers					✓	✓										119
VANITY CABINETS																	
LCD_ _	Linen Closets w/Drawer (21" Deep)					✓		✓									132
LCD_ _ 18	Linen Closets w/Drawer (18" Deep)					✓		✓									132
LCD18SC	Linen Closet w/Removable Hamper					✓											133
VBP0935	Vanity Base Pull-Out		✓														121
VSB_ _ 35STNSB	Vanity Sink Base SuperCabinets™									✓		✓					127
VSB_ _ 35STSB	Vanity Sink Base SuperCabinets™									✓		✓					126
ACCESSORIES																	
ACS_ _ 17.5	Appliance Centers - Straight					✓		✓		✓							160
AC2417.5	Appliance Center - Diagonal							✓ [†]									160
PCDT	Plastic Cutlery Tray (15", 18", 21", 24" Widths)				✓	✓	✓	✓									162
WCDT	Wood Cutlery Tray				✓	✓	✓	✓									162
DWBR	Double Wastebasket Roll-Out (Fits: 15" Bases)				✓												167
PDO	Pegged Dish Organizer											✓					162
SRD_ _	Wall Spice Rack (Wall Cabinet Accessory)				✓	✓	✓										161
UPK_ _ WH	Pantry Roll-Out Kits				✓	✓		✓		✓		✓					166

[†]Solutions for the corner.

NOTES ✓

- ▶ To create the Americana design, start with F396 and add MICROWN8/PSMICROWN8 and MROPE8 insert.
- ▶ To create the Art Linea design, start with MCTB8, add MBAT8 and another MCTB8 and support with cleat.

Americana

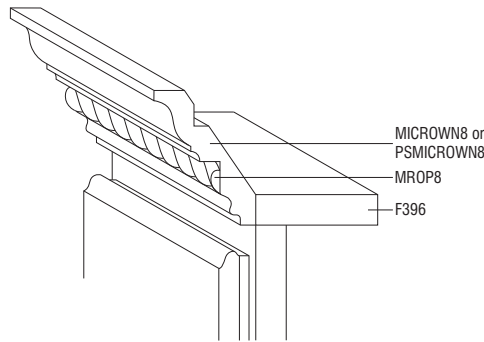

Art Linea

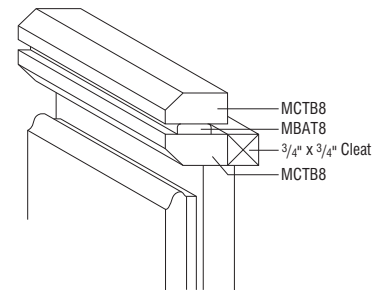

NOTES ✓

- ▶ To create the Aztec design, start with F396 and add MFOLCR8/PSMFOLCR8 and MDENTIL8 insert.
- ▶ To create the Baroque design, start with F396 and add MFOLCR8/PSMFOLCR8 and MROPE8 insert.

Aztec

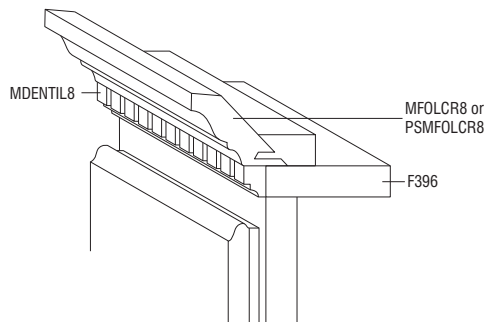

Baroque

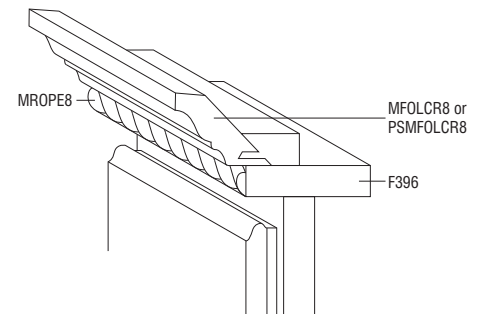

NOTES ✓

- ▶ To create the Georgian design, start with MBS8 and add MCROWN8/PSMCROWN8 and support with cleat.
- ▶ To create the Classical design, start with MTST8/PSMTST8 and add F396 cut to 1 1/2\"/>

Georgian

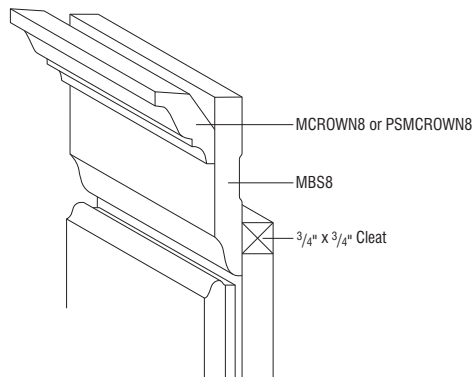

Classical

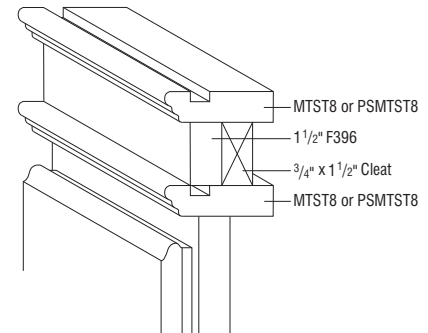

Mission

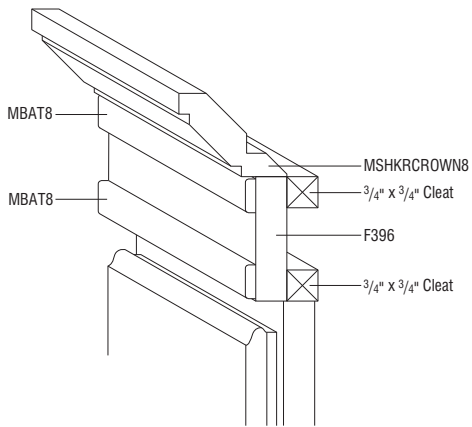

Monticello

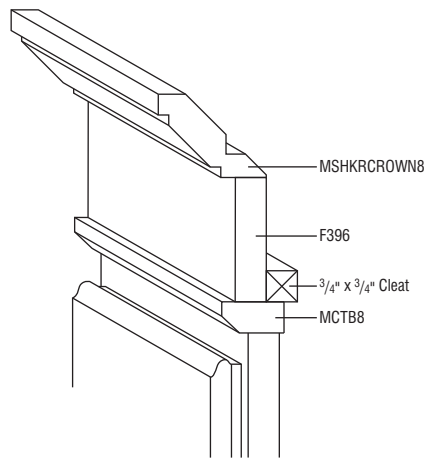

NOTES ✓

- ▶ To create the Mission design, start with F396 and add two MBAT8 and MSHKRCROWN8 and support with cleat.
- ▶ To create the Monticello design, start with F396 and add MCTB8 and MSHKRCROWN8 and support with cleat.
- ▶ Available in Maple finishes only.

Monarch

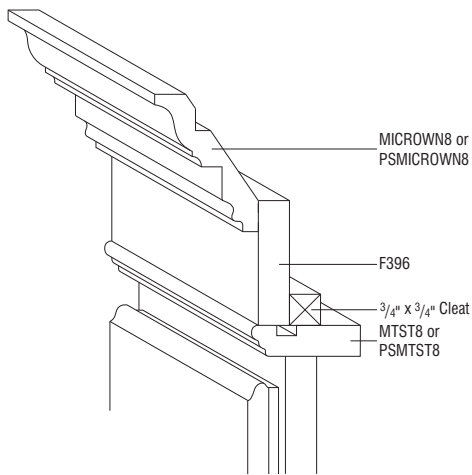

Regency

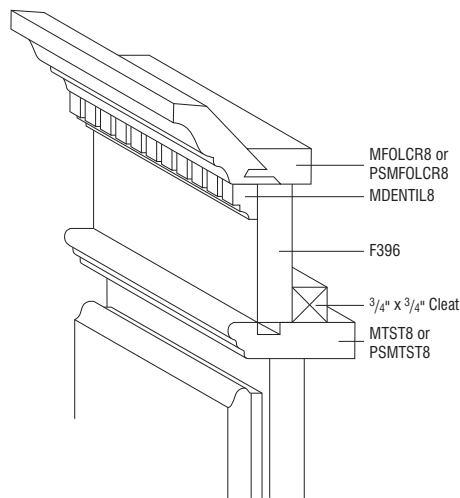

NOTES ✓

- ▶ To create the Monarch design, start with MTST8/PSMTST8 and add F396 and MICROWN8/PSMICROWN8 and support with cleat.
- ▶ To create the Regency design, start with MTST8/PSMTST8 and add F396 and MFOLCR8/PSMFOLCR8 and MDENTIL8 insert and support with cleat.

Renaissance

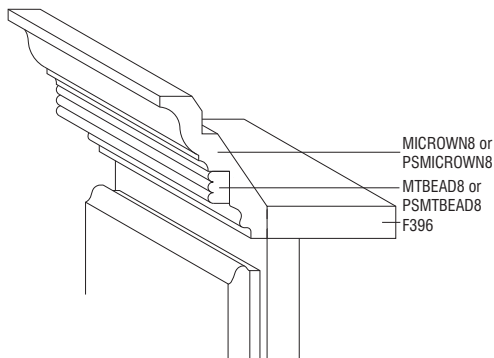

Romanesque

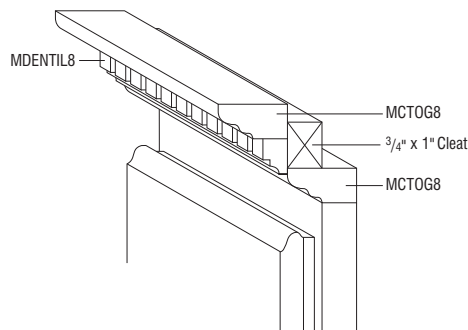

NOTES ✓

- ▶ To create the Renaissance design, start with F396 and add MICROWN8/PSMICROWN8 and MTBEAD8/PSMTBEAD8 insert.
- ▶ To create the Romanesque design, start with MCTOG8 and add another MCTOG8 and MDENTIL8 insert and support with cleat.

Wall Cabinets, 12" High, 12" Deep

NOTES ✓

- ▶ Shelves not available with cabinets less than 24" in height.
- ▶ Cabinets use standard natural maple interior, excluding white which has a white interior.
- ▶ Center door on W4212, W4512, and W4812 will be hinged on the left.

DESIGN SOLUTIONS

- ▶ Apply an End Panel Skin to create a flush end on the side of a Wall cabinet if installed at the end of a run for ease of Moulding installation.

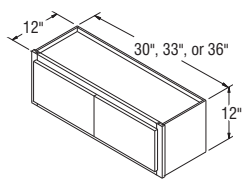

W3012B
W3312B
W3612B

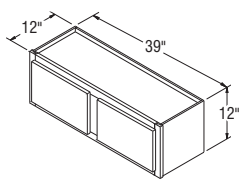

W3912

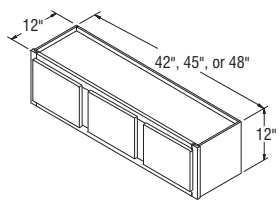

W4212
W4512
W4812

NOTES ✓

- ▶ Shelves not available with cabinets less than 24" in height.
- ▶ Cabinets use standard natural maple interior, excluding white which has a white interior.
- ▶ Center door on W4214 and W4814 will be hinged on the left.

DESIGN SOLUTIONS

- ▶ Apply an End Panel Skin to create a flush end on the side of a Wall cabinet if installed at the end of a run for ease of Moulding installation.

Wall Cabinets, 14" High, 12" Deep

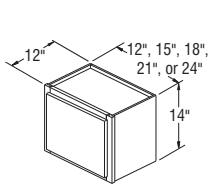

W1214* New
W1514* New
W1814* New
W2114* New
W2414* New

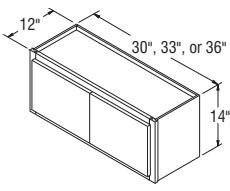

W3014B
W3314B
W3614B

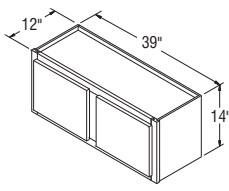

W3914

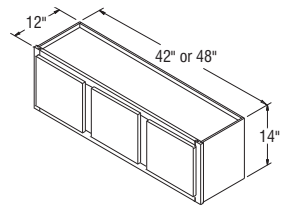

W4214
W4814

*Specify L or R on all single door Arch styles.

NOTES ✓

- ▶ Shelves not available with cabinets less than 24" in height.
- ▶ Cabinets use standard natural maple interior, excluding white which has a white interior.

DESIGN SOLUTIONS

- ▶ Apply an End Panel Skin to create a flush end on the side of a Wall cabinet if installed at the end of a run for ease of Moulding installation.

Wall Cabinets, 18" High, 12" Deep

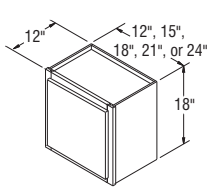

W1218* New
W1518* New
W1818* New
W2118* New
W2418*

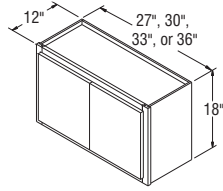

W2718B
W3018B
W3318B
W3618B

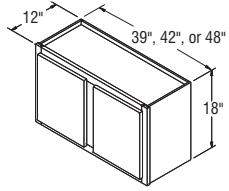

W3918
W4218
W4818

*Specify L or R on all single door Arch styles.

Wall Cabinets, 18" High, 15" Deep

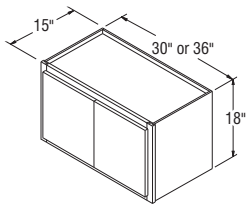

W301815B
W361815B

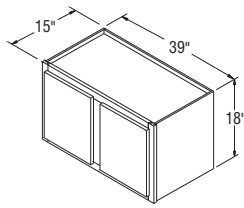

W391815

NOTES ✓

- ▶ Shelves not available with cabinets less than 24" in height.
- ▶ Cabinets use standard natural maple interior, excluding white which has a white interior.
- ▶ When varying heights, make sure to also vary depths to allow moulding to lie against adjacent side of cabinet.

DESIGN SOLUTIONS

- ▶ Apply an End Panel Skin to create a flush end on the side of a Wall cabinet if installed at the end of a run for ease of Moulding installation.

Wall Cabinets, 21" High, 12" Deep

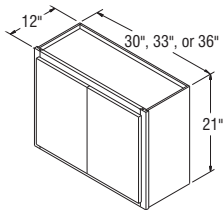

W3021B
W3321B
W3621B

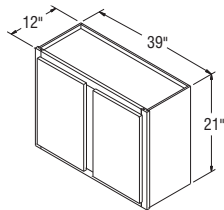

W3921

NOTES ✓

- ▶ Shelves not available with cabinets less than 24" in height.
- ▶ Cabinets use standard natural maple interior, excluding white which has a white interior.

DESIGN SOLUTIONS

- ▶ Apply an End Panel Skin to create a flush end on the side of a Wall cabinet if installed at the end of a run for ease of Moulding installation.

Wall Cabinets, 21" High, 15" Deep

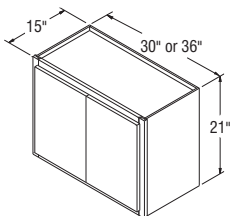

W302115B
W362115B

NOTES ✓

- ▶ Shelves not available with cabinets less than 24" in height.
- ▶ Cabinets use standard natural maple interior, excluding white which has a white interior.
- ▶ When varying heights, make sure to also vary depths to allow moulding to lie against adjacent side of cabinet.

DESIGN SOLUTIONS

- ▶ Apply an End Panel Skin to create a flush end on the side of a Wall cabinet if installed at the end of a run for ease of Moulding installation.

Wall Cabinets, 24" High, 12" Deep

NOTES ✓

- ▶ Center shelf support clip included on Wall Double Door cabinets with center mullion.
- ▶ One adjustable shelf.
- ▶ Cabinets use standard natural maple interior, excluding white which has a white interior.

DESIGN SOLUTIONS

- ▶ Apply an End Panel Skin to create a flush end on the side of a Wall cabinet if installed at the end of a run for ease of Moulding installation.

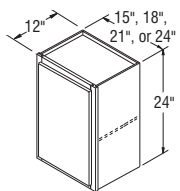

W1524*
W1824*
W2124*
W2424*

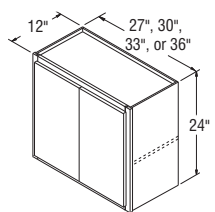

W2724B
W3024B
W3324B
W3624B

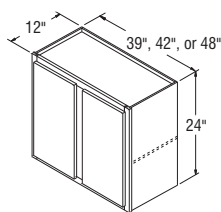

W3924
W4224
W4824

*Specify L or R on all single door Arch styles.

Wall Cabinets, 24" High, 15" Deep

NOTES ✓

- ▶ Center shelf support clip included on Wall Double Door cabinets with center mullion.
- ▶ One adjustable shelf.
- ▶ Cabinets use standard natural maple interior, excluding white which has a white interior.
- ▶ When varying heights, make sure to also vary depths to allow moulding to lie against adjacent side of cabinet.

DESIGN SOLUTIONS

- ▶ Apply an End Panel Skin to create a flush end on the side of a Wall cabinet if installed at the end of a run for ease of Moulding installation.

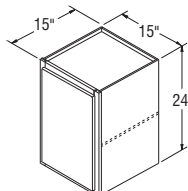

W152415*

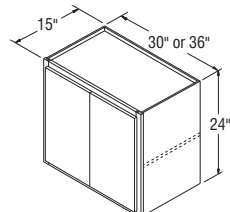

W302415B
W362415B

*Specify L or R on all single door Arch styles.

Wall Cabinets, 27" High, 12" Deep

NOTES ✓

- ▶ Center shelf support clip included on Wall Double Door cabinets with center mullion.
- ▶ One adjustable shelf.
- ▶ Cabinets use standard natural maple interior, excluding white which has a white interior.

DESIGN SOLUTIONS

- ▶ Apply an End Panel Skin to create a flush end on the side of a Wall cabinet if installed at the end of a run for ease of Moulding installation.

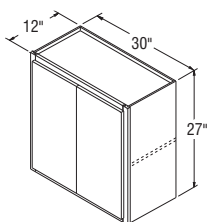

W3027B

Wall Cabinets, 30" High, 12" Deep

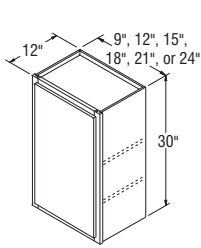

W0930
W1230*
W1530*
W1830*
W2130*
W2430*

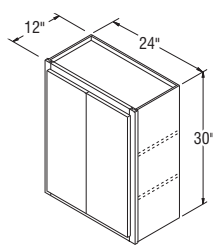

W2430DD

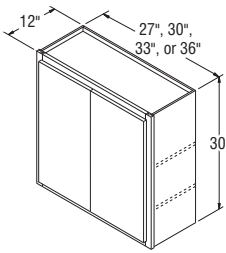

W2730B
W3030B
W3330B
W3630B

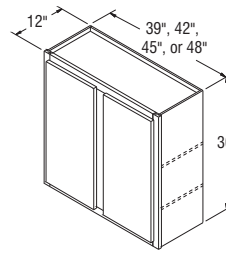

W3930
W4230
W4530
W4830

*Specify L or R on all single door Arch styles.

NOTES ✓

- ▶ Center shelf support clip included on Wall Double Door cabinets with center mullion
- ▶ Two adjustable shelves.
- ▶ Cabinets use standard natural maple interior, excluding white which has a white interior.
- ▶ Nantucket and Grayson W0930 doors utilize recessed center panels.
- ▶ All W0930 cabinets have square doors.

DESIGN SOLUTIONS

- ▶ Apply an End Panel Skin to create a flush end on the side of a Wall cabinet if installed at the end of a run for ease of Moulding installation.

Wall Cabinets, 30" High, 15" Deep

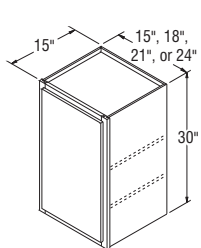

W153015*
W183015*
W213015*
W243015*

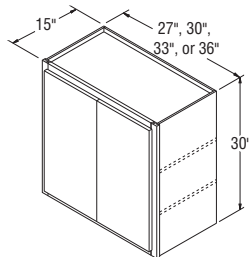

W273015B
W303015B
W333015B
W363015B

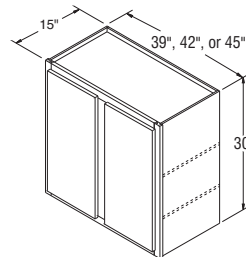

W393015
W423015
W453015

*Specify L or R on all single door Arch styles.

NOTES ✓

- ▶ Center shelf support clip included on Wall Double Door cabinets with center mullion.
- ▶ Two adjustable shelves.
- ▶ Cabinets use standard natural maple interior, excluding white which has a white interior.
- ▶ When varying heights, make sure to also vary depths to allow moulding to lie against adjacent side of cabinet.

DESIGN SOLUTIONS

- ▶ Apply an End Panel Skin to create a flush end on the side of a Wall cabinet if installed at the end of a run for ease of Moulding installation.

Wall Cabinets, 36" High, 12" Deep

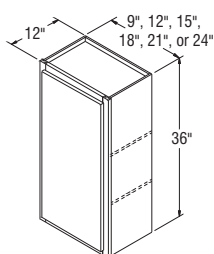

W0936
W1236*
W1536*
W1836*
W2136*
W2436*

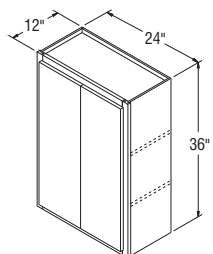

W2436DD

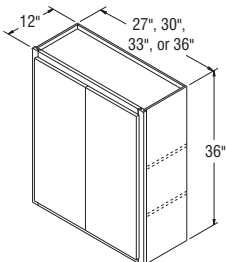

W2736B
W3036B
W3336B
W3636B

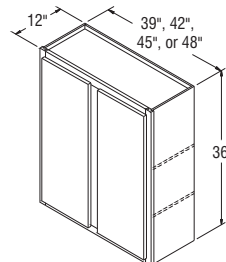

W3936
W4236
W4536
W4836

*Specify L or R on all single door Arch styles.

NOTES ✓

- ▶ Center shelf support clip included on Wall Double Door cabinets with center mullion.
- ▶ Two adjustable shelves.
- ▶ Cabinets use standard natural maple interior, excluding white which has a white interior.
- ▶ Nantucket and Grayson W0936 doors utilize recessed center panels.
- ▶ All W0936 cabinets have square doors.

DESIGN SOLUTIONS

- ▶ Apply an End Panel Skin to create a flush end on the side of a Wall cabinet if installed at the end of a run for ease of Moulding installation.

Wall Cabinets, 36" High, 15" Deep

NOTES ✓

- ▶ Center shelf support clip included on Wall Double Door cabinets with center mullion.
- ▶ Two adjustable shelves.
- ▶ Cabinets use standard natural maple interior, excluding white which has a white interior.
- ▶ When varying heights, make sure to also vary depths to allow moulding to lie against adjacent side of cabinet.

DESIGN SOLUTIONS

- ▶ Apply an End Panel Skin to create a flush end on the side of a Wall cabinet if installed at the end of a run for ease of Moulding installation.

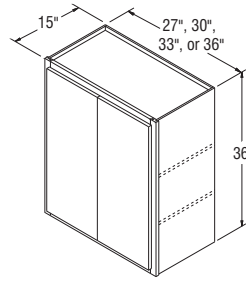
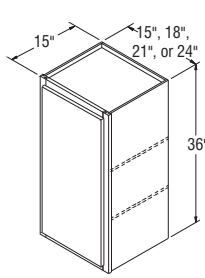

W153615*
W183615*
W213615*
W243615*

W273615B
W303615B
W333615B
W363615B

*Specify L or R on all single door Arch styles.

NOTES ✓

- ▶ Center shelf support clip included on Wall Double Door cabinets with center mullion.
- ▶ Three adjustable shelves.
- ▶ Cabinets use standard natural maple interior, excluding white which has a white interior.
- ▶ All W0942 cabinets have square doors.
- ▶ Nantucket and Grayson W0942 doors utilize recessed center panels.

DESIGN SOLUTIONS

- ▶ Apply an End Panel Skin to create a flush end on the side of a Wall cabinet if installed at the end of a run for ease of Moulding installation.

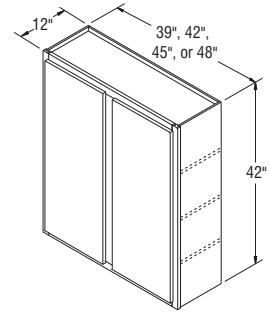
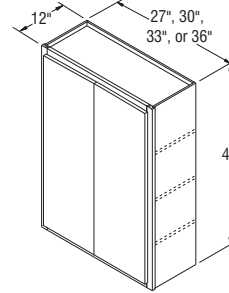
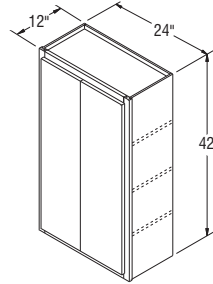
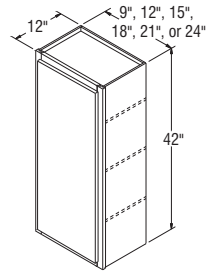

W0942
W1242*
W1542*
W1842*
W2142*
W2442*

W2442DD

W2742B
W3042B
W3342B
W3642B

W3942
W4242
W4542
W4842

*Specify L or R on all single door Arch styles.

Wall Cabinets, 42" High, 15" Deep

NOTES ✓

- ▶ Center shelf support clip included on Wall Double Door cabinets with center mullion.
- ▶ Three adjustable shelves.
- ▶ Cabinets use standard natural maple interior, excluding white which has a white interior.
- ▶ When varying heights, make sure to also vary depths to allow moulding to lie against adjacent side of cabinet.

DESIGN SOLUTIONS

- ▶ Apply an End Panel Skin to create a flush end on the side of a Wall cabinet if installed at the end of a run for ease of Moulding installation.

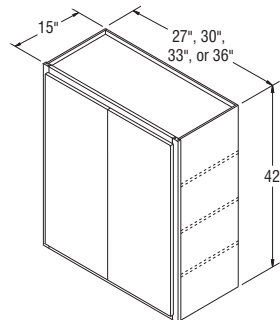
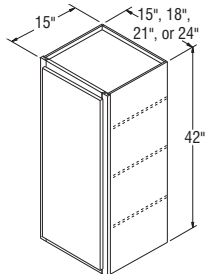

W154215*
W184215*
W214215*
W244215*

W274215B
W304215B
W334215B
W364215B

*Specify L or R on all single door Arch styles.

Wall Open Cabinets, 12" High, 12" Deep

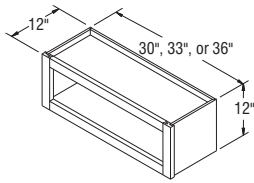

WOL3012
WOL3312
WOL3612

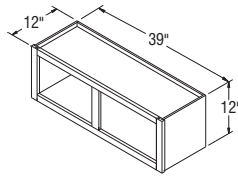

WOL3912

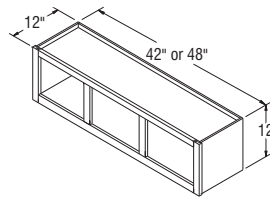

WOL4212
WOL4812

NOTES ✓

- ▶ Shelves not available in cabinets less than 24" in height.
- ▶ Cabinets include matching Aristex® interior.
- ▶ Doors can be added in the field, if desired.

DESIGN SOLUTIONS

- ▶ Apply an End Panel Skin to create a flush end on the side of a Wall cabinet if installed at the end of a run for ease of Moulding installation.

Wall Open Cabinets, 14" High, 12" Deep

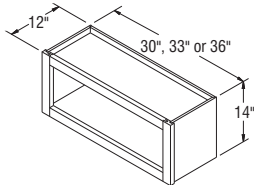

WOL3014
WOL3314
WOL3614

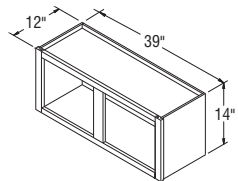

WOL3914

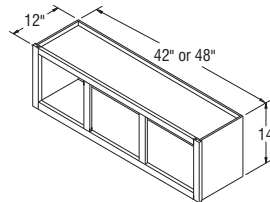

WOL4214
WOL4814

NOTES ✓

- ▶ Shelves not available in cabinets less than 24" in height.
- ▶ Cabinets include matching Aristex® interior.
- ▶ Doors can be added in the field, if desired.

DESIGN SOLUTIONS

- ▶ Apply an End Panel Skin to create a flush end on the side of a Wall cabinet if installed at the end of a run for ease of Moulding installation.

Wall Open Cabinets, 18" High, 12" Deep

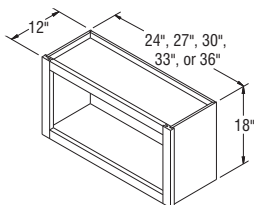

WOL2418
WOL2718
WOL3018
WOL3318
WOL3618

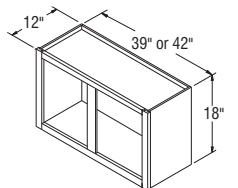

WOL3918
WOL4218

NOTES ✓

- ▶ Shelves not available in cabinets less than 24" in height.
- ▶ Cabinets include matching Aristex® interior.
- ▶ Doors can be added in the field, if desired.

DESIGN SOLUTIONS

- ▶ Apply an End Panel Skin to create a flush end on the side of a Wall cabinet if installed at the end of a run for ease of Moulding installation.

Wall Open Cabinets, 21" High, 12" Deep

NOTES ✓

- ▶ Shelves not available in cabinets less than 24" in height.
- ▶ Cabinets include matching Aristex® interior.
- ▶ Doors can be added in the field, if desired.

DESIGN SOLUTIONS

- ▶ Apply an End Panel Skin to create a flush end on the side of a Wall cabinet if installed at the end of a run for ease of Moulding installation.

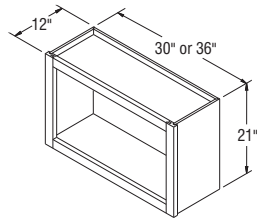

WOL3021
WOL3621

Wall Open Cabinets, 21" High, 15" Deep

NOTES ✓

- ▶ Shelves not available in cabinets less than 24" in height.
- ▶ Cabinets include matching Aristex® interior.
- ▶ Doors can be added in the field, if desired.
- ▶ When varying heights, make sure to also vary depths to allow moulding to lie against adjacent side of cabinet.

DESIGN SOLUTIONS

- ▶ Apply an End Panel Skin to create a flush end on the side of a Wall cabinet if installed at the end of a run for ease of Moulding installation.

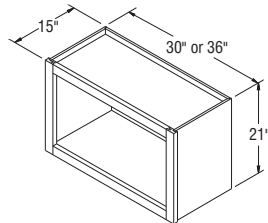

WOL302115
WOL362115

Wall Open Cabinets, 24" High, 12" Deep

NOTES ✓

- ▶ One adjustable 3/4" thick matching Aristex® shelf.
- ▶ Cabinets include matching Aristex® interior.
- ▶ Doors can be added in the field, if desired.

DESIGN SOLUTIONS

- ▶ Apply an End Panel Skin to create a flush end on the side of a Wall cabinet if installed at the end of a run for ease of Moulding installation.

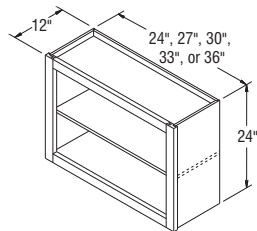

WOL2424
WOL2724
WOL3024
WOL3324
WOL3624

Wall Open Cabinets, 24" High, 15" Deep

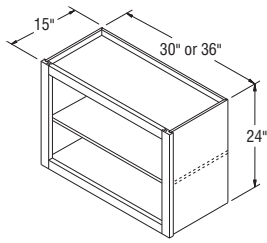

WOL302415
WOL362415

NOTES ✓

- ▶ One adjustable 3/4" thick matching Aristex® shelf.
- ▶ Cabinets include matching Aristex® interior.
- ▶ Doors can be added in the field, if desired.
- ▶ When varying heights, make sure to also vary depths to allow moulding to lie against adjacent side of cabinet.

DESIGN SOLUTIONS

- ▶ Apply an End Panel Skin to create a flush end on the side of a Wall cabinet if installed at the end of a run for ease of Moulding installation.

Wall Open Cabinets, 30" High, 12" Deep

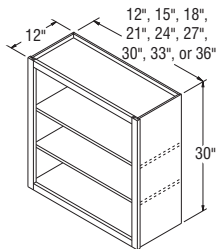

WOL1230
WOL1530
WOL1830
WOL2130
WOL2430
WOL2730
WOL3030
WOL3330
WOL3630

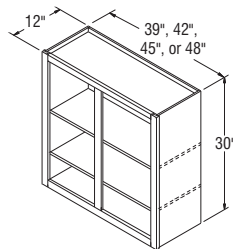

WOL3930
WOL4230
WOL4530
WOL4830

NOTES ✓

- ▶ Two adjustable 3/4" thick matching Aristex® shelves.
- ▶ Cabinets include matching Aristex® interior.
- ▶ Doors can be added in the field, if desired.

DESIGN SOLUTIONS

- ▶ Apply an End Panel Skin to create a flush end on the side of a Wall cabinet if installed at the end of a run for ease of Moulding installation.

Wall Open Cabinets, 30" High, 15" Deep

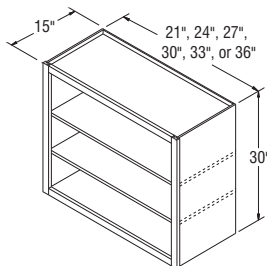

WOL213015
WOL243015
WOL273015
WOL303015
WOL333015
WOL363015

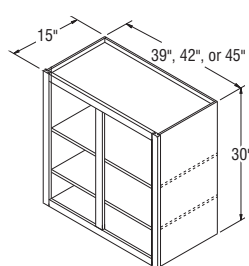

WOL393015
WOL423015
WOL453015

NOTES ✓

- ▶ Two adjustable 3/4" thick matching Aristex® shelves.
- ▶ Cabinets include matching Aristex® interior.
- ▶ Doors can be added in the field, if desired.
- ▶ When varying heights, make sure to also vary depths to allow moulding to lie against adjacent side of cabinet.

DESIGN SOLUTIONS

- ▶ Apply an End Panel Skin to create a flush end on the side of a Wall cabinet if installed at the end of a run for ease of Moulding installation.

NOTES ✓

- ▶ Two adjustable 3/4" thick matching Aristex® shelves.
- ▶ Cabinets include matching Aristex® interior.
- ▶ Doors can be added in the field, if desired.

DESIGN SOLUTIONS

- ▶ Apply an End Panel Skin to create a flush end on the side of a Wall cabinet if installed at the end of a run for ease of Moulding installation.

Wall Open Cabinets, 36" High, 12" Deep

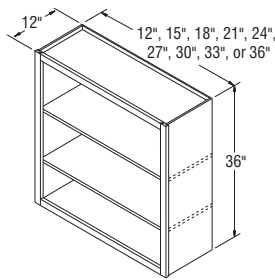

- | | |
|----------------|----------------|
| WOL1236 | WOL2736 |
| WOL1536 | WOL3036 |
| WOL1836 | WOL3336 |
| WOL2136 | WOL3636 |
| WOL2436 | |

NOTES ✓

- ▶ Two adjustable 3/4" thick matching Aristex® shelves.
- ▶ Cabinets include matching Aristex® interior.
- ▶ Doors can be added in the field, if desired.
- ▶ When varying heights, make sure to also vary depths to allow moulding to lie against adjacent side of cabinet.

DESIGN SOLUTIONS

- ▶ Apply an End Panel Skin to create a flush end on the side of a Wall cabinet if installed at the end of a run for ease of Moulding installation.

Wall Open Cabinets, 36" High, 15" Deep

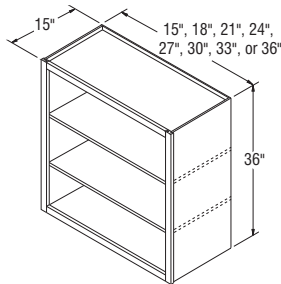

- | |
|------------------|
| WOL153615 |
| WOL183615 |
| WOL213615 |
| WOL243615 |
| WOL273615 |
| WOL303615 |
| WOL333615 |
| WOL363615 |

NOTES ✓

- ▶ Two adjustable 3/4" thick matching Aristex® shelves.
- ▶ Cabinets include matching Aristex® interior.
- ▶ Doors can be added in the field, if desired.

DESIGN SOLUTIONS

- ▶ Apply an End Panel Skin to create a flush end on the side of a Wall cabinet if installed at the end of a run for ease of Moulding installation.

Wall Open Cabinets, 42" High, 12" Deep

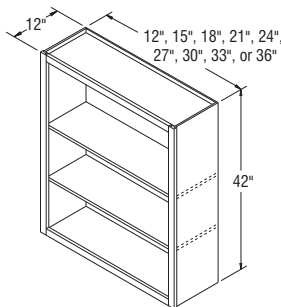

- | | |
|----------------|----------------|
| WOL1242 | WOL2742 |
| WOL1542 | WOL3042 |
| WOL1842 | WOL3342 |
| WOL2142 | WOL3642 |
| WOL2442 | |

Wall Open Cabinets, 42" High, 15" Deep

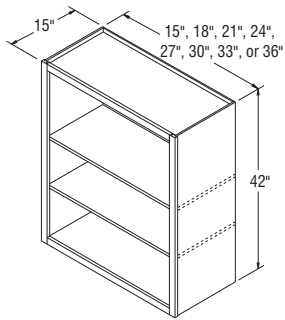

WOL154215
WOL184215
WOL214215
WOL244215
WOL274215
WOL304215
WOL334215
WOL364215

NOTES ✓

- ▶ Two adjustable ¾" thick matching Aristex® shelves.
- ▶ Cabinets include matching Aristex® shelves.
- ▶ Doors can be added in the field, if desired.
- ▶ When varying heights, make sure to also vary depths to allow moulding to lie against adjacent side of cabinet.

DESIGN SOLUTIONS

- ▶ Apply an End Panel Skin to create a flush end on the side of a Wall cabinet if installed at the end of a run for ease of Moulding installation.

Wall Cabinets with Mullion Doors, 18" High, 12" Deep

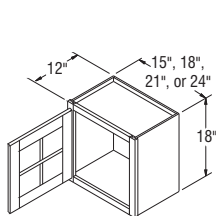

WMD1518* *New*
WMD1818* *New*
WMD2118* *New*
WMD2418*

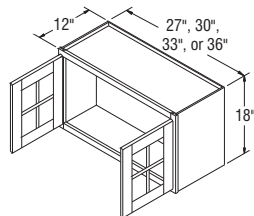

WMD2718B
WMD3018B
WMD3318B
WMD3618B

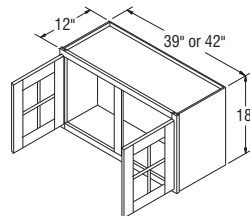

WMD3918
WMD4218

NOTES ✓

- ▶ Shelves not available in cabinets less than 24" in height.
- ▶ Cabinets include installed, clear tempered glass, and matching Aristex® interior.
- ▶ See page 29 for Standard and Shaker Mullion Door style availability and grid configurations.
- ▶ Mullion Door cabinets are not available in Brellin, Teagan, or VanWyke.

DESIGN SOLUTIONS

- ▶ Apply an End Panel Skin to create a flush end on the side of a Wall cabinet if installed at the end of a run for ease of Moulding installation.
- ▶ For complementary Wall Mullion Door cabinets in Teagan, order as Winstead Maple, as Teagan features a slab door design.

*Specify L or R on all single door Arch styles.

Wall Cabinets with Mullion Doors, 21" High, 12" Deep

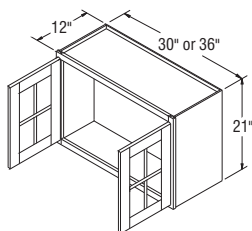

WMD3021B
WMD3621B

NOTES ✓

- ▶ Shelves not available in cabinets less than 24" in height.
- ▶ Cabinets include installed, clear tempered glass, and matching Aristex® interior.
- ▶ See page 29 for Standard and Shaker Mullion Door style availability and grid configurations.
- ▶ Mullion Door cabinets are not available in Brellin, Teagan, or VanWyke.

DESIGN SOLUTIONS

- ▶ Apply an End Panel Skin to create a flush end on the side of a Wall cabinet if installed at the end of a run for ease of Moulding installation.
- ▶ For complementary Wall Mullion Door cabinets in Teagan, order as Winstead Maple, as Teagan features a slab door design.

NOTES ✓

- ▶ Shelves not available in cabinets less than 24" in height.
- ▶ Cabinets include installed, clear tempered glass, and matching Aristex® interior.
- ▶ See page 29 for Standard and Shaker Mullion Door style availability and grid configurations.
- ▶ Mullion Door cabinets are not available in Brellin, Teagan, or VanWyke.

DESIGN SOLUTIONS

- ▶ Apply an End Panel Skin to create a flush end on the side of a Wall cabinet if installed at the end of a run for ease of Moulding installation.
- ▶ For complementary Wall Mullion Door cabinets in Teagan, order as Winstead Maple, as Teagan features a slab door design.

Wall Cabinets with Mullion Doors, 21" High, 15" Deep

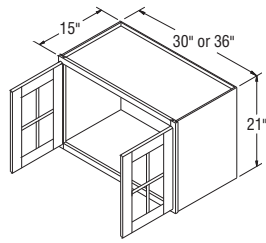

WMD302115B
WMD362115B

NOTES ✓

- ▶ One adjustable 3/4" thick matching Aristex® shelf aligns with door mullions on Standard mullions, but does not align on Shaker mullions.
- ▶ Cabinets include installed, clear tempered glass, and matching Aristex® interior.
- ▶ See page 29 for Standard and Shaker Mullion Door style availability and grid configurations.
- ▶ Mullion Door cabinets are not available in Brellin, Teagan, or VanWyke.

DESIGN SOLUTIONS

- ▶ Apply an End Panel Skin to create a flush end on the side of a Wall cabinet if installed at the end of a run for ease of Moulding installation.
- ▶ For complementary Wall Mullion Door cabinets in Teagan, order as Winstead Maple, as Teagan features a slab door design.

Wall Cabinets with Mullion Doors, 24" High, 12" Deep

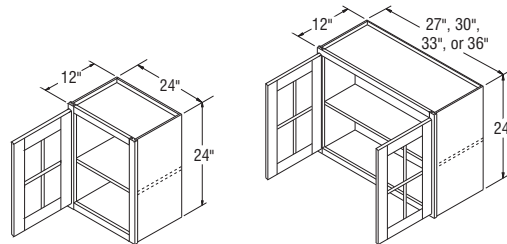

WMD2424*

WMD2724B
WMD3024B
WMD3324B
WMD3624B

*Specify L or R on all single door Arch styles.

NOTES ✓

- ▶ One adjustable 3/4" thick matching Aristex® shelf aligns with door mullions on Standard mullions, but does not align on Shaker mullions.
- ▶ Cabinets include installed, clear tempered glass, and matching Aristex® interior.
- ▶ See page 29 for Standard and Shaker Mullion Door style availability and grid configurations.
- ▶ Mullion Door cabinets are not available in Brellin, Teagan, or VanWyke.

DESIGN SOLUTIONS

- ▶ Apply an End Panel Skin to create a flush end on the side of a Wall cabinet if installed at the end of a run for ease of Moulding installation.
- ▶ For complementary Wall Mullion Door cabinets in Teagan, order as Winstead Maple, as Teagan features a slab door design.

Wall Cabinets with Mullion Doors, 24" High, 15" Deep

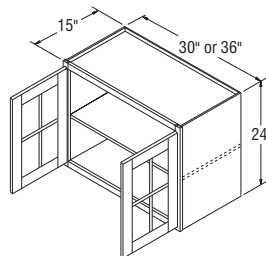

WMD302415B
WMD362415B

Wall Cabinets with Mullion Doors, 30" High, 12" Deep

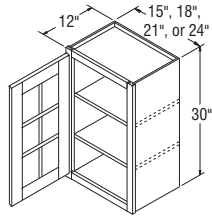

WMD1530*
WMD1830*
WMD2130*
WMD2430*

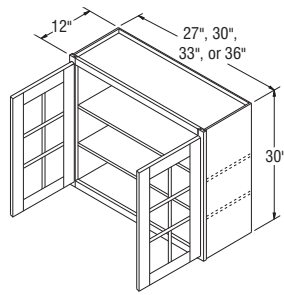

WMD2730B
WMD3030B
WMD3330B
WMD3630B

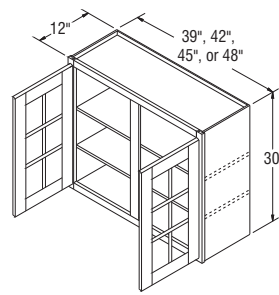

WMD3930
WMD4230
WMD4530
WMD4830

*Specify L or R on all single door Arch styles.

NOTES ✓

- ▶ Two adjustable 3/4" thick matching Aristex® shelves align with door mullions on Standard mullions, but do not align on Shaker mullions.
- ▶ Cabinets include installed, clear tempered glass and matching Aristex® interior.
- ▶ See page 29 for Standard and Shaker Mullion Door style availability and grid configurations.
- ▶ Mullion Door cabinets are not available in Brellin, Teagan, or VanWyke.

DESIGN SOLUTIONS

- ▶ Apply an End Panel Skin to create a flush end on the side of a Wall cabinet if installed at the end of a run for ease of Moulding installation.
- ▶ For complementary Wall Mullion Door cabinets in Teagan, order as Winstead Maple, as Teagan features a slab door design.

Wall Cabinets with Mullion Doors, 30" High, 15" Deep

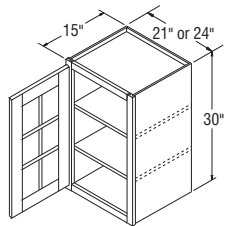

WMD213015*
WMD243015*

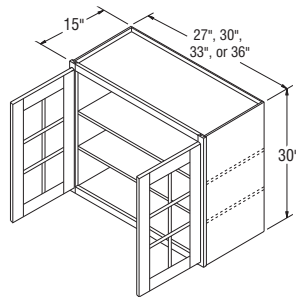

WMD273015B
WMD303015B
WMD333015B
WMD363015B

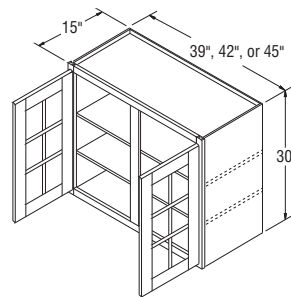

WMD393015
WMD423015
WMD453015

*Specify L or R on all single door Arch styles.

NOTES ✓

- ▶ Two adjustable 3/4" thick matching Aristex® shelves align with door mullions on Standard mullions, but do not align on Shaker mullions.
- ▶ Cabinets include installed, clear tempered glass, and matching Aristex® interior.
- ▶ See page 29 for Standard and Shaker Mullion Door style availability and grid configurations.
- ▶ Mullion Door cabinets are not available in Brellin, Teagan, or VanWyke.

DESIGN SOLUTIONS

- ▶ Apply an End Panel Skin to create a flush end on the side of a Wall cabinet if installed at the end of a run for ease of Moulding installation.
- ▶ For complementary Wall Mullion Door cabinets in Teagan, order as Winstead Maple, as Teagan features a slab door design.

NOTES ✓

- ▶ Two adjustable 3/4" thick matching Aristex® shelves align with door mullions on Standard mullions, but do not align on Shaker mullions.
- ▶ Cabinets include installed, clear tempered glass and matching Aristex® interior.
- ▶ See page 29 for Standard and Shaker Mullion Door style availability and grid configurations.
- ▶ Mullion Door cabinets are not available in Brellin, Teagan, or VanWyke.

DESIGN SOLUTIONS

- ▶ Apply an End Panel Skin to create a flush end on the side of a Wall cabinet if installed at the end of a run for ease of Moulding installation.
- ▶ For complementary Wall Mullion Door cabinets in Teagan, order as Winstead Maple, as Teagan features a slab door design.

Wall Cabinets with Mullion Doors, 36" High, 12" Deep

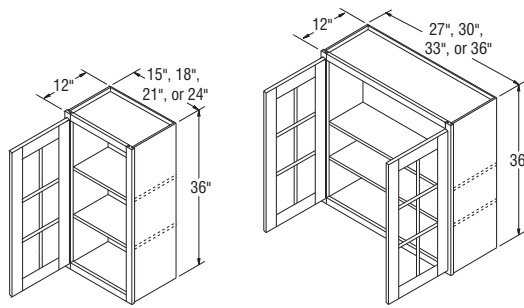

WMD1536*
WMD1836*
WMD2136*
WMD2436*

WMD2736B
WMD3036B
WMD3336B
WMD3636B

*Specify L or R on all single door Arch styles.

NOTES ✓

- ▶ Two adjustable 3/4" thick matching Aristex® shelves align with door mullions on Standard mullions, but do not align on Shaker mullions.
- ▶ Cabinets include installed, clear tempered glass, and matching Aristex® interior.
- ▶ See page 29 for Standard and Shaker Mullion Door style availability and grid configurations.
- ▶ Mullion Door cabinets are not available in Brellin, Teagan, or VanWyke.

DESIGN SOLUTIONS

- ▶ Apply an End Panel Skin to create a flush end on the side of a Wall cabinet if installed at the end of a run for ease of Moulding installation.
- ▶ For complementary Wall Mullion Door cabinets in Teagan, order as Winstead Maple, as Teagan features a slab door design.

Wall Cabinets with Mullion Doors, 36" High, 15" Deep

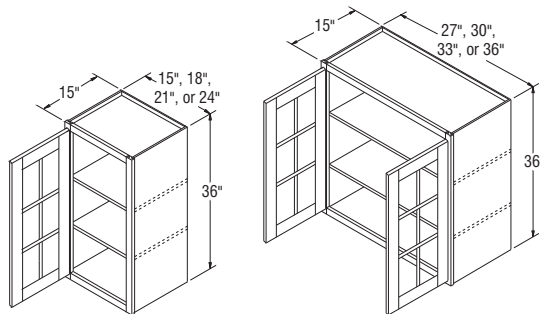

WMD153615*
WMD183615*
WMD213615*
WMD243615*

WMD273615B
WMD303615B
WMD333615B
WMD363615B

*Specify L or R on all single door Arch styles.

Wall Cabinets with Mullion Doors, 42" High, 12" Deep

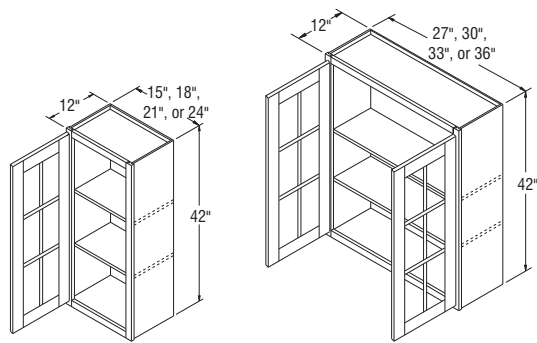

WMD1542*
WMD1842*
WMD2142*
WMD2442*

WMD2742B
WMD3042B
WMD3342B
WMD3642B

*Specify L or R on all single door Arch styles.

NOTES ✓

- ▶ Two adjustable ¾" thick matching Aristex® shelves align with door mullions on Standard mullions, but do not align on Shaker mullions.
- ▶ Cabinets include installed, clear tempered glass and matching Aristex® interior.
- ▶ See page 29 for Standard and Shaker Mullion Door style availability and grid configurations.
- ▶ Mullion Door cabinets are not available in Brellin, Teagan, or VanWyke.

DESIGN SOLUTIONS

- ▶ Apply an End Panel Skin to create a flush end on the side of a Wall cabinet if installed at the end of a run for ease of Moulding installation.
- ▶ For complementary Wall Mullion Door cabinets in Teagan, order as Winstead Maple, as Teagan features a slab door design.

Wall Cabinets with Mullion Doors, 42" High, 15" Deep

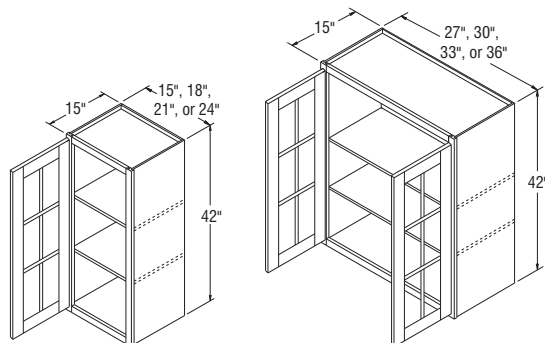

WMD154215*
WMD184215*
WMD214215*
WMD244215*

WMD274215B
WMD304215B
WMD334215B
WMD364215B

*Specify L or R on all single door Arch styles.

NOTES ✓

- ▶ Two adjustable ¾" thick matching Aristex® shelves align with door mullions on Standard mullions, but do not align on Shaker mullions.
- ▶ Cabinets include installed, clear tempered glass, and matching Aristex® interior.
- ▶ See page 29 for Standard and Shaker Mullion Door style availability and grid configurations.
- ▶ Mullion Door cabinets are not available in Brellin, Teagan, or VanWyke.

DESIGN SOLUTIONS

- ▶ Apply an End Panel Skin to create a flush end on the side of a Wall cabinet if installed at the end of a run for ease of Moulding installation.
- ▶ For complementary Wall Mullion Door cabinets in Teagan, order as Winstead Maple, as Teagan features a slab door design.

NOTES ✓

- ▶ Shelves not available in cabinets less than 24" in height.
- ▶ Cabinets include matching Aristex® interior and clips to install glass (glass not included).
- ▶ Wall Prepped for Glass cabinets are not available in Augusta, Nantucket, Teagan, or VanWyke.
- ▶ Center door on WPG4212 and WPG4812 will be hinged on the left.
- ▶ Doors Only for WPG cabinets can be ordered to meet the need for Doors Cut for Glass.

DESIGN SOLUTIONS

- ▶ Apply an End Panel Skin to create a flush end on the side of a Wall cabinet if installed at the end of a run for ease of Moulding installation.
- ▶ For complementary Wall Prepped for Glass cabinets in Teagan, order as Winstead Maple, as Teagan features a slab door design.

Wall Cabinets with Doors Prepped for Glass, 12" High, 12" Deep

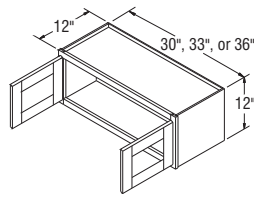

WPG3012B
WPG3312B
WPG3612B

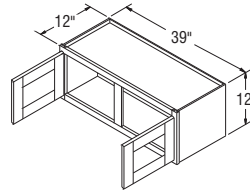

WPG3912

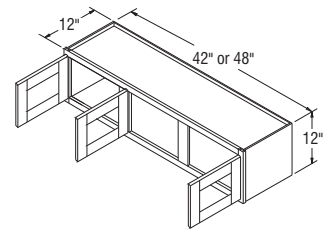

WPG4212
WPG4812

NOTES ✓

- ▶ Shelves not available in cabinets less than 24" in height.
- ▶ Cabinets include matching Aristex® interior and clips to install glass (glass not included).
- ▶ Wall Prepped for Glass cabinets are not available in Augusta, Nantucket, Teagan, or VanWyke.
- ▶ Center door on WPG4214 and WPG4814 will be hinged on the left.
- ▶ Doors Only for WPG cabinets can be ordered to meet the need for Doors Cut for Glass.

DESIGN SOLUTIONS

- ▶ Apply an End Panel Skin to create a flush end on the side of a Wall cabinet if installed at the end of a run for ease of Moulding installation.
- ▶ For complementary Wall Prepped for Glass cabinets in Teagan, order as Winstead Maple, as Teagan features a slab door design.

Wall Cabinets with Doors Prepped for Glass, 14" High, 12" Deep

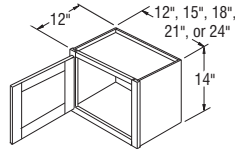

WPG1214* *New*
WPG1514* *New*
WPG1814* *New*
WPG2114* *New*
WPG2414* *New*

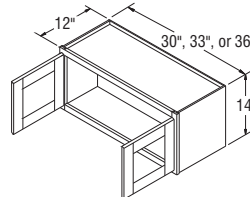

WPG3014B
WPG3314B
WPG3614B

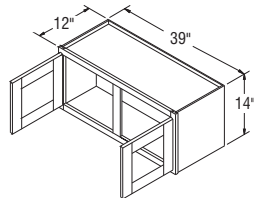

WPG3914

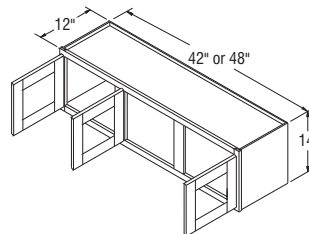

WPG4214
WPG4814

*Specify L or R on all single door Arch styles.

Wall Cabinets with Doors Prepped for Glass, 18" High, 12" Deep

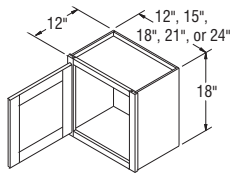

WPG1218* *New*
WPG1518* *New*
WPG1818* *New*
WPG2118* *New*
WPG2418*

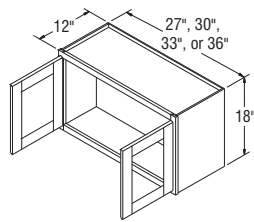

WPG2718B
WPG3018B
WPG3318B
WPG3618B

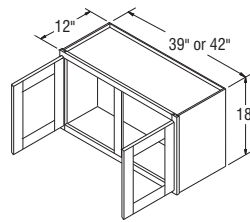

WPG3918
WPG4218

*Specify L or R on all single door Arch styles.

NOTES ✓

- ▶ Shelves not available in cabinets less than 24" in height.
- ▶ Cabinets include matching Aristex® interior and clips to install glass (glass not included).
- ▶ Wall Prepped for Glass cabinets are not available in Augusta, Nantucket, Teagan, or VanWyke.
- ▶ Doors Only for WPG cabinets can be ordered to meet the need for Doors Cut for Glass.

DESIGN SOLUTIONS

- ▶ Apply an End Panel Skin to create a flush end on the side of a Wall cabinet if installed at the end of a run for ease of Moulding installation.
- ▶ For complementary Wall Prepped for Glass cabinets in Teagan, order as Winstead Maple, as Teagan features a slab door design.

Wall Cabinets with Doors Prepped for Glass, 21" High, 12" Deep

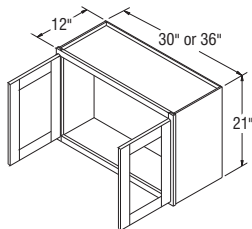

WPG3021B
WPG3621B

NOTES ✓

- ▶ Cabinets include matching Aristex® interior and clips to install glass (glass not included).
- ▶ Wall Prepped for Glass cabinets are not available in Augusta, Nantucket, Teagan, or VanWyke.
- ▶ Doors Only for WPG cabinets can be ordered to meet the need for Doors Cut for Glass.
- ▶ Doors Only for WPG cabinets can be ordered to meet the need for Doors Cut for Glass.

DESIGN SOLUTIONS

- ▶ Apply an End Panel Skin to create a flush end on the side of a Wall cabinet if installed at the end of a run for ease of Moulding installation.
- ▶ For complementary Wall Prepped for Glass cabinets in Teagan, order as Winstead Maple, as Teagan features a slab door design.

Wall Cabinets with Doors Prepped for Glass, 21" High, 15" Deep

NOTES ✓

- ▶ Shelves not available in cabinets less than 24" in height.
- ▶ Cabinets include matching Aristex® interior and clips to install glass (glass not included).
- ▶ Wall Prepped for Glass cabinets are not available in Augusta, Nantucket, Teagan, or VanWyke.
- ▶ Doors Only for WPG cabinets can be ordered to meet the need for Doors Cut for Glass.

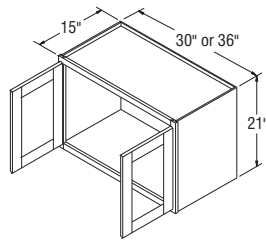

WPG302115B
WPG362115B

DESIGN SOLUTIONS

- ▶ Apply an End Panel Skin to create a flush end on the side of a Wall cabinet if installed at the end of a run for ease of Moulding installation.
- ▶ For complementary Wall Prepped for Glass cabinets in Teagan, order as Winstead Maple, as Teagan features a slab door design.

Wall Cabinets with Doors Prepped for Glass, 24" High, 12" Deep

NOTES ✓

- ▶ Cabinets include matching Aristex® interior, one adjustable 3/4" thick matching Aristex® shelf, and clips to install glass (glass not included).
- ▶ Wall Prepped for Glass cabinets are not available in Augusta, Nantucket, Teagan, or VanWyke.
- ▶ Doors Only for WPG cabinets can be ordered to meet the need for Doors Cut for Glass.

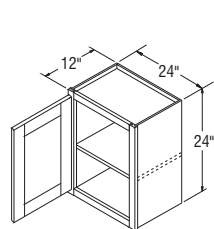

WPG2424*

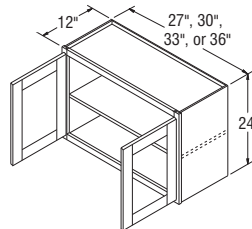

WPG2724B
WPG3024B
WPG3324B
WPG3624B

DESIGN SOLUTIONS

- ▶ Apply an End Panel Skin to create a flush end on the side of a Wall cabinet if installed at the end of a run for ease of Moulding installation.
- ▶ For complementary Wall Prepped for Glass cabinets in Teagan, order as Winstead Maple, as Teagan features a slab door design.

*Specify L or R on all single door Arch styles.

Wall Cabinets with Doors Prepped for Glass, 24" High, 15" Deep

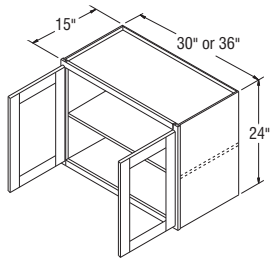

WPG302415B
WPG362415B

NOTES ✓

- ▶ Cabinets include matching Aristex® interior, two adjustable 3/4" thick matching Aristex® shelves, and clips to install glass (glass not included).
- ▶ Wall Prepped for Glass cabinets are not available in Augusta, Nantucket, Teagan, or VanWyke.
- ▶ Doors Only for WPG cabinets can be ordered to meet the need for Doors Cut for Glass.

DESIGN SOLUTIONS

- ▶ Apply an End Panel Skin to create a flush end on the side of a Wall cabinet if installed at the end of a run for ease of Moulding installation.
- ▶ For complementary Wall Prepped for Glass cabinets in Teagan, order as Winstead Maple, as Teagan features a slab door design.

Wall Cabinets with Doors Prepped for Glass, 30" High, 12" Deep

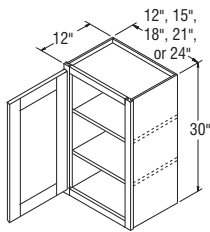

WPG1230*
WPG1530*
WPG1830*
WPG2130*
WPG2430*

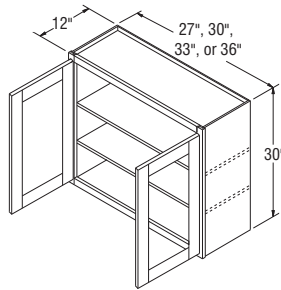

WPG2730B
WPG3030B
WPG3330B
WPG3630B

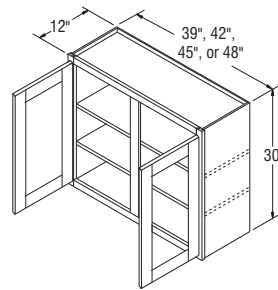

WPG3930
WPG4230
WPG4530
WPG4830

NOTES ✓

- ▶ Cabinets include matching Aristex® interior, two adjustable 3/4" thick matching Aristex® shelves, and clips to install glass (glass not included).
- ▶ Wall Prepped for Glass cabinets are not available in Augusta, Nantucket, Teagan, or VanWyke.
- ▶ Doors Only for WPG cabinets can be ordered to meet the need for Doors Cut for Glass.

DESIGN SOLUTIONS

- ▶ Apply an End Panel Skin to create a flush end on the side of a Wall cabinet if installed at the end of a run for ease of Moulding installation.
- ▶ For complementary Wall Prepped for Glass cabinets in Teagan, order as Winstead Maple, as Teagan features a slab door design.

*Specify L or R on all single door Arch styles.

Wall Cabinets with Doors Prepped for Glass, 30" High, 15" Deep

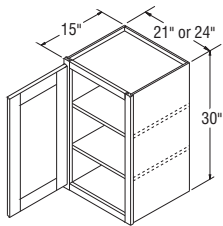

WPG213015*
WPG243015*

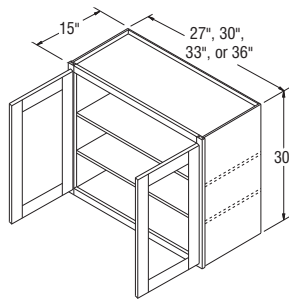

WPG273015B
WPG303015B
WPG333015
WPG363015B

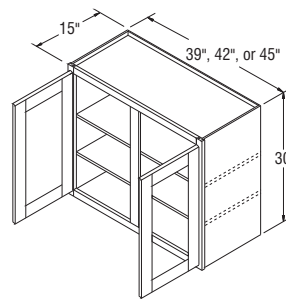

WPG393015
WPG423015
WPG453015

NOTES ✓

- ▶ Cabinets include matching Aristex® interior, two adjustable 3/4" thick matching Aristex® shelves, and clips to install glass (glass not included).
- ▶ Wall Prepped for Glass cabinets are not available in Augusta, Nantucket, Teagan, or VanWyke.
- ▶ Doors Only for WPG cabinets can be ordered to meet the need for Doors Cut for Glass.

DESIGN SOLUTIONS

- ▶ Apply an End Panel Skin to create a flush end on the side of a Wall cabinet if installed at the end of a run for ease of Moulding installation.
- ▶ For complementary Wall Prepped for Glass cabinets in Teagan, order as Winstead Maple, as Teagan features a slab door design.

*Specify L or R on all single door Arch styles.

Wall Cabinets with Doors Prepped for Glass, 36" High, 12" Deep

NOTES ✓

- ▶ Cabinets include matching Aristex® interior, two adjustable ¾" thick matching Aristex® shelves, and clips to install glass (glass not included).
- ▶ Wall Prepped for Glass cabinets are not available in Augusta, Nantucket, Teagan, or VanWyke.
- ▶ Doors Only for WPG cabinets can be ordered to meet the need for Doors Cut for Glass.

DESIGN SOLUTIONS

- ▶ Apply an End Panel Skin to create a flush end on the side of a Wall cabinet if installed at the end of a run for ease of Moulding installation.
- ▶ For complementary Wall Prepped for Glass cabinets in Teagan, order as Winstead Maple, as Teagan features a slab door design.

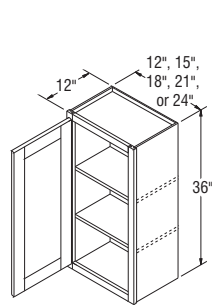

WPG1236*
WPG1536*
WPG1836*
WPG2136*
WPG2436*

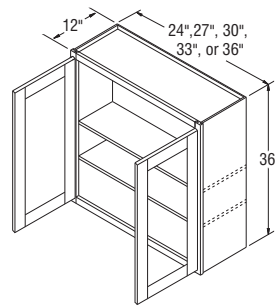

WPG2436DD
WPG2736B
WPG3036B
WPG3336B
WPG3636B

*Specify L or R on all single door Arch styles.

Wall Cabinets with Doors Prepped for Glass, 36" High, 15" Deep

NOTES ✓

- ▶ Cabinets include matching Aristex® interior, two adjustable ¾" thick matching Aristex® shelves, and clips to install glass (glass not included).
- ▶ Wall Prepped for Glass cabinets are not available in Augusta, Nantucket, Teagan, or VanWyke.
- ▶ Doors Only for WPG cabinets can be ordered to meet the need for Doors Cut for Glass.

DESIGN SOLUTIONS

- ▶ Apply an End Panel Skin to create a flush end on the side of a Wall cabinet if installed at the end of a run for ease of Moulding installation.
- ▶ For complementary Wall Prepped for Glass cabinets in Teagan, order as Winstead Maple, as Teagan features a slab door design.

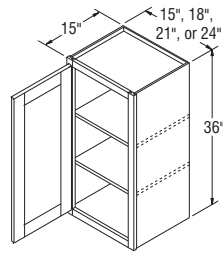

WPG153615*
WPG183615*
WPG213615*
WPG243615*

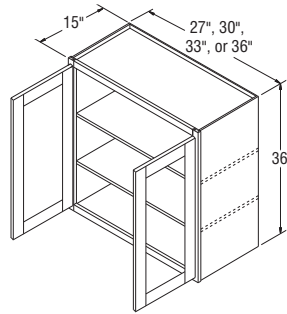

WPG273615B
WPG303615B
WPG333615B
WPG363615B

*Specify L or R on all single door Arch styles.

Wall Cabinets with Doors Prepped for Glass, 42" High, 12" Deep

NOTES ✓

- ▶ Cabinets include matching Aristex® interior, two adjustable ¾" thick matching Aristex® shelves, and clips to install glass (glass not included).
- ▶ Wall Prepped for Glass cabinets are not available in Augusta, Nantucket, Teagan, or VanWyke.
- ▶ Doors Only for WPG cabinets can be ordered to meet the need for Doors Cut for Glass.

DESIGN SOLUTIONS

- ▶ Apply an End Panel Skin to create a flush end on the side of a Wall cabinet if installed at the end of a run for ease of Moulding installation.
- ▶ For complementary Wall Prepped for Glass cabinets in Teagan, order as Winstead Maple, as Teagan features a slab door design.

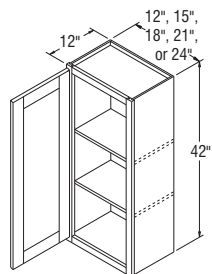

WPG1242*
WPG1542*
WPG1842*
WPG2142*
WPG2442*

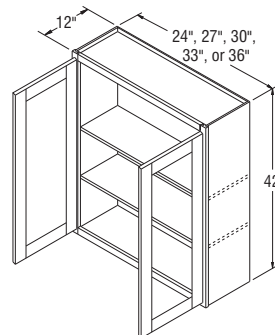

WPG2442DD
WPG2742B
WPG3042B
WPG3342B
WPG3642B

*Specify L or R on all single door Arch styles.

Wall Cabinets with Doors Prepped for Glass, 42" High, 15" Deep

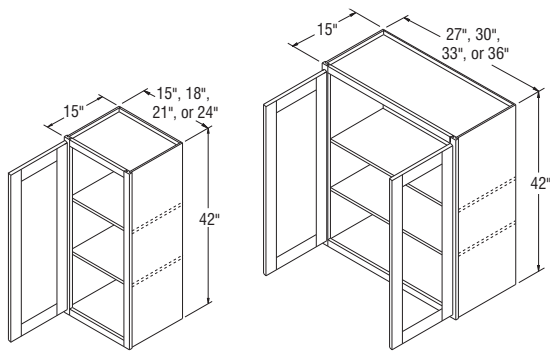

WPG154215*
WPG184215*
WPG214215*
WPG244215*

WPG274215B
WPG304215B
WPG334215B
WPG364215B

*Specify L or R on all single door Arch styles.

NOTES ✓

- ▶ Cabinets include matching Aristex® interior, two adjustable ¾" thick matching Aristex® shelves, and clips to install glass (glass not included).
- ▶ Wall Prepped for Glass cabinets are not available in Augusta, Nantucket, Teagan, or VanWyke.
- ▶ Doors Only for WPG cabinets can be ordered to meet the need for Doors Cut for Glass.

DESIGN SOLUTIONS

- ▶ Apply an End Panel Skin to create a flush end on the side of a Wall cabinet if installed at the end of a run for ease of Moulding installation.
- ▶ For complementary Wall Prepped for Glass cabinets in Teagan, order as Winstead Maple, as Teagan features a slab door design.

Refrigerator Wall Cabinets, 12" High, 23 ¾" Deep

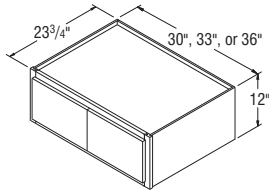

RW3012B
RW3312B
RW3612B

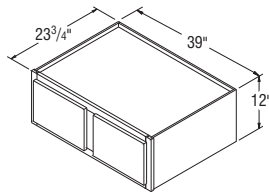

RW3912

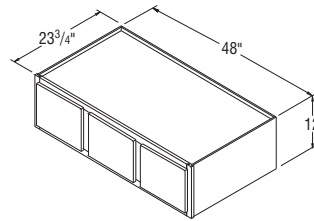

RW4812

NOTES ✓

- ▶ Shelves not available in cabinets less than 24" in height.
- ▶ Cabinets use standard natural maple interior, excluding white which has a white interior.
- ▶ Cabinets must be supported on three surfaces when mounted.
- ▶ Center door on RW4812 will be hinged on the left.
- ▶ When designing for built-in refrigerators, be sure to use necessary Fillers to provide proper clearance.

DESIGN SOLUTIONS

- ▶ Apply an End Panel Skin to create a flush end on the side of a Wall cabinet if installed at the end of a run for ease of Moulding installation.

Refrigerator Wall Cabinets, 14" High, 23 ¾" Deep

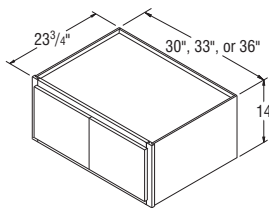

RW3014B
RW3314B
RW3614B

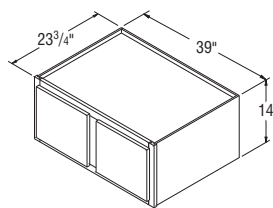

RW3914

NOTES ✓

- ▶ Shelves not available in cabinets less than 24" in height.
- ▶ Cabinets use standard natural maple interior, excluding white which has a white interior.
- ▶ Cabinets must be supported on three surfaces when mounted.
- ▶ When designing for built-in refrigerators, be sure to use necessary Fillers to provide proper clearance.

DESIGN SOLUTIONS

- ▶ Apply an End Panel Skin to create a flush end on the side of a Wall cabinet if installed at the end of a run for ease of Moulding installation.

Refrigerator Wall Cabinets, 18" High, 23 3/4" Deep

NOTES ✓

- ▶ Shelves not available in cabinets less than 24" in height.
- ▶ Cabinets use standard natural maple interior, excluding white which has a white interior.
- ▶ Cabinets must be supported on three surfaces when mounted.
- ▶ When designing for built-in refrigerators, be sure to use necessary Fillers to provide proper clearance.

DESIGN SOLUTIONS

- ▶ Apply an End Panel Skin to create a flush end on the side of a Wall cabinet if installed at the end of a run for ease of Moulding installation.

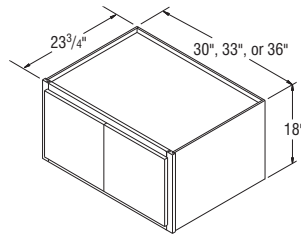

RW3018B
RW3318B
RW3618B

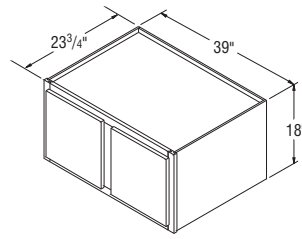

RW3918

Refrigerator Wall Cabinets, 21" High, 23 3/4" Deep

NOTES ✓

- ▶ Shelves not available in cabinets less than 24" in height.
- ▶ Cabinets use standard natural maple interior, excluding white which has a white interior.
- ▶ Cabinets must be supported on three surfaces when mounted.
- ▶ When designing for built-in refrigerators, be sure to use necessary Fillers to provide proper clearance.

DESIGN SOLUTIONS

- ▶ Apply an End Panel Skin to create a flush end on the side of a Wall cabinet if installed at the end of a run for ease of Moulding installation.

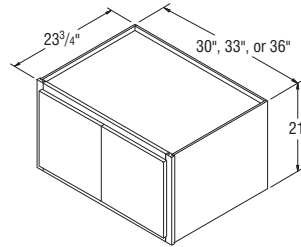

RW3021B
RW3321B
RW3621B

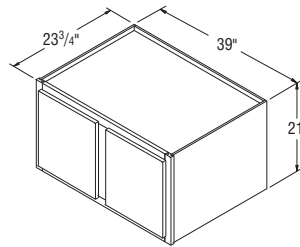

RW3921

Refrigerator Wall Cabinets, 24" High, 23 3/4" Deep

NOTES ✓

- ▶ Shelves not included.
- ▶ Cabinets use standard natural maple interior, excluding white which has a white interior.
- ▶ Cabinets must be supported on three surfaces when mounted.
- ▶ When designing for built-in refrigerators, be sure to use necessary Fillers to provide proper clearance.

DESIGN SOLUTIONS

- ▶ Apply an End Panel Skin to create a flush end on the side of a Wall cabinet if installed at the end of a run for ease of Moulding installation.

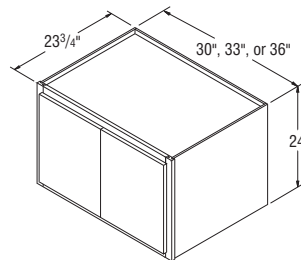

RW3024B
RW3324B
RW3624B

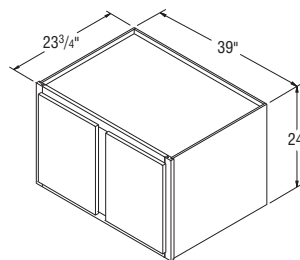

RW3924

Wine Rack Cabinets, 12" Deep

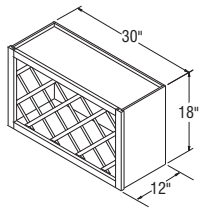

WR3018

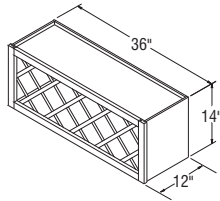

WR3614

NOTES ✓

- ▶ Matching Aristex® interior.
- ▶ Can be installed horizontally or vertically.
- ▶ When installed vertically, wine rack can't be used as the end cabinet because the ends are recessed. Frame rail configuration will be unique from adjacent cabinets when installed vertically.
- ▶ WR3018 holds 11 bottles.
- ▶ WR3614 holds 13 bottles.
- ▶ Wine bottles may extend beyond face frame. Not recommended for high traffic areas.

DESIGN SOLUTIONS

- ▶ Apply an End Panel Skin to create a flush end on the side of a Wall cabinet if installed at the end of a run for ease of Moulding installation.



Wall Plate Rack Cabinets, 18" High, 30" Wide, 12" Deep

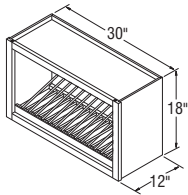

WPR3018

NOTES ✓

- ▶ Matching Aristex® interior.
- ▶ Holds 14 plates.

DESIGN SOLUTIONS

- ▶ Apply an End Panel Skin to create a flush end on the side of a Wall cabinet if installed at the end of a run for ease of Moulding installation.



NOTES ✓

- ▶ Cabinets use standard natural maple interior, excluding white which has a white interior.
- ▶ Drawer guides are side-mount Full Extension.
- ▶ Dovetail drawer not available.
- ▶ Outside edge profile will match door.
- ▶ In countertop applications, backsplash must be cut out for flush installation against a wall.

Wall Drawer Unit, 17 1/2" High, 18" Wide, 12" Deep

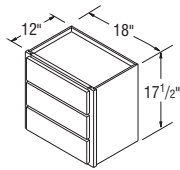

WD1817.5

DESIGN SOLUTIONS

- ▶ Apply an End Panel Skin to create a flush end on the side of a Wall cabinet if installed at the end of a run for ease of Moulding installation.



NOTES ✓

- ▶ Cabinets include magnetic white board on back of door, key hooks, pencil holder, and fixed plexiglass-fronted 3/4" thick shelves.
- ▶ For proper installation, adjacent cabinet must have 1/4" panel applied, not included with WMC.
- ▶ Cabinet will have flush plywood ends to allow for application of Overlays or Split Turnings.

Wall Message Center Cabinets, 12" Wide, 3" Deep

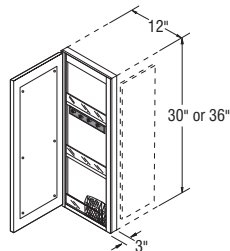

WMC1230*
WMC1236*

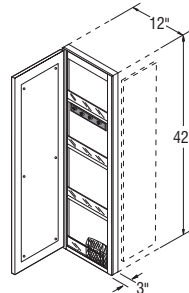

WMC1242*

*Specify L or R on all styles. Cabinet should be hinged on wall side.



Microwave Wall Cabinets, 36" High, 30" Wide, 12" Deep

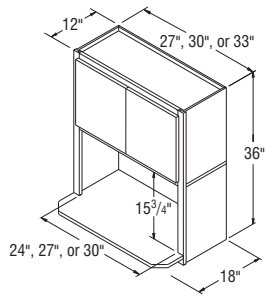

MWC2736B
MWC3036B
MWC3336B

NOTES ✓

- ▶ One fixed shelf for microwave and one fixed shelf for upper section.
- ▶ Bottom shelf ships loose, includes standard shelf clips.
- ▶ Matching Aristex® interior throughout cabinet.
- ▶ Two doors.
- ▶ Cannot be installed next to Diagonal Wall cabinets.
- ▶ When using with 30" Wall cabinets, the MWC3036 will hang 6" below the Wall cabinet line.
- ▶ Designed for free-standing microwaves.
- ▶ Cabinet must be supported on both sides. Not intended for end of run.

Microwave Wall Cabinets, 48" High, 30" Wide, 12" Deep

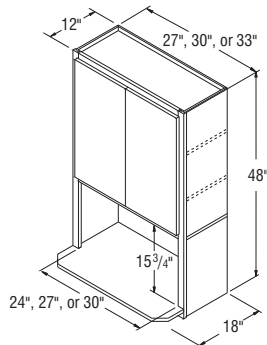

MWC3048B
MWC3048B
MWC3348B

NOTES ✓

- ▶ Two adjustable 3/4" shelves, one fixed shelf for microwave (bottom shelf ships loose, includes standard shelf clips), and one fixed shelf for upper section.
- ▶ Matching Aristex® interior throughout cabinet
- ▶ Two doors.
- ▶ Cannot be installed next to Diagonal Wall cabinets.
- ▶ When using with 42" Wall cabinets, the MWC3048 will hang 6" below the Wall cabinet line.
- ▶ Designed for free-standing microwaves.
- ▶ Cabinet must be supported on both sides. Not intended for end of run.



NOTES ✓

- ▶ Matching Aristex® interior throughout cabinet.
- ▶ Microwave opening is trimmable.
- ▶ Minimum opening – 27" W x 16½" H. Maximum opening – 27" W x 20½" H.
- ▶ Designed for built-in microwaves with trim kits.
- ▶ Cabinet must be supported on both sides. Not intended for end of run.



Wall Built-In Microwave Cabinets, 36" High, 30" Wide, 21" Deep

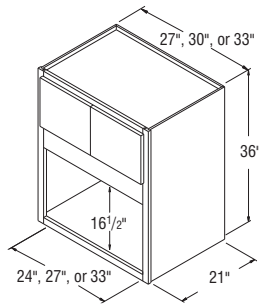

- MWC273621B**
- MWC303621B**
- MWC333621B**

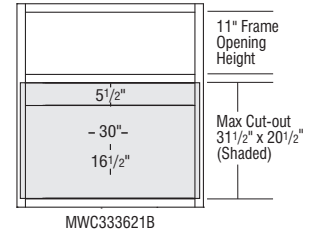
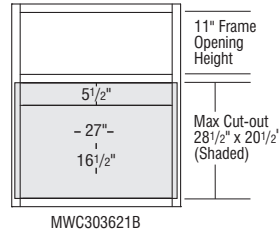
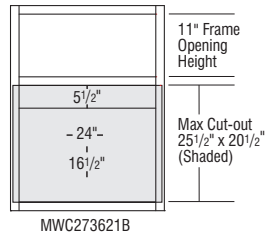

NOTES ✓

- ▶ Matching Aristex® interior throughout cabinet.
- ▶ Microwave opening is trimmable.
- ▶ Minimum opening – 27" W x 16½" H. Maximum opening – 27" W x 20½" H.
- ▶ Designed for built-in microwaves with trim kits.
- ▶ Cabinet must be supported on both sides. Not intended for end of run.



Wall Built-In Microwave Cabinets, 42" High, 30" Wide, 21" Deep

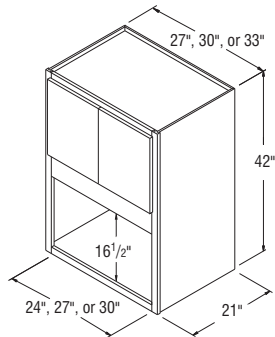

- MWC274221B**
- MWC304221B**
- MWC334221B**

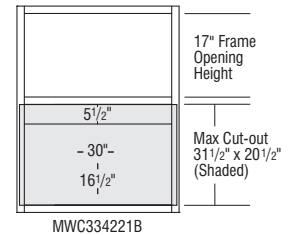
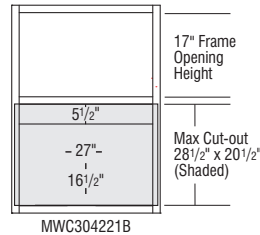
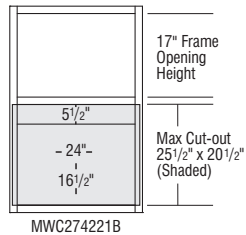

Microwave Wall Open Shelf, 18" Deep *New*

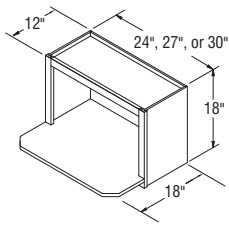

MWOL2418
MWOL2718
MWOL3018

NOTES ✓

- ▶ Shelf extends an additional 2½".
- ▶ Matching Aristex® interior.
- ▶ Cabinet must be supported on both sides. Not intended for end of run.



Wine Cubes, 12" Deep

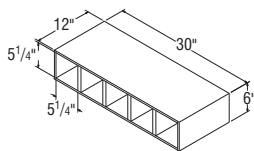

(5 openings)

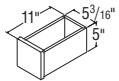

(includes 5 drawers)

WCUBE30
WCUBEDRW5

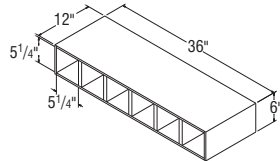

(6 openings)

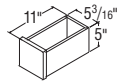

(includes 6 drawers)

WCUBE36
WCUBEDRW6

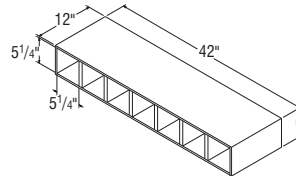

(7 openings)

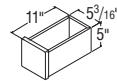

(includes 7 drawers)

WCUBE42
WCUBEDRW7

NOTES ✓

- ▶ Matching veneered finish interior.
- ▶ WCUBE may be positioned horizontally or vertically.
- ▶ WCUBEDRW features four-sided drawer boxes, no slides required. Does not include decorative hardware on any style.



What-Not Shelves, 30" , 36" , and 42" High, 12" Wide, 5" Deep

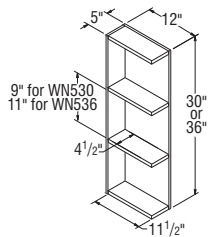

WN530
WN536

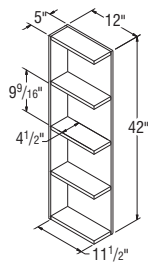

WN542

NOTES ✓

- ▶ Matching veneered finish interior.



Canopy Wood Hoods, Arch, 30" and 36" Wide, 24" High

NOTES ✓

- ▶ Butt door styles will utilize butt door sizes, frame will always have a 3" center mullion.
- ▶ Install Wood Hoods between adjoining 12" deep cabinets (15" deep cabinets are not recommended).
- ▶ Doors matching the style ordered will be installed on hood.
- ▶ Durham and Overton Toasted Antique doors will have a glazed appearance, but rest of wood hood unit will be painted Antique.
- ▶ Wood Hoods ordered in Rustic Birch will not feature Rustic characteristics.
- ▶ Exhaust system not included. Compatible with TWHBLOWER390, TWHBLOWER500, and TWHCONVKIT.
- ▶ Check your local building code for installation heights above the range.
- ▶ Silver metallic liner included. Liner opening size: 10³/₄" deep by 19¹/₂" wide. Assembly required.
- ▶ Installation instructions and hardware included.

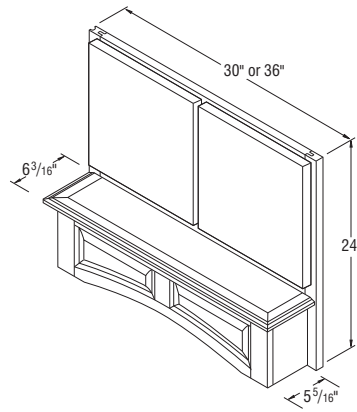

WHCA30
WHCA36

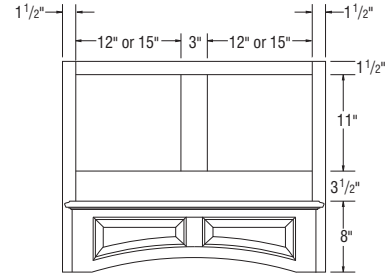

NOTES ✓

- ▶ Silver metallic liner included. Liner opening size: 10³/₄" deep by 19¹/₂" wide. Assembly required.
- ▶ Install Wood Hoods between adjoining 12" deep cabinets (15" deep cabinets are not recommended).
- ▶ When Antique is used for Durham and Overton, wood hood unit will not feature a glazed appearance. Toasted Antique not available.
- ▶ For Birch and Rustic Birch styles, order Maple. For Thermofoil and PureStyle™, order Maple paint.
- ▶ Check your local building code for installation heights above the range.
- ▶ TWH36 has two plain/fluted stiles with metal wings included to extend Hood to 36" width.
- ▶ Exhaust system not included. Compatible with TWHBLOWER390, TWHBLOWER500, and TWHCONVKIT.
- ▶ Wood Hoods are designed to be used with Acanthus Overlay (ACOVLY).

Tapered Wood Hoods, 30" and 36" Wide, 24" High

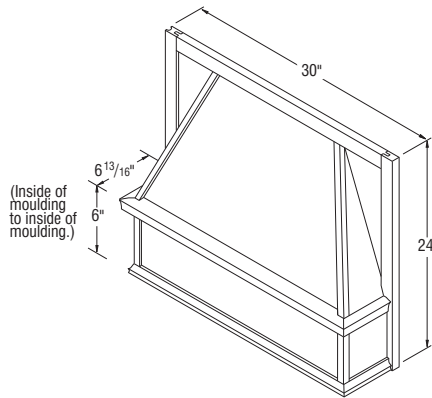

TWH30

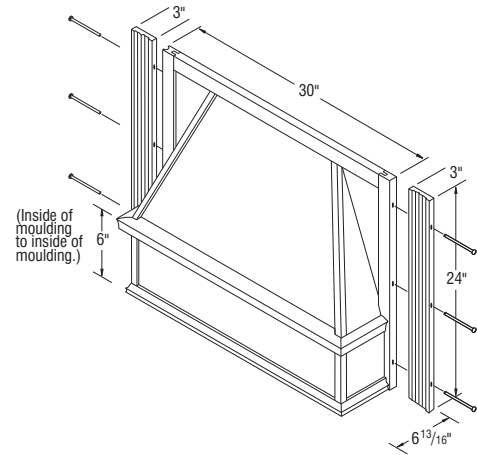

TWH36

Wood Hood Contemporary Straight, 30" and 36" Wide

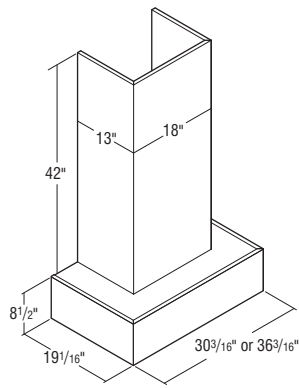

WHCONSTR30
WHCONSTR36

NOTES ✓

- ▶ Freestanding unit (must be properly secured to wall and cannot be attached to adjacent cabinets).
- ▶ Chimney included and can be trimmed. If trimmed, molding is recommended to cover any cut marks.
- ▶ Check your local building code for installation heights above the range.
- ▶ Silver metallic liner included. Assembly required.
- ▶ Installation instructions and hardware included.
- ▶ Liner opening size: 10 1/4" deep by 19 1/2" wide.
- ▶ Exhaust system not included. Compatible with TWHBLOWER390, TWHBLOWER500, and TWHCONVKIT.
- ▶ Not available in Glaze finishes.
- ▶ When Antique is used for Durham and Overton, wood hood unit will not feature a glazed appearance. Toasted Antique is not available.
- ▶ For Birch and Rustic Birch styles, order Maple. For Thermofoil and PureStyle™, order Maple paint.

Wood Hood Chimney, 30" and 36" Wide

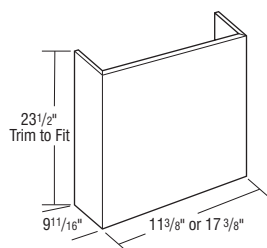

WHC30
WHCT30 *New*

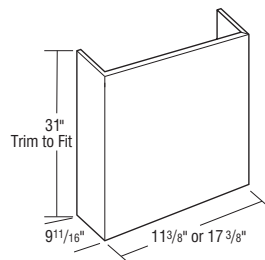

WHC36
WHCT36 *New*

NOTES ✓

- ▶ 3/4" thick plywood.
- ▶ Trimmable.
- ▶ Purchased with corresponding WHS.
- ▶ When Antique is used for Durham and Overton, wood hood unit will not feature a glazed appearance. Toasted Antique is not available.
- ▶ For Birch and Rustic Birch styles, order Maple. For Thermofoil and PureStyle™, order Maple paint.

NOTES ✓

- ▶ Freestanding unit (must be properly secured to wall and cannot be attached to adjacent cabinets).
- ▶ Chimney available (WHC..).
- ▶ Check your local building code for installation heights above the range.
- ▶ Powder coated silver metallic metal liner included.
- ▶ Installaton instructions and hardware included.
- ▶ Exhaust system not included. Compatible with TWHBLOWER390, TWHBLOWER500, and TWHCONVKIT.
- ▶ When Antique is used for Durham and Overton, wood hood unit will not feature a glazed appearance. Toasted Antique is not available.
- ▶ For Birch and Rustic Birch styles, order Maple. For Thermofoil and PureStyle™, order Maple paint.

Wood Hood Square, 30" and 36" Wide

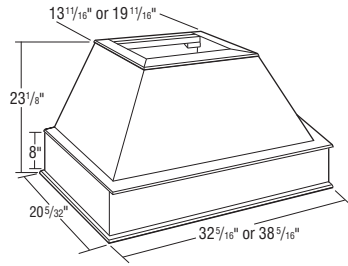

WHS30
WHS36

NOTES ✓

- ▶ Compatible with WHCA and TWH Wood Hoods.
- ▶ 6" diameter vent.
- ▶ Silver metallic finish.
- ▶ One year warranty.
- ▶ Two 40-watt candelabra lights, (not included), and three fan setting levels.
- ▶ CFM Rating - TWHBLOWER390 - 390 CFM (cubic feet per minute) TWHBLOWER500 - 500 CFM (cubic feet per minute)
- ▶ Order under style #010. Manufacturer recommends 24"-30" clearance between cooking surface and blower unit.
- ▶ Includes a dishwasher-safe aluminum filter for use with external ducting. Does not include charcoal filter for internal ducting with conversion kit (see FILTER390).

Wood Hood Blower

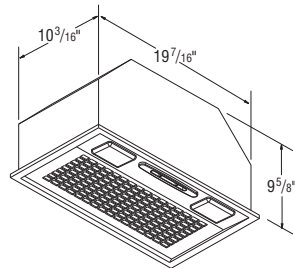

TWHBLOWER390

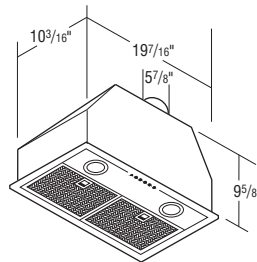

TWHBLOWER500



Wood Hood Conversion Kit

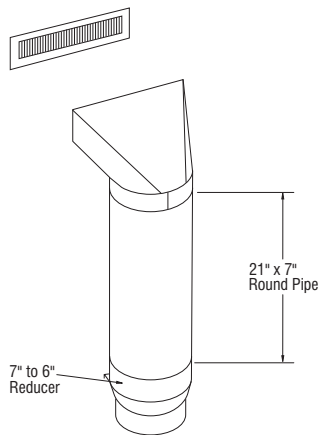

TWHCONVKIT

NOTES ✓

- ▶ Kit allows TWHBLOWER390 and TWHBLOWER500 to be vented internally.
- ▶ Order under style #010.
- ▶ Kit includes: One 21" x 7" round pipe, 1 adjustable collar, 1 white metal soffit grille, 1 adjustable boot, a 7" to 6" reducer, and FILTER390 (for TWHBLOWER390) or FILTER500 (for TWHBLOWER500).
- ▶ FILTER390 and FILTER500 also available to order separately for replacements.



Filters

FILTER390
FILTER500

NOTES ✓

- ▶ Replacement charcoal filter for use when wood hood blower is ducted internally with the wood hood conversion kit (TWHCONVKIT).
- ▶ FILTER390 for use with TWHBLOWER390.
- ▶ FILTER500 for use with TWHBLOWER500.



Diagonal Corner Wall Cabinets, 30" High, 12" & 15" Deep

NOTES ✓

- ▶ Two adjustable shelves.
- ▶ Cabinets use standard natural maple interior, excluding white which has a white interior.
- ▶ All Diagonal Wall cabinets are reversible except for Arch styles.
- ▶ When installing, DC cabinets must be attached to at least one run of cabinets and both back walls.
- ▶ All full overlay doors are smaller to allow for proper door opening.

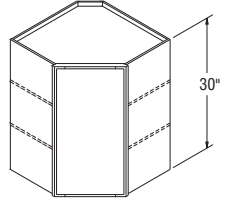

DC2430*
DC2730*

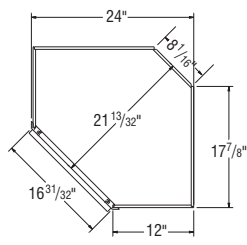

DC2430
TOP VIEW

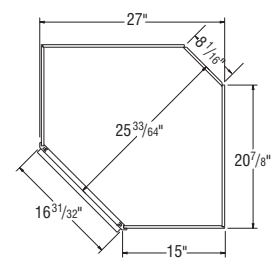

DC2730
TOP VIEW

DESIGN SOLUTIONS

- ▶ Apply an End Panel Skin to create a flush end on the side of a Wall cabinet if installed at the end of a run for ease of Moulding installation.

*Specify L or R on Arch styles.

Diagonal Corner Wall Cabinets, 36" High, 12" & 15" Deep

NOTES ✓

- ▶ Two adjustable shelves.
- ▶ Cabinets use standard natural maple interior, excluding white which has a white interior.
- ▶ All Diagonal Wall cabinets are reversible except for Arch styles.
- ▶ When installing, DC cabinets must be attached to at least one run of cabinets and both back walls.
- ▶ All full overlay doors are smaller to allow for proper door opening.

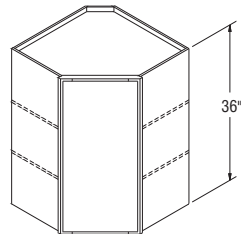

DC2436*
DC2736*

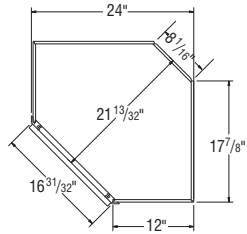

DC2436
TOP VIEW

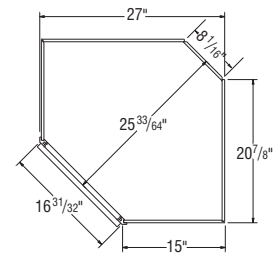

DC2736
TOP VIEW

DESIGN SOLUTIONS

- ▶ Apply an End Panel Skin to create a flush end on the side of a Wall cabinet if installed at the end of a run for ease of Moulding installation.

*Specify L or R on Arch styles.

Diagonal Corner Wall Cabinets, 42" High, 12" & 15" Deep

NOTES ✓

- ▶ Three adjustable shelves.
- ▶ Cabinets use standard natural maple interior, excluding white which has a white interior.
- ▶ All Diagonal Wall cabinets are reversible except for Arch styles.
- ▶ When installing, DC cabinets must be attached to at least one run of cabinets and both back walls.
- ▶ All full overlay doors are smaller to allow for proper door opening.
- ▶ When varying heights, make sure to also vary depths to allow moulding to lie against adjacent side of cabinet.

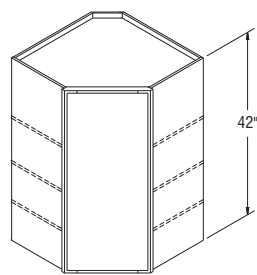

DC2442*
DC2742*

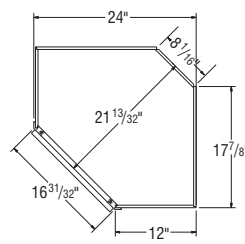

DC2442
TOP VIEW

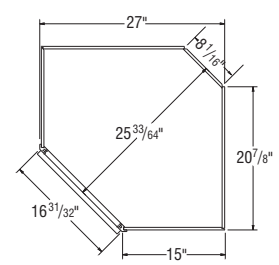

DC2742
TOP VIEW

DESIGN SOLUTIONS

- ▶ Apply an End Panel Skin to create a flush end on the side of a Wall cabinet if installed at the end of a run for ease of Moulding installation.

*Specify L or R on Arch styles.

Diagonal Corner Open Wall Cabinets, 30" High, 12" & 15" Deep

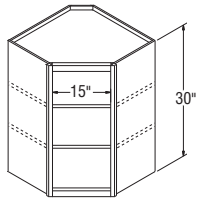

DCOL2430
DCOL2730

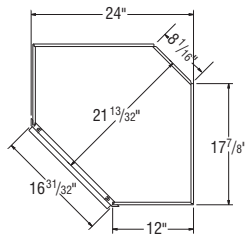

DCOL2430
TOP VIEW

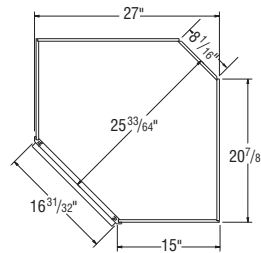

DCOL2730
TOP VIEW

NOTES ✓

- ▶ Two adjustable 3/4" thick matching Aristex® shelves.
- ▶ Cabinets include matching Aristex® interior.
- ▶ If a door is desired for a 7/16" partial overlay style, use a W1830 size door.
- ▶ Full overlay door styles cannot be added.
- ▶ When installing, DCOL cabinets must be attached to at least one run of cabinets and both back walls.

DESIGN SOLUTIONS

- ▶ Apply an End Panel Skin to create a flush end on the side of a Wall cabinet if installed at the end of a run for ease of Moulding installation.

Diagonal Corner Open Wall Cabinets, 36" High, 12" & 15" Deep

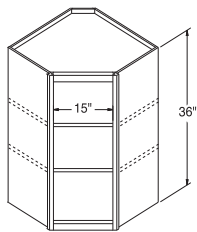

DCOL2436
DCOL2736

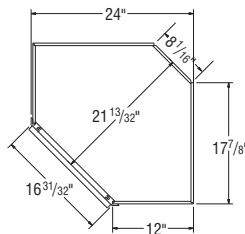

DCOL2436
TOP VIEW

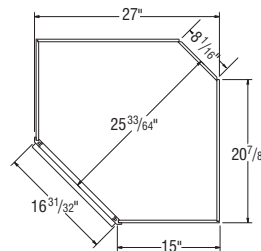

DCOL2736
TOP VIEW

NOTES ✓

- ▶ Two adjustable 3/4" thick matching Aristex® shelves.
- ▶ Cabinets include matching Aristex® interior.
- ▶ If a door is desired for a 7/16" partial overlay style, use a W1836 size door.
- ▶ Full overlay door styles cannot be added.
- ▶ When installing, DCOL cabinets must be attached to at least one run of cabinets and both back walls.

DESIGN SOLUTIONS

- ▶ Apply an End Panel Skin to create a flush end on the side of a Wall cabinet if installed at the end of a run for ease of Moulding installation.

Diagonal Corner Open Wall Cabinets, 42" High, 12" & 15" Deep

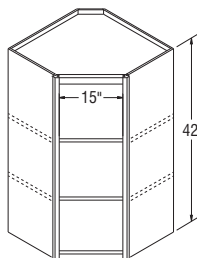

DCOL2442
DCOL2742

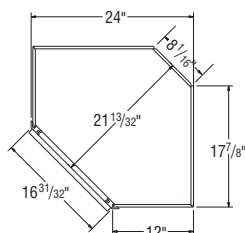

DCOL2442 TOP VIEW

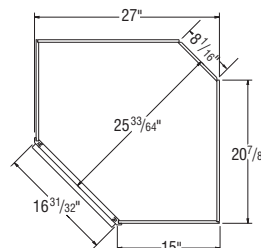

DCOL2742 TOP VIEW

NOTES ✓

- ▶ Two adjustable 3/4" thick matching Aristex® shelves.
- ▶ Cabinets include matching Aristex® interior.
- ▶ If a door is desired for a 7/16" partial overlay style, use a W1842 size door.
- ▶ Full overlay door styles cannot be added.
- ▶ When installing, DCOL cabinets must be attached to at least one run of cabinets and both back walls.

DESIGN SOLUTIONS

- ▶ Apply an End Panel Skin to create a flush end on the side of a Wall cabinet if installed at the end of a run for ease of Moulding installation.

NOTES ✓

- ▶ Two adjustable 3/4" thick matching Aristex® shelves align with door mullions on Standard mullions, but do not align on Shaker mullions.
- ▶ Cabinets include installed, clear tempered glass, and matching Aristex® interior.
- ▶ All Diagonal Wall cabinets are reversible except for Arch styles.
- ▶ When installing, DCMD cabinets must be attached to at least one run of cabinets and both back walls.
- ▶ All full overlay doors are smaller to allow for proper door opening.
- ▶ See page 29 for Standard and Shaker mullion door style availability and grid configurations.
- ▶ Mullion Door cabinets are not available in Teagan or VanWyke.

DESIGN SOLUTIONS

- ▶ Apply an End Panel Skin to create a flush end on the side of a Wall cabinet if installed at the end of a run for ease of Moulding installation.
- ▶ For complementary Wall Mullion Door cabinets in Teagan, order as Winstead Maple, as Brellin, Teagan features a slab door design.

Diagonal Corner Wall Cabinets with Mullion Door, 30" High, 12" & 15" Deep

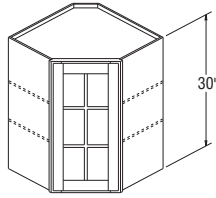

DCMD2430*
DCMD2730*

*Specify L or R on Arch styles.

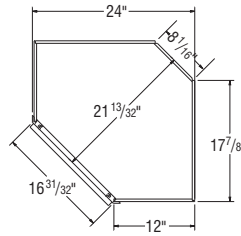

DCMD2430
TOP VIEW

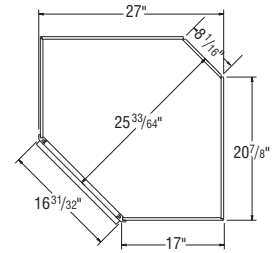

DCMD2730
TOP VIEW

NOTES ✓

- ▶ Two adjustable 3/4" thick matching Aristex® shelves align with door mullions on Standard mullions, but do not align on Shaker mullions.
- ▶ Cabinets include installed, clear tempered glass, and matching Aristex® interior.
- ▶ All Diagonal Wall cabinets are reversible except for Arch styles.
- ▶ When installing, DCMD cabinets must be attached to at least one run of cabinets and both back walls.
- ▶ All full overlay doors are smaller to allow for proper door opening.
- ▶ See page 29 for Standard and Shaker mullion door style availability and grid configurations.
- ▶ Mullion Door cabinets are not available in Brellin, Teagan or VanWyke.

DESIGN SOLUTIONS

- ▶ Apply an End Panel Skin to create a flush end on the side of a Wall cabinet if installed at the end of a run for ease of Moulding installation.
- ▶ For complementary Wall Mullion Door cabinets in Teagan, order as Winstead Maple, as Teagan features a slab door design.

Diagonal Corner Wall Cabinets with Mullion Door, 36" High, 12" & 15" Deep

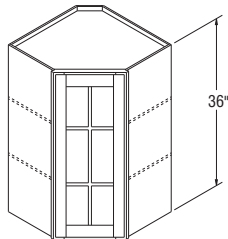

DCMD2436*
DCMD2736*

*Specify L or R on Arch styles.

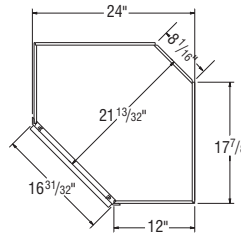

DCMD2436
TOP VIEW

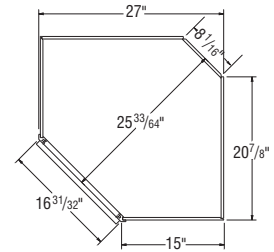

DCMD2736
TOP VIEW

Diagonal Corner Wall Cabinets with Mullion Door, 42" High, 12" & 15" Deep

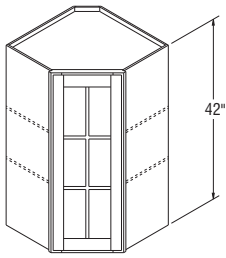

DCMD2442*
DCMD2742*

*Specify L or R on Arch styles.

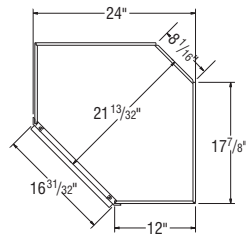

DCMD2442
TOP VIEW

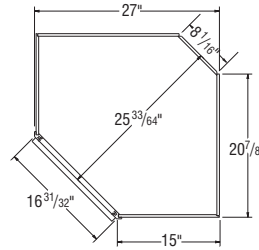

DCMD2742
TOP VIEW

NOTES

- ▶ Two adjustable 3/4" thick matching Aristex® shelves align with door mullions on Standard mullions, but do not align on Shaker mullions.
- ▶ Cabinets include installed, clear tempered glass, and matching Aristex® interior.
- ▶ All Diagonal Wall cabinets are reversible except for Arch styles.
- ▶ When installing, DCMD cabinets must be attached to at least one run of cabinets and both back walls.
- ▶ All full overlay doors are smaller to allow for proper door opening.
- ▶ See page 29 for Standard and Shaker mullion door style availability and grid configurations.
- ▶ Mullion Door cabinets are not available in Brellin, Teagan or VanWyke.

DESIGN SOLUTIONS

- ▶ Apply an End Panel Skin to create a flush end on the side of a Wall cabinet if installed at the end of a run for ease of Moulding installation.
- ▶ For complementary Wall Mullion Door cabinets in Teagan, order as Winstead Maple, as Teagan features a slab door design.

Diagonal Corner Wall Cabinets w/Door Prepped for Glass, 30" High, 12" & 15" Deep

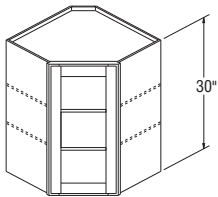

DCPG2430*
DCPG2730*

*Specify L or R on Arch styles.

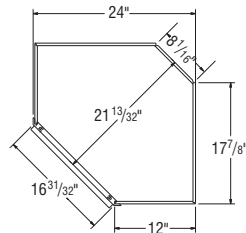

DCPG2430
TOP VIEW

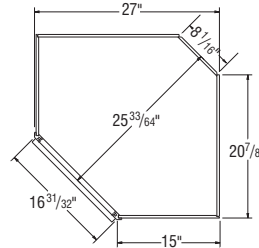

DCPG2730
TOP VIEW

NOTES

- ▶ Cabinets include matching Aristex® interior, two adjustable 3/4" thick matching Aristex® shelves, and clips to install glass (glass not included).
- ▶ All Diagonal Wall cabinets are reversible except for Arch styles.
- ▶ When installing, DCPG cabinets must be attached to at least one run of cabinets and both back walls.
- ▶ All full overlay doors are smaller to allow for proper door opening.
- ▶ Wall Prepped for Glass cabinets are not available in Augusta, Nantucket, Teagan, or VanWyke.

DESIGN SOLUTIONS

- ▶ Apply an End Panel Skin to create a flush end on the side of a Wall cabinet if installed at the end of a run for ease of Moulding installation.
- ▶ For complementary Wall Mullion Door cabinets in Teagan, order as Winstead Maple, as Teagan features a slab door design.

NOTES ✓

- ▶ Cabinets include matching Aristex® interior, two adjustable 3/4" thick matching Aristex® shelves, and clips to install glass (glass not included).
- ▶ All Diagonal Wall cabinets are reversible except for Arch styles.
- ▶ When installing, DCPG cabinets must be attached to at least one run of cabinets and both back walls.
- ▶ All full overlay doors are smaller to allow for proper door opening.
- ▶ Wall Prepped for Glass cabinets are not available in Augusta, Nantucket, Teagan, or VanWyke.

DESIGN SOLUTIONS

- ▶ Apply an End Panel Skin to create a flush end on the side of a Wall cabinet if installed at the end of a run for ease of Moulding installation.
- ▶ For complementary Wall Mullion Door cabinets in Teagan, order as Winstead Maple, as Teagan features a slab door design.

Diagonal Corner Wall Cabinets w/Door Prepped for Glass, 36" High, 12" & 15" Deep

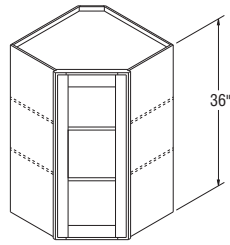

DCPG2436*
DCPG2736*

*Specify L or R on Arch styles.

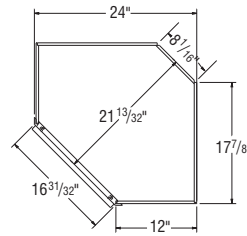

DCPG2436
TOP VIEW

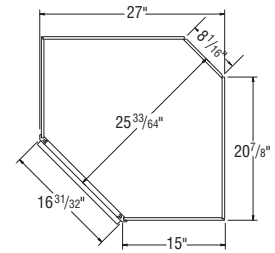

DCPG2736
TOP VIEW

NOTES ✓

- ▶ Cabinets include matching Aristex® interior, two adjustable 3/4" thick matching Aristex® shelves, and clips to install glass (glass not included).
- ▶ All Diagonal Wall cabinets are reversible except for Arch styles.
- ▶ When installing, DCPG cabinets must be attached to at least one run of cabinets and both back walls.
- ▶ All full overlay doors are smaller to allow for proper door opening.
- ▶ Wall Prepped for Glass cabinets are not available in Augusta, Nantucket, Teagan, or VanWyke.

DESIGN SOLUTIONS

- ▶ Apply an End Panel Skin to create a flush end on the side of a Wall cabinet if installed at the end of a run for ease of Moulding installation.
- ▶ For complementary Wall Mullion Door cabinets in Teagan, order as Winstead Maple, as Teagan features a slab door design.

Diagonal Corner Wall Cabinets w/Door Prepped for Glass, 42" High, 12" & 15" Deep

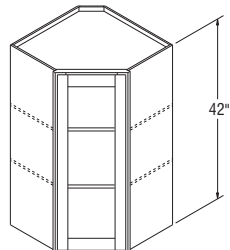

DCPG2442*
DCPG2742*

*Specify L or R on Arch styles.

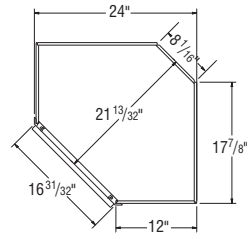

DCPG2442
TOP VIEW

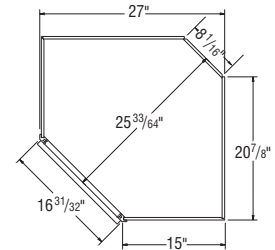

DCPG2742
TOP VIEW

Diagonal Corner Roto Wall Cabinet, 30" High, 12" Deep

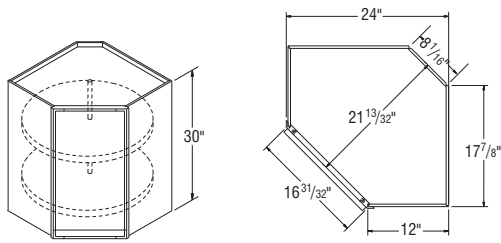

DCR2430*

TOP VIEW

*Specify L or R on Arch styles.

NOTES ✓

- ▶ Includes two white Roto shelves. Each shelf holds 30 lbs.
- ▶ 18" diameter shelves.
- ▶ Cabinets use standard natural maple interior, excluding white which has a white interior.
- ▶ Doors are reversible except for Arch styles.
- ▶ Cabinets must be attached to at least one run of cabinets and both back walls.

DESIGN SOLUTIONS

- ▶ Apply an End Panel Skin to create a flush end on the side of a Wall cabinet if installed at the end of a run for ease of Moulding installation.



Wall Easy Reach Cabinet, 30", 36", or 42" High, 12" Deep

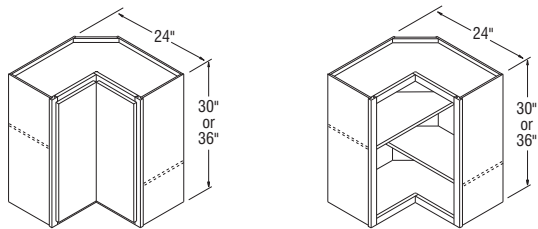

WER2430*
WER2436*

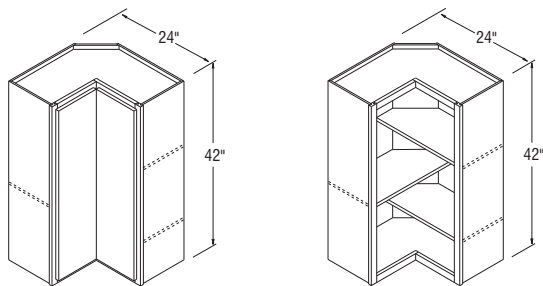

WER2442*

*Specify L or R on Arch styles.

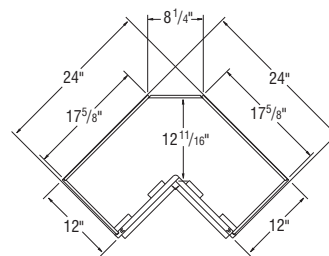

TOP VIEW

NOTES ✓

- ▶ WER2430 and WER2436 include two adjustable shelves.
- ▶ WER2442 includes three adjustable shelves.
- ▶ Cabinets use standard natural maple interior, excluding white which has a white interior.
- ▶ Doors are reversible except for Arch styles.
- ▶ One knuckle hinge door.
- ▶ Includes magnetic catch.
- ▶ Cabinets must be attached to at least one run of cabinets and both back walls.
- ▶ Soft Close Hinges are not available in Select and APC Construction.

DESIGN SOLUTIONS

- ▶ Apply an End Panel Skin to create a flush end on the side of a Wall cabinet if installed at the end of a run for ease of Moulding installation.



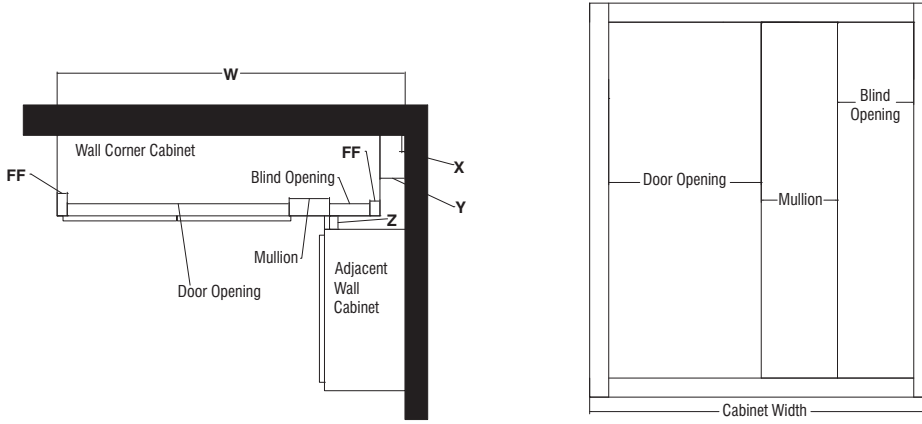

Full Overlay Square Corner Wall Cabinet Information

Full Overlay Styles	Actual Cabinet Width	X		Y	Z		W	
		Min. Pull	Min. Pull w/Hardware	Max. Pull	Min. Filler Required	Min. Filler Required w/Hardware	Min. Pull From Wall To End of Cabinet	Max Pull From Wall To End of Cabinet
SC24__	24"	1"	2½"	¾"	1"	2½"	25"	27¾"
SC30__	30"	1"	2½"	¾"	1"	2½"	31"	33¾"
SC33__	33"	1"	2½"	¾"	1"	2½"	34"	36¾"
SC36__	36"	1"	2½"	¾"	1"	2½"	39"	39¾"
SC42__	42"	1"	2½"	¾"	1"	2½"	43"	45¾"
SC48__	48"	1"	2½"	¾"	1"	2½"	49"	51¾"

7/16" Overlay Square Corner Wall Cabinet Information

7/16" Overlay Styles	Actual Cabinet Width	X		Y	Z		W	
		Min. Pull	Min. Pull w/Hardware	Max. Pull	Min. Filler Required	Min. Filler Required w/Hardware	Min. Pull From Wall To End of Cabinet	Max Pull From Wall To End of Cabinet
SC24__	24"	½"	2"	¾"	½"	2"	24½"	27¾"
SC30__	30"	½"	2"	¾"	½"	2"	30½"	33¾"
SC33__	33"	½"	2"	¾"	½"	2"	33½"	36¾"
SC36__	36"	½"	2"	¾"	½"	2"	36½"	39¾"
SC42__	42"	½"	2"	¾"	½"	2"	42½"	45¾"
SC48__	48"	½"	2"	¾"	½"	2"	48½"	51¾"

Square Corner Wall Door and Opening Sizes

SKU	7/16" Overlay Door	Full Overlay Door	Door Opening
SC2430	9⅞" x 27⅞"	11½" x 29½"	9" x 27"
SC3030	15⅞" x 27⅞"	17½" x 29½"	15" x 27"
SC3330	18⅞" x 27⅞"	20½" x 29½"	18" x 27"
SC3630	21⅞" x 27⅞"	23½" x 29½"	21" x 27"
SC4230B	13⅞" x 27⅞"	14⅞" x 29½"	12" x 27"
SC4830B	16⅞" x 27⅞"	17⅞" x 29½"	15" x 27"
SC2436	9⅞" x 33⅞"	11½" x 35½"	9" x 33"
SC3036	15⅞" x 33⅞"	17½" x 35½"	9" x 33"
SC3336	18⅞" x 33⅞"	20½" x 35½"	15" x 33"
SC3636	21⅞" x 33⅞"	23½" x 35½"	18" x 33"
SC4236B	13⅞" x 33⅞"	14⅞" x 35½"	12" x 33"
SC4836B	16⅞" x 33⅞"	17⅞" x 35½"	15" x 33"
SC2442	9⅞" x 39⅞"	11½" x 41½"	9" x 39"
SC3042	15⅞" x 39⅞"	17½" x 41½"	15" x 39"
SC3342	18⅞" x 39⅞"	20½" x 41½"	18" x 39"
SC3642	21⅞" x 39⅞"	23½" x 41½"	21" x 39"
SC4242B	13⅞" x 39⅞"	14⅞" x 41½"	12" x 39"
SC4842B	16⅞" x 39⅞"	17⅞" x 41½"	15" x 39"

Square Corner Wall Cabinets, 30" High, 12" Deep

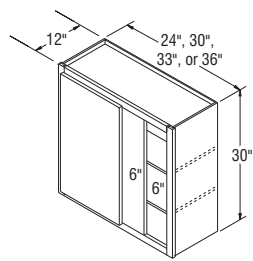

SC2430*
SC3030*
SC3330*
SC3630*

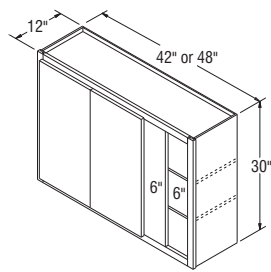

SC4230B*
SC4830B*

*Specify L or R blind designation on all Arch styles.

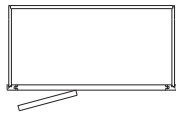

TOP VIEW
SC (RIGHT)

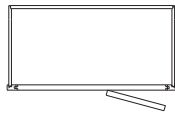

TOP VIEW
SC (LEFT)

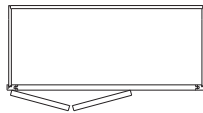

TOP VIEW
SC (RIGHT)

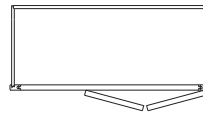

TOP VIEW
SC (LEFT)

NOTES ✓

- ▶ Two adjustable shelves.
- ▶ Cabinets use standard natural maple interior, excluding white which has a white interior.
- ▶ 3" Filler is included. Filler Overlays shipped unattached with Brellin, Briarcliff II, Dryden, Durham, Eastland, Nantucket, Overton, and Wentworth styles.
- ▶ Hinging determines location of the blind. Door attaches to blind panel.
- ▶ Cabinets are reversible, except for Arch styles.
- ▶ Cover panel shipped with cabinet for field installation to cover 6" blind opening.
- ▶ Reference Installation Charts for proper sizing identification, see page 76.

DESIGN SOLUTIONS

- ▶ When a cabinet is "pulled," it will use proportionally more wall space. For example, a 30" wide Wall cabinet pulled 2" will use 32" of space.
- ▶ Blind side of Wall Corner cabinets cannot be installed next to a Range Hood or Microwave Shelf due to door interference.

Square Corner Wall Cabinets, 36" High, 12" Deep

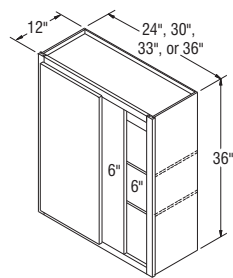

SC2436*
SC3036*
SC3336*
SC3636*

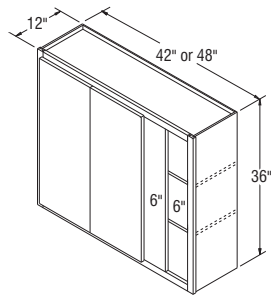

SC4236B*
SC4836B*

*Specify L or R blind designation on all Arch styles.

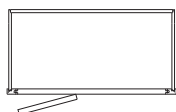

TOP VIEW
SC (RIGHT)

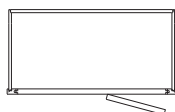

TOP VIEW
SC (LEFT)

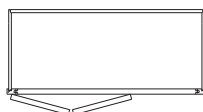

TOP VIEW
SC (RIGHT)

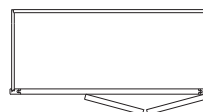

TOP VIEW
SC (LEFT)

NOTES ✓

- ▶ Two adjustable shelves.
- ▶ Cabinets use standard natural maple interior, excluding white which has a white interior.
- ▶ 3" Filler is included. Filler Overlays shipped unattached with Brellin, Briarcliff II, Dryden, Durham, Eastland, Nantucket, Overton, and Wentworth styles.
- ▶ Hinging determines location of the blind. Door attaches to blind panel.
- ▶ Cabinets are reversible, except for Arch styles.
- ▶ Cover panel shipped with cabinet for field installation to cover 6" blind opening.
- ▶ Reference Installation Charts for proper sizing identification, see page 76.

DESIGN SOLUTIONS

- ▶ When a cabinet is "pulled," it will use proportionally more wall space. For example, a 30" wide Wall cabinet pulled 2" will use 32" of space.
- ▶ Blind side of Wall Corner cabinets cannot be installed next to a Range Hood or Microwave Shelf due to door interference.

NOTES ✓

- ▶ Three adjustable shelves.
- ▶ Cabinets use standard natural maple interior, excluding white which has a white interior.
- ▶ 3" Filler is included. Filler Overlays shipped unattached with Brellin, Briarcliff II, Dryden, Durham, Eastland, Nantucket, Overton, and Wentworth styles.
- ▶ Hinging determines location of the blind. Door attaches to blind panel.
- ▶ Cabinets are reversible, except for Arch styles.
- ▶ Cover panel shipped with cabinet for field installation to cover 6" blind opening.
- ▶ Reference Installation Charts for proper sizing identification, see page 76.

DESIGN SOLUTIONS

- ▶ When a cabinet is "pulled," it will use proportionally more wall space. For example, a 30" wide Wall cabinet pulled 2" will use 32" of space.
- ▶ Blind side of Wall Corner cabinets cannot be installed next to a Range Hood or Microwave Shelf due to door interference.

Square Corner Wall Cabinets, 42" High, 12" Deep

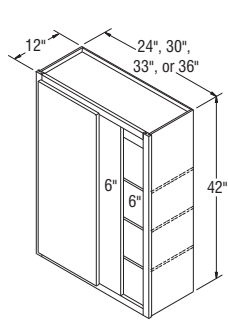

SC2442*
SC3042*
SC3342*
SC3642*

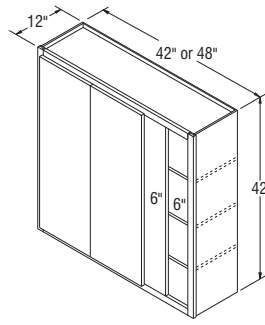

SC4242B*
SC4842B*

*Specify L or R blind designation on all Arch styles.

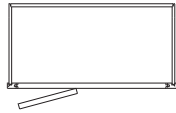

TOP VIEW
 SC (RIGHT)

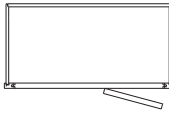

TOP VIEW
 SC (LEFT)

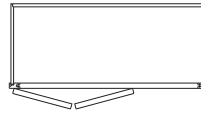

TOP VIEW
 SC (RIGHT)

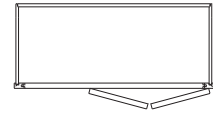

TOP VIEW
 SC (LEFT)

Wall End Cabinets, Single Door, 30", 36", and 42" High, 12" Deep

NOTES ✓

- ▶ WEC1242 includes three adjustable shelves; WEC1236 and WEC1230 include two adjustable shelves.
- ▶ Cabinets use standard natural maple interior, excluding white which has a white interior.
- ▶ Cabinet backs will not match front.

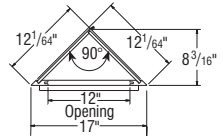
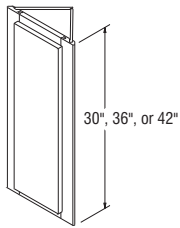

TOP VIEW

WEC1230*
WEC1236*
WEC1242*

*Specify L or R for all Arch styles.

Wall End Cabinets, Double Door, 30", 36", and 42" High, 12" Deep

NOTES ✓

- ▶ 42" high cabinets include three adjustable shelves; 36" and 30" cabinets include two adjustable shelves.
- ▶ Cabinets use standard natural maple interior, excluding white which has a white interior.

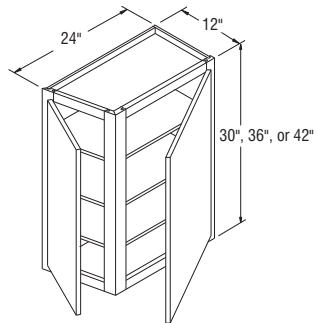

ANGLE - LEFT
HINGE - RIGHT

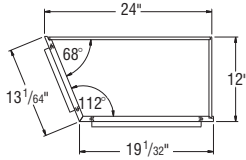

TOP VIEW

WECL2430* **WECR2436***
WECL2430* **WECL2442***
WECL2436* **WECL2442***

*Specify L or R to indicate hinging for front door on all styles.

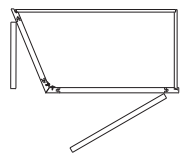

TOP VIEW
ANGLE - LEFT
HINGE - RIGHT

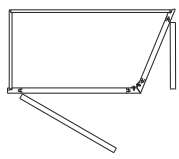

TOP VIEW
ANGLE - RIGHT
HINGE - LEFT

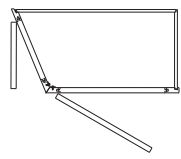

TOP VIEW
ANGLE - LEFT
HINGE - LEFT

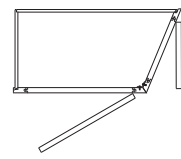

TOP VIEW
ANGLE - RIGHT
HINGE - RIGHT

Peninsula Wall Cabinets, 18" High, 12" Deep

NOTES ✓

- ▶ Shelves not available in cabinets less than 24" in height.
- ▶ Cabinets use standard natural maple interior, excluding white which has a white interior.

DESIGN SOLUTIONS

- ▶ Apply an End Panel Skin to create a flush end on the side of a Wall cabinet if installed at the end of a run for ease of Moulding installation.

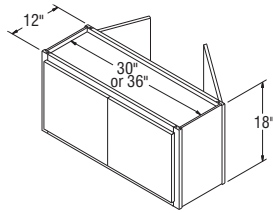

PW3018B
PW3618B

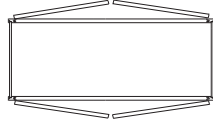

TOP VIEW

Peninsula Wall Cabinets, 24" High, 12" Deep

NOTES ✓

- ▶ One adjustable shelf.
- ▶ Cabinets use standard natural maple interior, excluding white which has a white interior.
- ▶ Single door reversible.

DESIGN SOLUTIONS

- ▶ Apply an End Panel Skin to create a flush end on the side of a Wall cabinet if installed at the end of a run for ease of Moulding installation.

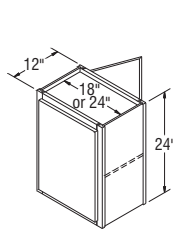

PW1824
PW2424

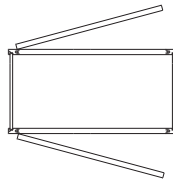

TOP VIEW

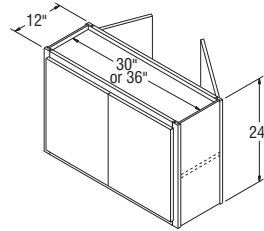

PW3024B
PW3624B

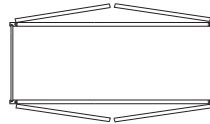

TOP VIEW

Peninsula Wall Cabinets, 30" High, 12" Deep

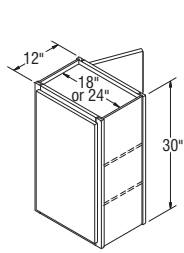

PW1830
PW2430

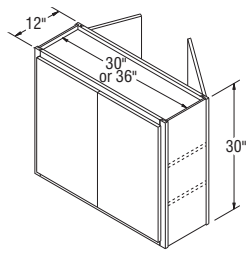

PW3030B
PW3630B

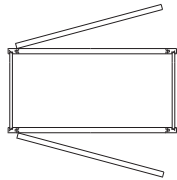

TOP VIEW

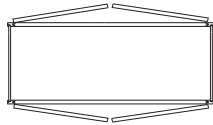

TOP VIEW

NOTES ✓

- ▶ Two adjustable shelves.
- ▶ Cabinets use standard natural maple interior, excluding white which has a white interior.
- ▶ Single door reversible.

DESIGN SOLUTIONS

- ▶ Apply an End Panel Skin to create a flush end on the side of a Wall cabinet if installed at the end of a run for ease of Moulding installation.

Peninsula Wall Cabinets with 4 Mullion Doors, 24" High, 12" Deep

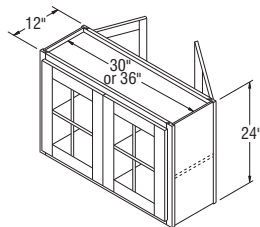

PWMD3024B
PWMD3624B

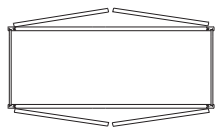

TOP VIEW

NOTES ✓

- ▶ One adjustable $\frac{3}{4}$ " thick matching Aristex® shelf aligns with door mullions on Standard mullions, but does not align on Shaker mullions.
- ▶ Cabinets include installed clear tempered glass and matching Aristex® interior.
- ▶ Matching Aristex® interior.
- ▶ All doors are mullion.
- ▶ Backs of face frames are unfinished. See page 29 for Standard and Shaker mullion door style availability and grid configurations.
- ▶ Peninsula Mullion Door cabinets are not available in Brellin, Teagan or VanWyke.

DESIGN SOLUTIONS

- ▶ Apply an End Panel Skin to create a flush end on the side of a Wall cabinet if installed at the end of a run for ease of Moulding installation.
- ▶ For complementary Peninsula Wall Mullion Door cabinets in Teagan, order as Winstead Maple, as Teagan features a slab door design.

NOTES ✓

- ▶ Cabinets include matching Aristex® interior, one adjustable ¾" thick shelf, and clips to install glass (glass not included).
- ▶ Peninsula Wall Prepped for Glass cabinets are not available in Augusta, Nantucket, Teagan, or VanWyke.

DESIGN SOLUTIONS

- ▶ Apply an End Panel Skin to create a flush end on the side of a Wall cabinet if installed at the end of a run for ease of Moulding installation.
- ▶ For complementary Peninsula Wall Prepped for Glass cabinets in Teagan, order as Winstead Maple, as Teagan features a slab door design.

Peninsula Wall Cabinets with 4 Doors Prepped for Glass, 24" High, 12" Deep

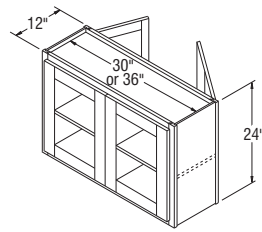

PWPG3024B
PWPG3624B

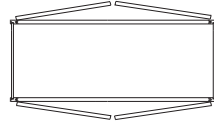

TOP VIEW

NOTES ✓

- ▶ Two adjustable shelves.
- ▶ Cabinets use standard natural maple interior, excluding white which has a white interior.
- ▶ When installing, the cabinet must be attached to at least one run of cabinets, the back wall, and the soffit for structural stability.
- ▶ All styles reversible except Arch.

DESIGN SOLUTIONS

- ▶ Apply an End Panel Skin to create a flush end on the side of a Wall cabinet if installed at the end of a run for ease of Moulding installation.

Peninsula Diagonal Corner Wall Cabinets, 30" High, 12" Deep

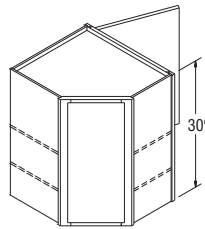

PDCL2430*
PDCR2430*

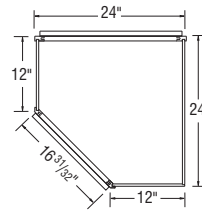

TOP VIEW

*Specify L or R to indicate hinging for front door on all styles.

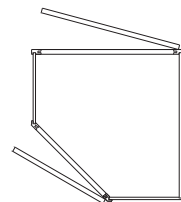

TOP VIEW
Peninsula Door - Left
Front Door Hinge - Right

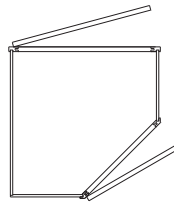

TOP VIEW
Peninsula Door - Right
Front Door Hinge - Left

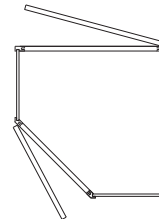

TOP VIEW
Peninsula Door - Left
Front Door Hinge - Left

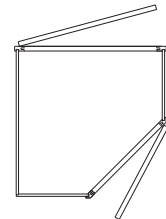

TOP VIEW
Peninsula Door - Right
Front Door Hinge - Right

Base Cabinets, 35" High, 23 3/4" Deep

NOTES ✓

- ▶ B09 is a Full Height door and does not include an adjustable shelf or vertical partition.
- ▶ Includes one fixed 1/2" thick half-depth shelf.

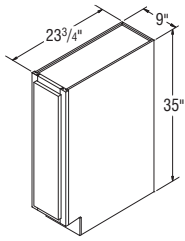

B09

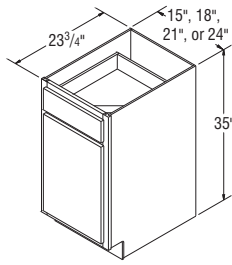

B12
B18
B18

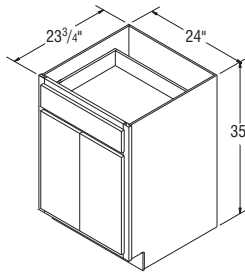

B24DD

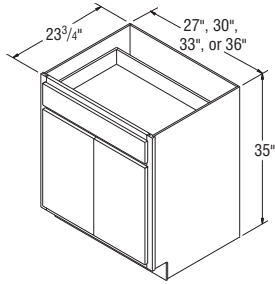

B27B
B30B
B33B
B36B

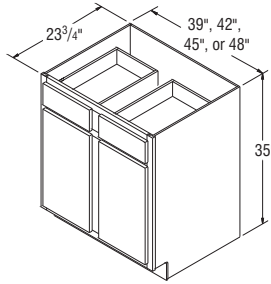

B39
B42
B45
B48

Base Cabinet Tray Divider, 35" High, 23 3/4" Deep *New*

NOTES ✓

- ▶ B09TD is a Full Height door and includes an installed chrome tray divider.
- ▶ B12TD includes a standard base drawer with two installed chrome tray dividers.
- ▶ Tray Divider is also available as an accessory for field installation. See page 167.
- ▶ Smart Stop™ drawer guides are not available on Roll Trays in Select and APC Construction.

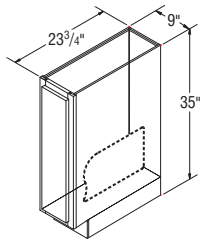

B09TD

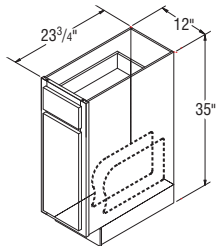

B12TD



NOTES ✓

- ▶ All Roll Tray cabinets include one half-depth fixed 1/2" thick shelf.
- ▶ Roll Trays feature 1/2" thick solid wood front and furniture board sides and back.
- ▶ Additional Roll Trays on page 166 may be ordered separately (TKIT).
- ▶ Upgrade charges do not include Roll Trays.
- ▶ Roll Tray Bumper Pads will be included for field installation.
- ▶ Smart Stop™ drawer guides are not available on Roll Trays in Select and APC Construction.



Base Cabinets with Roll Tray, 35" High, 23 3/4" Deep

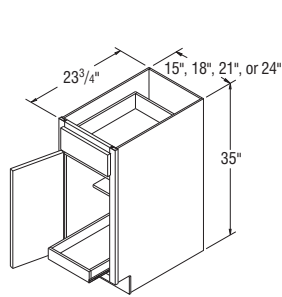

B15RT **B21RT**
B18RT **B24RT**

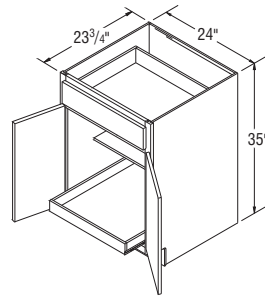

B24DDRT

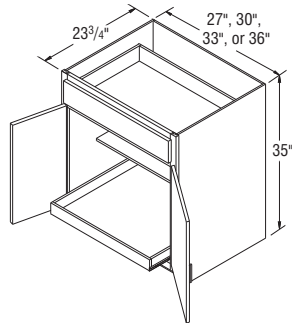

B27RTB
B30RTB
B33RTB
B36RTB

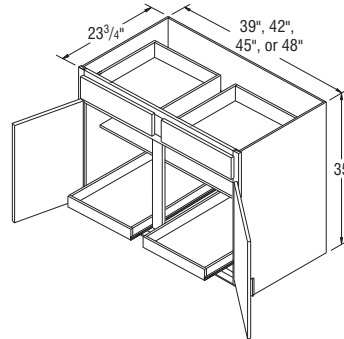

B39RT
B42RT
B45RT
B48RT

NOTES ✓

- ▶ Roll Trays feature 1/2" thick solid wood front and furniture board sides and back.
- ▶ Additional Roll Trays on page 166 may be ordered separately (TKIT).
- ▶ Upgrade charges do not include Roll Trays.
- ▶ Roll Tray Bumper Pads will be included for field installation.
- ▶ Smart Stop™ drawer guides are not available on Roll Trays in Select and APC Construction.



Base Cabinets with Double Roll Trays, 35" High, 23 3/4" Deep

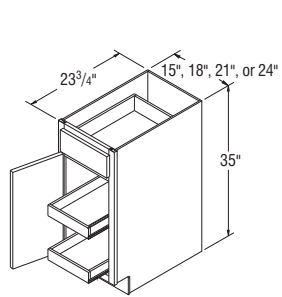

B15RT-2 **B21RT-2**
B18RT-2 **B24RT-2**

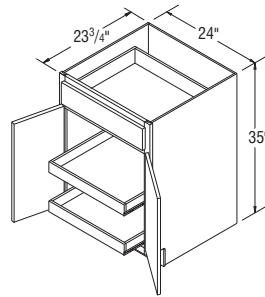

B24DDRT-2

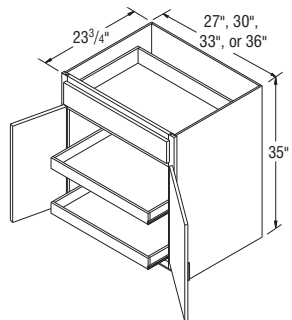

B27RT-2B
B30RT-2B
B33RT-2B
B36RT-2B

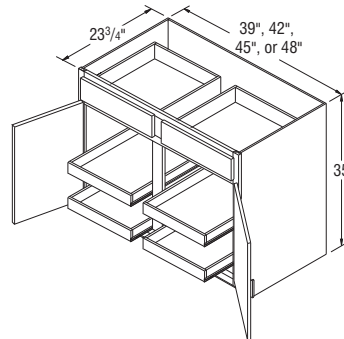

B39RT-2
B42RT-2
B45RT-2
B48RT-2

Base SuperCabinets™, 35" High, 30" Wide, 23 3/4" Deep (Pull-Out/Roll-Out)

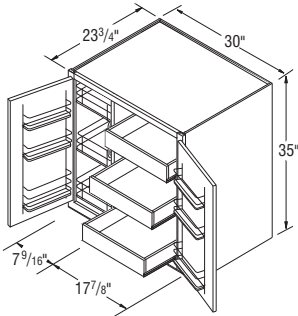

BSC30PRB

NOTES ✓

- ▶ SuperCabinet™ doors open 170° to allow sufficient Pull-Out clearance. When installing a SuperCabinet™ near a wall or corner, please allow 12" of adjacent space for proper operation of interior Pull-Outs.
- ▶ Roll Trays are solid wood dovetail boxes with Full Extension side-mounted guides.
- ▶ Upgrade charges do not include Roll Trays.
- ▶ Both doors will have a chrome and wood three-tiered rack that is 3 7/8" deep.
- ▶ Includes cabinet top.
- ▶ Soft Close Hinges are available in Select and APC Construction.
- ▶ Smart Stop™ drawer guides are not available on Roll Trays in Select and APC Construction.
- ▶ Roll Tray Bumper Pads must be ordered separately.



Base SuperCabinets™, 35" High, 30" Wide, 23 3/4" Deep (Roll-Out/Pull-Out)

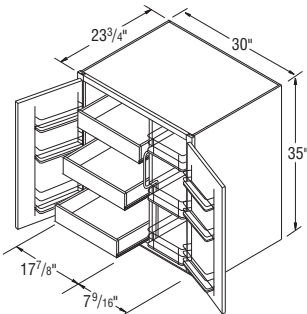

BSC30RPB

NOTES ✓

- ▶ SuperCabinet™ doors open 170° to allow sufficient Pull-Out clearance. When installing a SuperCabinet™ near a wall or corner, please allow 12" of adjacent space for proper operation of interior Pull-Outs.
- ▶ Roll Trays are solid wood dovetail boxes with Full Extension side-mounted guides.
- ▶ Upgrade charges do not include Roll Trays.
- ▶ Both doors will have a chrome and wood three-tiered rack that is 3 7/8" deep.
- ▶ Includes cabinet top.
- ▶ Soft Close Hinges are available in Select and APC Construction.
- ▶ Smart Stop™ drawer guides are not available on Roll Trays in Select and APC Construction.
- ▶ Roll Tray Bumper Pads must be ordered separately.



NOTES ✓

- ▶ SuperCabinet™ doors open 170° to allow sufficient Pull-Out clearance. When installing a SuperCabinet™ near a wall or corner, please allow 12" of adjacent space for proper operation of interior Pull-Outs.
- ▶ Roll Trays are solid wood dovetail boxes with Full Extension side-mounted guides.
- ▶ Upgrade charges do not include Roll Trays.
- ▶ Both doors will have a chrome and wood three-tiered rack that is 3 7/8" deep.
- ▶ Includes cabinet top.
- ▶ Soft Close Hinges are available in Select and APC Construction.
- ▶ Smart Stop™ drawer guides are not available on Roll Trays in Select and APC Construction.
- ▶ Roll Tray Bumper Pads must be ordered separately.



Base SuperCabinets™, 35" High, 36" Wide, 23 3/4" Deep (Pull-Out/Roll-Out/Pull-Out)

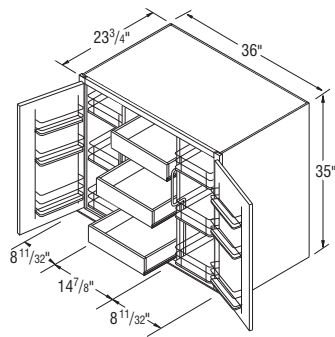

BSC36PRPB

Base Cabinets with Full Height Doors, 35" High, 12" Deep

NOTES ✓

- ▶ Includes one 3/4" full-depth adjustable shelf.
- ▶ Use with BEC12 (page 100) to transition from standard 23 3/4" depth to 12" depth.

DESIGN SOLUTIONS

- ▶ Use in designs to create varying depths in kitchens, islands, hutches, bookcases, offices, and bathrooms.

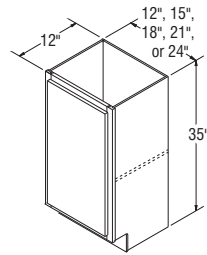

B12FH-12
B15FH-12
B18FH-12
B21FH-12
B24FH-12

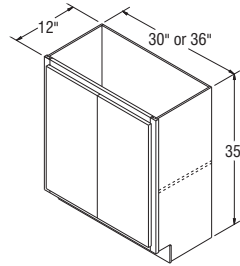

B30FH-12B
B36FH-12B

Base Cabinets with Full Height Doors, 35" High, 23 3/4" Deep

NOTES ✓

- ▶ Includes one 3/4" full-depth adjustable shelf.

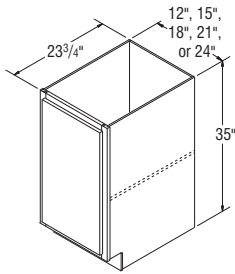

B12FH
B15FH
B18FH
B21FH
B24FH

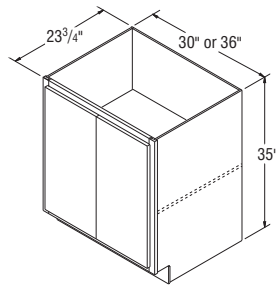

B30FHB
B36FHB

Base Box Column Pull-Out Cabinet, 30" High, 6" Wide, 23" Deep

NOTES ✓

- ▶ Features a wood Pull-Out unit with adjustable shelves, chrome rail sides, and Full Extension guides. Filler included, must be attached in the field.
- ▶ Recommend installation between two cabinets. Can be installed on the end of a run by using a 3/4" Refrigerator End Panel.
- ▶ It is recommended that the OL631 Overlay be applied to the front of the BBCP06 to give it a finished look.
- ▶ Smart Stop™ drawer guides are not available in Select and APC Construction.

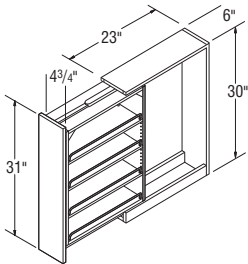

BBCP06*

*** In order to allow sufficient clearance, cabinet requires 6 1/8" space between adjacent cabinet face frames. Spacers included for proper installation.**

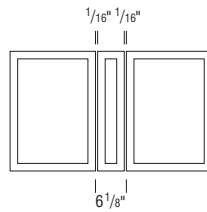

Total space required between face frames



Base Pantry Pull-Out Cabinet, 35" High, 9" Wide, 23 3/4" Deep

NOTES ✓

- ▶ Features a wood Pull-Out unit with adjustable shelves, chrome rail sides, and Full Extension guides.
- ▶ Nantucket and Grayson BPP09 cabinet doors utilize recessed center panels.
- ▶ Smart Stop™ drawer guides are not available in Select and APC Construction.

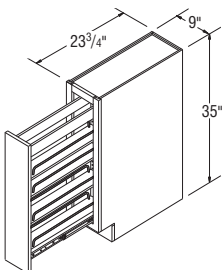

BPP09



NOTES ✓

- ▶ Cabinets include matching Aristex™ interior.
- ▶ Includes one 3/4" thick full-depth adjustable shelf.

Base Open Cabinets, 35" High, 12" Deep

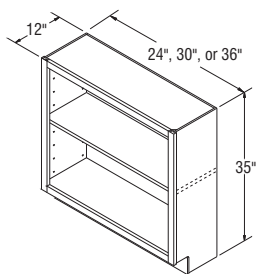

BOL2412
BOL3012
BOL3612

NOTES ✓

- ▶ Cabinets include matching Aristex™ interior.
- ▶ Includes one 3/4" thick full-depth adjustable shelf.

Base Open Cabinets, 35" High, 15" Deep

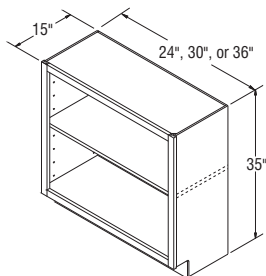

BOL2415
BOL3015
BOL3615

NOTES ✓

- ▶ Cabinets include installed clear tempered glass and matching Aristex™ interior.
- ▶ See page 29 for standard and shaker mullion door style availability and configurations.
- ▶ Mullion door cabinets not available in Brellin, Teagan, or VanWyke.
- ▶ Includes one 3/4" thick full depth adjustable shelf.

Base Cabinets with Mullion Doors, 35" High, 12" Deep

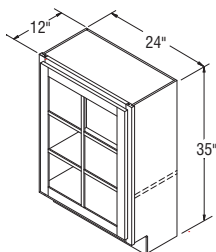

BMD2412FH

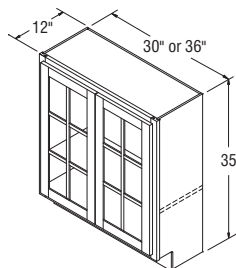

BMD3012FHB
BMD3612FHB

Base Cabinets with Mullion Doors, 35" High, 15" Deep

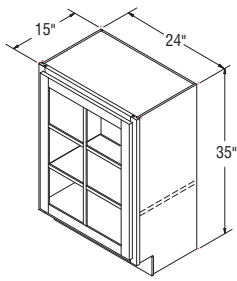

BMD2415FH

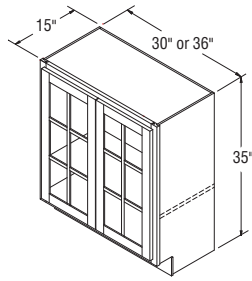

BMD3015FHB
BMD3615FHB

NOTES ✓

- ▶ Cabinets include installed clear tempered glass and matching Aristex™ interior.
- ▶ See page 29 for standard and shaker mullion door style availability and configurations.
- ▶ Mullion door cabinets not available in Brellin, Teagan, or VanWyke.
- ▶ Includes one ¾" thick full depth adjustable shelf.

Base Cabinets with Doors Prepped for Glass, 35" High, 12" Deep

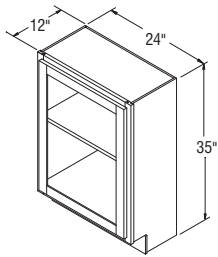

BPG2412FH

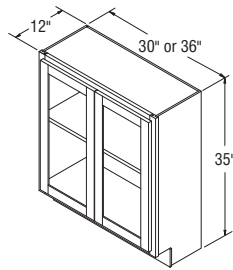

BPG3012FHB
BPG3612FHB

NOTES ✓

- ▶ Cabinets include matching Aristex™ interior and clips to install glass (glass not included).
- ▶ Includes one ¾" thick full depth adjustable shelf.
- ▶ Base Prepped for Glass Cabinets are not available in Augusta, Nantucket, Teagan, or VanWyke.

Base Cabinets with Doors Prepped for Glass, 35" High, 15" Deep

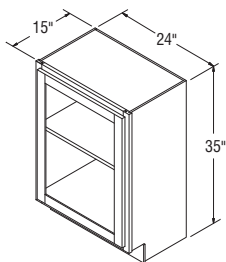

BPG2415FH

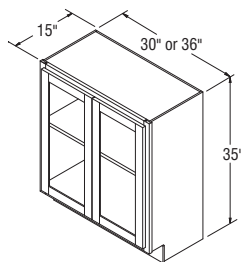

BPG3015FHB
BPG3615FHB

NOTES ✓

- ▶ Cabinets include matching Aristex™ interior and clips to install glass (glass not included).
- ▶ Includes one ¾" thick full depth adjustable shelf.
- ▶ Base Prepped for Glass Cabinets are not available in Augusta, Nantucket, Teagan, or VanWyke.

NOTES ✓

- ▶ Full Extension slide out shelves pull out independently.
- ▶ Smart Stop™ drawer guides are not available on the Pots and Pans Pull-Out in Select and APC Construction.



Base Pots and Pans Pull-Out, 35" High, 24" Wide, 23 3/4" Deep

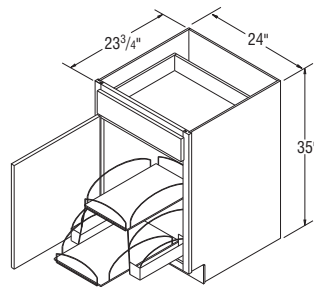

BPPP24

NOTES ✓

- ▶ BWB15FH has one 50-quart wastebasket and small storage tray on Full Extension guides.
- ▶ Natural maple wastebasket support.
- ▶ Smart Stop™ drawer guides are not available in Select and APC Construction.



Base Wastebasket with Full Height Door, 35" High, 23 3/4" Deep

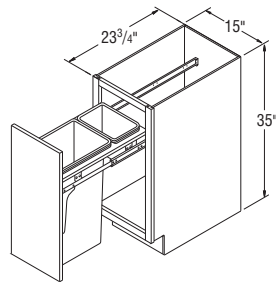

BWB15FH

NOTES ✓

- ▶ BWB18 and BWB21 have two 35-quart Pull-Out wastebaskets on Full Extension guides.
- ▶ Natural maple wastebasket support.
- ▶ Smart Stop™ drawer guides are not available in Select and APC Construction.



Base Wastebaskets, 35" High, 23 3/4" Deep

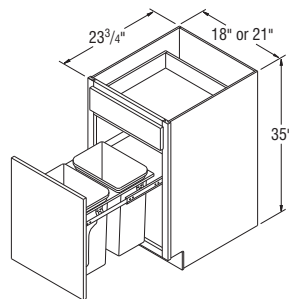

**BWB18
BWB21**

Sink/Range Bases, 35" High, 23 3/4" Deep

NOTES ✓

- ▶ FP = False Panel.
- ▶ It may be necessary to modify the corner braces/stretcher rails with some sink applications.
- ▶ Shelves not included.
- ▶ Front-Onlys are not available in Sink Bases.

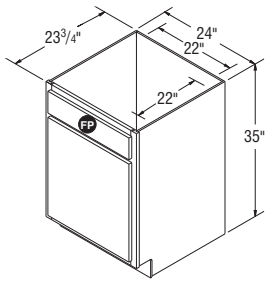

SB24

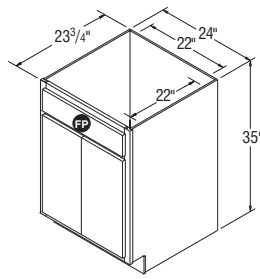

SB24DD

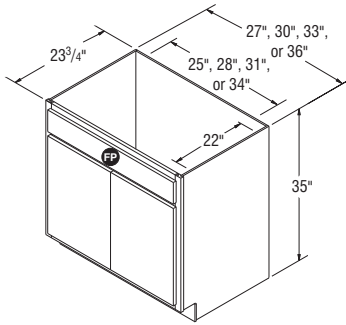

SB27B
SB30B
SB33B
SB36B

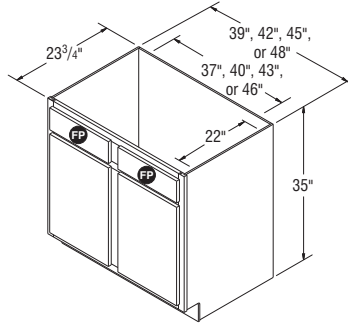

SB39
SB42
SB45
SB48

Sink Base SuperCabinets™ with Reversible Shelf, 35" High, 23 3/4" Deep

NOTES ✓

- ▶ Reversible Shelf is constructed from 3/4" thick laminated furniture board. Shelf shipped secure, can be positioned in left or right corner.
- ▶ Both doors will have a chrome and wood two-tiered rack that is 3 3/4" deep.
- ▶ Includes two installed tip-out trays.
- ▶ Quarter round shelf will be natural maple laminate for all styles, including Glacier Gray, Toasted Antique, and White styles.
- ▶ Soft Close Hinges are not available in Select and APC Construction.

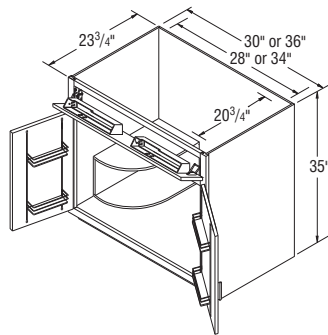

SB30STSB
SB36STSB



NOTES ✓

- ▶ Both doors will have a chrome and wood two-tiered rack that is 3/4" deep.
- ▶ Includes two installed tip-out trays.
- ▶ Soft Close Hinges are not available in Select and APC Construction.



Sink Base SuperCabinets™, 35" High, 23 3/4" Deep

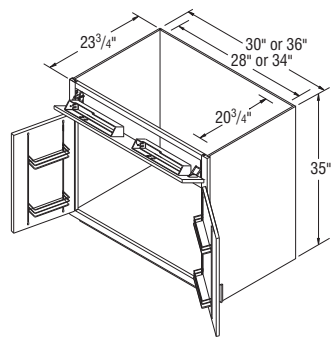

SB30STNSB
SB36STNSB

NOTES ✓

- ▶ It may be necessary to modify the corner braces/stretcher rails with some sink applications.

Country Sink Bases, 35" High, 23 3/4" Deep

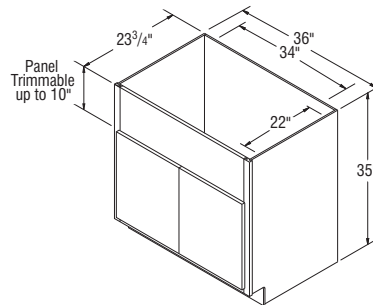

CNTYSB36B

NOTES ✓

- ▶ FP = False Panel.
- ▶ For sufficient dishwasher door clearance and loading/unloading space, a 15" wide base cabinet is recommended for use between sink base diagonal corner cabinet and dishwasher.

Sink Base Diagonal Corner Cabinets, 35" High, 23 3/4" Deep

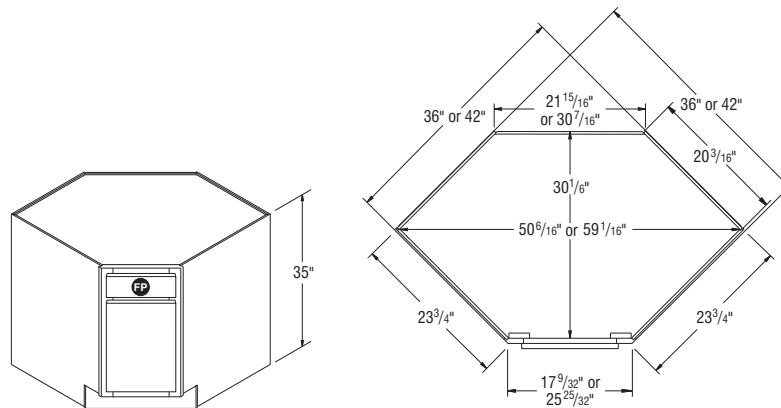

SBDC36
SBDC42

TOP VIEW

	Wall Width	Max. Sink Width
SBDC36	36" x 36"	25 3/4"
SBDC42	42" x 42"	34 1/4"

Sink/Range Fronts, 35" High

NOTES ✓

- ▶ Sink Base floor included with all units.
- ▶ Trimmable 3" each side on partial overlay styles. Not trimmable on full overlay styles.
- ▶ SF30 only available partial overlay styles.
- ▶ SF30B only available full overlay styles.
- ▶ SF42 only available full overlay styles.
- ▶ SF42B only available partial overlay styles.

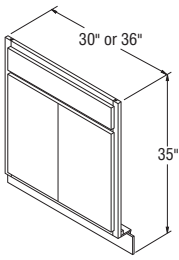

FULL OVERLAY

SF30B
SF36B

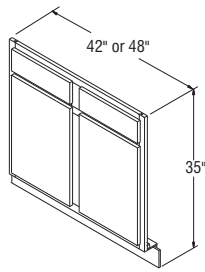

FULL OVERLAY

SF42
SF48

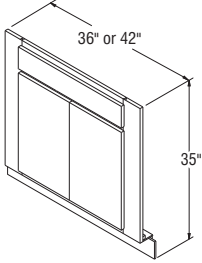

PARTIAL OVERLAY

SF30
SF36B
SF42B

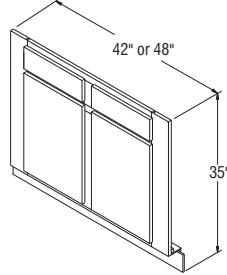

PARTIAL OVERLAY

SF48

Sink Front Corners, 35" High

NOTES ✓

- ▶ Sink Base floor included with all units.
- ▶ Toekick is not attached, ships loose.
- ▶ For sufficient dishwasher door clearance and loading/unloading space, a 15" wide base cabinet is recommended for use between sink base diagonal corner cabinet and dishwasher.
- ▶ Floor dimensions:
SFC36 – $\frac{3}{8}$ " x 36" x 36".
SFC42 – $\frac{3}{8}$ " x 42" x 42".

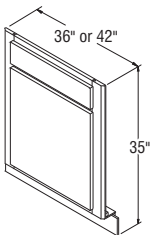

SFC36
SFC42

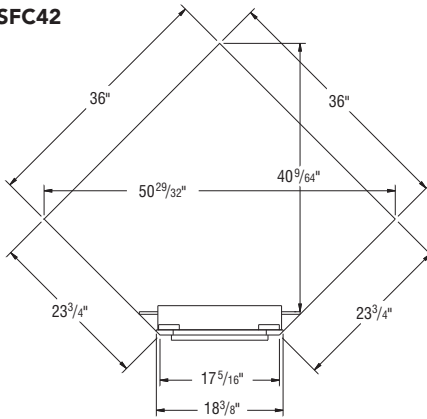

SFC36
TOP VIEW

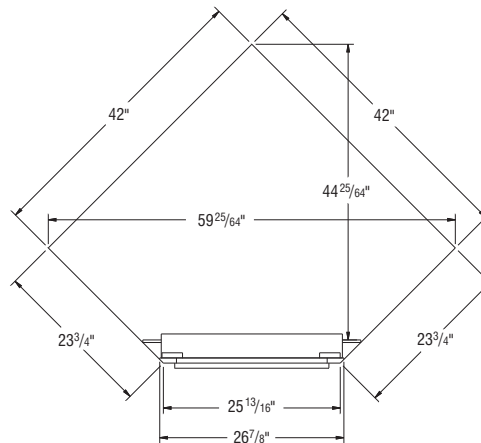

SFC42
TOP VIEW

	Wall Width	Max. Sink Width
SFC36	36" x 36"	25 $\frac{3}{4}$ "
SFC42	42" x 42"	34 $\frac{1}{4}$ "

NOTES ✓

- ▶ DB36-4 is recommended for use with Pegged Dish Organizer (PDO) on page 162. PDO can also be trimmed to fit smaller widths.
- ▶ Raised panel styles - drawer fronts will convert to raised panel; Full Overlay - 10¹/₄" or higher Partial Overlay - 9⁷/₈" or higher
- ★ Standard construction features side-mount Full Extension guides on bottom drawer. Does not feature Smart Stop™. **Select** construction and **APC** feature undermount Full Extension Smart Stop™ guides on bottom drawer.

Four Drawer Bases, 35" High, 23 3/4" Deep

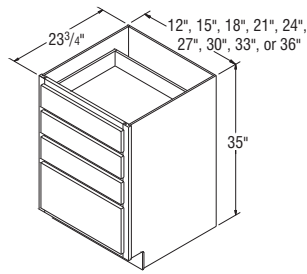

- DB12-4**
- DB15-4**
- DB18-4**
- DB21-4**
- DB24-4**
- DB27-4**
- DB30-4***
- DB33-4***
- DB36-4***

NOTES ✓

- ▶ DB36 is recommended for use with Pegged Dish Organizer (PDO) on page 162. PDO can also be trimmed to fit smaller widths.
- ▶ Raised panel styles - drawer fronts will convert to raised panel; Full Overlay - 10¹/₄" or higher Partial Overlay - 9⁷/₈" or higher
- ★ Standard construction features side-mount Full Extension guides on bottom two drawers. Does not feature Smart Stop™. **Select** construction and **APC** feature undermount Full Extension Smart Stop™ guides on bottom two drawers.

Three Drawer Bases, 35" High, 23 3/4" Deep

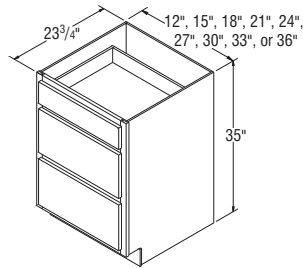

- DB12**
- DB15**
- DB18**
- DB21**
- DB24**
- DB27**
- DB30***
- DB33***
- DB36***

NOTES ✓

- ▶ Cabinet features a false panel to accommodate the install of a cooktop.
- ▶ DBFP36-4 is recommended for use with Pegged Dish Organizer (PDO) on page 162. PDO can also be trimmed to fit DBFP30-4.
- ▶ Raised panel styles - drawer fronts will convert to raised panel; Full Overlay - 10¹/₄" or higher, Partial Overlay - 9⁷/₈" or higher
- ▶ Standard construction features side-mount Full Extension guides on bottom drawer. Does not feature Smart Stop™. **Select** construction and **APC** feature undermount Full Extension Smart Stop™ guides on bottom drawer.
- ▶ Clearance behind drawer box and back of cabinet is approximately 3⁷/₁₆" on PABD drawers and 2⁵/₁₆" on plywood drawers.

Four Drawer Bases with False Panel, 35" High, 23 3/4" Deep

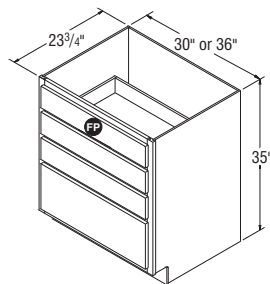

- DBFP30-4**
- DBFP36-4**

Three Drawer Bases with False Panel, 35" High, 23 3/4" Deep

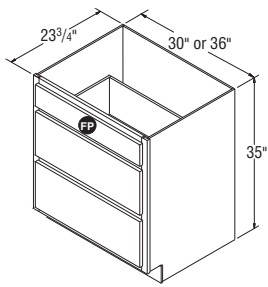

DBFP30
DBFP36

NOTES ✓

- ▶ Cabinet features a false panel to accommodate the install of a cooktop.
- ▶ DBFP36 is recommended for use with Pegged Dish Organizer (PDO) on page 162. PDO can also be trimmed to fit DBFP30.
- ▶ Raised panel styles - drawer fronts will convert to raised panel;
Full Overlay - 10 1/4" or higher
Partial Overlay - 9 7/8" or higher
- ▶ Standard construction features side-mount Full Extension guides on bottom drawers. Does not feature Smart Stop™. **Select** construction and **APC** feature undermount Full Extension Smart Stop™ guides on bottom drawers.
- ▶ Clearance behind drawer box and back of cabinet is approximately 3 5/16" on PABD drawers and 2 5/16" on plywood drawers.

Base Built-In Microwave Cabinet, 35" High, 23 3/4" Deep

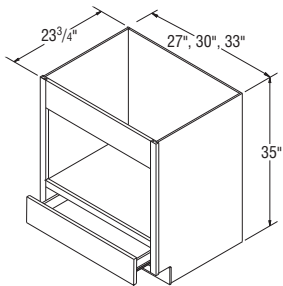

BMW2735
BMW3035
BMW3335

NOTES ✓

- ▶ Microwave opening is trimmable.
- ▶ Refer to line art below for cut-out dimensions.
- ▶ Designed for Built-in Microwaves with trim kits (cabinet has standard Aristex™ natural maple or white interior).

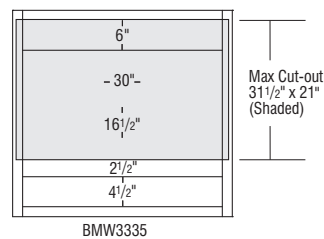
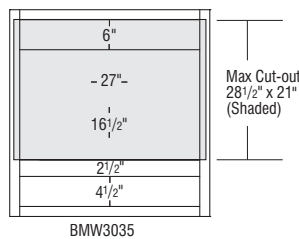
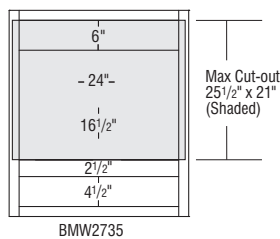

NOTES ✓

- ▶ One knuckle hinge door.
- ▶ Includes magnetic catch.
- ▶ Cannot convert SCER36 to BRER.
- ▶ BRER36 includes two 28" diameter rotating plastic white trays. Each tray has a 60 lb. load capacity
- ▶ BRER: WARNING! The rotating trays in this cabinet are preinstalled and cannot be removed or replaced. Do not stand on, or apply excessive pressure that could cause a tray to crack or break.
- ▶ Decorative hardware must be countersunk to prevent scratching of adjacent cabinets and face frame of SCER/BRER.
- ▶ Soft Close Hinges are not available in Select and APC Construction.



Square Corner/Base Roto Easy Reach Cabinets, 35" High, 23 3/4" Deep

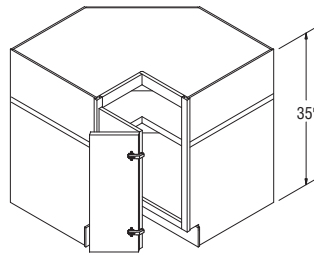

SCER36*

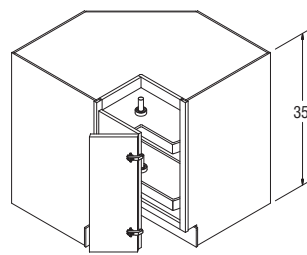

BRER36*

*Specify L or R for full overly styles.

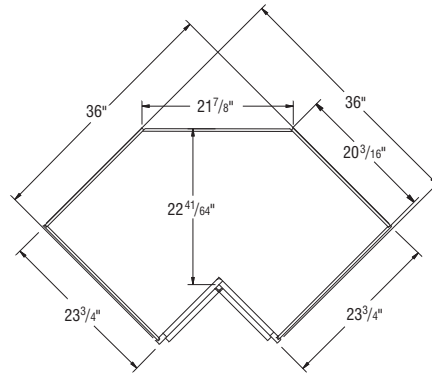

TOP VIEW

NOTES ✓

- ▶ One rotating door.
- ▶ Two rotating white shelves.
- ▶ Nominal gap of 1/4" on all sides of door.
- ▶ SCR33 has 17" diameter shelf and holds 20 lbs. per shelf.
- ▶ SCR36 has 27" diameter shelf and holds 60 lbs. per shelf.
- ▶ APC charges do not apply to SCR cabinets.
- ▶ Soft Close Hinges are not available in Select and APC Construction.



Square Corner Rotos, 35" High

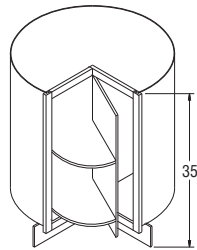

SCR33
SCR36

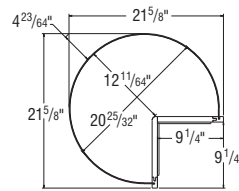

SCR33
TOP VIEW

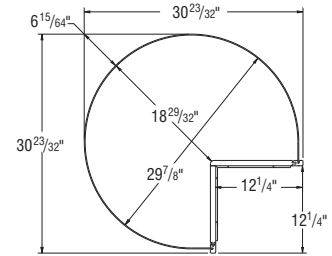

SCR36
TOP VIEW

Base Lazy Susans, 35" High

NOTES ✓

- ▶ One knuckle hinge door.
- ▶ Includes magnetic catch.
- ▶ BLS33 has two 17" diameter rotating plastic white shelves that hold 20 lbs. per shelf.
- ▶ BLS36 has two 27" diameter rotating plastic white shelves that hold 60 lbs. per shelf.
- ▶ Grayson and Nantucket BLS33 doors utilize recessed center panels.
- ▶ APC charges do not apply to BLS cabinets.
- ▶ Soft Close Hinges are not available in Select and APC Construction.

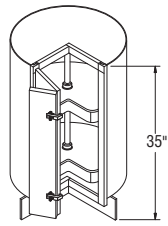

BLS33*

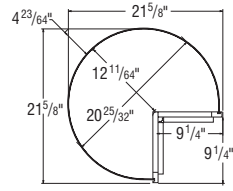

BLS33
TOP VIEW

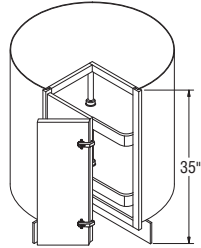

BLS36*

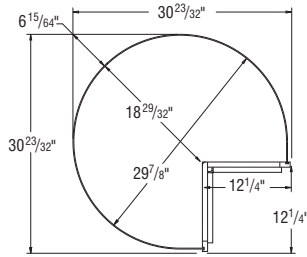

BLS36
TOP VIEW

*Specify L or R for full overlay styles.

Base Corner Cabinet Installation Charts

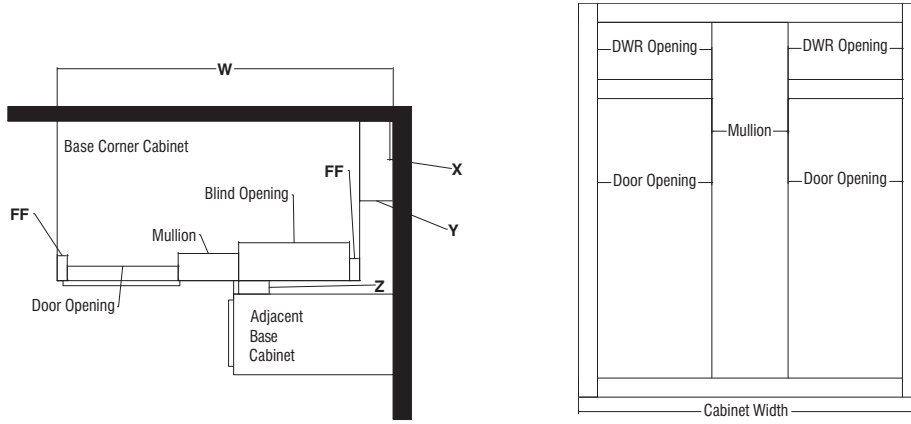

Full Overlay Base Corner Cabinet Information

Full Overlay Styles	Actual Cabinet Width	X		Y	Z		W	
		Min. Pull	Min. Pull w/Hardware	Max. Pull	Min. Filler Required	Min. Filler Required w/Hardware	Min. Pull From Wall To End of Cabinet	Max Pull From Wall To End of Cabinet
BC36	27"	9 ³ / ₄ "	11 ¹ / ₄ "	12 ¹ / ₂ "	1"	2 ¹ / ₂ "	36 ³ / ₄ "	39 ¹ / ₂ "
BC39	30"	6 ³ / ₄ "	8 ¹ / ₄ "	12 ¹ / ₂ "	1"	2 ¹ / ₂ "	36 ³ / ₄ "	42 ¹ / ₂ "
BC42	36"	3 ³ / ₄ "	5 ¹ / ₄ "	9 ¹ / ₂ "	1"	2 ¹ / ₂ "	39 ³ / ₄ "	45 ¹ / ₂ "
BC45	42"	³ / ₄ "	2 ¹ / ₄ "	6 ¹ / ₂ "	1"	2 ¹ / ₂ "	42 ³ / ₄ "	48 ¹ / ₂ "
BC48	45"	0"	³ / ₄ "	5"	1"	2 ¹ / ₂ "	45"	50"
BC51	48"	0"	0"	3 ¹ / ₂ "	1"	2 ¹ / ₂ "	48"	51 ¹ / ₂ "

7/16" Overlay Base Corner Cabinet Information

7/16" Overlay Styles	Actual Cabinet Width	X		Y	Z		W	
		Min. Pull	Min. Pull w/Hardware	Max. Pull	Min. Filler Required	Min. Filler Required w/Hardware	Min. Pull From Wall To End of Cabinet	Max Pull From Wall To End of Cabinet
BC36	27"	9 ¹ / ₄ "	10 ³ / ₄ "	12 ¹ / ₂ "	¹ / ₂ "	2"	36 ¹ / ₄ "	39 ¹ / ₂ "
BC39	30"	6 ¹ / ₄ "	7 ³ / ₄ "	12 ¹ / ₂ "	¹ / ₂ "	2"	36 ¹ / ₄ "	42 ¹ / ₂ "
BC42	36"	3 ¹ / ₄ "	4 ³ / ₄ "	9 ¹ / ₂ "	¹ / ₂ "	2"	39 ¹ / ₄ "	45 ¹ / ₂ "
BC45	42"	¹ / ₄ "	1 ³ / ₄ "	6 ¹ / ₂ "	¹ / ₂ "	2"	42 ¹ / ₄ "	48 ¹ / ₂ "
BC48	45"	0"	¹ / ₄ "	5"	¹ / ₂ "	2"	45"	50"
BC51	48"	0"	0"	3 ¹ / ₂ "	¹ / ₂ "	2	48"	51 ¹ / ₂ "

Base Corner Door, Drawer Front, and Opening Sizes

SKU	7/16" Overlay Door	7/16" Overlay Drawer Front	Full Overlay Door	Full Overlay Door Drawer Front	Door Opening	Drawer Opening
BC36	9 ⁷ / ₈ " x 22 ⁷ / ₈ "	9 ⁷ / ₈ " x 5 ¹ / ₈ "	11 ¹ / ₂ " x 24 ¹ / ₈ "	11 ¹ / ₂ " x 5 ³ / ₄ "	9" x 22"	9" x 4 ¹ / ₂ "
BC39	9 ⁷ / ₈ " x 22 ⁷ / ₈ "	9 ⁷ / ₈ " x 5 ¹ / ₈ "	11 ¹ / ₂ " x 24 ¹ / ₈ "	11 ¹ / ₂ " x 5 ³ / ₄ "	9" x 22"	9" x 4 ¹ / ₂ "
BC42	12 ⁷ / ₈ " x 22 ⁷ / ₈ "	12 ⁷ / ₈ " x 5 ¹ / ₈ "	14 ¹ / ₂ " x 24 ¹ / ₈ "	14 ¹ / ₂ " x 5 ³ / ₄ "	12" x 22"	12" x 4 ¹ / ₂ "
BC45	15 ⁷ / ₈ " x 22 ⁷ / ₈ "	15 ⁷ / ₈ " x 5 ¹ / ₈ "	17 ¹ / ₂ " x 24 ¹ / ₈ "	17 ¹ / ₂ " x 5 ³ / ₄ "	15" x 22"	15" x 4 ¹ / ₂ "
BC48	17 ³ / ₈ " x 22 ⁷ / ₈ "	17 ³ / ₈ " x 5 ¹ / ₈ "	19" x 24 ¹ / ₈ "	19" x 5 ³ / ₄ "	16 ¹ / ₂ " x 22"	16 ¹ / ₂ " x 4 ¹ / ₂ "
BC51	18 ⁷ / ₈ " x 22 ⁷ / ₈ "	18 ⁷ / ₈ " x 5 ¹ / ₈ "	20 ¹ / ₂ " x 24 ¹ / ₈ "	20 ¹ / ₂ " x 5 ³ / ₄ "	18" x 22"	18" x 4 ¹ / ₂ "

Base Corner Cabinets, 35" High, 23 3/4" Deep

NOTES

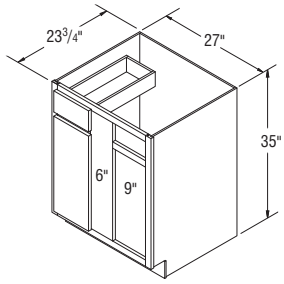

BC36

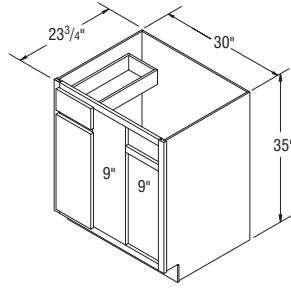

BC39

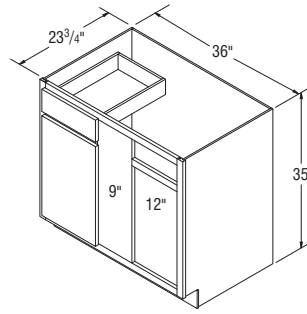

BC42

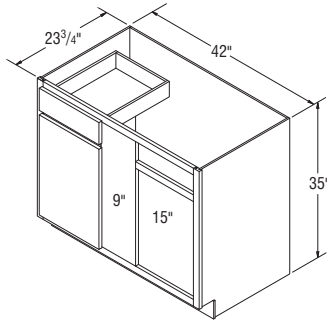

BC45

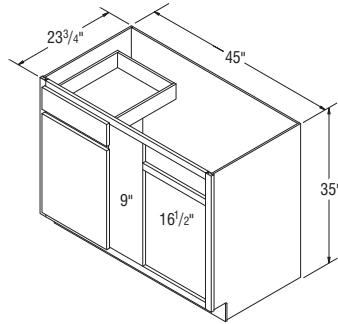

BC48

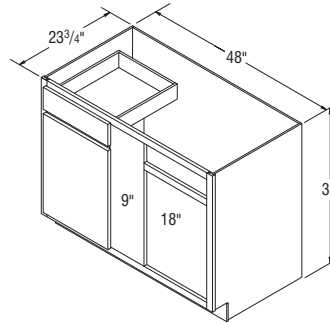

BC51

- ▶ Half-depth fixed shelf included.
- ▶ All Base Corner cabinets are reversible from left blind to right blind.
- ▶ 3" Filler is included with all Base Corner cabinets and shipped under Toekick or in cabinet. Brellin, Briarcliff II, Dryden, Durham, Eastland, Nantucket, Overton, and Wentworth styles come with F331 and OL31.
- ▶ To ensure proper door/drawer clearance, we recommend you do not install appliances next to the blind.
- ▶ One door and one drawer.
- ▶ Cabinets are designed to use same amount of wall space designated in the sku nomenclature.
- ▶ Cover panel shipped with cabinet for field installation to cover blind opening.
- ▶ Reference Installation Charts for proper size and identification. See page 98.

NOTES ✓

- ▶ Two doors.
- ▶ One fixed shelf.
- ▶ Not designed for stand alone island applications.
- ▶ Standard and Select have laminate, non-matching sides.
- ▶ APC sides are unfinished.



Base End Cabinet, 35" High, 23 3/4" Deep

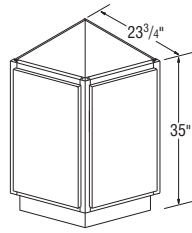

BECF24

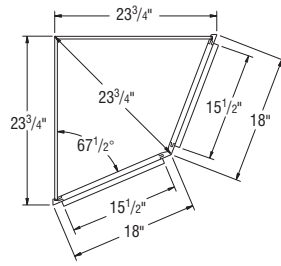

TOP VIEW

NOTES ✓

- ▶ Includes one 12" deep fixed shelf.
- ▶ 23 3/4" side is unfinished in APC only.



Base End Cabinet, 35" High, 12" Wide, 23 3/4" Deep

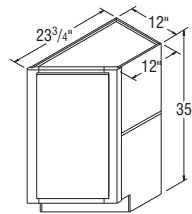

BEC12*



BEC12R
TOP VIEW

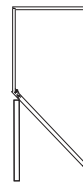

BEC12L
TOP VIEW

*L or R designation specifies 12" deep side and door hinging.

Peninsula Base Cabinets, 35" High, 23 3/4" Deep

NOTES ✓

- ▶ Reversible units with one full-depth, 3/4" thick, plywood fixed shelf in all construction platforms.
- ▶ Peninsula cabinets not designed to be used as stand alone island cabinets.
- ▶ PB18 and PB24 have two doors, one drawer, and one drawer front.
- ▶ PB24DD has four doors, one drawer, and one drawer front.
- ▶ PB42–PB48 have four doors, two drawers, and two drawer fronts.
- ▶ PB30B–PB36B have four doors (two sets of butt doors), one drawer, and one drawer front.

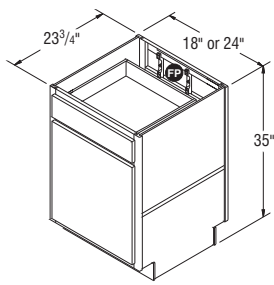

**PB18
PB24**

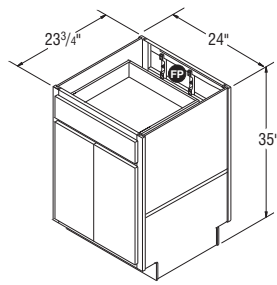

PB24DD

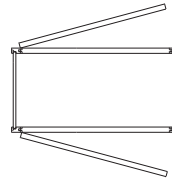

TOP VIEW

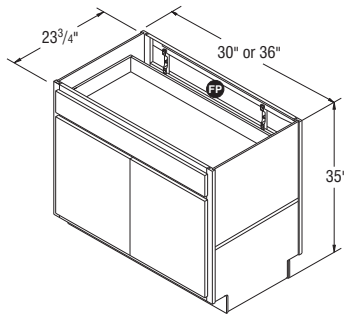

**PB30B
PB36B**

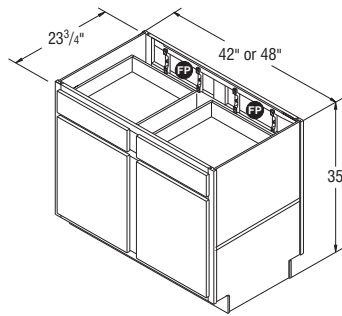

**PB42
PB48**

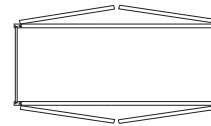

TOP VIEW

Peninsula Base Square Corner Cabinets, 35" High, 23 3/4" Deep

NOTES ✓

- ▶ 3" Filler is included.
- ▶ Reversible units with one full-depth fixed shelf.
- ▶ Peninsula cabinets not designed to be used as stand alone island cabinets. installation.

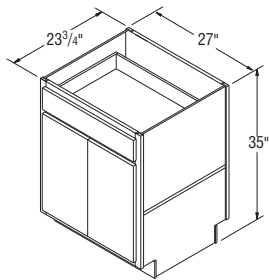

BACK VIEW

PBSC27B

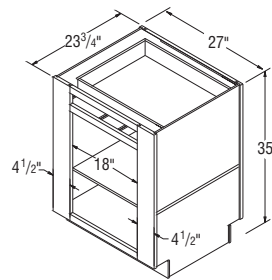

FRONT VIEW

PBSC27B

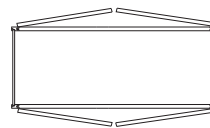

TOP VIEW

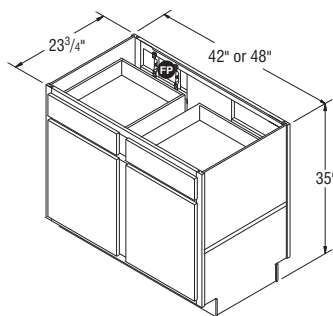

BACK VIEW

**PBSC42
PBSC48**

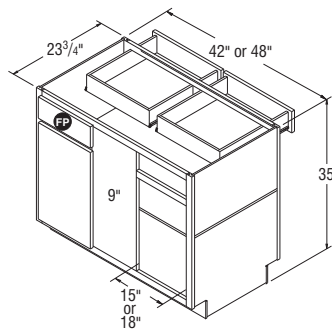

FRONT VIEW

**PBSC42
PBSC48**

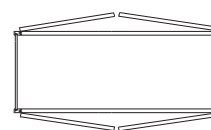

TOP VIEW

Peninsula Base Square Corner Cabinet Information

KEY

- X: Minimum pull for Square Corner cabinets.
- Y: Maximum pull for Square Corner cabinets.
- Z: Minimum filler size required between cabinets.
- ▶ Minimum pull figured when Square Corner Wall or adjacent cabinet doors can open 90 degrees.

Full Overlay Styles	X		Y	Z	
	Min. Pull	Min. Pull w/Hardware	Max. Pull	Min. Filler Required	Min. Filler Required w/Hardware
PBSC27B	0"	0"	1/2"	1"	2 1/2"
PBSC42	3/4"	2 1/4"	6 1/2"	1"	2 1/2"
PBSC48	0"	3/4"	5"	1"	2 1/2"

7/16" Overlay Styles	X		Y	Z	
	Min. Pull	Min. Pull w/Hardware	Max. Pull	Min. Filler Required	Min. Filler Required w/Hardware
PBSC27B	0"	0"	1/2"	1/2"	2"
PBSC42	1/4"	1 3/4"	6 1/2"	1/2"	2"
PBSC48	0"	1/4"	5"	1/2"	2"

Oven Cabinets, 84" High, 23 3/4" Deep

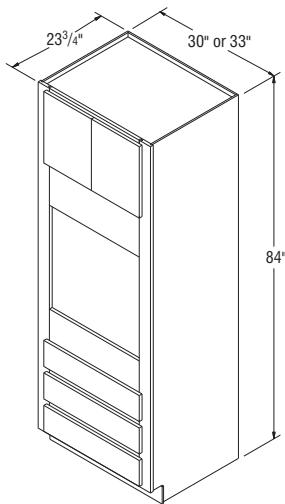

OCSD30B *New*
OCSD33B *New*

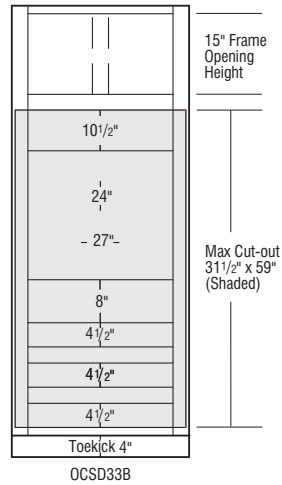
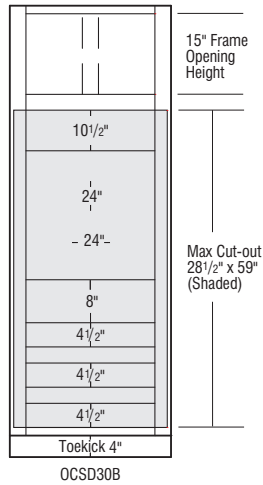

NOTES ✓

- ▶ Two doors and three drawers.
- ▶ Oven shelf support kit included.
- ▶ For OCINSTALLKIT, see page 164.
- ▶ Shelves not available on this cabinet.
- ▶ Back of cabinet scored for easy back removal if needed when oven used is deeper than cabinet can accommodate.
- ▶ Cabinet features concealed face mount hinges.

DESIGN SOLUTIONS

- ▶ Be sure to confirm a heat shield is built into your appliance by the manufacturer or install the heat shield included with your appliance.
- ▶ Oven cabinets are trimmable to accommodate a variety of appliance sizes.

Oven Cabinets, 90" High, 23 3/4" Deep

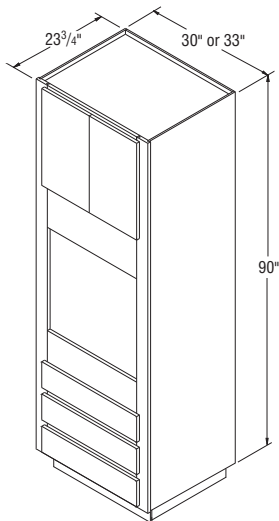

OCSD3090B *New*
OCSD3390B *New*

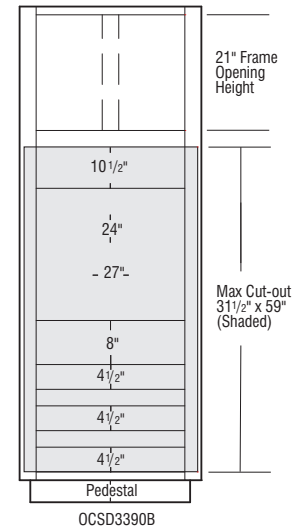
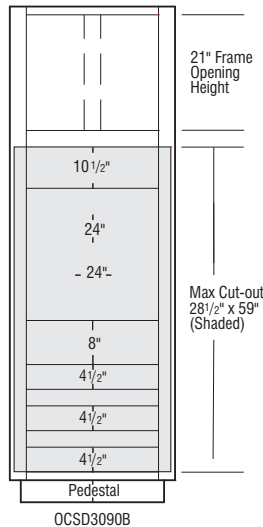

NOTES ✓

- ▶ Two doors and three drawers.
- ▶ Oven shelf support kit included.
- ▶ For OCINSTALLKIT, see page 164.
- ▶ All 90" cabinets are shipped as an 86" cabinet with unfinished Loose ToeKick Sub Assembly unattached.
- ▶ Additional material may be needed to cover unfinished Loose ToeKick Sub Assembly.
- ▶ Shelves not available on this cabinet.
- ▶ Refer to Loose ToeKick Sub Assembly Installation instructions for cabinet installation.
- ▶ Back of cabinet scored for easy back removal if needed when oven used is deeper than cabinet can accommodate.
- ▶ Cabinet features concealed face mount hinges.

DESIGN SOLUTIONS

- ▶ Be sure to confirm a heat shield is built into your appliance by the manufacturer or install the heat shield included with your appliance.
- ▶ Oven cabinets are trimmable to accommodate a variety of appliance sizes.

NOTES ✓

- ▶ Two doors, one adjustable shelf, and three drawers.
- ▶ Oven shelf support kit included.
- ▶ For OCINSTALLKIT, see page 164.
- ▶ All 96" cabinets are shipped as a 92" cabinet with unfinished Loose Toekick Sub Assembly unattached.
- ▶ Additional material may be needed to cover unfinished Loose Toekick Sub Assembly.
- ▶ Refer to Loose Toekick Sub Assembly Installation instructions for cabinet installation.
- ▶ Back of cabinet scored for easy back removal if needed when oven used is deeper than cabinet can accommodate.
- ▶ Cabinet features concealed face mount hinges.

DESIGN SOLUTIONS

- ▶ Be sure to confirm a heat shield is built into your appliance by the manufacturer or install the heat shield included with your appliance.
- ▶ Oven cabinets are trimmable to accommodate a variety of appliance sizes.

Oven Cabinets, 96" High, 23 3/4" Deep

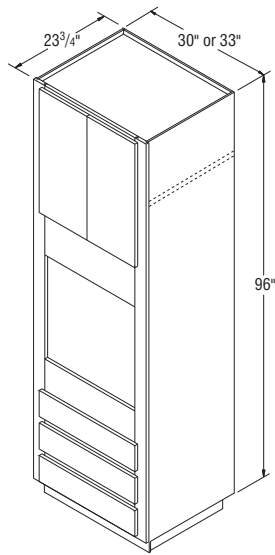

OCSD3096B *New*
OCSD3396B *New*

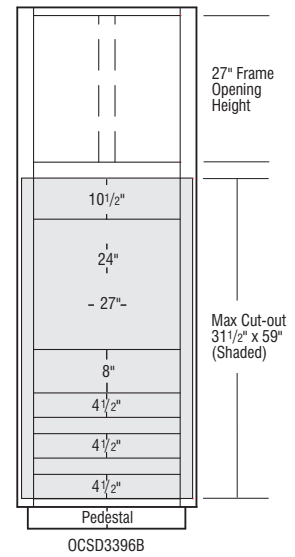
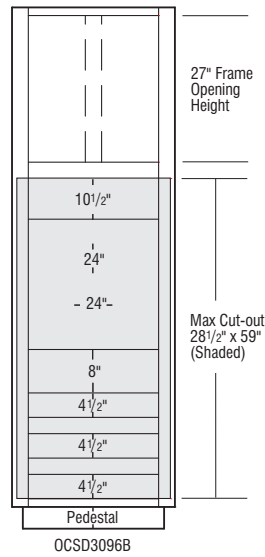

Oven Cabinets Double, 84" High, 23 3/4" Deep

NOTES ✓

- ▶ Two doors and one drawer.
- ▶ Oven shelf support kit included.
- ▶ For OCINSTALLKIT, see page 164.
- ▶ Back of cabinet scored for easy back removal if needed when oven used is deeper than cabinet can accommodate.
- ▶ Cabinet features concealed face mount hinges.

DESIGN SOLUTIONS

- ▶ Be sure to confirm a heat shield is built into your appliance by the manufacturer or install the heat shield included with your appliance.
- ▶ Oven cabinets are trimmable to accommodate a variety of appliance sizes.

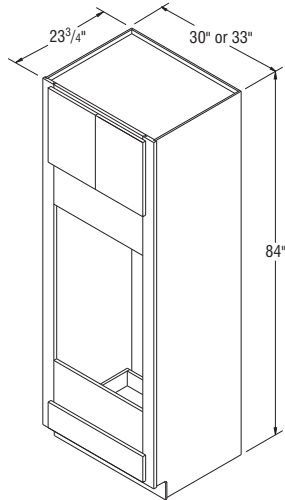

OD30B *New*
OD33B *New*

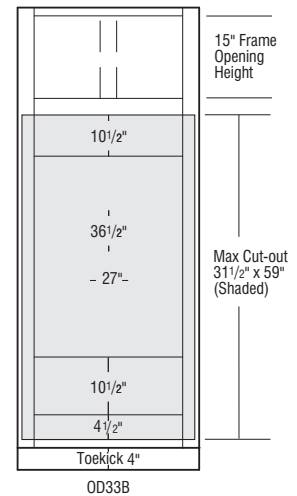
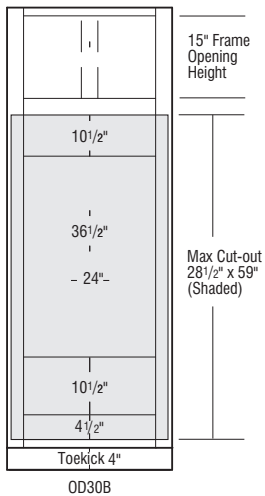

Oven Cabinets Double, 90" High, 23 3/4" Deep

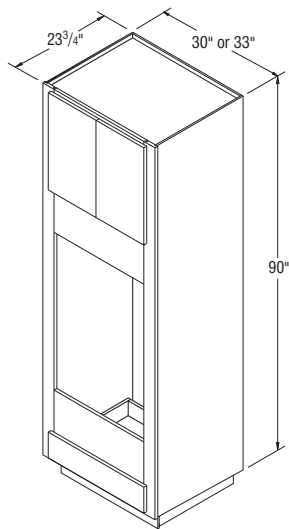

OD3090B *New*
OD3390B *New*

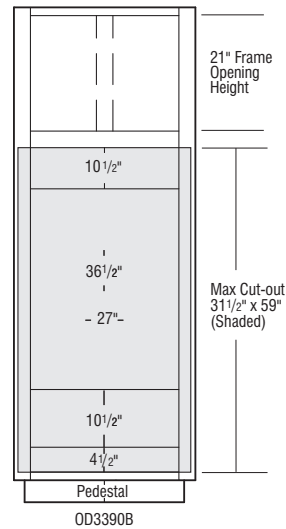
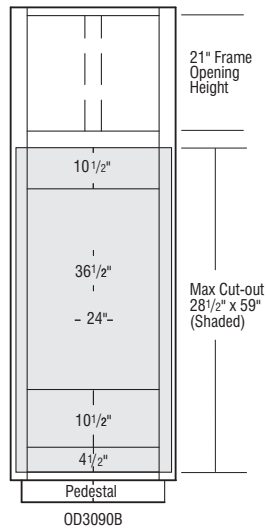

NOTES ✓

- ▶ Two doors and one drawer.
- ▶ Oven shelf support kit included.
- ▶ For OCINSTALLKIT, see page 164.
- ▶ All 90" cabinets are shipped as an 86" cabinet with unfinished Loose Toekick Sub Assembly unattached.
- ▶ Additional material may be needed to cover unfinished Loose Toekick Sub Assembly.
- ▶ Refer to Loose Toekick Sub Assembly Installation instructions for cabinet installation.
- ▶ Back of cabinet scored for easy back removal if needed when oven used is deeper than cabinet can accommodate.
- ▶ Cabinet features concealed face mount hinges.

DESIGN SOLUTIONS

- ▶ Be sure to confirm a heat shield is built into your appliance by the manufacturer or install the heat shield included with your appliance.
- ▶ Oven cabinets are trimmable to accommodate a variety of appliance sizes.

Oven Cabinets Double, 96" High, 23 3/4" Deep

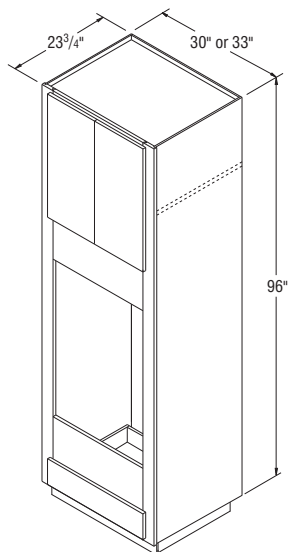

OD3096B *New*
OD3396B *New*

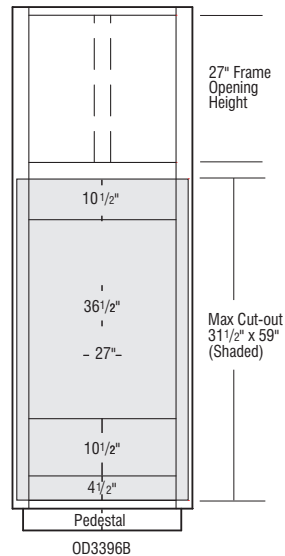
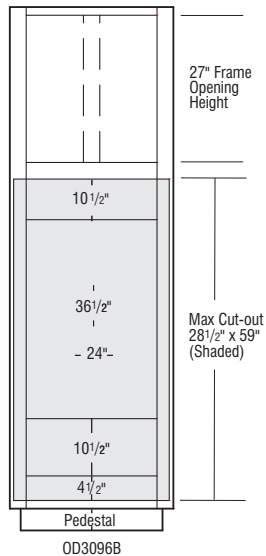

NOTES ✓

- ▶ Two doors, one adjustable shelf, and one drawer.
- ▶ Oven shelf support kit included.
- ▶ For OCINSTALLKIT, see page 164.
- ▶ All 96" cabinets are shipped as a 92" cabinet with unfinished Loose Toekick Sub Assembly unattached.
- ▶ Additional material may be needed to cover unfinished Loose Toekick Sub Assembly.
- ▶ Refer to Loose Toekick Sub Assembly Installation instructions for cabinet installation.
- ▶ Back of cabinet scored for easy back removal if needed when oven used is deeper than cabinet can accommodate.
- ▶ Cabinet features concealed face mount hinges.

DESIGN SOLUTIONS

- ▶ Be sure to confirm a heat shield is built into your appliance by the manufacturer or install the heat shield included with your appliance.
- ▶ Oven cabinets are trimmable to accommodate a variety of appliance sizes.

NOTES ✓

- ▶ Two doors above microwave, one drawer and two doors below microwave.
- ▶ Back of cabinet scored for easy back removal if needed when oven used is deeper than cabinet can accommodate.
- ▶ Drawer aligns with a standard 35" high Base cabinet.
- ▶ Upper doors align with a 24" high Wall Cabinet.

DESIGN SOLUTIONS

- ▶ Be sure to confirm a heat shield is built into your appliance by the manufacturer or install the heat shield included with your appliance.
- ▶ Microwave cabinets are trimmable to accommodate a variety of appliance sizes.

Microwave Cabinets, 84" High, 23 3/4" Deep

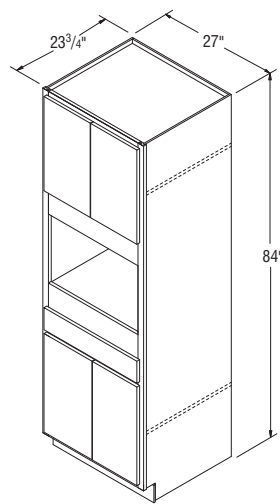

TMW27B *New*

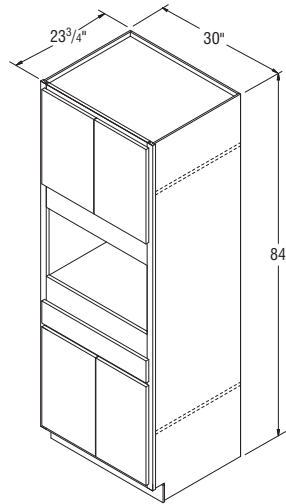

TMW30B *New*

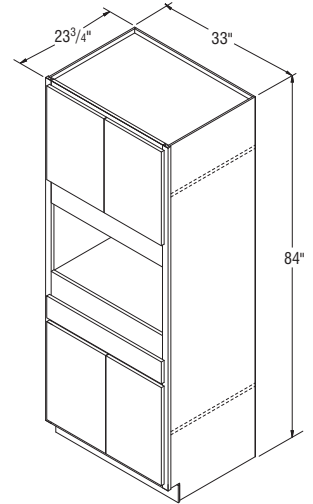

TMW33B *New*

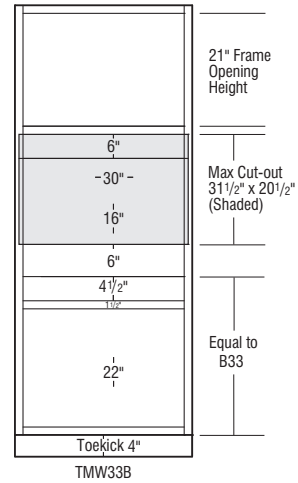
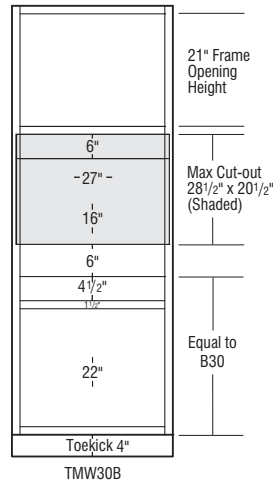
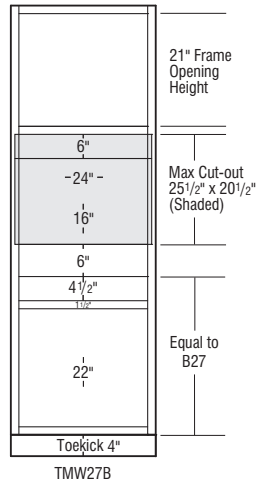

Microwave Cabinets, 90" High, 23 3/4" Deep

NOTES

- ▶ Two doors above microwave, one drawer and two doors below microwave.
- ▶ All 90" cabinets are shipped as an 86" cabinet with unfinished Loose Toekick Sub Assembly unattached.
- ▶ Additional material may be needed to cover unfinished Loose Toekick Sub Assembly.
- ▶ Refer to Loose Toekick Sub Assembly Installation instructions for cabinet installation.
- ▶ Back of cabinet scored for easy back removal if needed when oven used is deeper than cabinet can accommodate.
- ▶ Drawer aligns with a standard 35" high Base cabinet.
- ▶ Upper doors align with a 24" high Wall Cabinet.

DESIGN SOLUTIONS

- ▶ Be sure to confirm a heat shield is built into your appliance by the manufacturer or install the heat shield included with your appliance.
- ▶ Microwave cabinets are trimmable to accommodate a variety of appliance sizes.

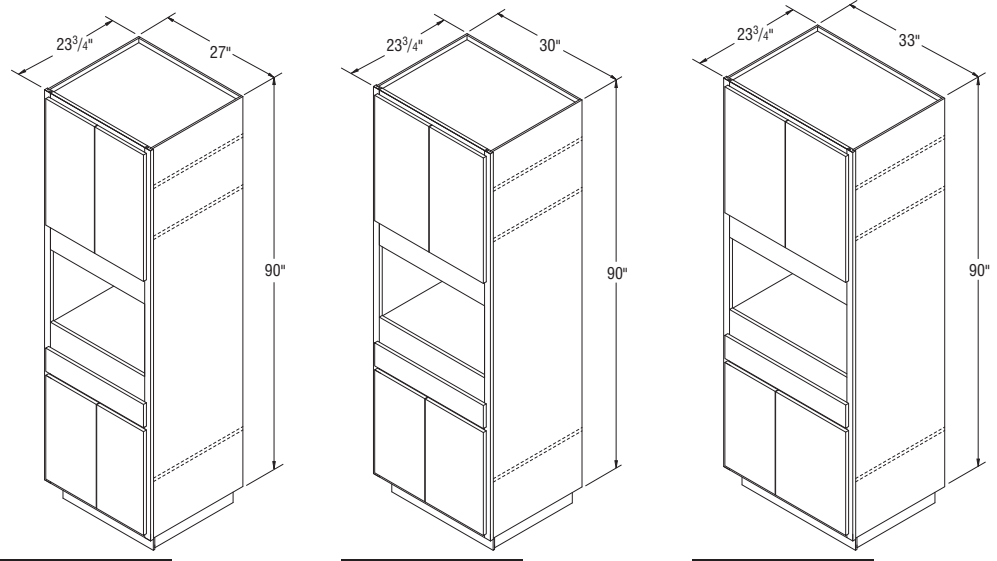

TMW2790B *New*

TMW3090B *New*

TMW3390B *New*

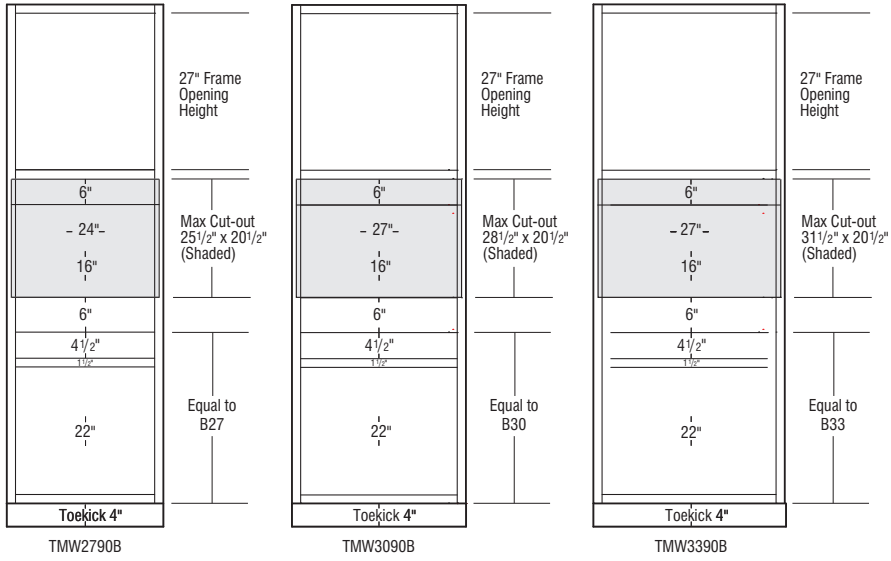

TALL CABINETS

NOTES ✓

- ▶ Two doors above microwave, one drawer and two doors below microwave.
- ▶ All 96" cabinets are shipped as an 92" cabinet with unfinished Loose Toekick Sub Assembly unattached.
- ▶ Additional material may be needed to cover unfinished Loose Toekick Sub Assembly.
- ▶ Refer to Loose Toekick Sub Assembly Installation instructions for cabinet installation.
- ▶ Back of cabinet scored for easy back removal if needed when oven used is deeper than cabinet can accommodate.
- ▶ Drawer aligns with a standard 35" high Base cabinet.
- ▶ Upper doors align with a 24" high Wall Cabinet.

DESIGN SOLUTIONS

- ▶ Be sure to confirm a heat shield is built into your appliance by the manufacturer or install the heat shield included with your appliance.
- ▶ Microwave cabinets are trimmable to accommodate a variety of appliance sizes.

Microwave Cabinets, 96" High, 23 3/4" Deep

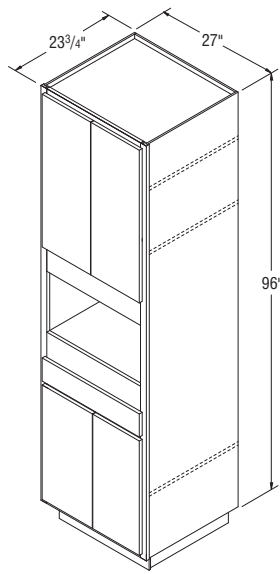

TMW2796B *New*

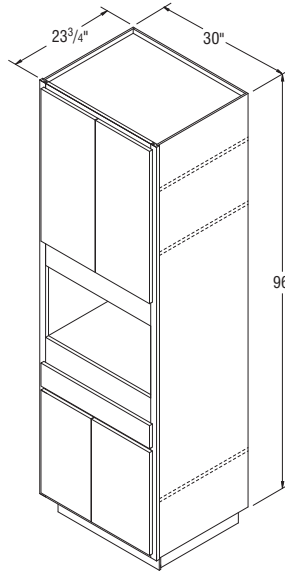

TMW3096B *New*

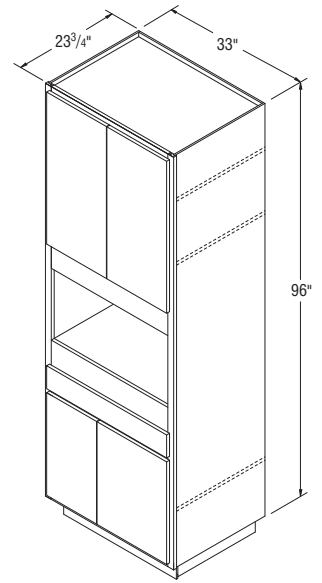

TMW3396B *New*

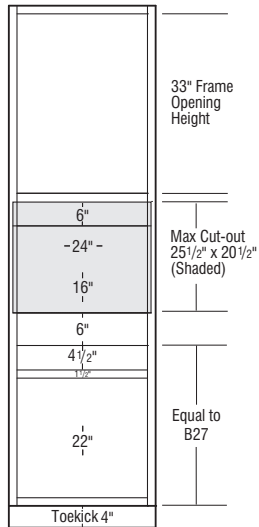

TMW2796B

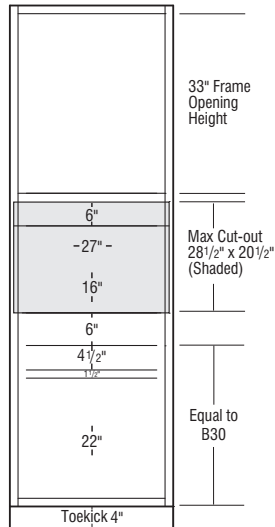

TMW3096B

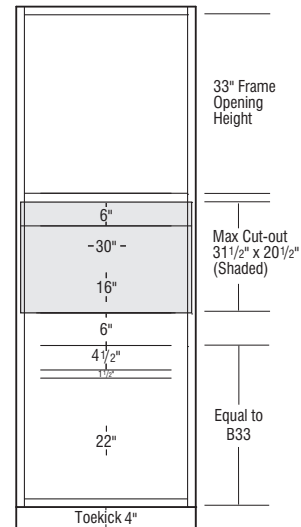

TMW3396B

Oven with Microwave Cabinets, 84" High, 23 3/4" Deep

NOTES ✓

- ▶ Two doors above the microwave and one deep drawer below the oven.
- ▶ Oven shelf support kit included (OCINSTALLKIT).
- ▶ For OCINSTALLKIT see page 164.
- ▶ Back of cabinet scored for easy back removal if needed when oven used is deeper than cabinet can accommodate.

DESIGN SOLUTIONS

- ▶ Be sure to confirm a heat shield is built into your appliance by the manufacturer or install the heat shield included with your appliance.
- ▶ Oven cabinets are trimmable to accommodate a variety of appliance sizes.

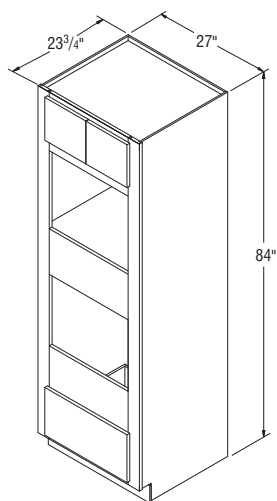

OMS27DDB *New*

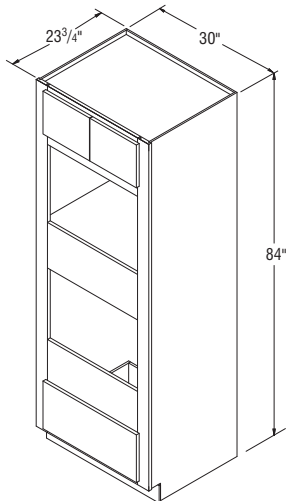

OMS30DDB *New*

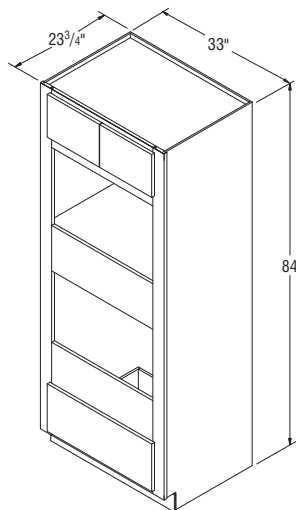

OMS33DDB *New*

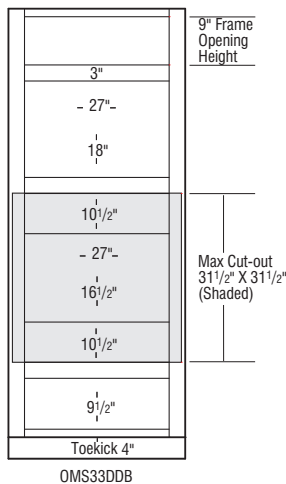
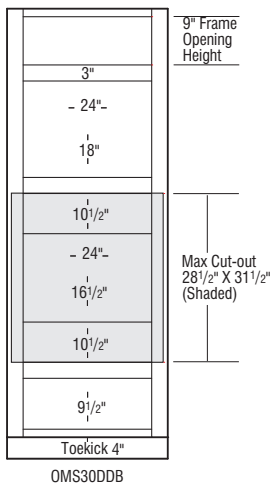
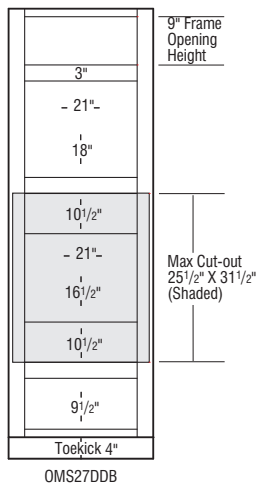

NOTES ✓

- ▶ Two doors above microwave, one deep drawer below oven.
- ▶ Oven shelf support kit included (OCINSTALLKIT).
- ▶ For OCINSTALLKIT, see page 164.
- ▶ All 90" cabinets are shipped as an 86" cabinet with unfinished Loose Toekick Sub Assembly unattached.
- ▶ Additional material may be needed to cover unfinished Loose Toekick Sub Assembly.
- ▶ Refer to Loose Toekick Sub Assembly Installation instructions for cabinet installation.
- ▶ Back of cabinet scored for easy back removal if needed when oven used is deeper than cabinet can accommodate.

DESIGN SOLUTIONS

- ▶ Be sure to confirm a heat shield is built into your appliance by the manufacturer or install the heat shield included with your appliance.
- ▶ Oven cabinets are trimmable to accommodate a variety of appliance sizes.

Oven with Microwave Cabinets, 90" High, 23 3/4" Deep

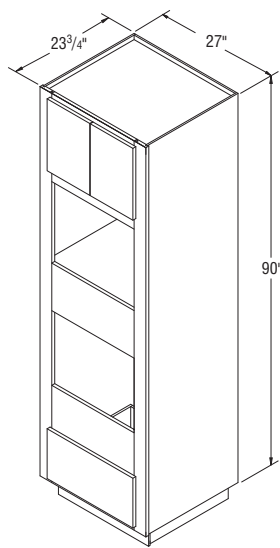

OMS2790DDB *New*

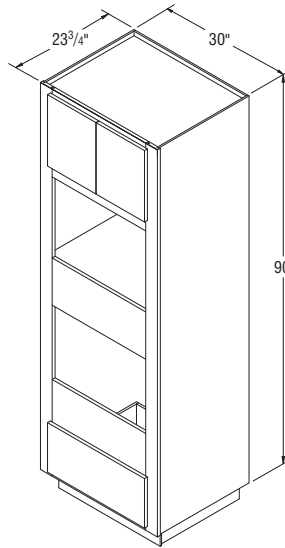

OMS3090DDB *New*

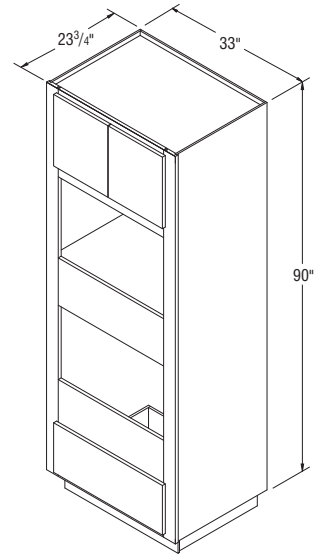

OMS3390DDB *New*

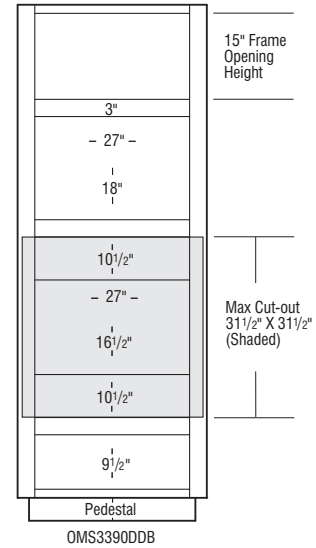
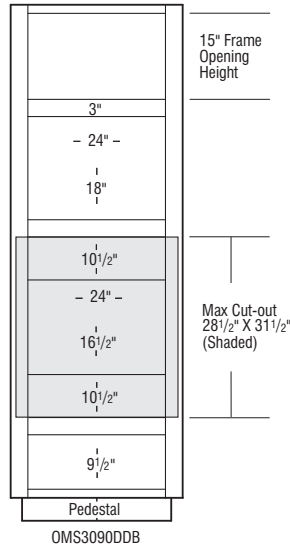
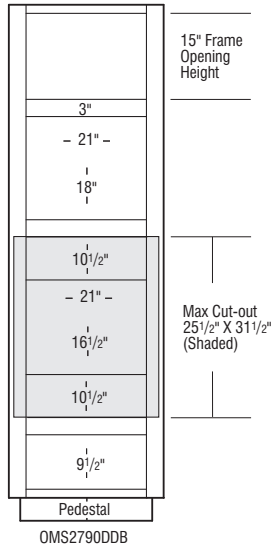

Oven with Microwave Cabinets, 96" High, 23 3/4" Deep

NOTES ✓

- ▶ Two doors above microwave, one deep drawer below oven.
- ▶ Oven shelf support kit included (OCINSTALLKIT).
- ▶ For OCINSTALLKIT, see page 164.
- ▶ All 96" cabinets are shipped as an 92" cabinet with unfinished Loose Toekick Sub Assembly unattached.
- ▶ Additional material may be needed to cover unfinished Loose Toekick Sub Assembly.
- ▶ Refer to Loose Toekick Sub Assembly Installation instructions for cabinet installation.
- ▶ Back of cabinet scored for easy back removal if needed when oven used is deeper than cabinet can accommodate.

DESIGN SOLUTIONS

- ▶ Be sure to confirm a heat shield is built into your appliance by the manufacturer or install the heat shield included with your appliance.
- ▶ Oven cabinets are trimmable to accommodate a variety of appliance sizes.

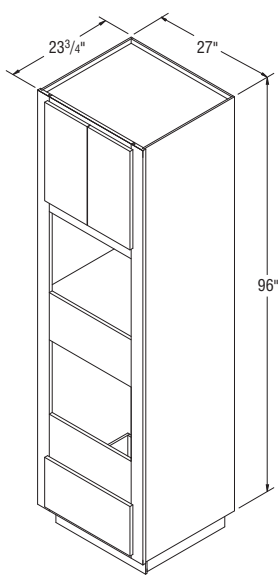

OMS2796DDB *New*

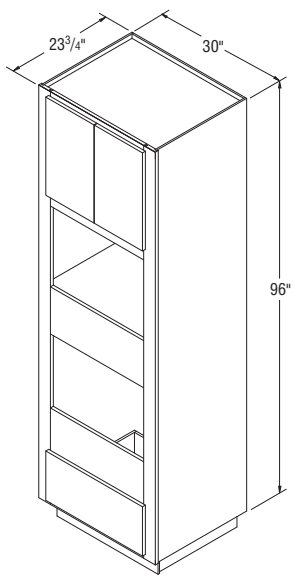

OMS3096DDB *New*

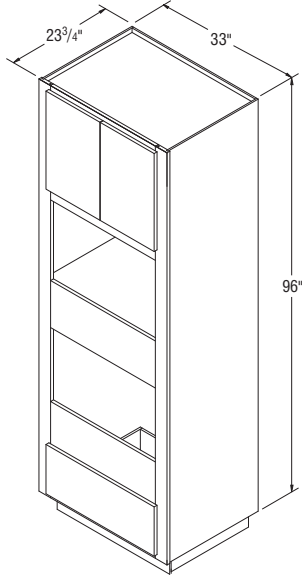

OMS3396DDB *New*

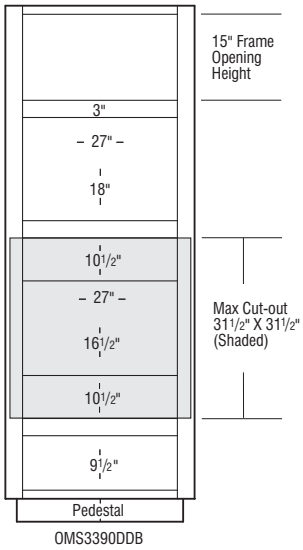
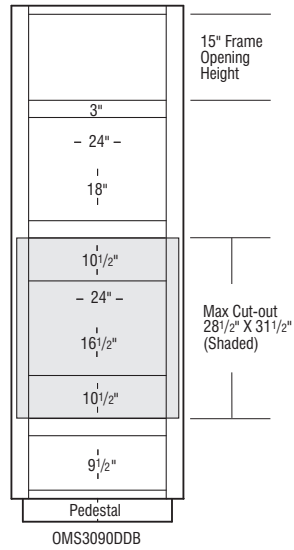
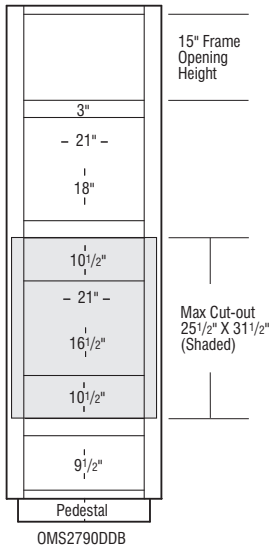

NOTES ✓

- ▶ Two reduced depth $\frac{3}{4}$ " thick adjustable shelves in top section.
- ▶ Each upper door features two adjustable height door racks.
- ▶ Four adjustable height Roll Trays in bottom section.
- ▶ Upgrade charges do not include Roll Trays.
- ▶ Large openings on miter styles will be two doors doweled together.
- ▶ Refer to the Cabinet Specifications Section for door opening dimensions.
- ▶ Smart Stop™ drawer guides are not available on Roll Trays in Select and APC Construction.

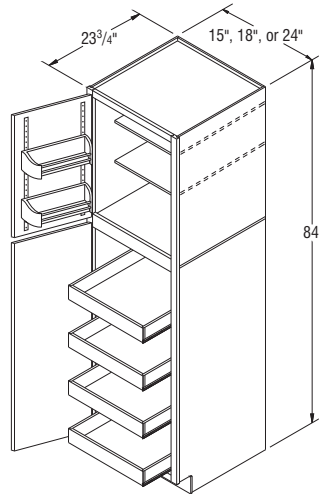
Pantry SuperCabinets™, 84" High, 23 $\frac{3}{4}$ " Deep

PSC15*
PSC18*
PSC24*

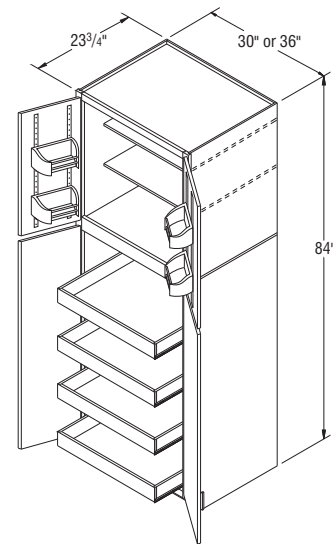

PSC30B
PSC36B

*Specify L or R on all single door Pantry SuperCabinets.

NOTES ✓

- ▶ Two reduced depth $\frac{3}{4}$ " thick adjustable shelves in top section.
- ▶ Each upper door features two adjustable height door racks.
- ▶ Four adjustable height Roll Trays in bottom section.
- ▶ Upgrade charges do not include Roll Trays.
- ▶ Large openings on miter styles will be two doors doweled together.
- ▶ All 90" Pantry SuperCabinets™ are shipped as a 86" cabinet with unfinished Loose Toekick Sub Assembly.
- ▶ Additional material may be needed to cover unfinished Loose Toekick Sub Assembly
- ▶ Refer to the Cabinet Specifications Section for door opening dimensions.
- ▶ Refer to Loose Toekick Sub Assembly Installation instructions for cabinet installation.
- ▶ Smart Stop™ drawer guides are not available on Roll Trays in Select and APC Construction.

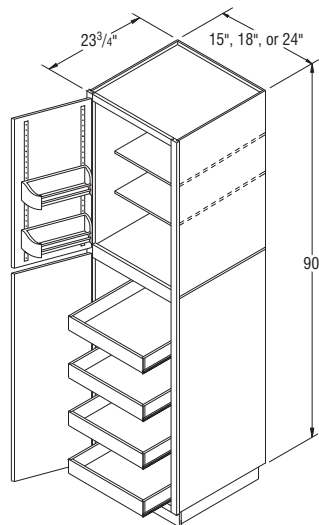
Pantry SuperCabinets™, 90" High, 23 $\frac{3}{4}$ " Deep

PSC1590*
PSC1890*
PSC2490*

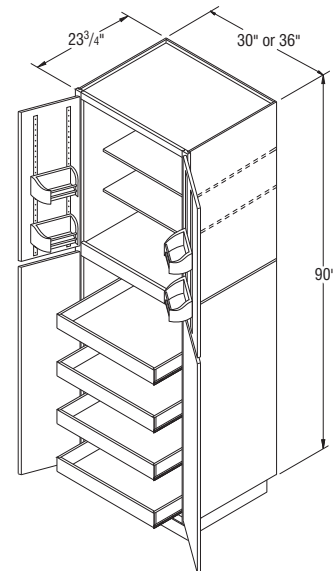

PSC3090B
PSC3690B

*Specify L or R on all single door Pantry SuperCabinets.

Pantry SuperCabinets™, 96" High, 23 3/4" Deep

NOTES ✓

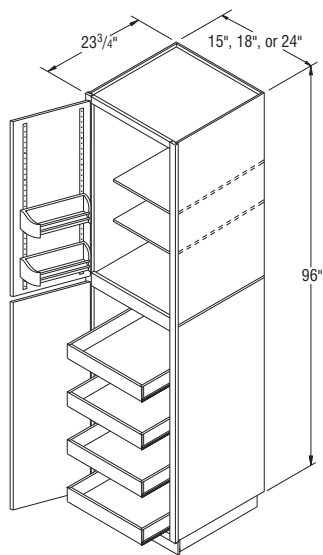

PSC1596*
PSC1896*
PSC2496*

*Specify L or R on all single door Pantry SuperCabinets.

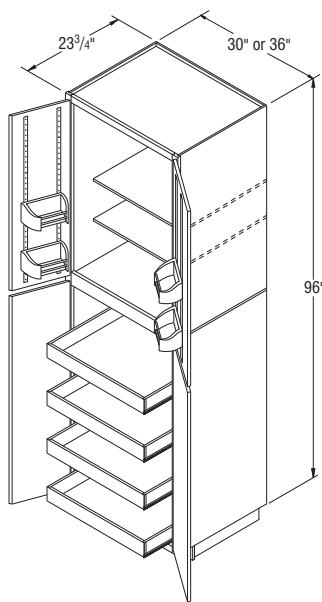

PSC3096B
PSC3696B

- ▶ Two reduced depth 3/4" thick adjustable shelves in top section.
- ▶ Each upper door features two adjustable height door racks.
- ▶ Four adjustable height Roll Trays in bottom section.
- ▶ Upgrade charges do not include Roll Trays.
- ▶ Large openings on miter styles will be two doors doweled together.
- ▶ All 96" Pantry SuperCabinets™ are shipped as a 92" cabinet with unfinished Loose Toekick Sub Assembly.
- ▶ Additional material may be needed to cover unfinished Loose Toekick Sub Assembly.
- ▶ Refer to the Cabinet Specifications Section for door opening dimensions.
- ▶ Refer to Loose Toekick Sub Assembly Installation instructions for cabinet installation.
- ▶ Smart Stop™ drawer guides are not available on Roll Trays in Select and APC Construction.



NOTES ✓

- ▶ 84" high Utility cabinets include one fixed shelf between doors.
- ▶ Large openings on miter styles will be two doors doweled together.
- ▶ Shelves not included in Utility cabinets. For shelf and Roll Tray options see pages 165-166.
- ▶ Refer to the Cabinet Specifications Section for door opening dimensions.



Utility Cabinets, 84" High, 12" and 23 3/4" Deep

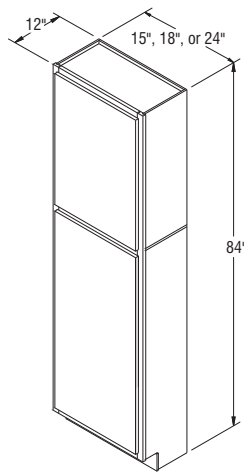

U1512*
U1812*
U2412*

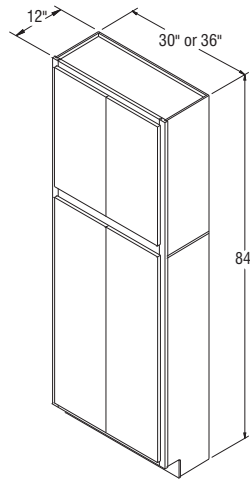

U3012B
U3612B

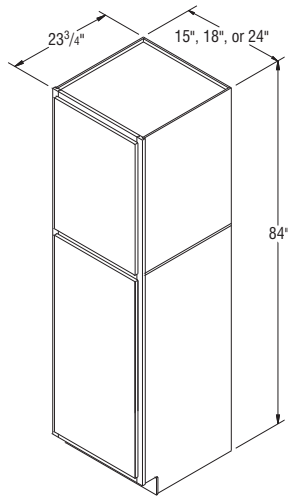

U15*
U18*
U24*

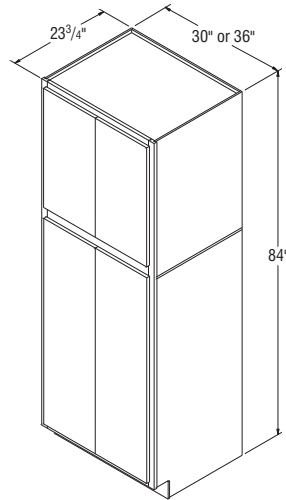

U30B
U36B

*Specify L or R on all single door Utility Cabinets.

Utility Cabinets, 90" High, 12" and 23 3/4" Deep

NOTES ✓

- ▶ 90" high Utility cabinets include one fixed shelf between doors.
- ▶ Large openings on miter styles will be two doors doweled together.
- ▶ Shelves not included in Utility cabinets. For shelf and Roll Tray options see pages 165-166.
- ▶ All 90" high Utility cabinets are shipped as an 86" cabinet with unfinished Loose Toekick Sub Assembly.
- ▶ Additional material may be needed to cover unfinished Loose Toekick Sub Assembly.
- ▶ Refer to the Cabinet Specifications Section for door opening dimensions.
- ▶ Refer to Loose Toekick Sub Assembly Installation instructions for cabinet installation.

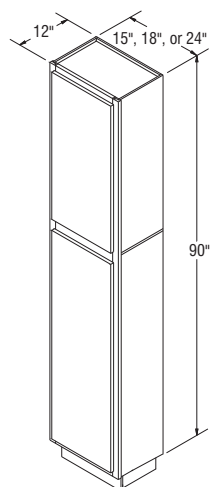

U159012*
U189012*
U249012*

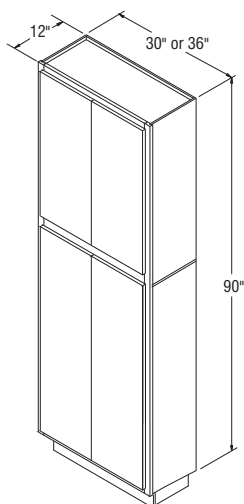

U309012B
U369012B

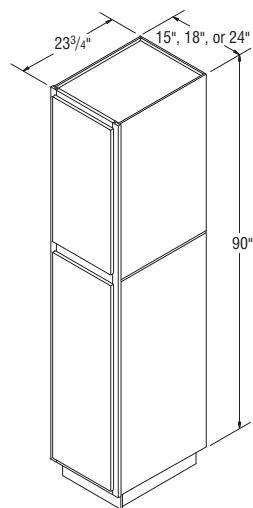

U1590*
U1890*
U2490*

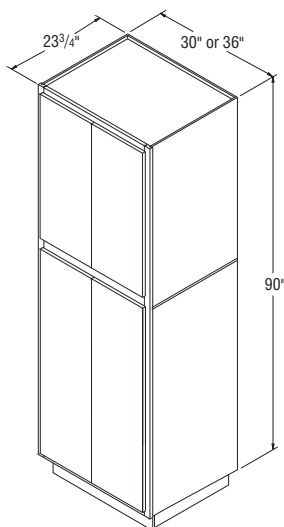

U3090B
U3690B

*Specify L or R on all single door Utility Cabinets.

NOTES ✓

- ▶ 96" high Utility cabinets include one fixed shelf between doors.
- ▶ Large openings on miter styles will be two doors doweled together.
- ▶ Shelves not included in Utility cabinets. For shelf and Roll Tray options see pages 165-166.
- ▶ All 96" Utility cabinets are shipped as a 92" cabinet with unfinished Loose Toekick Sub Assembly.
- ▶ Additional material may be needed to cover unfinished Loose Toekick Sub Assembly.
- ▶ Refer to the Cabinet Specifications Section for door opening dimensions.
- ▶ Refer to Loose Toekick Sub Assembly instructions for cabinet installation.



Utility Cabinets, 96" High, 12" and 23 3/4" Deep

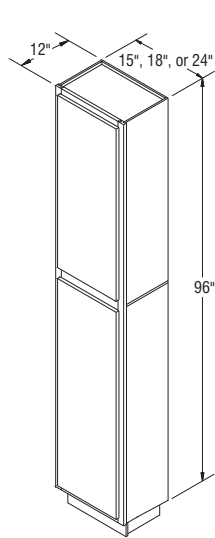

U159612*
U189612*
U249612*

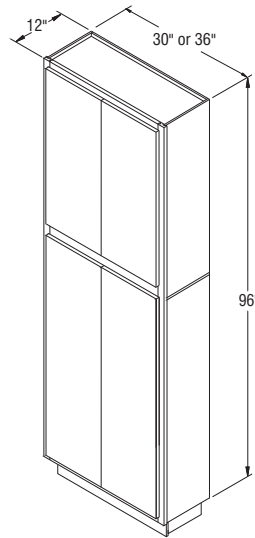

U309612B
U369612B

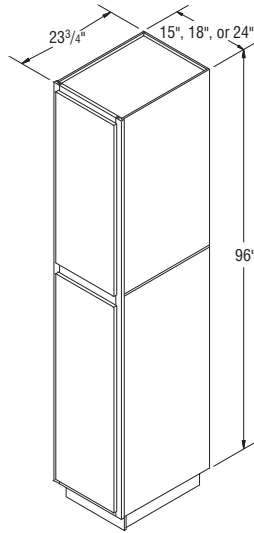

U1596*
U1896*
U2496*

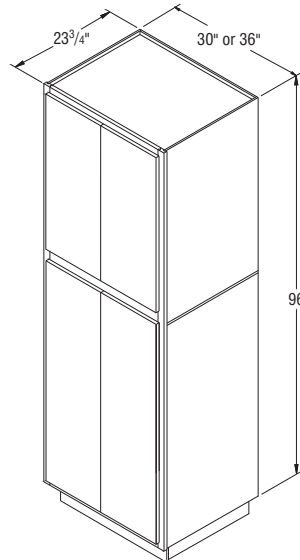

U3096B
U3696B

*Specify L or R on all single door Utility Cabinets.

Bookcases, 52 1/2" High, 12" Deep

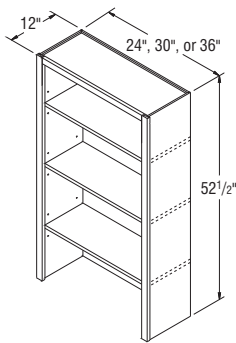

BK2452.5
BK3052.5
BK3652.5

NOTES ✓

- ▶ Includes three 3/4" thick matching Aristex™ shelves.
- ▶ Matching Aristex™ interior.
- ▶ Designed to mount on the Bookcase Base cabinet with countertop.
- ▶ For loads on shelves over 60 lbs., Aristokraft recommends the use of the Bookshelf Kit on page 159.

Bookcases, 64 1/2" High, 12" Deep

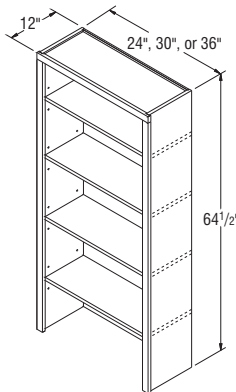

BK2464.5
BK3064.5
BK3664.5

NOTES ✓

- ▶ Includes four 3/4" thick matching Aristex™ shelves.
- ▶ Matching Aristex™ interior.
- ▶ Designed to mount on the Bookcase Base cabinet with countertop.
- ▶ For loads on shelves over 60 lbs., Aristokraft recommends the use of the Bookshelf Kit on page 159.

Bookcases, 84" High, 12" Deep

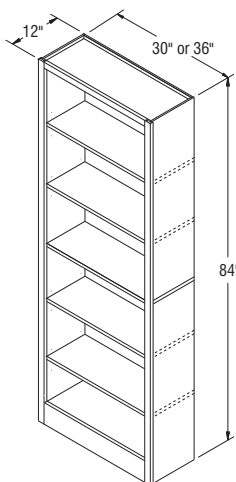

BK3084
BK3684

NOTES ✓

- ▶ Includes five 3/4" thick matching Aristex™ shelves — four adjustable and one fixed center shelf.
- ▶ Matching Aristex™ interior.
- ▶ Wide bottom rail.
- ▶ For loads on shelves over 60 lbs., Aristokraft recommends the use of the bookshelf Kit on page 159.

NOTES ✓

- ▶ Includes one 3/4" thick full-depth adjustable shelf.
- ▶ Matching Aristex™ interior.
- ▶ Does not include countertop.

Bookcase Bases, 30" High, 21" Deep

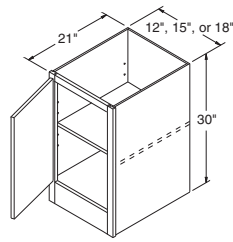

BKB1230
BKB1530
BKB1830

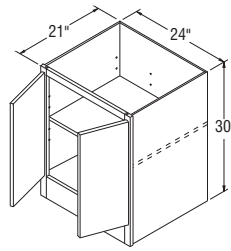

BKB2430

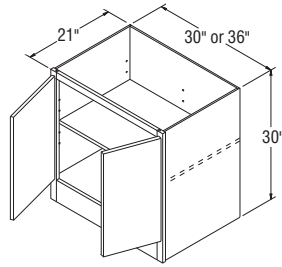

BKB3030B
BKB3630B

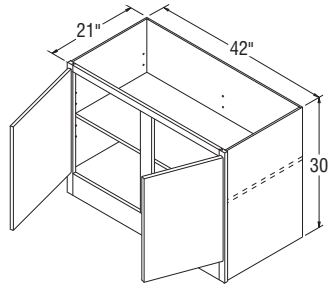

BKB4230

NOTES ✓

- ▶ Includes two full height drawers with Full Extension guides for all construction options.
- ▶ Includes hanging file system for folders, sent uninstalled.
- ▶ Includes wide bottom rail, no recessed Toekick.
- ▶ It is recommended that this unit be fastened to the wall when installing.
- ▶ Interior dimension for Standard Construction file drawer is 12³¹/₃₂" W x 19" D x 9⁵/₈" H.
- ▶ Interior dimension for Select and All Plywood Construction dovetail file drawer is 12⁵/₈" W x 16⁵/₈" D x 9¹/₄" H.
- ▶ Standard Construction accommodates front-to-back and side-to-side filing of letter documents and side-to-side filing of legal documents. Drawer width will not permit front-to-back filing of legal documents.
- ▶ Select and All Plywood Construction accommodates side-to-side filing of legal and letter documents.
- ▶ Drawer fronts will utilize raised panels on applicable styles.
- ▶ Smart Stop™ drawer guides are not available in Select and APC Construction.

Vanity File Drawer Base, 30" High, 18" Wide, 21" Deep

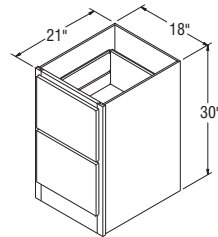

VFDB18

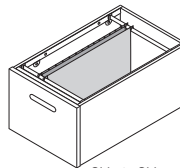

Side-to-Side Filing of Legal Documents

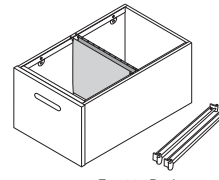

Front-to-Back Filing of Letter Documents

Standard Construction

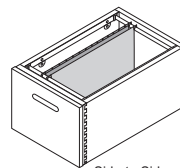

Side-to-Side Filing of Legal Documents

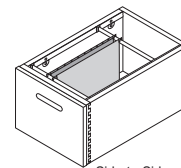

Side-to-Side Filing of Letter Documents

Select & APC



Vanity File Drawers, 30" High, 21" Deep

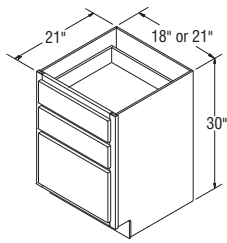

VFD18
VFD21

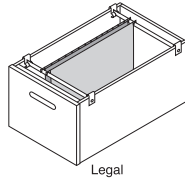

Legal

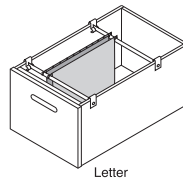

Letter

Standard/Select & APC

NOTES ✓

- ▶ The bottom drawer is deep for standard letter and legal documents and includes two adjustable hanging rods and four hanging clips.
- ▶ Bottom file drawer has $\frac{3}{4}$ extension guides.
- ▶ Interior dimension for standard file drawer is:
VFD18 – $12\frac{31}{32}$ " W x 19" D x $9\frac{5}{8}$ " H.
VFD21 – $15\frac{5}{32}$ " W x 19" D x $9\frac{5}{8}$ " H.
- ▶ Raised panel styles - drawer fronts will convert to raised panel;
Full Overlay - $10\frac{1}{4}$ " or higher
Partial Overlay - $9\frac{7}{8}$ " or higher



Kneespace Drawers, 4 $\frac{3}{4}$ " High, 21" Deep (Trimmable)

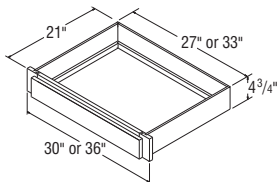

KDT30
KDT36

NOTES ✓

- ▶ Face frame trimmable 3" overall, $1\frac{1}{2}$ " on each side.
- ▶ Shallow depth drawer.
- ▶ Briarcliff II, Nantucket, and Wentworth have a slab drawer front.
- ▶ Not available in All Plywood Construction.
- ▶ 5-piece drawers not available.

NOTES ✓

- ▶ FP = False Panel.
- ▶ It may be necessary to modify the corner braces/stretcher rails with some sink applications.

Vanity Console Bases, 30" High, 21" Deep

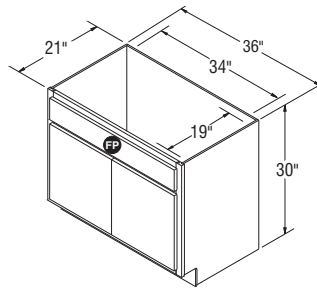

VCB36B

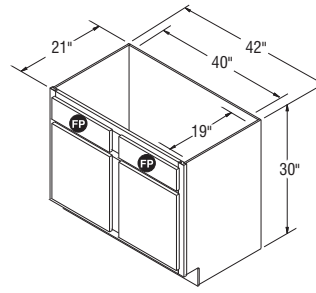

VCB42

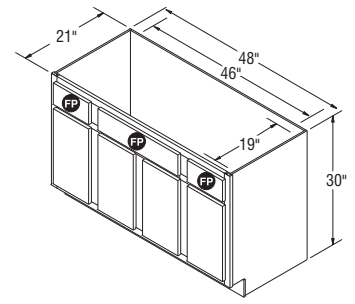

VCB48

NOTES ✓

- ▶ FP = False Panel.
- ▶ It may be necessary to modify the corner braces/stretcher rails with some sink applications.

Vanity Console Bases, 35" High, 21" Deep

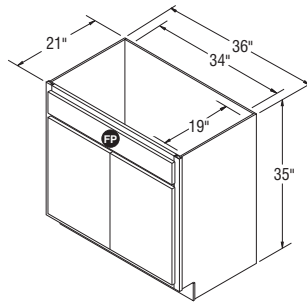

VCB3635B

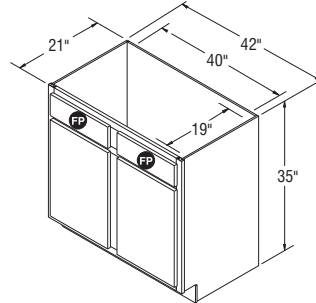

VCB4235

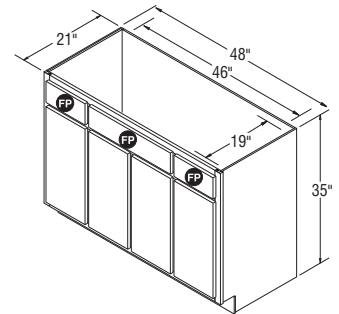

VCB4835

NOTES ✓

- ▶ Half-depth fixed shelf.
- ▶ 18" deep Vanities available in Standard construction only, with 5-Piece Drawer front option.

Vanity Bases, 30" High, 18" Deep

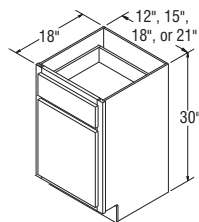

VB1218
VB1518
VB1818
VB2118

Vanity Bases, 30" High, 21" Deep

NOTES ✓

- ▶ Half-depth fixed shelf.
- ▶ VB24 has butt doors on all door styles.

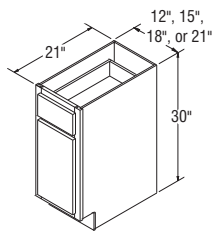

VB12
VB15
VB18
VB21

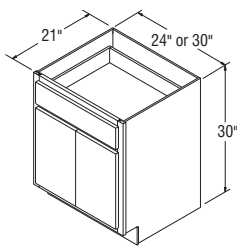

VB24
VB30B

Vanity Bases, 35" High, 21" Deep

NOTES ✓

- ▶ Half-depth fixed shelf.
- ▶ VB2435 has butt doors on all door styles.

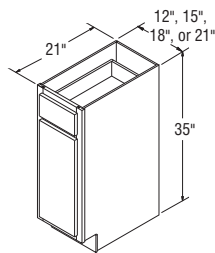

VB1235
VB1535
VB1835
VB2135

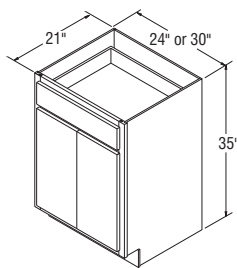

VB2435
VB3035B

Vanity Base Pull-Out, 35" High, 9" Wide, 21" Deep

NOTES ✓

- ▶ Features a wood Pull-Out unit with adjustable shelves, chrome rail sides, and Full Extension guides.
- ▶ Nantucket and Grayson VBP0935 cabinet doors utilize recessed center panels.
- ▶ Smart Stop™ is not available in Select and APC Construction.

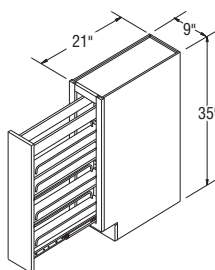

VBP0935



NOTES ✓

- ▶ FP = False Panel.
- ▶ It may be necessary to modify the corner braces/stretcher rails with some sink applications.
- ▶ 18" deep Vanities available in Standard construction only, with 5-Piece Drawer front option.
- ▶ Raised panel styles - drawer fronts will convert to raised panel;
Full Overlay - 10¹/₄" or higher
Partial Overlay - 9⁷/₈" or higher

Vanity Door and Drawer Bases, 30" High, 18" Deep

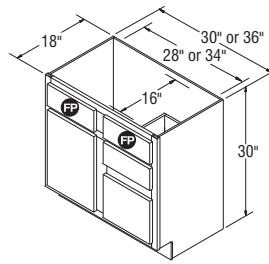
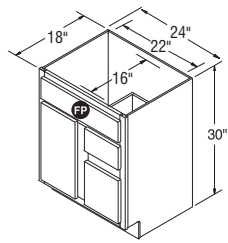

VDD2418*
VDD3018*
VDD3618*

*Specify L or R for which side to locate door.

NOTES ✓

- ▶ FP = False Panel.
- ▶ It may be necessary to modify the corner braces/stretcher rails with some sink applications.
- ▶ Raised panel styles - drawer fronts will convert to raised panel;
Full Overlay - 10¹/₄" or higher
Partial Overlay - 9⁷/₈" or higher

Vanity Door and Drawer Bases, 30" High, 21" Deep

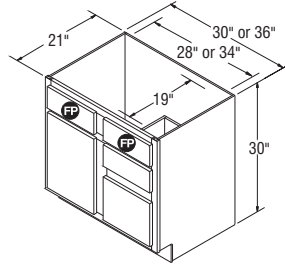
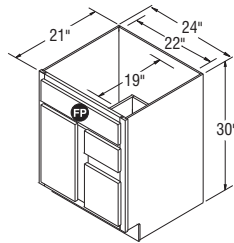

VDD24*

VDD30*
VDD36*

*Specify L or R for which side to locate door.

NOTES ✓

- ▶ FP = False Panel.
- ▶ It may be necessary to modify the corner braces/stretcher rails with some sink applications.
- ▶ Raised panel styles - drawer fronts will convert to raised panel;
Full Overlay - 10¹/₄" or higher
Partial Overlay - 9⁷/₈" or higher

Vanity Door and Drawer Bases, 35" High, 21" Deep

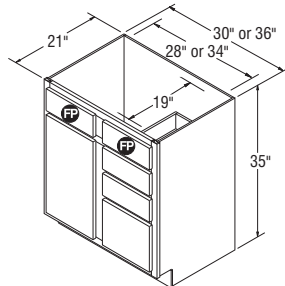
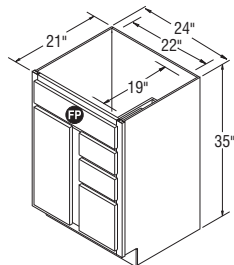

VDD2435*

VDD3035*
VDD3635*

*Specify L or R for which side to locate door.

Vanity Double Drawer Bases, 30" High, 18" Deep

NOTES ✓

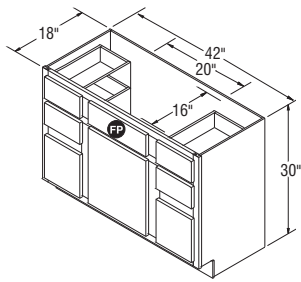

VDDB4218

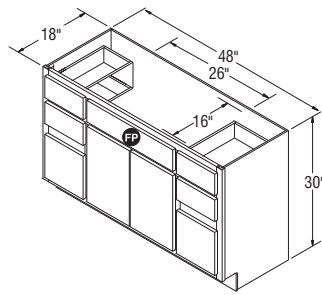

VDDB4818

- ▶ FP = False Panel.
- ▶ 18" deep Vanities available in Standard construction only, with 5-Piece Drawer front option.
- ▶ VDDB4818 has butt doors on all door styles.
- ▶ Raised panel styles - drawer fronts will convert to raised panel; Full Overlay - 10¼" or higher Partial Overlay - 9⅞" or higher

Vanity Double Drawer Bases, 30" High, 21" Deep

NOTES ✓

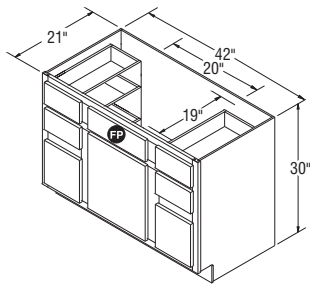

VDDB42

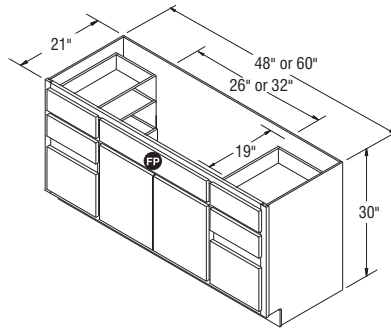

VDDB48
VDDB60

- ▶ FP = False Panel.
- ▶ VDDB48 and VDDB60 have butt doors on all door styles.
- ▶ Raised panel styles - drawer fronts will convert to raised panel; Full Overlay - 10¼" or higher Partial Overlay - 9⅞" or higher

Vanity Double Drawer Bases, 35" High, 21" Deep

NOTES ✓

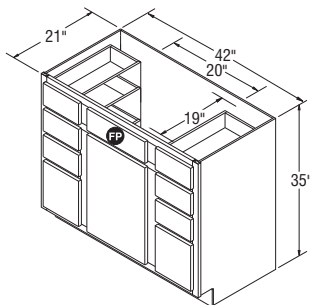

VDDB4235

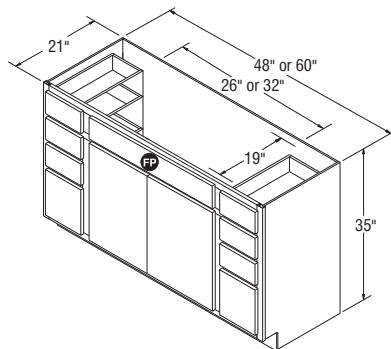

VDDB4835
VDDB6035

- ▶ FP = False Panel.
- ▶ VDDB4835 and VDDB6035 have butt doors on all door styles.
- ▶ Raised panel styles - drawer fronts will convert to raised panel; Full Overlay - 10¼" or higher Partial Overlay - 9⅞" or higher

NOTES ✓

- ▶ FP = False Panel.
- ▶ Cabinet is 57" wide.
- ▶ Front frame is 60" wide.
- ▶ Front end rails are each 3" and can be trimmed to 1½".
- ▶ VDDBT60 has butt doors on all door styles.
- ▶ Raised panel styles - drawer fronts will convert to raised panel;
Full Overlay - 10¼" or higher
Partial Overlay - 9⅞" or higher

Trimable Vanity Double Drawer Base, 30" High, 60" Wide, 21" Deep

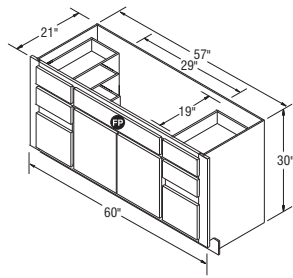

VDDBT60 *

*Not available in full overlay door styles.

NOTES ✓

- ▶ It may be necessary to modify the corner braces/stretcher rails with some sink applications.
- ▶ 16" wide and 14" deep space for sink opening.
- ▶ One full height door.
- ▶ 16" deep Vanities available in Standard Construction only.

Vanity Sink Base, 30" High, 18" Wide, 16" Deep

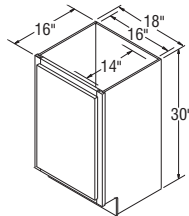

VSB1816

NOTES ✓

- ▶ FP = False Panel.
- ▶ It may be necessary to modify the corner braces/stretcher rails with some sink applications.
- ▶ VSB2418 has butt doors on all door styles.
- ▶ 18" deep Vanities available in Standard construction only.

Vanity Sink Bases, 30" High, 18" Deep

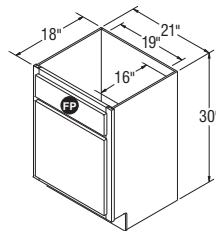

VSB2118

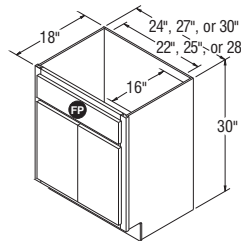

**VSB2418
VSB2718B
VSB3018B**

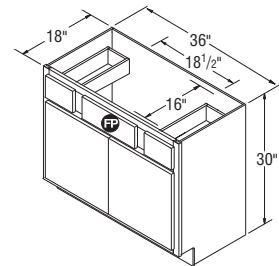

VSB3618B

Vanity Sink Bases, 30" High, 21" Deep

NOTES ✓

- ▶ FP = False Panel.
- ▶ It may be necessary to modify the corner braces/stretcher rails with some sink applications.
- ▶ VSB24 has butt doors on all door styles.

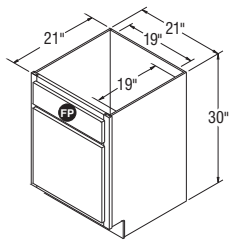

VSB21

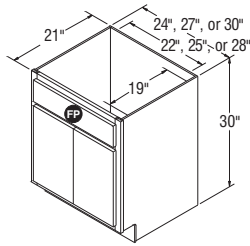

**VSB24
VSB27B
VSB30B
VSB33B**

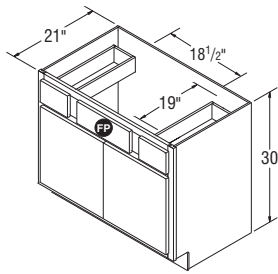

VSB36B

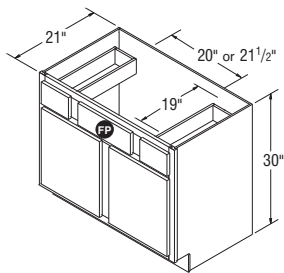

**VSB39
VSB42**

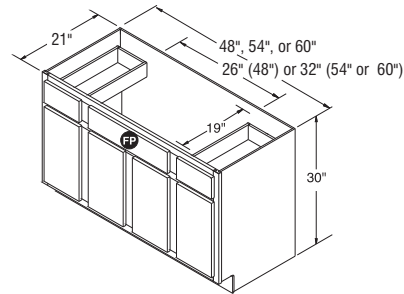

**VSB48
VSB54
VSB60**

Vanity Sink Bases, 32 1/2" High, 21" Deep

NOTES ✓

- ▶ FP = False Panel.
- ▶ Recommended for use in vanity designs for ADA compliance with a maximum installed height of 34".
- ▶ It may be necessary to modify the corner braces/stretcher rails with some sink applications.
- ▶ VSB2432.5 has butt doors on all door styles.

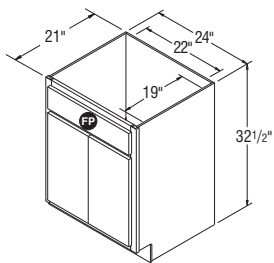

VSB2432.5

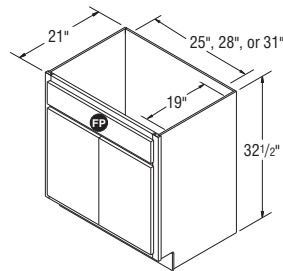

**VSB2732.5B
VSB3032.5B
VSB3332.5B**

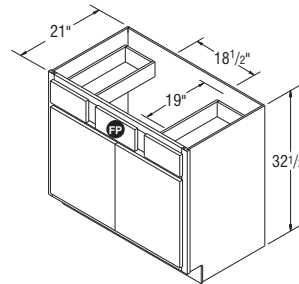

VSB3632.5B

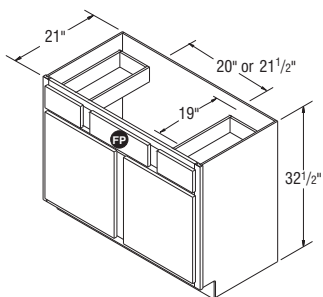

**VSB3932.5
VSB4232.5**

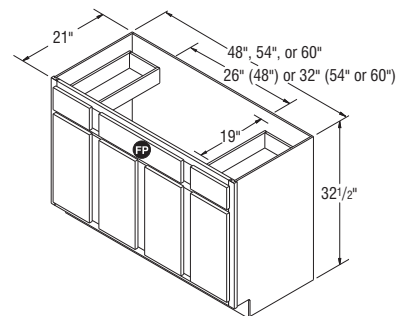

**VSB4832.5
VSB5432.5
VSB6032.5**

NOTES ✓

- ▶ FP = False Panel.
- ▶ It may be necessary to modify the corner braces/stretcher rails with some sink applications.
- ▶ VSB2435 has butt doors on all door styles.

Vanity Sink Bases, 35" High, 21" Deep

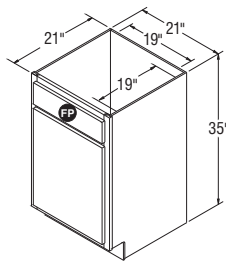

VSB2135

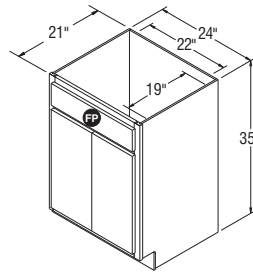

VSB2435

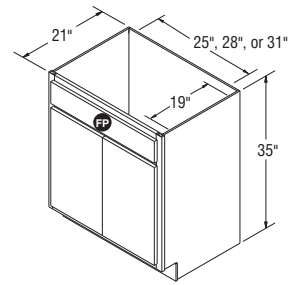

VSB2735B
VSB3035B
VSB3335B

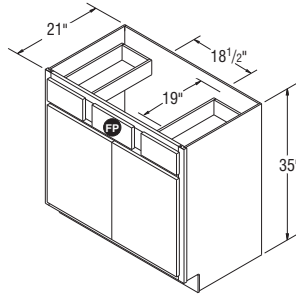

VSB3635B

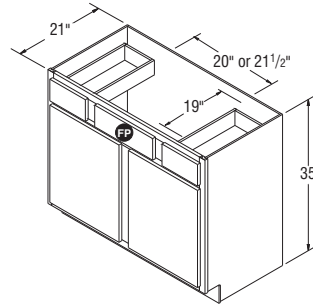

VSB3935
VSB4235

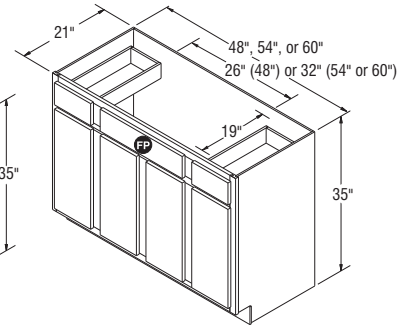

VSB4835
VSB5435
VSB6035

NOTES ✓

- ▶ Reversible Shelf will be constructed from 3/4" thick laminated furniture board. Shelf shipped secure, can be positioned in left or right corner.
- ▶ Both doors will have a chrome and wood two-tiered rack that is 3 3/8" deep.
- ▶ Includes two installed tip-out trays in false fronts.
- ▶ Quarter round shelf will be natural maple laminate for all styles, including White styles.
- ▶ Soft Close Hinges are not available in Select and APC Construction.



Vanity Sink Base SuperCabinets™ with Reversible Shelf, 35" High, 21" Deep

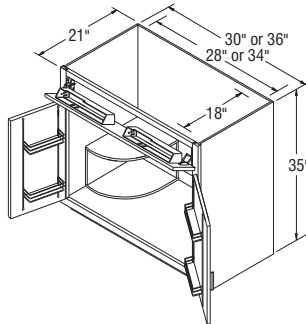

VSB3035STSB
VSB3635STSB

Vanity Sink Base SuperCabinets™, 35" High, 21" Deep

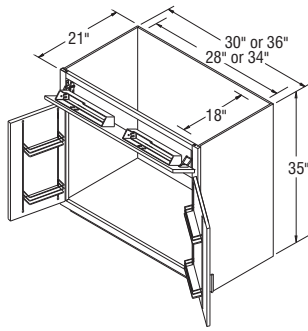

VSB3035STNSB
VSB3635STNSB

NOTES ✓

- ▶ Both doors will have a chrome and wood two-tiered rack that is 3¼" deep.
- ▶ Includes two installed tip-out trays.
- ▶ Soft Close Hinges are not available in Select and APC Construction.



Vanity Sink Drawer Base, 30" High, 60" Wide, 21" Deep

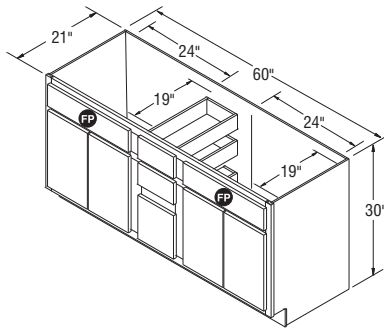

VSDB60

NOTES ✓

- ▶ FP = False Panel.
- ▶ Four doors (two butt each end), three center drawers, two false drawer fronts, 24" wide (each side) and 19" deep space for sink opening (each side).
- ▶ It may be necessary to modify the corner braces/stretcher rails with some sink applications.
- ▶ Raised panel styles - drawer fronts will convert to raised panel;
Full Overlay - 10¼" or higher
Partial Overlay - 9⅞" or higher

Vanity Sink Drawer Base, 35" High, 60" Wide, 21" Deep

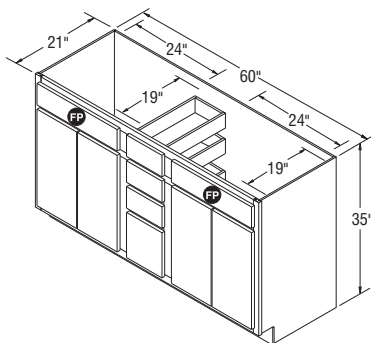

VSDB6035

NOTES ✓

- ▶ FP = False Panel.
- ▶ Four doors (two butt each end), four center drawers, two false drawer fronts, 24" wide (each side) and 19" deep space for sink opening (each side).
- ▶ It may be necessary to modify the corner braces/stretcher rails with some sink applications.
- ▶ Raised panel styles - drawer fronts will convert to raised panel;
Full Overlay - 10¼" or higher
Partial Overlay - 9⅞" or higher

NOTES ✓

- ▶ FP = False Panel.
- ▶ Four doors (two butt each end), three center drawers, two false drawer fronts, 18" wide (each side) and 19" deep space for sink opening (each side).
- ▶ Cabinet is 57" wide.
- ▶ Front frame is 60" wide.
- ▶ Front end rails are each 3" and can be trimmed 1/2" each.
- ▶ Raised panel styles - drawer fronts will convert to raised panel;
Full Overlay - 10 1/4" or higher
Partial Overlay - 9 7/8" or higher

Trimmable Vanity Sink Drawer Base, 30" High, 60" Wide, 21" Deep

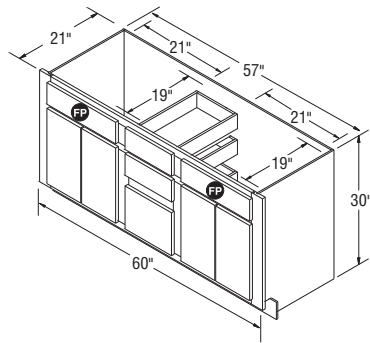

VSDBT60*

*Not available in full overlay door styles

NOTES ✓

- ▶ 18" deep Vanities available in Standard construction only, with 5-Piece Drawer front option.

Vanity Four Drawer Bases, 30" High, 18" Deep

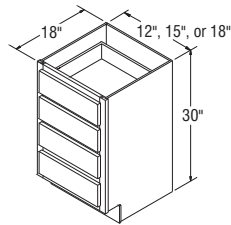

VDB1218-4
VDB1518-4
VDB1818-4

NOTES ✓

- ▶ 18" deep Vanities available in Standard construction only, with 5-Piece Drawer front option.
- ▶ Raised panel styles - drawer fronts will convert to raised panel;
Full Overlay - 10 1/4" or higher
Partial Overlay - 9 7/8" or higher
- ▶ The bottom drawer box is 6 3/8" high for Standard and 7 3/4" high for Select and APC.

Vanity Three Drawer Bases, 30" High, 18" Deep

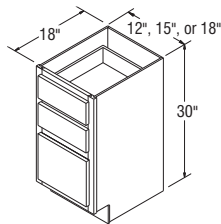

VDB1218
VDB1518
VDB1818

Vanity Four Drawer Bases, 30" High, 21" Deep

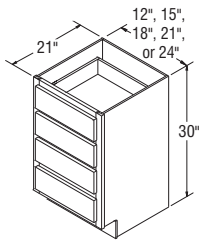

VDB12-4
VDB15-4
VDB18-4
VDB21-4
VDB24-4

Vanity Three Drawer Bases, 30" High, 21" Deep

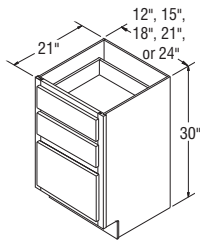

VDB12
VDB15
VDB18
VDB21
VDB24

NOTES ✓

- ▶ The bottom drawer box is 6³/₈" high for Standard and 7³/₄" high for Select and APC.
- ▶ Raised panel styles - drawer fronts will convert to raised panel;
 Full Overlay - 10¹/₄" or higher
 Partial Overlay - 9⁷/₈" or higher

Vanity Four Drawer Bases, 35" High, 21" Deep

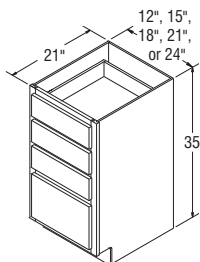

VDB1235-4
VDB1535-4
VDB1835-4
VDB2135-4
VDB2435-4

NOTES ✓

- ▶ Raised panel styles - drawer fronts will convert to raised panel;
 Full Overlay - 10¹/₄" or higher
 Partial Overlay - 9⁷/₈" or higher
- ▶ The bottom drawer box is 6³/₈" high for Standard and 7³/₄" high for Select and APC.

NOTES ✓

- ▶ The bottom drawer box is 6³/₈" high for Standard and 7³/₄" high for Select and APC.
- ▶ Raised panel styles - drawer fronts will convert to raised panel;
Full Overlay - 10¹/₄" or higher
Partial Overlay - 9⁷/₈" or higher

Vanity Three Drawer Bases, 35" High, 21" Deep

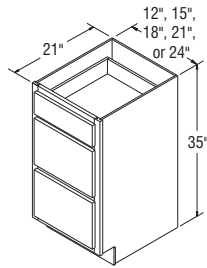

- VDB1235**
- VDB1535**
- VDB1835**
- VDB2135**
- VDB2435**

NOTES ✓

- ▶ Two adjustable 1/2" thick shelves.
- ▶ Must be surface mounted.
- ▶ Only available in Standard Construction.

Vanity Wall Cabinet, 30" High, 12" Wide, 5" Deep

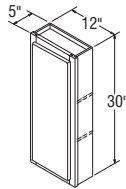

VWC12*

*Specify L or R on all Arch styles.
Doors will be Arch when ordering these styles.

NOTES ✓

- ▶ Must be recess mounted; exterior not finished.
- ▶ Cut out dimensions: 13³/₈" W x 18⁵/₈" H x 3³/₈" D
- ▶ Only available in Standard Construction.
- ▶ Includes fixed shelf.

Vanity Wall Cabinet, 20" High, 15" Wide, 4 1/8" Deep

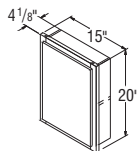

VWC1520*

*Specify L or R on all Arch styles.
Doors will be Arch when ordering these styles.

Vanity Tank Topper, 31" High, 24" Wide, 9" Deep

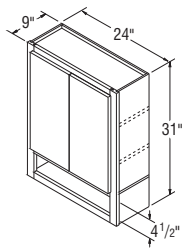

VTT24

NOTES ✓

- ▶ Interior color is the same as exterior color.
- ▶ Two butt doors, open shelf.
- ▶ Two adjustable 3/4" thick shelves.
- ▶ Not available on Briarcliff II Arch, or Eastland Arch.
- ▶ Includes plastic U-shaped hinge spacers for better door alignment.
- ▶ Soft Close Hinges are not available in Select and APC Construction.

Vanity Drawers Trimmable, 18" Deep (Trimmable 3")

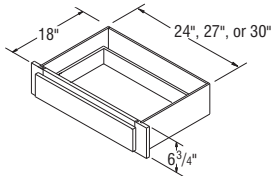

VDT2718
VDT3018
VDT3318

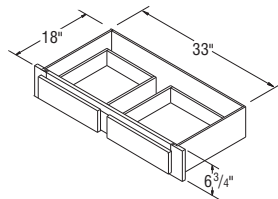

VDT3618

NOTES ✓

- ▶ Cabinets may not feature matching exterior laminate, so installation between two adjacent cabinets, walls, and/or panels is recommended.
- ▶ Face frame trimmable 3" overall, 1 1/2" on each side.
- ▶ 18" deep drawers available in Standard construction only; with 5-Piece Drawer Front option.

Vanity Drawers Trimmable, 21" Deep (Trimmable 3")

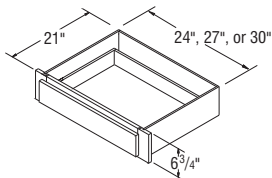

VDT27
VDT30
VDT33

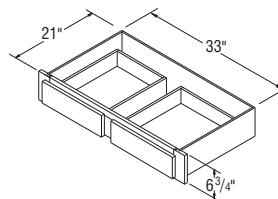

VDT36

NOTES ✓

- ▶ Cabinets may not feature matching exterior laminate, so installation between two adjacent cabinets, walls, and/or panels is recommended.
- ▶ Face frame trimmable 3" overall, 1 1/2" on each side.
- ▶ Not available in All Plywood Construction.

NOTES ✓

- ▶ Two doors and one drawer.
- ▶ Top door will be an Arch in applicable styles.
- ▶ Upper doors cannot be cut for glass.
- ▶ Includes 3/4" thick adjustable shelves, two in top section, one in bottom section and one fixed shelf.
- ▶ Drawer front height aligns with 35" Vanity/Base cabinet drawer fronts.
- ▶ Large openings on miter door styles will be two doors doweled together.
- ▶ 18" deep Vanities available in Standard construction only, with 5-Piece Drawer front option.
- ▶ TKIT not available.



Linen Closets with Drawer, 84" High, 18" Deep

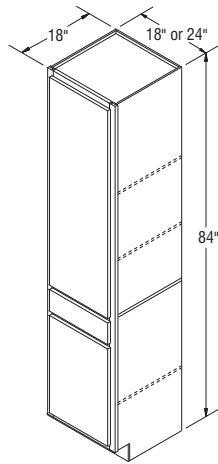

LCD1818*
LCD2418*

*Specify L or R on all styles.

NOTES ✓

- ▶ Two doors and one drawer.
- ▶ Top door will be an Arch in applicable styles.
- ▶ Includes 3/4" thick adjustable shelves, two in top section, one in bottom section and one fixed shelf.
- ▶ Drawer front height aligns with 35" Vanity/Base cabinet drawer fronts.
- ▶ Large openings on miter door styles will be two doors doweled together.



Linen Closets with Drawer, 84" High, 21" Deep

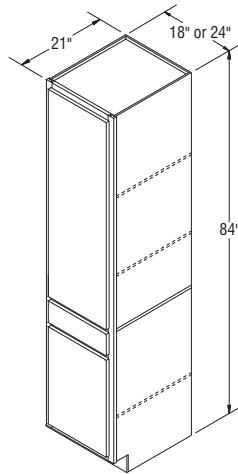

LCD18*
LCD24*

*Specify L or R on all styles.

Linen Closets SuperCabinet™ with Removable Hamper, 84" High, 21" Deep

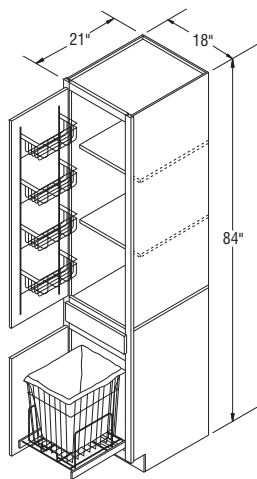

LCD18SC*

*Specify L or R on all styles.

NOTES ✓

- ▶ Two doors and one drawer.
- ▶ Top door will be an Arch in applicable styles.
- ▶ Includes two $\frac{3}{4}$ " thick adjustable shelves and 5" deep chrome door rack.
- ▶ Drawer front height aligns with standard 35" Base cabinet drawer front.
- ▶ Large openings on miter door styles will be two doors doweled together.
- ▶ Includes Full Extension removable chrome Pull-Out Hamper with removable cloth liner.
- ▶ Includes Full Extension non Smart Stop™ removable chrome Pull-Out Hamper with removable cloth liner.



Vanity Medicine Cabinet, 24" High, 17" Wide, 4 3/8" Deep

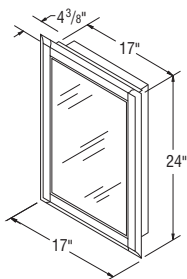

VMC1724

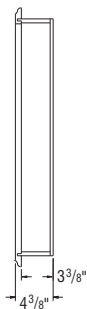

SIDE VIEW

NOTES ✓

- ▶ Interior of cabinet is white for all styles.
- ▶ One mirrored door with solid wood frame.
- ▶ Can be surface or recess mounted (recess mount recommended for all finishes other than white).
- ▶ Box made of white formed plastic
- ▶ Includes two adjustable shelves and one adjustable toothbrush shelf (plastic).
- ▶ Cabinet is reversible.
- ▶ Cut out for recess:
- ▶ Not available in Cherry or Hickory.
- ▶ Soft Close Hinges are not available in Select and APC Construction.



Vanity Tri-View Medicine Cabinet, 32" High, 4" Deep

NOTES ✓

- ▶ Three mirrored doors.
- ▶ Solid wood face frame.
- ▶ Can be surface or recess mounted.
- ▶ Chrome touch latches and hinges are used on doors.
- ▶ Box exterior matches face frame.
- ▶ Three fixed shelves.
- ▶ Cut out for recess:
 - VTMC2432 – 21⁵/₈" W x 3¹⁵/₁₆" D x 29³/₈" H.
 - VTMC3032 – 27⁵/₈" W x 3¹⁵/₁₆" D x 29³/₈" H.
 - VTMC3632 – 33⁵/₈" W x 3¹⁵/₁₆" D x 29³/₈" H.
 - VTMC4832 – 45⁵/₈" W x 3¹⁵/₁₆" D x 29³/₈" H.
- ▶ Soft Close Hinges are not available in Select and APC Construction.

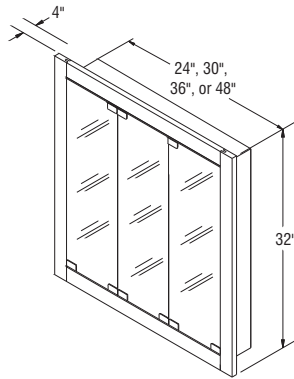

- VTMC2432**
- VTMC3032**
- VTMC3632**
- VTMC4832**



Linen Closet Shelf Kits

NOTES ✓

- ▶ Four shelves with clips.
- ▶ Shelves can be trimmed in the field to accommodate 18" deep linen closets.
- ▶ Natural maple laminate or specify LKS_ _WH to match white interiors.
- ▶ Order under style #010.
- ▶ Dimensions:
 - LKS18/LKS18WH – 1/2" T x 16 1/2" W x 20 3/16 D
 - LKS24/LKS24WH – 1/2" T x 22 1/2" W x 20 3/16" D

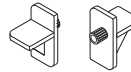
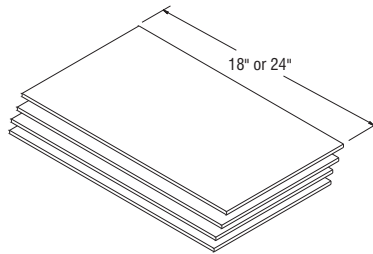

- LKS18C**
- LKS18CWH**
- LKS24C**
- LKS24CWH**



Universal Design Notes

32½" high cabinets are designed to comply with ADA (Americans with Disabilities Act) requirements of a 34" high overall counter height, including a 1½" countertop.

Available in the following styles:

- ▶ Avalon Maple
- ▶ Benton Birch
- ▶ Landen Maple
- ▶ Oakland Oak
- ▶ Saybrooke Birch
- ▶ Sinclair Birch
- ▶ Westbury Oak

Base Cabinets, 32 ½" High

NOTES ✓

- ▶ Includes one ¾" full depth adjustable shelf.

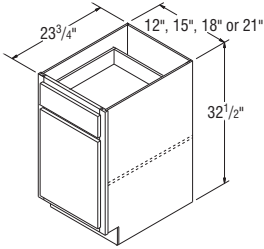

B1232.5
B1532.5
B1832.5
B2132.5

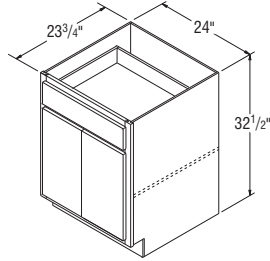

B2432.5DD

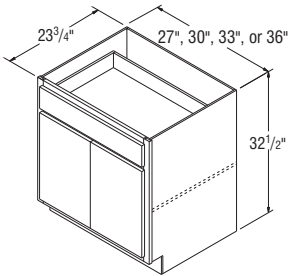

B2732.5B
B3032.5B
B3332.5B
B3632.5B

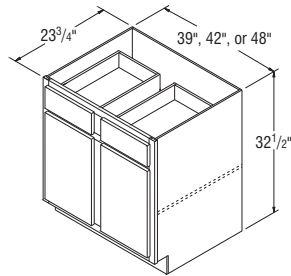

B3932.5
B4232.5
B4832.5

Base Cabinets with Full Height Doors, 32 ½" High

NOTES ✓

- ▶ Includes one ¾" full depth adjustable shelf.

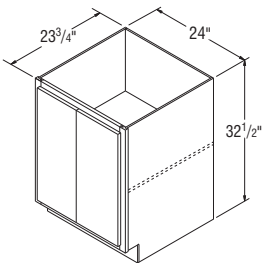

B2432.5DDFH

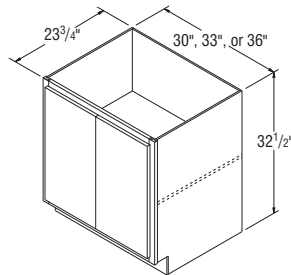

B3032.5FHB
B3332.5FHB
B3632.5FHB

Sink Base Cabinets, 32 1/2" High

NOTES ✓

- ▶ FP = False Panel.
- ▶ It may be necessary to modify the corner braces with some sink applications.
- ▶ Shelves not included.

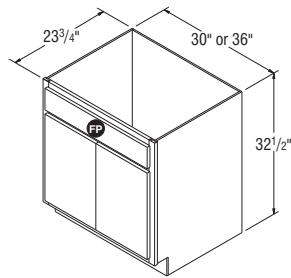

SB3032.5B
SB3632.5B

Sink Fronts, 32 1/2" High

NOTES ✓

- ▶ FP = False Panel.
- ▶ Sink Base Floor included with all units.
- ▶ Trimmable 3" each side.

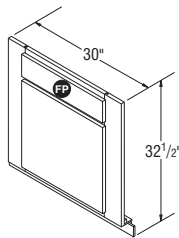

SF3032.5

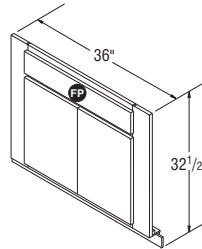

SF3632.5B

Sink Unit Cabinets with Front Panel, 32 1/2" High

NOTES ✓

- ▶ 26" and 32" wide and 16 1/2" deep space for sink opening.
- ▶ Shipped unassembled.
- ▶ Removable front panel.
- ▶ Do not use or install as a freestanding unit.
- ▶ It may be necessary to modify the corner braces with some sink applications.
- ▶ Not available in All Plywood Construction.

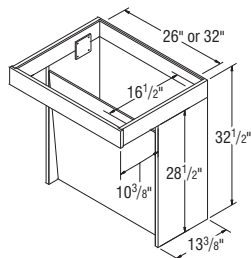

SU3032.5
SU3632.5

Three Drawer Base Cabinets, 32 1/2" High

NOTES ✓

- ▶ Available in selected door styles.

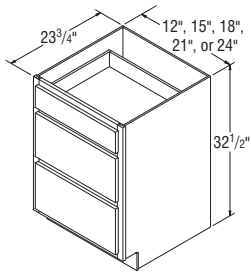

DB1232.5
DB1532.5
DB1832.5
DB2132.5
DB2432.5

Square Corner Roto Base Cabinet, 32 1/2" High

NOTES ✓

- ▶ Two rotating 27" diameter white shelves with a 60 lb. load capacity per shelf.
- ▶ One rotating door.
- ▶ Nominal gap of 1/4" on all sides of door.
- ▶ APC charges do not apply to SCR cabinets.
- ▶ Soft Close Hinges are not available in Select and APC Construction.

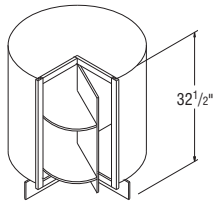

SCR3632.5

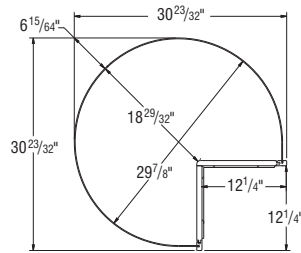

TOP VIEW



Base Lazy Susan Cabinet, 32 1/2" High

NOTES ✓

- ▶ One knuckle hinge door.
- ▶ Includes magnetic catch.
- ▶ Two 27" diameter rotating plastic white shelves that hold 60 lbs. per shelf.
- ▶ APC charges do not apply to BLS cabinets.
- ▶ Soft Close Hinges are not available in Select and APC Construction.

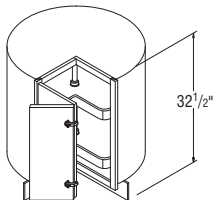

BLS3632.5

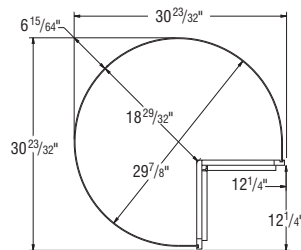

TOP VIEW



Universal Base Corner Cabinet Information

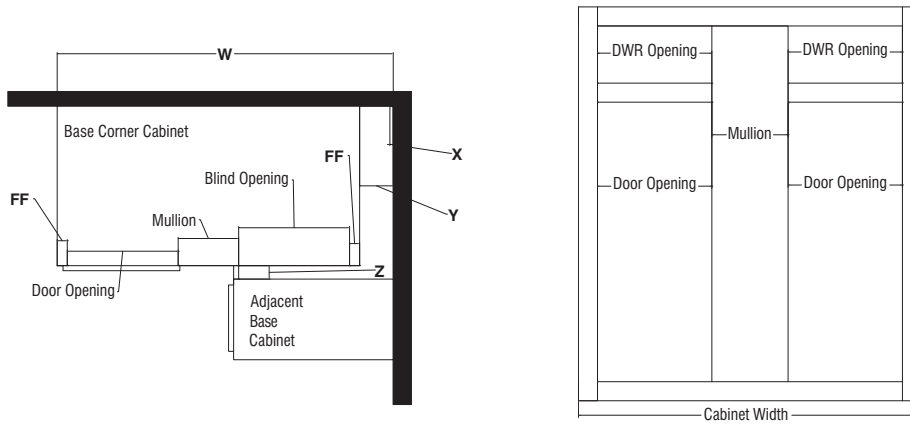

Full Overlay Universal Base Corner Cabinet Information

Full Overlay Styles	Actual Cabinet Width	X		Y	Z		W	
		Min. Pull	Min. Pull w/Hardware	Max. Pull	Min. Filler Required	Min. Filler Required w/Hardware	Min. Pull From Wall To End of Cabinet	Max Pull From Wall To End of Cabinet
BC3632.5	27"	9 ³ / ₄ "	11 ¹ / ₄ "	12 ¹ / ₂ "	1"	2 ¹ / ₂ "	36 ³ / ₄ "	39 ¹ / ₂ "
BC3932.5	30"	6 ³ / ₄ "	8 ¹ / ₄ "	12 ¹ / ₂ "	1"	2 ¹ / ₂ "	36 ³ / ₄ "	42 ¹ / ₂ "
BC4232.5	36"	3 ³ / ₄ "	5 ¹ / ₄ "	9 ¹ / ₂ "	1"	2 ¹ / ₂ "	39 ³ / ₄ "	45 ¹ / ₂ "
BC4532.5	42"	³ / ₄ "	2 ¹ / ₄ "	6 ¹ / ₂ "	1"	2 ¹ / ₂ "	42 ³ / ₄ "	48 ¹ / ₂ "
BC4832.5	45"	0"	³ / ₄ "	5"	1"	2 ¹ / ₂ "	45"	50"

7/16" Overlay Universal Base Corner Cabinet Information

7/16" Overlay Styles	Actual Cabinet Width	X		Y	Z		W	
		Min. Pull	Min. Pull w/Hardware	Max. Pull	Min. Filler Required	Min. Filler Required w/Hardware	Min. Pull From Wall To End of Cabinet	Max Pull From Wall To End of Cabinet
BC3632.5	27"	9 ³ / ₄ "	10 ³ / ₄ "	12 ¹ / ₂ "	¹ / ₂ "	2"	36 ³ / ₄ "	39 ¹ / ₂ "
BC3932.5	30"	6 ¹ / ₄ "	7 ³ / ₄ "	12 ¹ / ₂ "	¹ / ₂ "	2"	36 ¹ / ₄ "	42 ¹ / ₂ "
BC4232.5	36"	3 ³ / ₄ "	4 ³ / ₄ "	9 ¹ / ₂ "	¹ / ₂ "	2"	39 ³ / ₄ "	45 ¹ / ₂ "
BC4532.5	42"	¹ / ₄ "	1 ³ / ₄ "	6 ¹ / ₂ "	¹ / ₂ "	2"	42 ¹ / ₄ "	48 ¹ / ₂ "
BC4832.5	45"	0"	¹ / ₄ "	5"	¹ / ₂ "	2"	45"	50"
BC4832.5	45"	0"	¹ / ₄ "	5"	¹ / ₂ "	2"	45"	50"

Base Corner Cabinets, 32 1/2" High, 23 3/4" Deep

NOTES ✓

- ▶ All Base Corner Cabinets are reversible from left blind to right blind.
- ▶ 3" filler is included with all Base Corner Cabinets and shipped unattached.
- ▶ To ensure proper door/drawer clearance we recommend you do not install appliances next to the blind.
- ▶ Adjoining run of cabinets will cover blind opening.
- ▶ One door and one drawer installed on each Base Corner Cabinet.
- ▶ Base Corner Cabinets are designed to use same amount of wall space designated in the SKU nomenclature, and may be pulled up to maximum amount on chart to accommodate odd dimensions in a kitchen.
- ▶ For minimum and maximum pull dimensions, refer to allowable minimum and maximum pull dimensions provided.

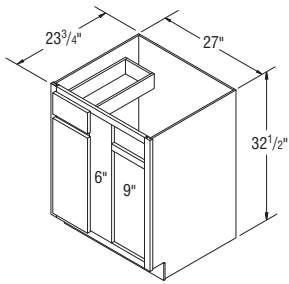

BC3632.5

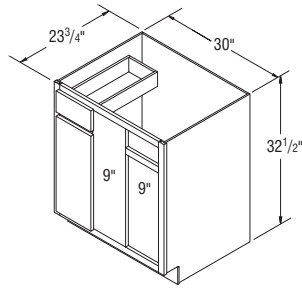

BC3932.5

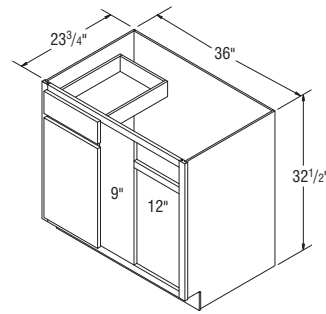

BC4232.5

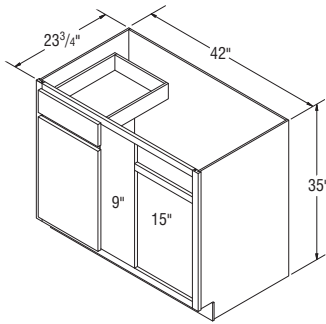

BC4532.5

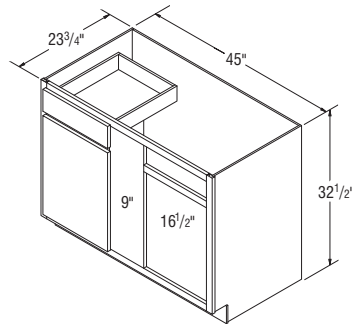

BC4832.5

Built-In Microwave Cabinet, 32 1/2" High

NOTES ✓

- ▶ Microwave opening is trimmable.
- ▶ Designed for Built-in Microwaves with trim kits (Cabinet has standard Aristex™ natural maple interior).

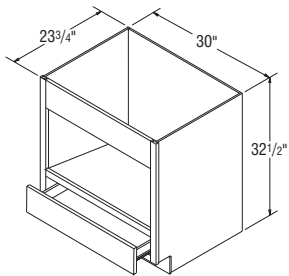

BMW3032.5

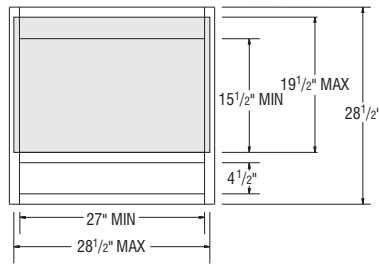

TRIM AREA

NOTES ✓

- ▶ Recommended installation height of 32½" to allow sufficient toe clearance for Universal Design stand-alone vanity applications as a wall hanging unit.
- ▶ Sink Opening Dimensions:
 Depth: 16¾"
 Widths: VWS2923 = 24¾"
 VWS3223 = 27¾"
 VWS3523 = 30¾"
 VWS4123 = 36¾"
- ▶ Not available in All Plywood Construction.

Vanity Wall Sink Cabinets, 23" High

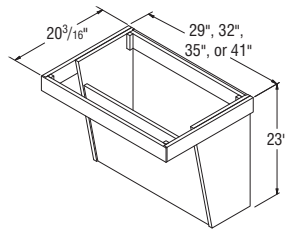

- VWS2923**
- VWS3223**
- VWS3523**
- VWS4123**

NOTES ✓

- ▶ Must be ordered with Vanity Wall Sink Cabinet (VWS). Not designed to be a stand-alone unit.
- ▶ Two plywood mending plates included to mount RVWS to VWS.
- ▶ Able to be removed for handicap accessible use.

Removable Vanity Wall Sink Cabinets, 32 1/2" High, 21" Deep

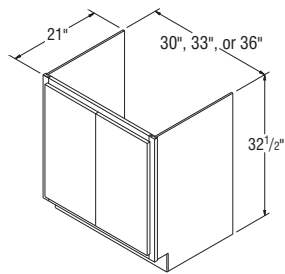

- RVWS3032B**
- RVWS3332B**
- RVWS3632B**

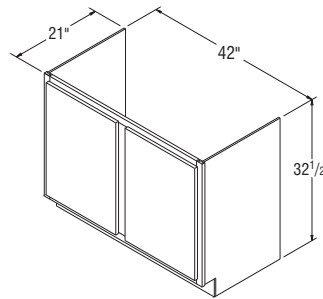

- RVWS4232**

Scribe Moulding

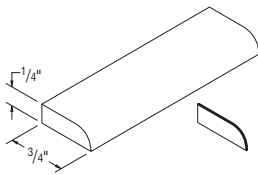

MSW8
PSMSW8 *New*

Outside Corner Moulding – 90° and 135°

DESIGN SOLUTIONS

- Use to create a finished look on ends of cabinet runs.

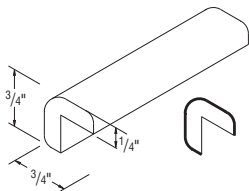

MOCW8

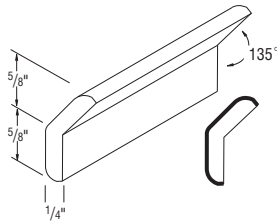

MOC135-8

Triple Bead Moulding

DESIGN SOLUTIONS

- Can be used with Inset Crown Moulding.

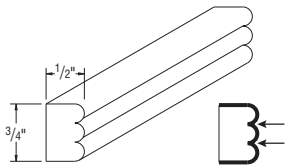

MTBEAD8
PSMTBEAD8 *New*

Trim Moulding *New*

DESIGN SOLUTIONS

- Can be used to hide seams in stacked cabinet applications.

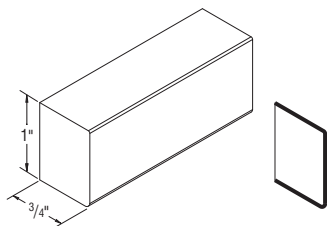

MTW8
PSMTW8

Finished edges indicated by bold lines on side view drawings.
Glazed edges indicated by arrows on side view drawings.

NOTES ✓

► MSHKRCROWN8 available in maple finishes only.

DESIGN SOLUTIONS

- For Moulding Solutions, see pages 38 & 39.
- Remember to order extra Mouldings when working with mitered corners.
- MICROWN8 and PSMICROWN8 are designed for inserts (i.e. dentil, rope, triple bead.)
- At minimum, leave a 3" reveal at the end of a run to allow Moulding and countertop ample clearance to return back to the wall.



Crown Moulding

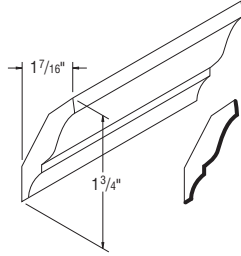

MCROWN8 (1 - 8' pc)
PSMICROWN8 (1 - 8' pc) *New*

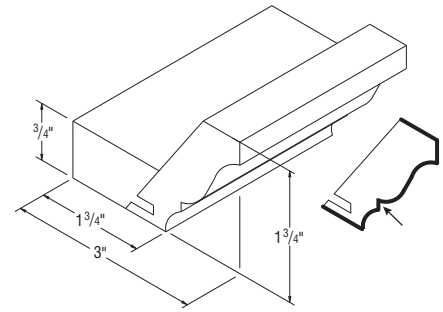

Full Overlay
MFOLCR8 (1 - 8' pc)
PSMFOLCR8 (1 - 8' pc) *New*

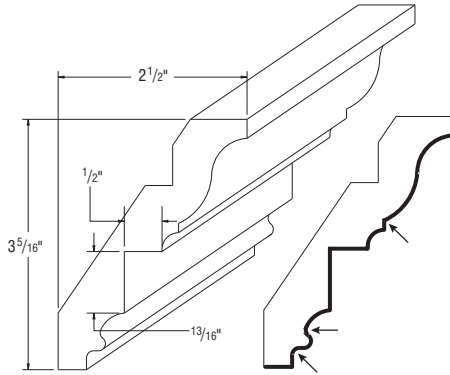

Insert
MICROWN8 (1 - 8' pc)
PSMICROWN8 (1 - 8' pc) *New*

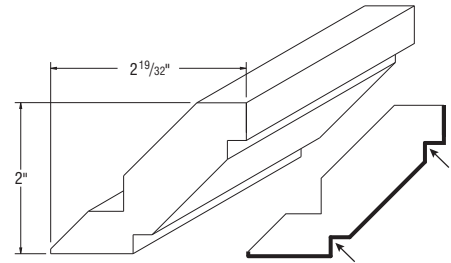

Shaker
MSHKRCROWN8 (1 - 8' pc)

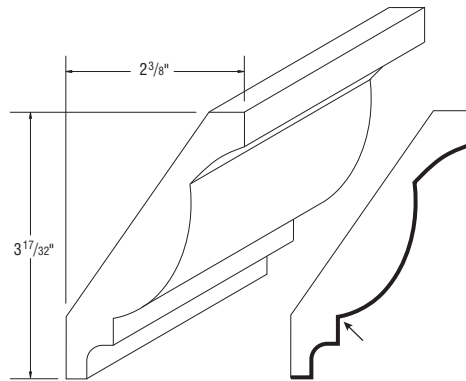

Tall
MTCROWN8 (1 - 8' pc)
PSMTROWN8 (1 - 8' pc) *New*

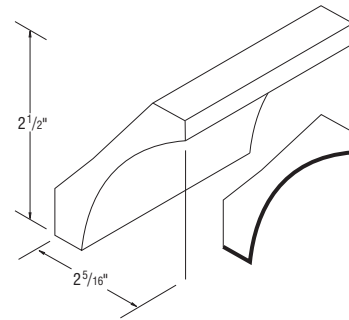

Small Cove
MSMCOVECR8 (1 - 8' pc)

Finished edges indicated by bold lines on side view drawings.
Glazed edges indicated by arrows on side view drawings.

Starter Moulding

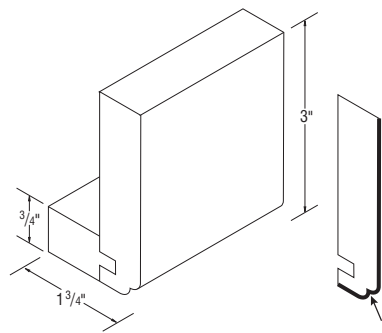

MSTR8 (1 - 8' pc)

NOTES ✓

- ▶ Top-mount installation only (cleat is attached).

DESIGN SOLUTIONS

- ▶ MSTR8 is for use with stacked moulding designs for ease of installation of top mouldings.



Soffit Filler Mouldings

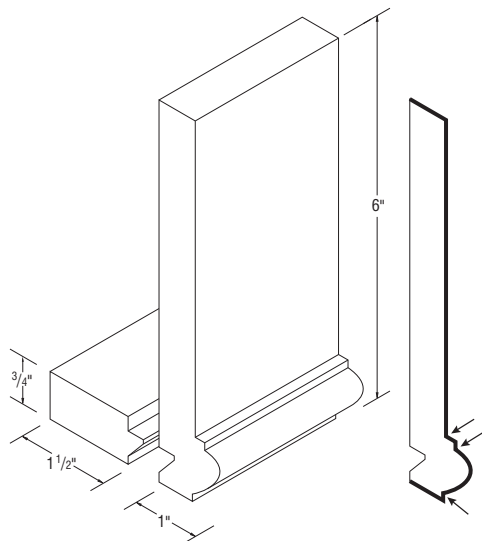

MSFM8 (1 - 8' pc)

NOTES ✓

- ▶ Cleat shipped unattached, can be MSFM8 (1 - 8' pc) top or face mounted.

DESIGN SOLUTIONS

- ▶ MSFM8 is for use with stacked moulding designs for ease of installation.



Counter Top Moulding

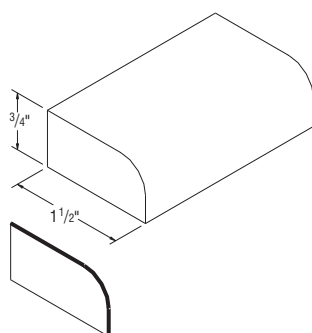

MCTR8 (1 - 8' pc)

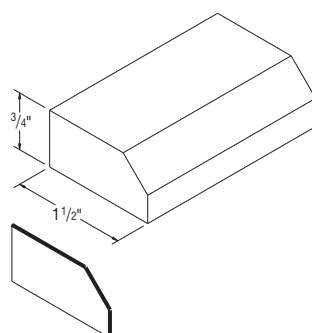

MCTB8 (1 - 8' pc)

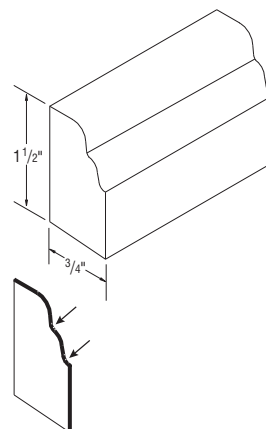

MCTOG8 (1 - 8' pc)

DESIGN SOLUTIONS

- ▶ MCTB8 can be flipped upside-down and used as top trim.



Finished edges indicated by bold lines on side view drawings.
Glazed edges indicated by arrows on side view drawings.



Cove Moulding

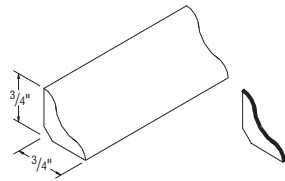

MCV8 (1 - 8' pc)



Quarter Round Moulding

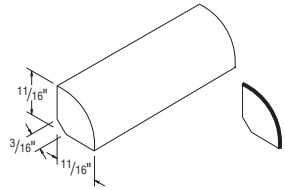

MQR8 (1 - 8' pc)
PSMQR8 (1 - 8' pc) *New*



Batten Moulding

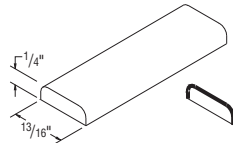

MBAT8 (1 - 8' pc)



Traditional Soffit Trim Moulding

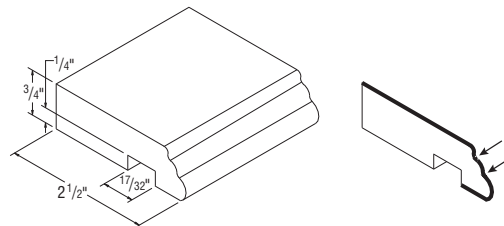

MTST8 (1 - 8' pc)
PSMTST8 (1 - 8' pc) *New*

Finished edges indicated by bold lines on side view drawings.
 Glazed edges indicated by arrows on side view drawings.

Traditional Cap Moulding

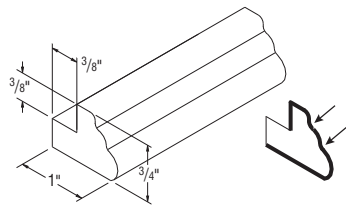

MTCAP8 (1 - 8' pc)
PSMTCAP8 (1 - 8' pc) *New*

DESIGN SOLUTIONS

- ▶ MTCAP8 and PSMTCAP8 can be flipped upside-down and used as a base piece for a stacked top trim.



Tall Light Rail Moulding

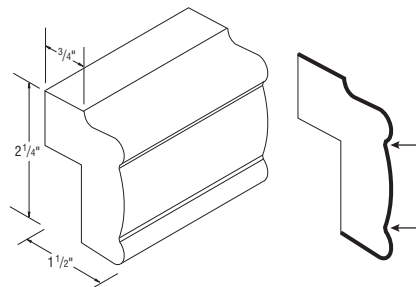

MTLR8 (1 - 8' pc)
PSMTLR8 (1 - 8' pc) *New*



Light Rail Moulding

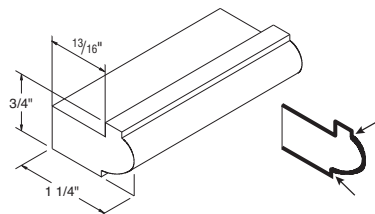

MLR8 (1 - 8' pc)

NOTES ✓

- ▶ Designed to mount under the face frame of Wall Cabinets.



Traditional Trim Moulding

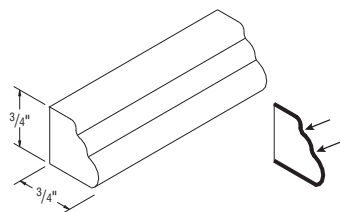

MTT8 (1 - 8' pc)



Finished edges indicated by bold lines on side view drawings.
 Glazed edges indicated by arrows on side view drawings.

DESIGN SOLUTIONS

▶ MTBAT8 can be used with Insert Crown Moulding.



Traditional Batten Moulding

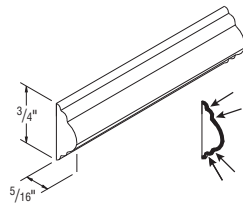

MTBAT8 (1 - 8' pc)

NOTES ✓

▶ MIDENTIL8 can be used with Insert Crown Moulding.



Dentil Moulding

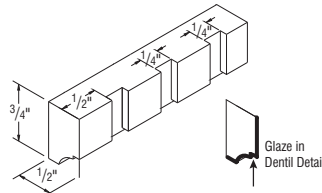

MIDENTIL8 (1 - 8' pc)

DESIGN SOLUTIONS

▶ MROPE8 can be used with Insert Crown Moulding.



Rope Moulding

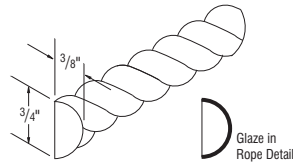

MROPE8 (1 - 8' pc)



Base Shoe Moulding

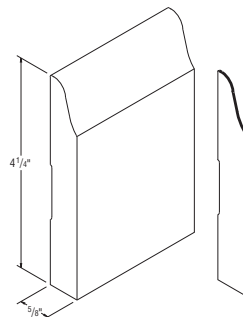

MBS8 (1 - 8' pc)

Finished edges indicated by bold lines on side view drawings.
Glazed edges indicated by arrows on side view drawings.

Fillers

NOTES ✓

- ▶ FBC3X3 Overlays available for Briarcliff II, Durham, Eastland, Nantucket, Overton, and Wentworth. Must order separately under OL3X3 code.
- ▶ All Fillers finished on front and two long edges, except for F531A45 and BLVDFF331 which are finished on both sides and both long edges.
- ▶ All Fillers are 3/4" thick.
- ▶ BLVDFF331 - 45° reversible angled filler (fluted one side). Comes as a pair. Reversible, finished on back.
- ▶ F531A45 - 45° reversible decorative angled filler (fluted one side). Comes as a pair. Trimmable 2" top and bottom. Reversible, finished on back.
- ▶ TKF3 - Toekick Filler. Order under style #010.
- ▶ F14X96 is 1/4" thick. Designed to fill space between adjacent cabinets. When ordered with Rustic Birch door styles, will not feature Rustic characteristics. Finished 1/4" on front and 3/4" all edges (backs are not finished).

MOULDINGS AND TRIM

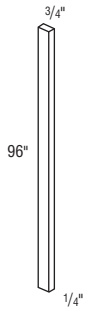

F14X96

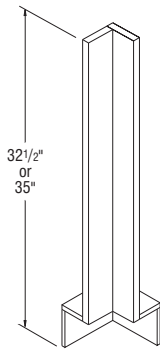

FBC3X332.5
FBC3X3

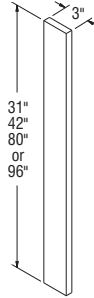

F331
F342
F380
F396

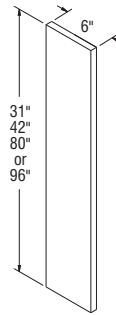

F631
F642
F680
F696

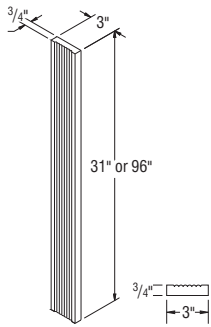

3" Reeded Fillers

FF331
FF396

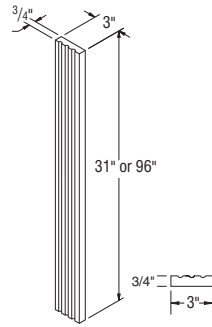

3" Fluted Fillers

FFL331
FFL396

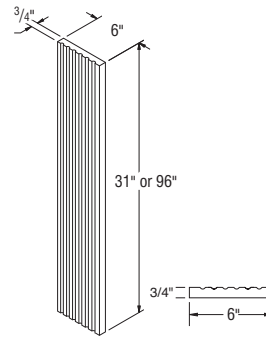

6" Fluted Fillers

FFL631
FFL696

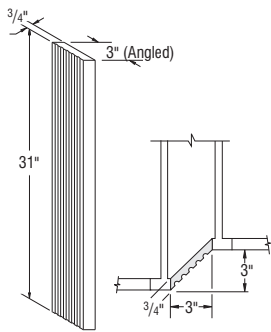

Angled Fluted/
Plain Filler

BLVDFF331

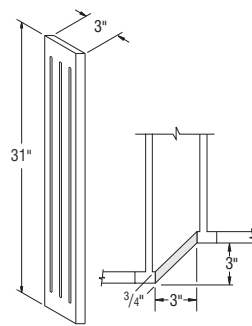

Decorative Angled Fluted/
Plain Filler

F531A45



TKF3*

*Order under style #010.

Overlays*

* Overlays are only available in Brellin, Briarcliff II, Durham, Eastland, Nantucket, Overton and Wentworth.

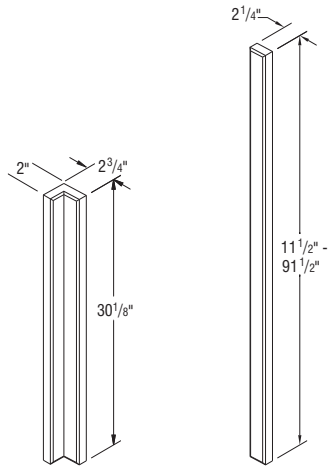

OL3X3

OL12

OL335

OL14

OL36

OL18

OL42

OL24

OL80

OL26

OL86

OL30

OL92

OL31

Model	Dimensions	Usage Details
OL3X3	2" x 30 ¹ / ₈ " & 2 ³ / ₄ " x 30 ¹ / ₈ "	FBC3X3 Base Corner Filler
OL12	2 ¹ / ₄ " x 11 ¹ / ₂ "	12" high Wall
OL14	2 ¹ / ₄ " x 13 ¹ / ₂ "	14" high Wall
OL18	2 ¹ / ₄ " x 17 ¹ / ₂ "	18" high Wall
OL24	2 ¹ / ₄ " x 23 ¹ / ₂ "	24" high Wall
OL26	2 ¹ / ₄ " x 25 ¹ / ₂ "	30" high Vanity
OL30	2 ¹ / ₄ " x 29 ¹ / ₂ "	30" high Wall
OL31	2 ¹ / ₄ " x 30 ¹ / ₈ "	35" high Base/Vanity
OL335	2 ¹ / ₄ " x 30 ¹ / ₈ "	PEPR335 Panels
OL36	2 ¹ / ₄ " x 35 ¹ / ₂ "	36" high Wall
OL42	2 ¹ / ₄ " x 41 ¹ / ₂ "	42" high Wall
OL80	2 ¹ / ₄ " x 79 ¹ / ₂ "	84" high Utility
OL86	2 ¹ / ₄ " x 85 ¹ / ₂ "	90" high Utility
OL92	2 ¹ / ₄ " x 91 ¹ / ₂ "	96" high Utility

Overlays*

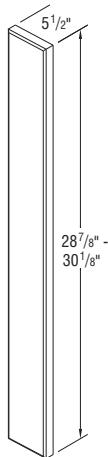

OL631

Model	Dimensions	Usage Details
OL631	Full Overlay Door Styles 5 ¹ / ₂ " x 30 ¹ / ₈ "	35" high Base/Vanity
	Partial Overlay Door Styles 5 ¹ / ₂ " x 28 ⁷ / ₈ "	35" high Base/Vanity

Split Turnings

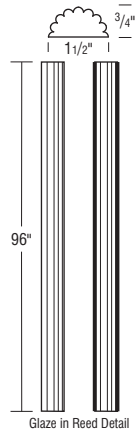

REED96
(each)

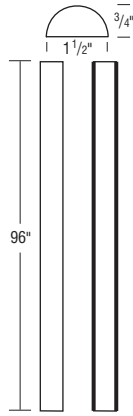

SPOOL96
(each)

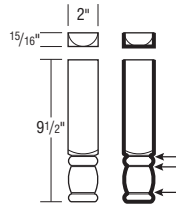

SPTRINGEND
(pair)

NOTES ✓

- ▶ SPTRINGEND is sold in pairs and are trimmable up to 5" each.



Rosette

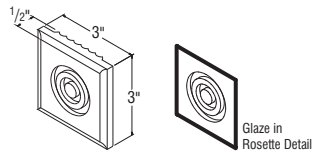

FFROS3X3

NOTES ✓

- ▶ Grooved to fit FFs.



Acanthus Overlay

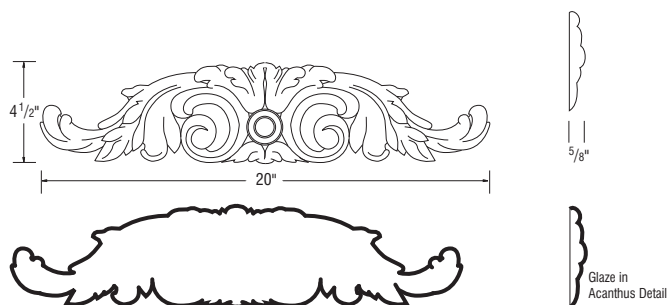

ACOVLY

NOTES ✓

- ▶ Can be added to all Wood Hoods, except Canopy Wood Hood Arch (WHCA), for decorative embellishment. (See page 66).



Finished edges indicated by bold lines on side view drawings.
Glazed edges indicated by arrows on side view drawings.

NOTES ✓

- ▶ Finished on all sides (reversible).
- ▶ Not intended to be used as a freestanding shelf support.
- ▶ VCORBEL sold in pairs.
- ▶ VCORBEL is 3/4" thick.
- ▶ VCORBEL11 has a 3" wide back plate.



Valance Corbels, 4" & 9 1/4" High

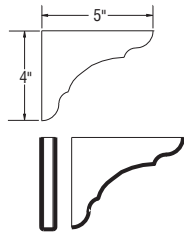

VCORBEL
(pair)

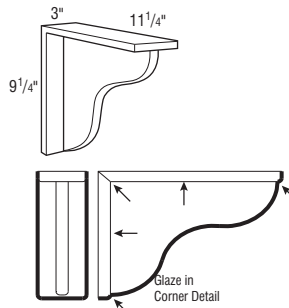

VCORBEL11

NOTES ✓

- ▶ In order to support substantial weight, Corbels must be properly installed with the attachment screws driven into a stud wall.



Art Corbel, 9" High

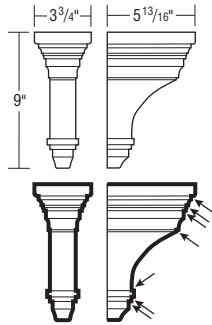

CORBELART9

NOTES ✓

- ▶ In order to support substantial weight, Corbels must be properly installed with the attachment screws driven into a stud wall.



Mission Corbels, 6" & 9" High

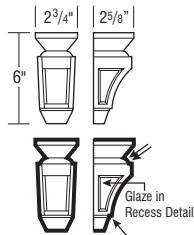

CORBELMIS6

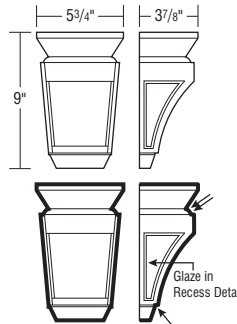

CORBELMIS9

Finished edges indicated by bold lines on side view drawings.
Glazed edges indicated by arrows on side view drawings.

Corbels, 9" & 13" High

DESIGN SOLUTIONS

► In order to support substantial weight, Corbels must be properly installed with the attachment screws driven into a stud wall.

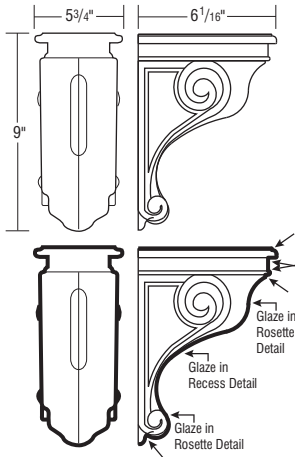

SMCORBEL

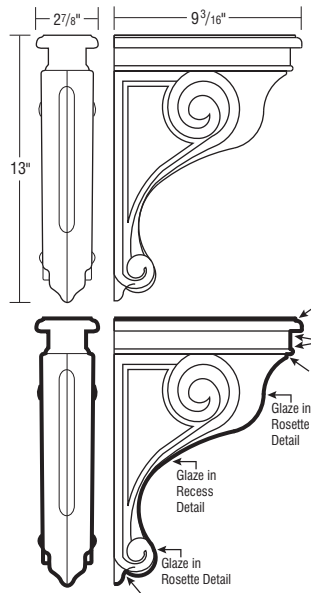

LGCORBEL

Decorative Feet

NOTES ✓

► Trimmable.

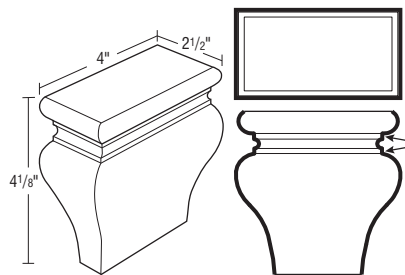

TKTLFOOT

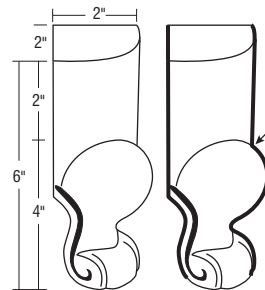

FRNLEG

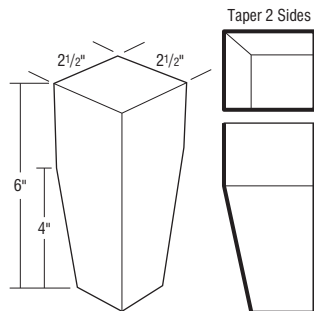

TAPLEG



Decorative Legs

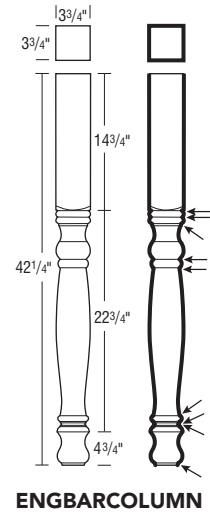
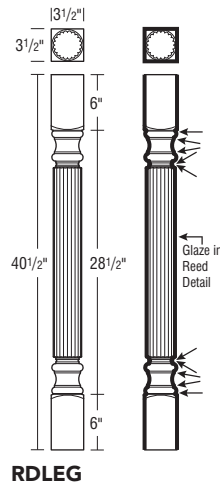
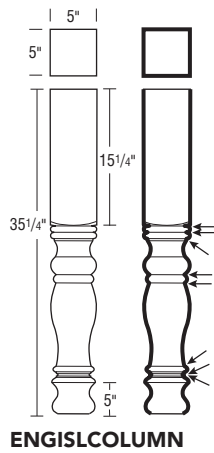
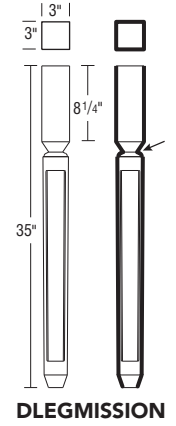
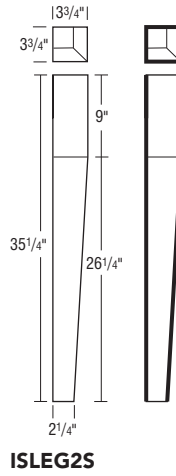
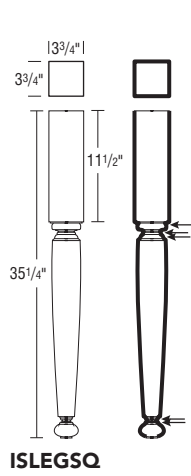

Finished edges indicated by bold lines on side view drawings.
Glazed edges indicated by arrows on side view drawings.

Valances Scalloped, 4 9/16" High

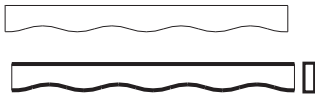

V549SC

Model	Length
V549SC	49"

DESIGN SOLUTIONS

- ▶ 3/4" thick.
- ▶ Trimmable up to 1/2" on each side: 1" overall.
- ▶ Valances not finished on back or ends.



Valances Arch, 5" High

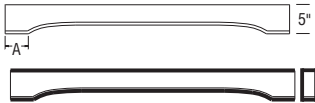

V525RA
V531RA
V537RA
V543RA
V549RA
V561RA
V573RA

Model	A =	Length
V525RA	4 1/4"	25"
V531RA	4 1/4"	31"
V537RA	4 1/4"	37"
V543RA	4 1/2"	43"
V549RA	4 1/2"	49"
V561RA	6"	61"
V573RA	6 3/4"	73"

NOTES ✓

- ▶ 3/4" thick.
- ▶ Valances not finished on back or ends.



Valances Straight, 5" High or 8 7/8" High

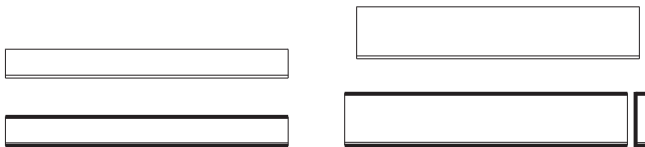

V531ST
V537ST
V540ST
V543ST
V546ST
V549ST
V561ST
V573ST

V937ST
V949ST
V961ST
V973ST

Model	Length
V531ST	31"
V537ST	37"
V540ST	40"
V543ST	43"
V546ST	46"
V549ST	49"
V561ST	61"
V573ST	73"
V937ST	37"
V949ST	49"
V961ST	61"
V973ST	73"

DESIGN SOLUTIONS

- ▶ 3/4" thick.
- ▶ Valances not finished on back or ends.



Finished edges indicated by bold lines on side view drawings.

- ▶ PEPR overlays available in Brellin, Briarcliff II, Durham, Eastland, Nantucket, and Wentworth. Must order separately under OL335 product code. (See page 148.)
- ▶ Plywood may contain MDF or particleboard in its core in accordance with ANSI/HPVA HP-1 standards.

Panels

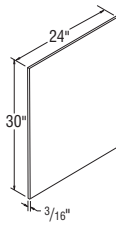

PDWP

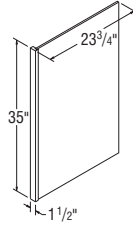

PEPR1.535
PEPR335 **

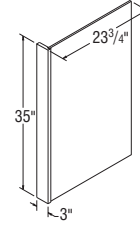

PEPRPLY1.535*
PEPRPLY335

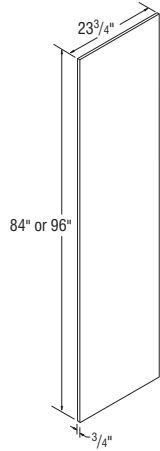

PREF2384
PREF2396

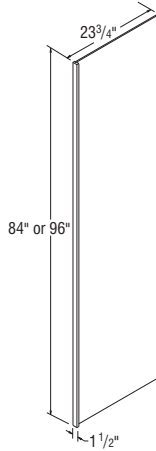

PREPRP1.584 †
PREPRP1.596 †

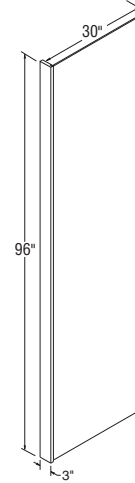

PREPR33096

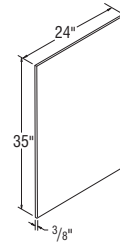

PSFEP

*When PEPRPLY1.535 is ordered in Rustic Finishes, rustic characteristics on Panel only.

**PEPR335 has rustic characteristics on Filler only.

†PREPRP1.584 and PREPRP1.596 will be laminate when ordered in White and Antique styles. When ordered in Rustic Finishes, rustic characteristics on Panels only.

Panel	Description	Size (T x W x H)	Edge Finish	Color Side 1	Color Side 2	Finish
PDWP	Dishwasher Front Panel	3/16" x 24" x 30"	None	Exterior	Raw	Veneer
PEPR1.535	Aristex™ 3/8" End Panel w/1 1/2" Stile	1 1/2" x 23 3/4" x 35"	Front Long	Exterior	Interior	Laminate
PEPR335 **	Aristex™ 3/8" End Panel w/3" Stile	3" x 23 3/4" x 35"	Front Long	Exterior	Interior	Laminate
PEPRPLY1.535 *	Plywood 3/8" End Panel w/1 1/2" Stile	1 1/2" x 23 3/4" x 35"	Front Long	Exterior	Interior	Veneer
PEPRPLY335	Plywood 3/8" End Panel/ Stile Complete	3" x 23 3/4" x 35"	Front Long	Exterior	Interior	Veneer
PREF2384	Particle Board Refrigerator End Panel	3/4" x 23 3/4" x 84"	1 Long	Exterior	Exterior	Veneer
PREF2396	Particle Board Refrigerator End Panel	3/4" x 23 3/4" x 96"	1 Long	Exterior	Exterior	Veneer
PREPRP1.584 †	Plywd. 3/8" Refrigerator End Panel w/1 1/2" Stile	1 1/2" x 23 3/4" x 84"	Front Long	Exterior	Exterior	Veneer
PREPRP1.596 †	Plywd. 3/8" Refrigerator End Panel w/1 1/2" Stile	1 1/2" x 23 3/4" x 96"	Front Long	Exterior	Exterior	Veneer
PREPR33096	Veneered Furniture Board Refrigerator 3/4" End Panel w/3" Stile	3" x 30" x 96"	Front Long	Exterior	Exterior	Veneer
PSFEP	Aristex™ Sink End Panel	3/8" x 24" x 35"	None	Exterior	Interior	Laminate



NOTES ✓

► Plywood may contain MDF or particleboard in its core in accordance with ANSI/HPVA HP-1 standards.

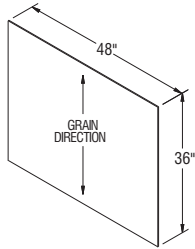

PA4836
P4836

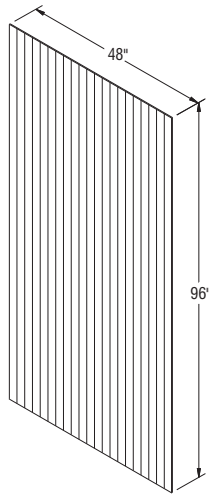

BP4896

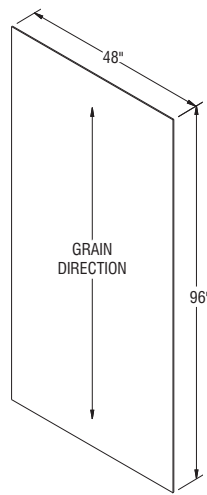

PA4896
P4896

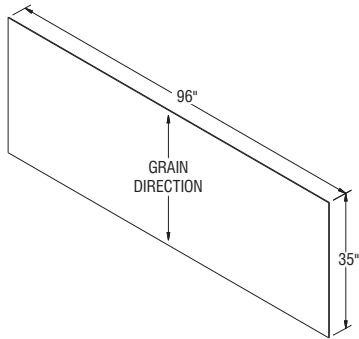

PP9635*

*PP9635 is not available in White or Antique finishes.

Panel	Description	Size (T x W x H)	Edge Finish	Color Side 1	Color Side 2	Finish
BP4896	Beadboard Panel	3/16" x 48" x 96"	None	Exterior	Raw	Veneer
PA4836	Stock Panel - Aristex™ Laminate	1/4" x 48" x 36"	None	Exterior	Raw	Laminate
PA4896	Stock Panel - Aristex™ Laminate	1/4" x 48" x 96"	None	Exterior	Raw	Laminate
PP9635 *	Stock Panel - Veneer	3/16" x 96" x 35"	None	Exterior	Raw	Veneer
P4836	Stock Panel - Veneer	3/16" x 48" x 36"	None	Exterior	Raw	Veneer
P4896	Stock Panel - Veneer	3/16" x 48" x 96"	None	Exterior	Raw	Veneer

NOTES ✓

- ▶ End Panels are shipped one per carton. Not sold in pairs.
- ▶ EPV1430 and EPV1442 are sized for 15" deep cabinets.
- ▶ Plywood may contain MDF or particleboard in its core in accordance with ANSI/HPVA HP-1 standards.



Veneer End Panels

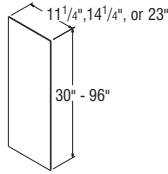

- EPV1130 EPV2335**
EPV1142 EPV2384
EPV1430 EPV2396
EPV1442

Panel	Description	Size (T x W x H)	Edge Finish	Color Side 1	Color Side 2	Finish
EPV1130	Wall End Panel for 12" Depth	3/16" x 11 1/4" x 30"	None	Exterior	Raw	Veneer
EPV1142	Wall End Panel for 12" Depth	3/16" x 11 1/4" x 42"	None	Exterior	Raw	Veneer
EPV1430	Wall End Panel for 15" Depth	3/16" x 14 1/4" x 30"	None	Exterior	Raw	Veneer
EPV1442	Wall End Panel for 15" Depth	3/16" x 14 1/4" x 42"	None	Exterior	Raw	Veneer
EPV2335	Base End Panel	3/16" x 23" x 35"	None	Exterior	Raw	Veneer
EPV2384	Utility End Panel	3/16" x 23" x 84"	None	Exterior	Raw	Veneer
EPV2396	Utility End Panel	3/16" x 23" x 96"	None	Exterior	Raw	Veneer

DESIGN SOLUTIONS

- ▶ 1/4" thick panels with one-sided Aristex™ laminate on exterior (no edge finish).
- ▶ End Panels are shipped one per carton. Not sold in pairs.
- ▶ EPA1430 and EPA1442 are sized for 15" deep cabinets.



Laminate End Panels

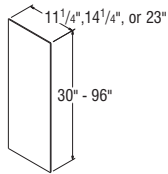

- EPA1130 EPA2335**
EPA1142 EPA2384
EPA1430 EPA2396
EPA1442

Panel	Description	Size (T x W x H)	Edge Finish	Color Side 1	Color Side 2	Finish
EPA1130	Wall End Panel for 12" Depth	1/4" x 11 1/4" x 30"	None	Exterior	Raw	Laminate
EPA1142	Wall End Panel for 12" Depth	1/4" x 11 1/4" x 42"	None	Exterior	Raw	Laminate
EPA1430	Wall End Panel for 15" Depth	1/4" x 14 1/4" x 30"	None	Exterior	Raw	Laminate
EPA1442	Wall End Panel for 15" Depth	1/4" x 14 1/4" x 42"	None	Exterior	Raw	Laminate
EPA2335	Base End Panel	1/4" x 23" x 35"	None	Exterior	Raw	Laminate
EPA2384	Utility End Panel	1/4" x 23" x 84"	None	Exterior	Raw	Laminate
EPA2396	Utility End Panel	1/4" x 23" x 96"	None	Exterior	Raw	Laminate

Decorative End Panels

NOTES

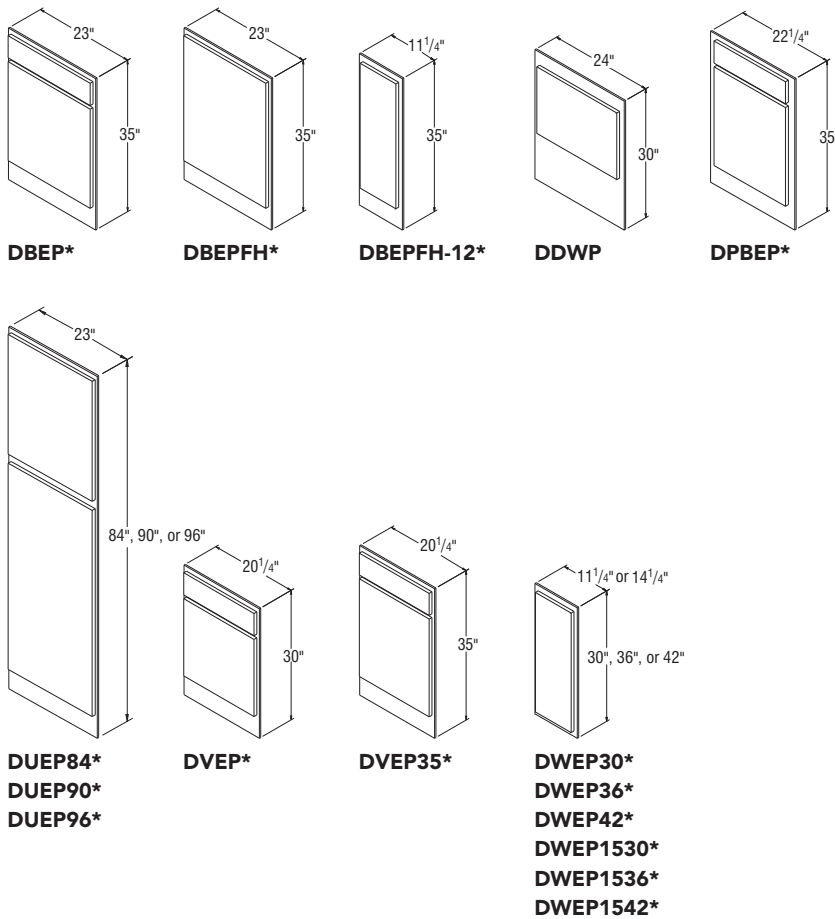

- ▶ DBEP and DPBEP include one door and one drawer front on an EP2335 Veneer End Panel and five screws for mounting.
- ▶ DBEPFH includes one door on an EP2335 Veneer End Panel and five screws for mounting.
- ▶ DBEPFH-12 includes one door on a Veneer Panel and five screws for mounting.
- ▶ DDWP includes one door, one Panel 24" x 30", and screws for installation. Shipped unassembled.
- ▶ DUEP includes two doors and one EP__ Veneer End Panel, and screws for assembly. Shipped assembled.
- ▶ DUEP includes three doors on miter styles.
- ▶ DVEP includes one door, one drawer front, and one Panel 20 1/4" x 30", and screws for assembly. Shipped assembled.
- ▶ DWEP parts include one door and an EP__ Veneer End Panel and four screws for mounting. Shipped assembled.
- ▶ Actual sizes of doors and drawer fronts used will vary slightly by style. For exact dimensions, refer to parts dimension guide.
- ▶ Panel construction is the same for Standard, Select, and APC.
- ▶ Plywood may contain MDF or particleboard in its core in accordance with ANSI/HPVA HP-1 standards.

*Specify L or R on full overlay styles for all Decorative Panels except DDWP.

Panel	Description	Size (T x W x H)	Edge Finish	Color Side 1	Color Side 2	Finish
DBEP & DBEPFH *	Decorative Base End	3/16" x 23" x 35"	None	Exterior	Raw	Veneer
DBEPFH-12 *	Decorative Base End for 12" Depth	3/16" x 11 1/4" x 35"	None	Exterior	Raw	Veneer
DDWP	Decorative Dishwasher Front	3/16" x 24" x 30"	None	Exterior	Raw	Veneer
DPBEP *	Decorative Peninsula Base End	3/16" x 22 1/4" x 35"	None	Exterior	Raw	Veneer
DUEP84 *	Decorative Utility End	3/16" x 23" x 84"	None	Exterior	Raw	Veneer
DUEP90 *	Decorative Utility End	3/16" x 23" x 90"	None	Exterior	Raw	Veneer
DUEP96 *	Decorative Utility End	3/16" x 23" x 96"	None	Exterior	Raw	Veneer
DVEP *	Decorative Vanity End	3/16" x 20 1/4" x 30"	None	Exterior	Raw	Veneer
DVEP35 *	Decorative Vanity End	3/16" x 20 1/4" x 35"	None	Exterior	Raw	Veneer
DWEP30 *	Decorative Wall End	3/16" x 11 1/4" x 30"	None	Exterior	Raw	Veneer
DWEP36 *	Decorative Wall End	3/16" x 11 1/4" x 36"	None	Exterior	Raw	Veneer
DWEP42 *	Decorative Wall End	3/16" x 11 1/4" x 42"	None	Exterior	Raw	Veneer
DWEP1530 *	Decorative Wall End for 15" Depth	3/16" x 14 1/4" x 30"	None	Exterior	Raw	Veneer
DWEP1536 *	Decorative Wall End for 15" Depth	3/16" x 14 1/4" x 36"	None	Exterior	Raw	Veneer
DWEP1542 *	Decorative Wall End	3/16" x 14 1/4" x 42"	None	Exterior	Raw	Veneer

NOTES ✓

- ▶ 3/4" thick.
- ▶ Veneer panel with front edge banded and both sides finished.



Vanity Tapered End Panel, 30" High, 21" Deep

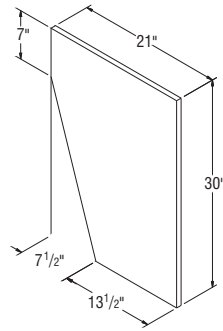

VTEP

NOTES ✓

- ▶ Rail, Panel, and Toekick.
- ▶ 27" opening.

DESIGN SOLUTIONS

- ▶ Use drawer front to cover bottom portion of panel.



Range Panel, 35" High

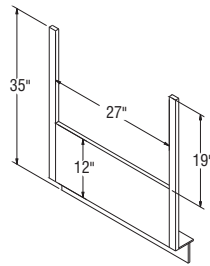

RP30

NOTES ✓

- ▶ Plywood may contain MDF or particleboard in its core in accordance with ANSI/HPVA HP-1 standards.



Toekick

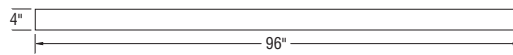

- TOEKICK8 (1 - 8' pc)**
- TOEKICK (4 - 8' pc)**
- TOEKICKPLY8 (1 - 8' pc)**

Panel	Description	Size (T x W x H)	Edge Finish	Color Side 1	Color Side 2	Finish
TOEKICK8	Aristex™ Toekick	1/4" x 4" x 96"	None	Exterior	Raw	Laminate
TOEKICK	Aristex™ Toekick	1/4" x 4" x 96"	None	Exterior	Raw	Laminate
TOEKICKPLY8	Plywood Toekick	1/4" x 4" x 96"	None	Exterior	Raw	Veneer

Toekick Cap

NOTES ✓

- ▶ TKC dimension: $\frac{3}{4}" \times 4" \times \frac{3}{4}"$
- ▶ Sold in pairs.

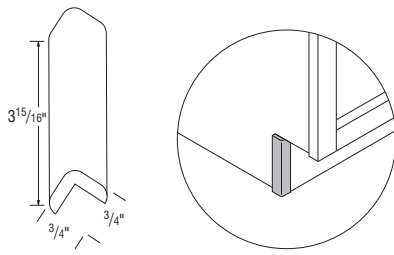

TKC

Exterior Shelves

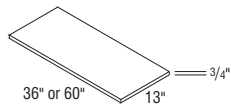

WSS36 (2/ctn.)
WSS60 (2/ctn.)

Shelf	Description	Size (T x W x D)	Edge Finish	Color Side 1	Color Side 2	Finish
WSS36	Wall System Shelves	$\frac{3}{4}" \times 36" \times 13"$	1 Long	Exterior	Exterior	Veneer
WSS60	Wall System Shelves	$\frac{3}{4}" \times 60" \times 13"$	1 Long	Exterior	Exterior	Veneer

Bookshelf Kit

NOTES ✓

- ▶ Recommended for use with Bookcase units where loads on shelves will exceed over 60 lbs.
- ▶ One Shelf Kit required per shelf.
- ▶ When ordered in a Rustic Birch style, will not feature rustic characteristics.

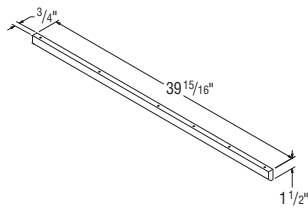

BKSHELFKIT*

*Order under door style number.

Appliance Centers (Under Wall Cabinet Accessory)

NOTES ✓

- ▶ AC2417.5 is designed to be used between countertop and Diagonal Wall cabinet.
- ▶ AC2417.5 designed to fit under DC24.
- ▶ AC2417.5 opening – 12" W x 14½" H.
- ▶ ACS1817.5 opening – 13" W x 14½" H.
- ▶ ACS2417.5 opening – 19" W x 14½" H.
- ▶ ACS3017.5 opening – 25" W x 14½" H.

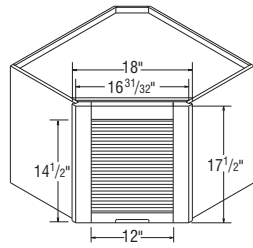

Diagonal

AC2417.5

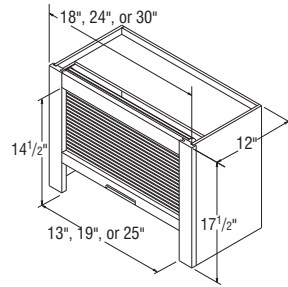

Straight

ACS1817.5
ACS2417.5
ACS3017.5

Stem Glass Holders (Under Wall Cabinet Accessory)

NOTES ✓

- ▶ Designed to be mounted underneath a standard Wall cabinet.
- ▶ SGH30 holds 7 rows.
- ▶ SGH36 holds 9 rows.

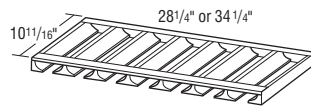

SGH30
SGH36

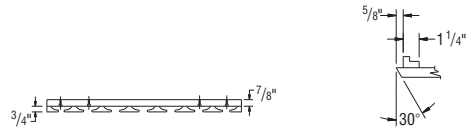

Side View

Organizer Shelves (Under Wall Cabinet Accessory)

NOTES ✓

- ▶ Designed to mount underneath Wall cabinet.
- ▶ Top, bottom, and sides are finished.

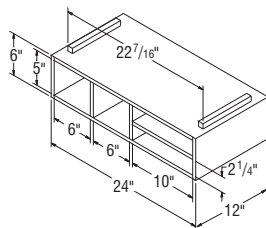

ORG24

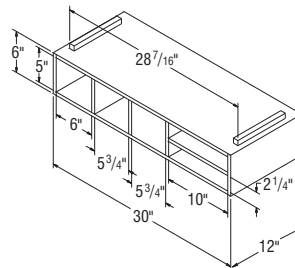

ORG30

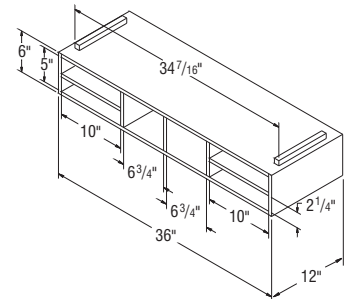

ORG36

Stem Glass Holders (Wall Open Cabinet Accessory)

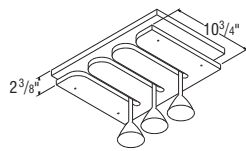

SGH18
SGH21

NOTES ✓

- ▶ One 3/4" thick matching Aristex™ shelf mounted to each Stem Glass Holder.
- ▶ Stem Glass Holder is installed by placing shelf in position with included shelf clips.
- ▶ SGH18 fits 18" wide Wall cabinets.
- ▶ SGH21 fits 21" wide Wall cabinets.



Wall Spice Racks (Wall Cabinet Accessory)

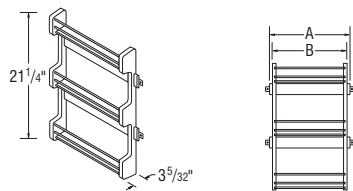

SRD15
SRD18
SRD21

NOTES ✓

- ▶ Natural wood finish with chrome bars.
- ▶ Designed for Wall cabinets (30", 36", and 42" high), Base cabinets, Utility cabinets, and Linen Closet cabinets. Make sure to avoid interference with Roll Trays, full depth shelves, or other interior cabinet accessories.
- ▶ Mounts to door frame with provided screws.
- ▶ Order under style #010.

DESIGN SOLUTIONS

- ▶ Great for use in the bathroom to hold vitamins, medications, etc.



Model	Recommended	A Dimension	B Dimension
SRD15	15" or 30" wide	10 1/2"	9 1/2" wide
SRD18	18" or 36" wide	13 1/2"	12 1/2" wide
SRD21	21" or 42" wide	16 1/2"	15 1/2" wide

NOTES ✓

- ▶ PDO includes 8 wooden posts and board.
- ▶ PDOPOSTS includes 4 wooden posts.
- ▶ Pegged board is 3/8" thick.
- ▶ Recommended for use in DB36, DB36-4, DBFP36, and DBFP36-4. Pegged board can be trimmed for use in smaller applications.
- ▶ Order under style #010.

Pegged Dish Organizer (Drawer Accessory)

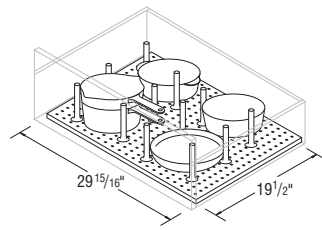

PDO



PDOPOSTS



NOTES ✓

- ▶ Place a cabinet with a PCDT or WCDDT next to the dishwasher for convenience.
- ▶ PCDT - plastic.
- ▶ WCDDT - wood.
- ▶ PCDT is designed to fit in the Particle Board (PABD) drawer box only.
- ▶ The WCDDT can be cut to fit either wood or Particle Board (PABD) drawer boxes.

Wood and Plastic Cutlery Tray

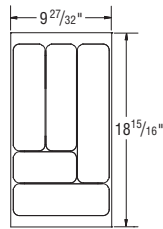

PCDT15

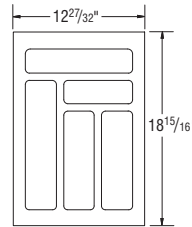

PCDT18

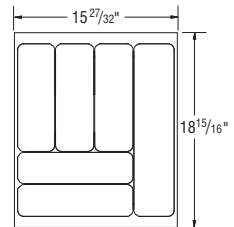

PCDT21

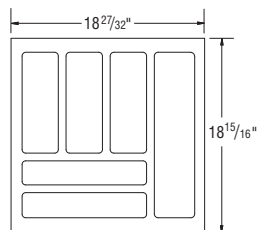
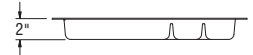
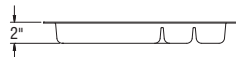

PCDT24

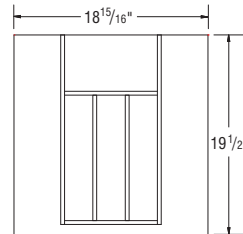

WCDDT

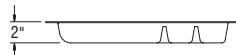

SKU	Width	Depth	Usage Details
PCDT15	9 27/32"	18 15/16"	Designed to be used in 12 7/8" wide Particle Board Drawer Boxes.
PCDT18	12 27/32"	18 15/16"	Designed to be used in 15 7/8" wide Particle Board Drawer Boxes.
PCDT21	15 27/32"	18 15/16"	Designed to be used in 18 7/8" wide Particle Board Drawer Boxes.
PCDT24	18 27/32"	18 15/16"	Designed to be used in 21 7/8" wide Particle Board Drawer Boxes.
WCDDT	18 15/16"	19 1/2"	Designed to fit in all wood drawer boxes. Can be trimmed to fit in Particle Board Drawer Boxes.

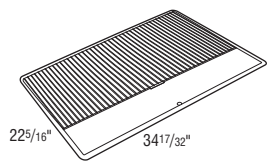

CABMAT36

- ▶ Designed to capture spills and is removable for cleaning.
- ▶ Will contain a spill of up to 3 quarts (2.8 liters).
- ▶ CABMAT36 is not trimmable.

Glass Shelf Kits, 12" Deep

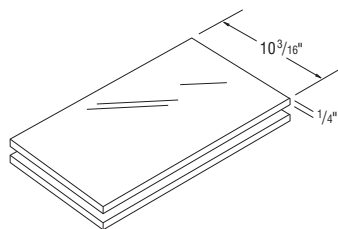

- GSK1512**
- GSK1812**
- GSK2112**
- GSK2412**
- GSK3012**
- GSK3612**

- ▶ Meets KCMA standards of 15 lbs. per square foot.
- ▶ Cannot be trimmed.
- ▶ Kit includes two 1/4" thick tempered glass shelves and shelf clips.
- ▶ Order under style #010.



Glass Shelf Kits, Diagonal

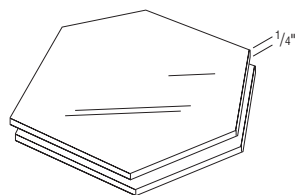

Fits DC...24
GSKDC24

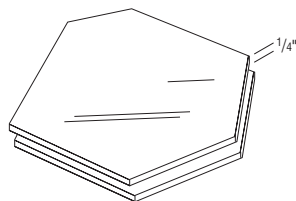

Fits DC...27
GSKDC27

- ▶ Meets KCMA standards of 15 lbs. per square foot.
- ▶ Cannot be trimmed.
- ▶ Kit includes two 1/4" thick tempered glass shelves and shelf clips.
- ▶ Order under style #010.



NOTES ✓

- ▶ Sold in pairs.
- ▶ Used to deflect heat from self-cleaning ovens, away from cabinet doors and drawer fronts.
- ▶ Includes installation screws.
- ▶ White finish.
- ▶ For use on cabinets next to an oven/range when an additional $\frac{1}{8}$ " cannot be added to the oven manufacturer's recommended space requirement between the oven and each adjacent cabinet.
- ▶ Cabinet door cannot be hinged on the same side as the angled heat shield, not compatible with double door cabinets.
- ▶ Installs on the front of the face frame of each cabinet adjacent to the oven.



Heat Shield, Angled

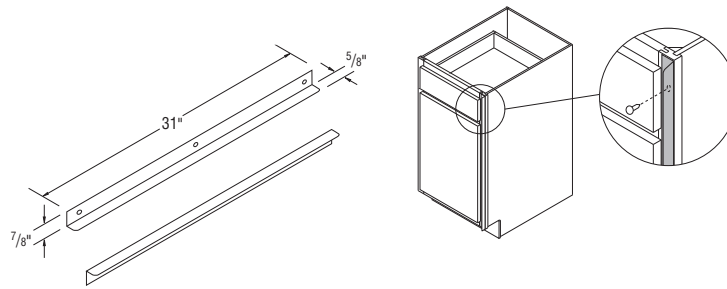

HEATSHIELDAN

NOTES ✓

- ▶ Sold in pairs.
- ▶ Used to deflect heat from self-cleaning ovens, away from cabinet doors and drawer fronts.
- ▶ Includes installation screws.
- ▶ White finish.
- ▶ For use on cabinets next to an oven/range when an additional $\frac{1}{8}$ " can be added to the oven manufacturer's recommended space requirement.
- ▶ Installs on the side of the face frame of each cabinet adjacent to the oven.



Heat Shield, Straight

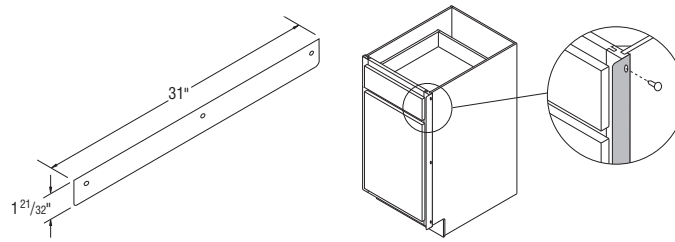

HEATSHIELDST

NOTES ✓

- ▶ Two metal brackets to support ovens and microwaves.
- ▶ Designed to be used with OCSD, OD, and OMS cabinets.
- ▶ Cabinet not included.
- ▶ Order under style #010.



Oven Installation Kit

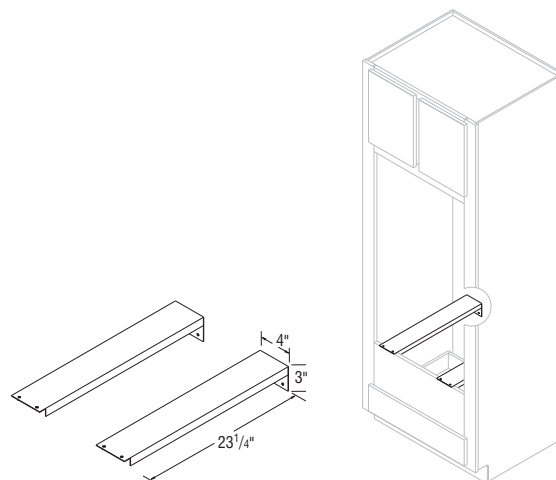

OCINSTALLKIT

PRODUCT CODES	Dimensions	Natural Maple Laminate	White Laminate	Plywood	Fits 12" Deep	Fits 24" Deep
---------------	------------	------------------------	----------------	---------	---------------	---------------

Utility Shelf Kits

NOTES

- ▶ Utility Shelf Kits contain two shelves and eight clips.
- ▶ Shelves are 3/4" thick.
- ▶ Maximum weight per square foot is 15 lbs.
- ▶ Utility Shelf Kits are natural maple laminate or specify UKS_ _WH for white.
- ▶ Order under style #010.



UKS15	13 1/2" x 22 1/2"	✓				✓
UKS15WH	13 1/2" x 22 1/2"		✓			✓
UKS18	16 1/2" x 22 1/2"	✓				✓
UKS18WH	16 1/2" x 22 1/2"		✓			✓
UKS24	22 1/2" x 22 1/2"	✓				✓
UKS24WH	22 1/2" x 22 1/2"		✓			✓
UKS30	28 1/2" x 22 1/2"	✓				✓
UKS30WH	28 1/2" x 22 1/2"		✓			✓
UKS36	34 1/2" x 22 1/2"	✓				✓
UKS36WH	34 1/2" x 22 1/2"		✓			✓
UKS1512	13 1/2" x 10 11/32"	✓			✓	
UKS1512WH	13 1/2" x 10 11/32"		✓		✓	
UKS1812	16 1/2" x 10 11/32"	✓			✓	
UKS1812WH	16 1/2" x 10 11/32"		✓		✓	
UKS2412	22 1/2" x 10 11/32"	✓			✓	
UKS2412WH	22 1/2" x 10 11/32"		✓		✓	
UKS3012	28 1/2" x 10 11/32"	✓			✓	
UKS3012WH	28 1/2" x 10 11/32"		✓		✓	
UKS3612	34 1/2" x 10 11/32"	✓			✓	
UKS3612WH	34 1/2" x 10 11/32"		✓		✓	
UKS15PL	13 1/2" x 22 1/2"	✓		✓		✓
UKS15WHPL	13 1/2" x 22 1/2"		✓	✓		✓
UKS18PL	16 1/2" x 22 1/2"	✓		✓		✓
UKS18WHPL	16 1/2" x 22 1/2"		✓	✓		✓
UKS24PL	22 1/2" x 22 1/2"	✓		✓		✓
UKS24WHPL	22 1/2" x 22 1/2"		✓	✓		✓
UKS30PL	28 1/2" x 22 1/2"	✓		✓		✓
UKS30WHPL	28 1/2" x 22 1/2"		✓	✓		✓
UKS36PL	34 1/2" x 22 1/2"	✓		✓		✓
UKS36WHPL	34 1/2" x 22 1/2"		✓	✓		✓
UKS1512PL	13 1/2" x 10 11/32"	✓		✓	✓	
UKS1512WHPL	13 1/2" x 10 11/32"		✓	✓	✓	
UKS1812PL	16 1/2" x 10 11/32"	✓		✓	✓	
UKS1812WHPL	16 1/2" x 10 11/32"		✓	✓	✓	
UKS2412PL	22 1/2" x 10 11/32"	✓		✓	✓	
UKS2412WHPL	22 1/2" x 10 11/32"		✓	✓	✓	
UKS3012PL	28 1/2" x 10 11/32"	✓		✓	✓	
UKS3012WHPL	28 1/2" x 10 11/32"		✓	✓	✓	
UKS3612PL	34 1/2" x 10 11/32"	✓		✓	✓	
UKS3612WHPL	34 1/2" x 10 11/32"		✓	✓	✓	

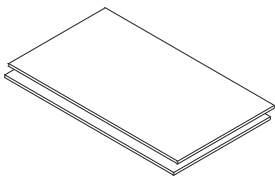

Utility Shelf Kit Shelves

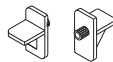

Utility Shelf Kit Clips

NOTES ✓

- ▶ Pantry Roll Tray Kits feature 1/2" thick solid wood front and furniture board sides and back, or specify UPK_ _WH for white.
- ▶ Pantry Roll Tray Kits contain four trays, eight suspension tracks, and eight bumper pads with installation screws.
- ▶ Maximum weight per square foot is 15 lbs.
- ▶ Pantry Roll Tray Kits cannot be used in any Utility cabinet 12" deep.
- ▶ Order under style #010.
- ▶ Smart Stop™ Pantry Roll Tray Kits are not available.

DESIGN SOLUTIONS

- ▶ Shelf or Roll Tray Kits can be used to convert a standard Utility cabinet into a Pantry.



Pantry Roll Tray Kit

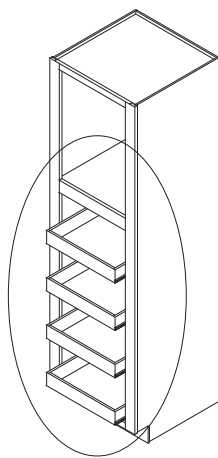

Pantry Roll Tray Kit

UPK15

UPK15WH

UPK18

UPK18WH

UPK24

UPK24WH

UPK30

UPK30WH

UPK36

UPK36WH

Model	Dimensions	Natural Maple Laminate	White Laminate	Thickness
UPK15	10 ¹¹ / ₁₆ " x 20 ³ / ₁₆ "	✓		3 ¹ / ₈ "
UPK15WH	10 ¹¹ / ₁₆ " x 20 ³ / ₁₆ "		✓	3 ¹ / ₈ "
UPK18	13 ¹¹ / ₁₆ " x 20 ³ / ₁₆ "	✓		3 ¹ / ₈ "
UPK18WH	13 ¹¹ / ₁₆ " x 20 ³ / ₁₆ "		✓	3 ¹ / ₈ "
UPK24	19 ¹¹ / ₁₆ " x 20 ³ / ₁₆ "	✓		3 ¹ / ₈ "
UPK24WH	19 ¹¹ / ₁₆ " x 20 ³ / ₁₆ "		✓	3 ¹ / ₈ "
UPK30	25 ¹¹ / ₁₆ " x 20 ³ / ₁₆ "	✓		3 ¹ / ₈ "
UPK30WH	25 ¹¹ / ₁₆ " x 20 ³ / ₁₆ "		✓	3 ¹ / ₈ "
UPK36	31 ¹¹ / ₁₆ " x 20 ³ / ₁₆ "	✓		3 ¹ / ₈ "
UPK36WH	31 ¹¹ / ₁₆ " x 20 ³ / ₁₆ "		✓	3 ¹ / ₈ "

NOTES ✓

- ▶ Roll Tray Kits feature 1/2" thick solid wood front and furniture board sides and back, or specify TKIT_ _WH for white.
- ▶ Maximum weight per square foot is 15 lbs.
- ▶ All guides are white.
- ▶ Order under style #010.
- ▶ See Storage Accessories Matrix on pages 174 & 175.
- ▶ Bumper pads for field installation included.
- ▶ Smart Stop™ Roll Tray Kits are not available.

DESIGN SOLUTIONS

- ▶ An additional Roll-Out Tray can be installed above the Base cabinet half-depth shelf.



Roll Tray Kits

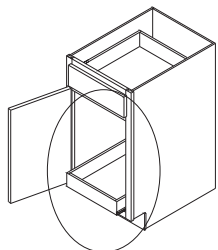

TKIT15

TKIT15WH

TKIT18

TKIT18WH

TKIT21

TKIT21WH

TKIT24

TKIT24WH

TKIT27

TKIT27WH

TKIT30

TKIT30WH

TKIT33

TKIT33WH

TKIT36

TKIT36WH

TKIT39

TKIT39WH

TKIT45

TKIT45WH

Model	Recommended Width of Face Frame Opening	Trays	Track Sliders	Mounting Blocks	2 1/2" Wood Screws	5/8" Wood Screws	1/8" Spacers
TKIT15	12"	1	2	2	2	4	2
TKIT15WH	12"	1	2	2	2	4	2
TKIT18	15"	1	2	2	2	4	2
TKIT18WH	15"	1	2	2	2	4	2
TKIT21	18"	1	2	2	2	4	2
TKIT21WH	18"	1	2	2	2	4	2
TKIT24	21"	1	2	2	2	4	2
TKIT24WH	21"	1	2	2	2	4	2
TKIT27	24"	1	2	2	2	4	2
TKIT27WH	24"	1	2	2	2	4	2
TKIT30	27"	1	2	2	2	4	2
TKIT30WH	27"	1	2	2	2	4	2
TKIT33	30"	1	2	2	2	4	2
TKIT33WH	30"	1	2	2	2	4	2
TKIT36	33"	1	2	2	2	4	2
TKIT36WH	33"	1	2	2	2	4	2
TKIT39	16 1/2"	2	4	4	2	8	2
TKIT39WH	16 1/2"	2	4	4	2	8	2
TKIT45	19 1/2"	2	4	4	2	8	2
TKIT45WH	19 1/2"	2	4	4	2	8	2

Chrome Tray Divider Kit *New*

DESIGN SOLUTIONS

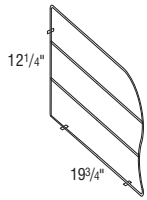

CTDK

- ▶ Not recommended in BMD...FH, BMD...FHB, BPG...FH, BPG...FHB.
- ▶ Includes 1 divider, 3 clips.
- ▶ Tray divider is chrome wire.

Roll Tray Bumper Pad

NOTES ✓

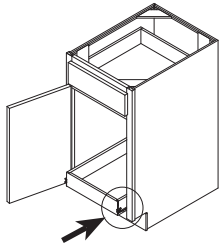

RTBP

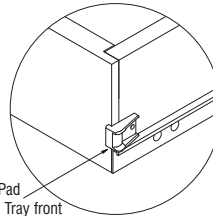

Place Bumper Pad on edge of Roll Tray front on top of Roll Tray Slide.

- ▶ RTBP includes two bumpers and two screws for installation.
- ▶ Used to protect door from roll tray corners.
- ▶ Included with roll tray cabinets and with roll tray kits.
- ▶ Can be retrofitted to all roll trays.
- ▶ Order under style #010.



Double Wastebasket Roll-Out Kit

NOTES ✓

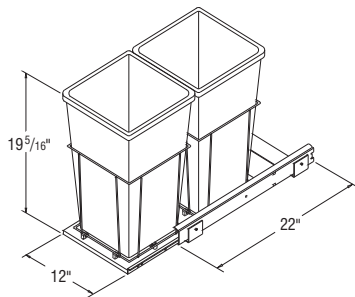

DWBR*

*Fits 15" wide Base cabinet.

- ▶ White epoxy coated wire with Full Extension guides (non Smart Stop™).
- ▶ Includes two 27 quart Wastebaskets with wire storage compartment.
- ▶ Mounted on white melamine board and installs to floor of cabinet.
- ▶ Order under style #010.
- ▶ Installation of this accessory requires removing half-depth shelf. See matrix on pages 174 & 175 for installation recommendations.



NOTES ✓

- ▶ Pulls to add to the false front must be ordered separately.
- ▶ If STOTs are used on a full overlay style, it is recommended that a pull be used.
- ▶ STOT30WH & STOT36WH are for cabinets with two false fronts.
- ▶ STOT30WHB & STOT36WHB are for cabinets with one false front.
- ▶ Two white trays, 2¼" deep.
- ▶ Order under style #010.
- ▶ See Storage Accessory Matrix on pages 174 & 175.



Sink Tip-Out Trays

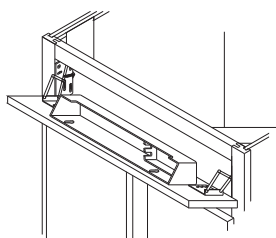

STOT30WH
STOT36WH
STOT30WHB
STOT36WHB

Model	Cabinet Width	Description
STOT30WH	30"	two 11½" white trays, 4 hinges
STOT36WH	36"	two 14½" white trays, 4 hinges
STOT30WHB	30"	two 11½" white trays, 2 hinges
STOT36WHB	36"	two 14½" white trays, 2 hinges

NOTES ✓

- ▶ Creates a smooth and silent closing motion.
- ▶ Recommended usage per cabinet: 1 per door on any door with 2 hinges and 2 per door on any door with 3 or more hinges (cabinets under 36" high have 2 hinges, 36" and higher have 3 hinges). Additional units may be required when an accessory item is attached to the cabinet door.
- ▶ Not recommended for use on bi-fold doors or Base SuperCabinets™.



Smart Stop Door Mechanism

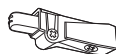

SSDM

Hinges

HINGE6WAY*

*Order under door style number.

Frame Spacers *New*

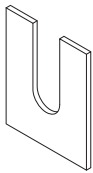

HNGSPCRF
HNGSPCRF50

NOTES ✓

- ▶ For use to provide additional door adjustment in field.
- ▶ Designed to be placed between the face frame and hinge mounting plate.
- ▶ HNGSPCRF sold in pairs.
- ▶ HNGSPCRF50 sold in packs of 50.

Hinge Spacers *New*

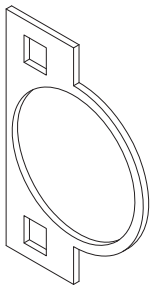

HNGSPCRD
HNGSPCRD50

NOTES ✓

- ▶ For use to provide additional door adjustment in field.
- ▶ Designed to be placed around the hinge cup and against the back of the door.
- ▶ HNGSPCRD sold in pairs.
- ▶ HNGSPCRD50 sold in packs of 50.

Hinge Angle Restrictor Clips *New*



HNGRESCLP

NOTES ✓

- ▶ For use in applications with cabinets installed at varying depths to prevent the door damage caused by opening into an adjacent cabinets.
- ▶ Restricts hinges to 86 degree opening capability.
- ▶ Not recommended for cabinets with roll trays specified in partial overlay styles.
- ▶ Sold in pairs.

NOTES ✓

- ▶ Order 1 pint of Toner for 1 quart of Stain.
- ▶ For white and antique styles, Touch-Up is only recommended for face frames and End Panels.
- ▶ Use Maple/Birch for Rustic finishes.



Stain, Toner, and Touch-Up

Touch-Up Kit

TUKIT*



Pint of Toner

TONERPT**



Pint of Stain

STAINPT**

Quart of Stain

STAINQT**

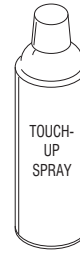

Touch-Up Spray Can

TUPSPRAY****

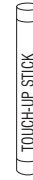

Touch-Up Stick

TUPSTICK***

*Touch-Up Kit contains one felt marker and one putty stick.

**TONEPT, STAINPT, and STAINQT are not available in Antique, Glacier Gray, or White.

***Touch-Up Stick – when ordering TUPSTICK, a single putty stick in the selected color is sent.

****TUPSPRAY is a 13 oz. can (400 ml)

Wood Specie	Color	TONERPT Required	STAINPT or STAINQT Required
Cherry	Café	✓	✓
	Flagstone	✓	✓
	Java Glaze	✓	✓
	Pumpnickel Glaze	✓	✓
	Rouge	✓	✓
	Saddle	✓	✓
	Umber	✓	✓
	Wheat	•	✓
Hickory	Saddle	✓	✓
	Wheat	•	✓
Maple/Birch	Autumn	✓	✓
	Café	✓	✓
	Fawn	✓	•
	Flagstone	✓	✓
	Java Glaze	✓	✓
	Pumpnickel Glaze	✓	✓
	Rouge	✓	✓
	Saddle	✓	✓
	Sarsaparilla	✓	✓
	Umber	✓	✓
Oak	Saddle	✓	✓
	Sarsaparilla	✓	✓
	Umber	✓	✓
	Wheat	•	✓

	PRODUCT CODE	Item Description	Finish/Color	Drill Center
	H112	Knob 1¼"	Black Chrome	N/A
	H167	Knob 1¼"	Polished Brass Plated	N/A
	H300	Knob 1¼"	Patina Black	N/A
	H302 *	Pull 4¾"	Patina Black	4"
	H303	Knob 1¼"	Patina Black	N/A
	H304 *	Pull 4¾"	Patina Rouge	4"
	H305	Knob 1¼"	Patina Rouge	N/A
	H307	Knob 1¼"	Patina Rouge	N/A
	H311 *	Pull 5⅔"	Antique Pewter	128mm
	H312 *	Cup Pull 2½"	Antique Pewter	64mm
	H313	Knob 1¼"	Antique Pewter	N/A
	H314 *	Pull 4⅞"	Brushed Satin Nickel	96mm
	H315 *	Pull 5⅓"	Brushed Satin Nickel	128mm
	H316	Knob 1¼"	Brushed Satin Nickel	N/A
	H317	Knob 1¼"	Polished Chrome	N/A

- ▶ Screws included with hardware.
- ▶ Order under style #010.
- ▶ Hardware is recommended for use on all full overlay and miter door styles (except Avalon and Radford). All other door styles have a reverse bevel and hardware is not required.

▶ For 5-Piece drawer front panel dimensions, please see page 178.

*Hardware does not fit certain door styles with 5-Piece drawers because of small width of recessed center drawer panel.



Hardware Chart





- ▶ Screws included with hardware.
- ▶ Order under style #010.
- ▶ Hardware is recommended for use on all full overlay and miter door styles (except Avalon and Radford). All other door styles have a reverse bevel and hardware is not required.

▶ **For 5-Piece drawer front panel dimensions, please see page 178.**

*Hardware does not fit certain door styles with 5-Piece drawers because of small width of recessed center drawer panel.



	PRODUCT CODE	Item Description	Finish/Color	Drill Center
	H318 *	Pull 5 ³ / ₈ "	Flat Black	128mm
	H319	Large Flower Twist Knob 1 ¹ / ₄ "	Pewter	N/A
	H323	Knob 1 ¹ / ₄ "	Flat Black	N/A
	H332 *	Pull 5"	Brushed Satin Nickel	96mm
	H333 *	Pull 4 ³ / ₈ "	Oil Rubbed Bronze	4"
	H334	Knob 1 ¹ / ₄ "	Oil Rubbed Bronze	N/A
	H335 *	Birdcage Pull 4 ¹ / ₃ "	Pewter	4"
	H336 *	Pull 5 ³ / ₈ "	Venetian Bronze	128mm
	H337 *	Birdcage Pull 4 ¹ / ₃ "	Venetian Bronze	4"
	H338 *	Pull 5"	Black Chrome	96mm
	H339	Birdcage Knob 1 ¹ / ₄ "	Venetian Bronze	N/A
	H340	Knob 1 ¹ / ₄ "	Venetian Bronze	N/A
	H343 *	Pull 6 ¹⁹ / ₆₄ "	Brushed Satin Nickel	128mm
	H344	Pull 4 ¹ / ₂ "	Brushed Satin Nickel	96mm
	H345	Knob 1 ¹ / ₄ "	Brushed Satin Nickel	N/A
	H346	Pull 4 ¹ / ₈ "	Brushed Satin Nickel	96mm

	PRODUCT CODE	Item Description	Finish/Color	Drill Center
	H347	Pull 4 1/8"	Brushed Satin Nickel	3"
	H348	Knob 1 1/16"	Brushed Satin Nickel	N/A
	H349	Pull 7"	Brushed Satin Nickel	96mm
	H350	Pull 8 1/5"	Brushed Satin Nickel	128mm

- ▶ Screws included with hardware.
- ▶ Order under style #010.
- ▶ Hardware is recommended for use on all full overlay and miter door styles (except Avalon and Radford). All other door styles have a reverse bevel and hardware is not required.

▶ **For 5-Piece drawer front panel dimensions, please see page 178.**

*Hardware does not fit certain door styles with 5-Piece drawers because of small width of recessed center drawer panel.



Traditional Storage Accessory Matrix

KEY

- F** Must remove full-depth shelf.
- H** Must remove half-depth shelf.
- I** Can be installed without modification to cabinet.
- P** Location of plumbing should be checked prior to installation of storage accessory.
- ✓ Recommended for ideal fit, and can be installed without modification to cabinet.
- Not applicable.
- * Roll-Out Kits also available in white, specify TKIT_ _WH.
- † Only one tray will fit.

Cabinet	Double Wastebasket Roll-Out	STOT30WH Sink Tip-Out Tray 30" Two 11 1/2" trays, 4 hinges	STOT30WHB Sink Tip-Out Tray 30" Two 11 1/2" trays, 2 hinges	STOT36WH Sink Tip-Out Tray 36" Two 14 1/2" trays, 4 hinges	STOT36WHB Sink Tip-Out Tray 36" Two 14 1/2" trays, 2 hinges	Roll-Out Kit*
B12	•	•	•	•	•	•
B12TD	•	•	•	•	•	•
B15	H	•	•	•	•	TKIT15
B15RT	•	•	•	•	•	TKIT15
B18	H	•	•	•	•	TKIT18
B18RT	•	•	•	•	•	TKIT18
B21	H	•	•	•	•	TKIT21
B21RT	•	•	•	•	•	TKIT21
B24	H	•	•	•	•	TKIT24
B24RT	•	•	•	•	•	TKIT24
B24DD	H	•	•	•	•	TKIT24
B24DDRT	•	•	•	•	•	TKIT24
B27B	•	•	•	•	•	TKIT27
B27RTB	•	•	•	•	•	TKIT27
B30B	H	•	•	•	•	TKIT30
B30RTB	•	•	•	•	•	TKIT30
B33B	H	•	•	•	•	TKIT33
B33RTB	•	•	•	•	•	TKIT33
B36B	H	•	•	•	•	TKIT36
B36RTB	•	•	•	•	•	TKIT36
B39	H	•	•	•	•	TKIT39
B39RT	•	•	•	•	•	TKIT39
B42	H	•	•	•	•	TKIT21
B42RT	•	•	•	•	•	TKIT21
B45	H	•	•	•	•	TKIT45
B45RT	•	•	•	•	•	TKIT45
B48	H	•	•	•	•	TKIT24
B48RT	•	•	•	•	•	TKIT24
B15FH	✓	•	•	•	•	TKIT15
B18FH	I	•	•	•	•	TKIT18
B21FH	I	•	•	•	•	TKIT21
B24FH	I	•	•	•	•	TKIT24
B30FHB	I	•	•	•	•	TKIT30
B36FHB	I	•	•	•	•	TKIT36
BWB15FH	•	•	•	•	•	•
BWB18	•	•	•	•	•	•
BWB21	•	•	•	•	•	•
BC36	•	•	•	•	•	•
BC39	H	•	•	•	•	•
BC42	H	•	•	•	•	TKIT15
BC45	H	•	•	•	•	TKIT18
BC48	H	•	•	•	•	TKIT39
BC51	H	•	•	•	•	TKIT21

Traditional Storage Accessory Matrix

NOTES 

Cabinet	Double Wastebasket Roll-Out	STOT30WH Sink Tip-Out Tray 30" Two 1 1/2" trays, 4 hinges	STOT30WHB Sink Tip-Out Tray 30" Two 1 1/2" trays, 2 hinges	STOT36WH Sink Tip-Out Tray 36" Two 1 1/2" trays, 4 hinges	STOT36WHB Sink Tip-Out Tray 36" Two 1 1/2" trays, 2 hinges	Roll-Out Kit*
SCER36	•	•	•	•	•	•
SB24	P	I [†]	•	I [†]	•	TKIT24
SB24DD	P	I [†]	•	I [†]	•	TKIT24
SB27B	P	I [†]	•	•	•	TKIT27
SB30B	P	•	✓	•	•	TKIT30
SB33B	P	•	✓	•	•	TKIT33
SB36B	P	•	I	•	✓	TKIT36
SB39	P	I	•	I	•	TKIT39
SB42	P	I	•	I	•	TKIT21
SB45	P	I	•	I	•	TKIT45
SB48	P	I	•	I	•	TKIT24
SBDC36	P	I [†]	•	•	•	•
SBDC42	P	I [†]	•	I [†]	•	•
SF30 (POL)	P	I [†]	•	I [†]	•	•
SF30B (FOL)	P	I	•	•	•	•
SF36B (POL)	P	•	I	•	•	•
SF36B (FOL)	P	•	I	•	✓	•
SF42	P	I	•	✓	•	•
SF48	P	I	•	I	•	•
SFC36	P	I [†]	•	•	•	•
SFC42	P	I [†]	•	I [†]	•	•
PB18	F	•	•	•	•	•
PB24	F	•	•	•	•	•
PB24DD	F	•	•	•	•	•
PB30B	F	•	•	•	•	•
PB36B	F	•	•	•	•	•
PB42	F	•	•	•	•	•
PB48	F	•	•	•	•	•
PBSC27B	F	•	•	•	•	•
PBSC42	F	•	•	•	•	•
PBSC48	F	•	•	•	•	•
U15/U1590/U1596	I	•	•	•	•	TKIT15
U18/U1890/U18596	I	•	•	•	•	TKIT18
U24/U2490/U2496	I	•	•	•	•	TKIT24
U30B/U3090B/U3096B	I	•	•	•	•	TKIT30
U36B/U3690B/U3696B	I	•	•	•	•	TKIT36
B30FH32.5B	I	•	•	•	•	TKIT30
B33FH32.5B	I	•	•	•	•	TKIT33
B36FH32.5B	I	•	•	•	•	TKIT36
SB3032.5B	•	•	✓	•	•	TKIT30
SB3632.5B	•	•	I	•	✓	TKIT36
U1832.5	I	•	•	•	•	TKIT18
U2432.5	I	•	•	•	•	TKIT24

KEY

- F** Must remove full-depth shelf.
- H** Must remove half-depth shelf.
- I** Can be installed without modification to cabinet.
- P** Location of plumbing should be checked prior to installation of storage accessory.
- ✓ Recommended for ideal fit, and can be installed without modification to cabinet.
- Not applicable.
- * Roll-Out Kits also available in white, specify TKIT__WH.
- † Only one tray will fit.

Glass Size Chart for Wall Prepped for Glass Cabinets

ACCESSORIES AND PARTS

	Briarcliff II Dryden Durham Eastland Overton Wentworth		Brellin		Korbett		Harrison Winstead		Benton Saybrooke		Grayson Landen		Ayden Avalon Oakland Pioneer Radford Sinclair Westbury	
	Width	Height	Width	Height	Width	Height	Width	Height	Width	Height	Width	Height	Width	Height
RECOMMENDED GLASS SIZES														
BPG2412FH	18 ⁵ / ₈ "	25 ¹ / ₄ "	19 ¹³ / ₁₆ "	26 ⁷ / ₁₆ "	18 ¹ / ₄ "	24 ⁷ / ₈ "	19 ⁷ / ₈ "	26 ¹ / ₂ "	18 ¹ / ₄ "	25 ¹ / ₄ "	17 ¹ / ₈ "	24 ⁷ / ₈ "	18 ⁵ / ₈ "	25 ⁵ / ₈ "
BPG2415FH	18 ⁵ / ₈ "	25 ¹ / ₄ "	19 ¹³ / ₁₆ "	26 ⁷ / ₁₆ "	18 ¹ / ₄ "	24 ⁷ / ₈ "	19 ⁷ / ₈ "	26 ¹ / ₂ "	18 ¹ / ₄ "	25 ¹ / ₄ "	17 ¹ / ₈ "	24 ⁷ / ₈ "	18 ⁵ / ₈ "	25 ⁵ / ₈ "
BPG3012FHB	9 ¹ / ₁₆ "	25 ¹ / ₄ "	11"	26 ⁷ / ₁₆ "	9 ⁷ / ₁₆ "	24 ⁷ / ₈ "	11 ¹ / ₁₆ "	26 ¹ / ₂ "	10 ¹ / ₄ "	25 ¹ / ₄ "	9 ¹ / ₈ "	24 ⁷ / ₈ "	10 ⁵ / ₈ "	25 ⁵ / ₈ "
BPG3015FHB	9 ¹ / ₁₆ "	25 ¹ / ₄ "	11"	26 ⁷ / ₁₆ "	9 ⁷ / ₁₆ "	24 ⁷ / ₈ "	11 ¹ / ₁₆ "	26 ¹ / ₂ "	10 ¹ / ₄ "	25 ¹ / ₄ "	9 ¹ / ₈ "	24 ⁷ / ₈ "	10 ⁵ / ₈ "	25 ⁵ / ₈ "
BPG3612FHB	12 ¹³ / ₁₆ "	25 ¹ / ₄ "	14"	26 ⁷ / ₁₆ "	12 ⁷ / ₁₆ "	24 ⁷ / ₈ "	14 ¹ / ₁₆ "	26 ¹ / ₂ "	13 ³ / ₄ "	25 ¹ / ₄ "	12 ¹ / ₈ "	24 ⁷ / ₈ "	13 ³ / ₈ "	25 ⁵ / ₈ "
BPG3615FHB	12 ¹³ / ₁₆ "	25 ¹ / ₄ "	14"	26 ⁷ / ₁₆ "	12 ⁷ / ₁₆ "	24 ⁷ / ₈ "	14 ¹ / ₁₆ "	26 ¹ / ₂ "	13 ³ / ₄ "	25 ¹ / ₄ "	12 ¹ / ₈ "	24 ⁷ / ₈ "	13 ³ / ₈ "	25 ⁵ / ₈ "
DCPG2430	9 ⁵ / ₈ "	24 ⁵ / ₈ "	10 ¹³ / ₁₆ "	25 ¹³ / ₁₆ "	9 ¹ / ₄ "	24 ¹ / ₄ "	10 ⁵ / ₈ "	25 ⁵ / ₈ "	12 ¹ / ₄ "	24 ¹ / ₄ "	11 ¹ / ₈ "	23 ³ / ₈ "	12 ⁵ / ₈ "	24 ⁵ / ₈ "
DCPG2436	9 ⁵ / ₈ "	30 ⁵ / ₈ "	10 ¹³ / ₁₆ "	31 ¹³ / ₁₆ "	9 ¹ / ₄ "	30 ¹ / ₄ "	10 ⁵ / ₈ "	31 ⁵ / ₈ "	12 ¹ / ₄ "	30 ¹ / ₄ "	11 ¹ / ₈ "	29 ³ / ₈ "	12 ⁵ / ₈ "	30 ⁵ / ₈ "
DCPG2442	9 ⁵ / ₈ "	36 ⁵ / ₈ "	10 ¹³ / ₁₆ "	37 ¹³ / ₁₆ "	9 ¹ / ₄ "	36 ¹ / ₄ "	10 ⁵ / ₈ "	37 ⁵ / ₈ "	12 ¹ / ₄ "	36 ¹ / ₄ "	11 ¹ / ₈ "	35 ³ / ₈ "	12 ⁵ / ₈ "	36 ⁵ / ₈ "
DCPG2730	9 ⁵ / ₈ "	24 ⁵ / ₈ "	10 ¹³ / ₁₆ "	25 ¹³ / ₁₆ "	9 ¹ / ₄ "	24 ¹ / ₄ "	10 ⁵ / ₈ "	25 ⁵ / ₈ "	12 ¹ / ₄ "	24 ¹ / ₄ "	11 ¹ / ₈ "	23 ³ / ₈ "	12 ⁵ / ₈ "	24 ⁵ / ₈ "
DCPG2736	9 ⁵ / ₈ "	30 ⁵ / ₈ "	10 ¹³ / ₁₆ "	31 ¹³ / ₁₆ "	9 ¹ / ₄ "	30 ¹ / ₄ "	10 ⁵ / ₈ "	31 ⁵ / ₈ "	12 ¹ / ₄ "	30 ¹ / ₄ "	11 ¹ / ₈ "	29 ³ / ₈ "	12 ⁵ / ₈ "	30 ⁵ / ₈ "
DCPG2742	9 ⁵ / ₈ "	36 ⁵ / ₈ "	10 ¹³ / ₁₆ "	37 ¹³ / ₁₆ "	9 ¹ / ₄ "	36 ¹ / ₄ "	10 ⁵ / ₈ "	37 ⁵ / ₈ "	12 ¹ / ₄ "	36 ¹ / ₄ "	11 ¹ / ₈ "	35 ³ / ₈ "	12 ⁵ / ₈ "	36 ⁵ / ₈ "
PWPG3024B	9 ¹³ / ₁₆ "	18 ⁵ / ₈ "	11"	19 ¹³ / ₁₆ "	9 ⁷ / ₁₆ "	18 ¹ / ₄ "	11 ¹ / ₁₆ "	19 ⁷ / ₈ "	10 ¹ / ₄ "	18 ¹ / ₄ "	9 ¹ / ₈ "	17 ¹ / ₈ "	10 ⁵ / ₈ "	18 ⁵ / ₈ "
PWPG3624B	12 ¹³ / ₁₆ "	18 ⁵ / ₈ "	14"	19 ¹³ / ₁₆ "	12 ⁷ / ₁₆ "	18 ¹ / ₄ "	14 ¹ / ₁₆ "	19 ⁷ / ₈ "	13 ³ / ₄ "	18 ¹ / ₄ "	12 ¹ / ₈ "	17 ¹ / ₈ "	13 ³ / ₈ "	18 ⁵ / ₈ "
WPG1214	6 ⁵ / ₈ "	8 ⁵ / ₈ "	7 ¹³ / ₁₆ "	9 ¹³ / ₁₆ "	6 ¹ / ₄ "	8 ¹ / ₄ "	7 ⁷ / ₈ "	9 ⁷ / ₈ "	6 ¹ / ₄ "	8 ¹ / ₄ "	5 ¹ / ₈ "	7 ¹ / ₈ "	6 ⁵ / ₈ "	8 ⁵ / ₈ "
WPG1218	6 ⁵ / ₈ "	12 ⁵ / ₈ "	7 ¹³ / ₁₆ "	13 ¹³ / ₁₆ "	6 ¹ / ₄ "	12 ¹ / ₄ "	7 ⁷ / ₈ "	13 ³ / ₈ "	6 ¹ / ₄ "	12 ¹ / ₄ "	5 ¹ / ₈ "	11 ¹ / ₈ "	6 ⁵ / ₈ "	12 ⁵ / ₈ "
WPG1230	6 ⁵ / ₈ "	24 ⁵ / ₈ "	7 ¹³ / ₁₆ "	25 ¹³ / ₁₆ "	6 ¹ / ₄ "	24 ¹ / ₄ "	7 ⁷ / ₈ "	25 ⁵ / ₈ "	6 ¹ / ₄ "	24 ¹ / ₄ "	5 ¹ / ₈ "	23 ³ / ₈ "	6 ⁵ / ₈ "	24 ⁵ / ₈ "
WPG1236	6 ⁵ / ₈ "	30 ⁵ / ₈ "	7 ¹³ / ₁₆ "	31 ¹³ / ₁₆ "	6 ¹ / ₄ "	30 ¹ / ₄ "	7 ⁷ / ₈ "	31 ⁷ / ₈ "	6 ¹ / ₄ "	30 ¹ / ₄ "	5 ¹ / ₈ "	29 ³ / ₈ "	6 ⁵ / ₈ "	30 ⁵ / ₈ "
WPG1242	6 ⁵ / ₈ "	36 ⁵ / ₈ "	7 ¹³ / ₁₆ "	37 ¹³ / ₁₆ "	6 ¹ / ₄ "	36 ¹ / ₄ "	7 ⁷ / ₈ "	37 ⁵ / ₈ "	6 ¹ / ₄ "	36 ¹ / ₄ "	5 ¹ / ₈ "	35 ³ / ₈ "	6 ⁵ / ₈ "	36 ⁵ / ₈ "
WPG1514	9 ⁵ / ₈ "	8 ⁵ / ₈ "	10 ¹³ / ₁₆ "	9 ¹³ / ₁₆ "	9 ¹ / ₄ "	8 ¹ / ₄ "	10 ⁵ / ₈ "	9 ⁵ / ₈ "	9 ¹ / ₄ "	8 ¹ / ₄ "	8 ¹ / ₈ "	7 ¹ / ₈ "	9 ⁵ / ₈ "	8 ⁵ / ₈ "
WPG1518	9 ⁵ / ₈ "	12 ⁵ / ₈ "	10 ¹³ / ₁₆ "	13 ¹³ / ₁₆ "	9 ¹ / ₄ "	12 ¹ / ₄ "	10 ⁵ / ₈ "	13 ³ / ₈ "	9 ¹ / ₄ "	12 ¹ / ₄ "	8 ¹ / ₈ "	11 ¹ / ₈ "	9 ⁵ / ₈ "	12 ⁵ / ₈ "
WPG1530	9 ⁵ / ₈ "	24 ⁵ / ₈ "	10 ¹³ / ₁₆ "	25 ¹³ / ₁₆ "	9 ¹ / ₄ "	24 ¹ / ₄ "	10 ⁵ / ₈ "	25 ⁵ / ₈ "	9 ¹ / ₄ "	24 ¹ / ₄ "	8 ¹ / ₈ "	23 ³ / ₈ "	9 ⁵ / ₈ "	24 ⁵ / ₈ "
WPG1536/WPG153615	9 ⁵ / ₈ "	30 ⁵ / ₈ "	10 ¹³ / ₁₆ "	31 ¹³ / ₁₆ "	9 ¹ / ₄ "	30 ¹ / ₄ "	10 ⁵ / ₈ "	31 ⁵ / ₈ "	9 ¹ / ₄ "	30 ¹ / ₄ "	8 ¹ / ₈ "	29 ³ / ₈ "	9 ⁵ / ₈ "	30 ⁵ / ₈ "
WPG1542/WPG154215	9 ⁵ / ₈ "	36 ⁵ / ₈ "	10 ¹³ / ₁₆ "	37 ¹³ / ₁₆ "	9 ¹ / ₄ "	36 ¹ / ₄ "	10 ⁵ / ₈ "	37 ⁵ / ₈ "	9 ¹ / ₄ "	36 ¹ / ₄ "	8 ¹ / ₈ "	35 ³ / ₈ "	9 ⁵ / ₈ "	36 ⁵ / ₈ "
WPG1814	12 ⁵ / ₈ "	8 ⁵ / ₈ "	13 ¹³ / ₁₆ "	9 ¹³ / ₁₆ "	12 ¹ / ₄ "	8 ¹ / ₄ "	13 ³ / ₈ "	9 ⁵ / ₈ "	12 ¹ / ₄ "	8 ¹ / ₄ "	11 ¹ / ₈ "	7 ¹ / ₈ "	12 ⁵ / ₈ "	8 ⁵ / ₈ "
WPG1818	12 ⁵ / ₈ "	12 ⁵ / ₈ "	13 ¹³ / ₁₆ "	13 ¹³ / ₁₆ "	12 ¹ / ₄ "	12 ¹ / ₄ "	13 ³ / ₈ "	13 ³ / ₈ "	12 ¹ / ₄ "	12 ¹ / ₄ "	11 ¹ / ₈ "	11 ¹ / ₈ "	12 ⁵ / ₈ "	12 ⁵ / ₈ "
WPG1830	12 ⁵ / ₈ "	24 ⁵ / ₈ "	13 ¹³ / ₁₆ "	25 ¹³ / ₁₆ "	12 ¹ / ₄ "	24 ¹ / ₄ "	13 ³ / ₈ "	25 ⁵ / ₈ "	12 ¹ / ₄ "	24 ¹ / ₄ "	11 ¹ / ₈ "	23 ³ / ₈ "	12 ⁵ / ₈ "	24 ⁵ / ₈ "
WPG1836/WPG183615	12 ⁵ / ₈ "	30 ⁵ / ₈ "	13 ¹³ / ₁₆ "	31 ¹³ / ₁₆ "	12 ¹ / ₄ "	30 ¹ / ₄ "	13 ³ / ₈ "	31 ⁵ / ₈ "	12 ¹ / ₄ "	30 ¹ / ₄ "	11 ¹ / ₈ "	29 ³ / ₈ "	12 ⁵ / ₈ "	30 ⁵ / ₈ "
WPG1842/WPG184215	12 ⁵ / ₈ "	36 ⁵ / ₈ "	13 ¹³ / ₁₆ "	37 ¹³ / ₁₆ "	12 ¹ / ₄ "	36 ¹ / ₄ "	13 ³ / ₈ "	37 ⁵ / ₈ "	12 ¹ / ₄ "	36 ¹ / ₄ "	11 ¹ / ₈ "	35 ³ / ₈ "	12 ⁵ / ₈ "	36 ⁵ / ₈ "
WPG2114	15 ⁵ / ₈ "	8 ⁵ / ₈ "	16 ¹³ / ₁₆ "	9 ¹³ / ₁₆ "	15 ¹ / ₄ "	8 ¹ / ₄ "	16 ⁷ / ₈ "	9 ⁵ / ₈ "	15 ¹ / ₄ "	8 ¹ / ₄ "	14 ¹ / ₈ "	7 ¹ / ₈ "	15 ⁵ / ₈ "	8 ⁵ / ₈ "
WPG2118	15 ⁵ / ₈ "	12 ⁵ / ₈ "	16 ¹³ / ₁₆ "	13 ¹³ / ₁₆ "	15 ¹ / ₄ "	12 ¹ / ₄ "	16 ⁷ / ₈ "	13 ³ / ₈ "	15 ¹ / ₄ "	12 ¹ / ₄ "	14 ¹ / ₈ "	11 ¹ / ₈ "	15 ⁵ / ₈ "	12 ⁵ / ₈ "
WPG2130/WPG213016	15 ⁵ / ₈ "	24 ⁵ / ₈ "	16 ¹³ / ₁₆ "	25 ¹³ / ₁₆ "	15 ¹ / ₄ "	24 ¹ / ₄ "	16 ⁷ / ₈ "	25 ⁵ / ₈ "	15 ¹ / ₄ "	24 ¹ / ₄ "	14 ¹ / ₈ "	23 ³ / ₈ "	15 ⁵ / ₈ "	24 ⁵ / ₈ "
WPG2136/WPG213615	15 ⁵ / ₈ "	30 ⁵ / ₈ "	16 ¹³ / ₁₆ "	31 ¹³ / ₁₆ "	15 ¹ / ₄ "	30 ¹ / ₄ "	16 ⁷ / ₈ "	31 ⁷ / ₈ "	15 ¹ / ₄ "	30 ¹ / ₄ "	14 ¹ / ₈ "	29 ³ / ₈ "	15 ⁵ / ₈ "	30 ⁵ / ₈ "
WPG2142/WPG214215	15 ⁵ / ₈ "	36 ⁵ / ₈ "	16 ¹³ / ₁₆ "	37 ¹³ / ₁₆ "	15 ¹ / ₄ "	36 ¹ / ₄ "	16 ⁷ / ₈ "	37 ⁵ / ₈ "	15 ¹ / ₄ "	36 ¹ / ₄ "	14 ¹ / ₈ "	35 ³ / ₈ "	15 ⁵ / ₈ "	36 ⁵ / ₈ "
WPG2414	18 ⁵ / ₈ "	8 ⁵ / ₈ "	19 ¹³ / ₁₆ "	9 ¹³ / ₁₆ "	18 ¹ / ₄ "	8 ¹ / ₄ "	19 ⁷ / ₈ "	9 ⁵ / ₈ "	18 ¹ / ₄ "	8 ¹ / ₄ "	17 ¹ / ₈ "	7 ¹ / ₈ "	18 ⁵ / ₈ "	8 ⁵ / ₈ "
WPG2418	18 ⁵ / ₈ "	12 ⁵ / ₈ "	19 ¹³ / ₁₆ "	13 ¹³ / ₁₆ "	18 ¹ / ₄ "	12 ¹ / ₄ "	19 ⁷ / ₈ "	13 ³ / ₈ "	18 ¹ / ₄ "	12 ¹ / ₄ "	17 ¹ / ₈ "	11 ¹ / ₈ "	18 ⁵ / ₈ "	12 ⁵ / ₈ "
WPG2424	18 ⁵ / ₈ "	18 ⁵ / ₈ "	19 ¹³ / ₁₆ "	19 ¹³ / ₁₆ "	18 ¹ / ₄ "	18 ¹ / ₄ "	19 ⁷ / ₈ "	19 ⁷ / ₈ "	18 ¹ / ₄ "	18 ¹ / ₄ "	17 ¹ / ₈ "	17 ¹ / ₈ "	18 ⁵ / ₈ "	18 ⁵ / ₈ "
WPG2430/WPG243015	18 ⁵ / ₈ "	24 ⁵ / ₈ "	19 ¹³ / ₁₆ "	25 ¹³ / ₁₆ "	18 ¹ / ₄ "	24 ¹ / ₄ "	19 ⁷ / ₈ "	25 ⁵ / ₈ "	18 ¹ / ₄ "	24 ¹ / ₄ "	17 ¹ / ₈ "	23 ³ / ₈ "	18 ⁵ / ₈ "	24 ⁵ / ₈ "
WPG2436/WPG2436														

Glass Size Chart for Wall Prepped for Glass Cabinets

	Briarcliff II Dryden Durham Eastland Overton Wentworth		Brellin		Korbett		Harrison Winstead		Benton Saybrooke		Grayson Landen		Ayden Avalon Oakland Pioneer Radford Sinclair Westbury	
	Width	Height	Width	Height	Width	Height	Width	Height	Width	Height	Width	Height	Width	Height
RECOMMENDED GLASS SIZES														
WPG3612B	12 ¹³ / ₁₆ "	6 ⁵ / ₈ "	14"	7 ¹³ / ₁₆ "	12 ⁷ / ₁₆ "	8 ¹ / ₄ "	14 ¹ / ₁₆ "	7 ⁷ / ₈ "	13 ¹ / ₄ "	8 ¹ / ₄ "	12 ¹ / ₈ "	5 ¹ / ₈ "	13 ⁵ / ₈ "	6 ⁵ / ₈ "
WPG3614B	12 ¹³ / ₁₆ "	8 ⁵ / ₈ "	14"	9 ¹³ / ₁₆ "	12 ⁷ / ₁₆ "	10 ¹ / ₄ "	14 ¹ / ₁₆ "	9 ⁷ / ₈ "	13 ¹ / ₄ "	10 ¹ / ₄ "	12 ¹ / ₈ "	7 ¹ / ₈ "	13 ⁵ / ₈ "	8 ⁵ / ₈ "
WPG3618B	12 ¹³ / ₁₆ "	12 ⁵ / ₈ "	14"	13 ¹³ / ₁₆ "	12 ⁷ / ₁₆ "	12 ¹ / ₄ "	14 ¹ / ₁₆ "	13 ³ / ₈ "	13 ¹ / ₄ "	12 ¹ / ₄ "	12 ¹ / ₈ "	11 ¹ / ₈ "	13 ⁵ / ₈ "	12 ⁵ / ₈ "
WPG3621B/WPG362115B	12 ¹³ / ₁₆ "	15 ⁵ / ₈ "	14"	16 ¹³ / ₁₆ "	12 ⁷ / ₁₆ "	15 ¹ / ₄ "	14 ¹ / ₁₆ "	16 ⁷ / ₈ "	13 ¹ / ₄ "	15 ¹ / ₄ "	12 ¹ / ₈ "	14 ¹ / ₈ "	13 ⁵ / ₈ "	15 ⁵ / ₈ "
WPG3624B/WPG362415B	12 ¹³ / ₁₆ "	18 ⁵ / ₈ "	14"	19 ¹³ / ₁₆ "	12 ⁷ / ₁₆ "	18 ¹ / ₄ "	14 ¹ / ₁₆ "	19 ⁷ / ₈ "	13 ¹ / ₄ "	18 ¹ / ₄ "	12 ¹ / ₈ "	17 ¹ / ₈ "	13 ⁵ / ₈ "	18 ⁵ / ₈ "
WPG3630B/WPG363015B	12 ¹³ / ₁₆ "	24 ⁵ / ₈ "	14"	25 ¹³ / ₁₆ "	12 ⁷ / ₁₆ "	24 ¹ / ₄ "	14 ¹ / ₁₆ "	25 ⁷ / ₈ "	13 ¹ / ₄ "	24 ¹ / ₄ "	12 ¹ / ₈ "	23 ¹ / ₈ "	13 ⁵ / ₈ "	24 ⁵ / ₈ "
WPG3636B/WPG363615B	12 ¹³ / ₁₆ "	30 ⁵ / ₈ "	14"	31 ¹³ / ₁₆ "	12 ⁷ / ₁₆ "	30 ¹ / ₄ "	14 ¹ / ₁₆ "	31 ⁷ / ₈ "	13 ¹ / ₄ "	30 ¹ / ₄ "	12 ¹ / ₈ "	29 ¹ / ₈ "	13 ⁵ / ₈ "	30 ⁵ / ₈ "
WPG3642B/WPG364215B	12 ¹³ / ₁₆ "	36 ⁵ / ₈ "	14"	37 ¹³ / ₁₆ "	12 ⁷ / ₁₆ "	36 ¹ / ₄ "	14 ¹ / ₁₆ "	37 ⁷ / ₈ "	13 ¹ / ₄ "	36 ¹ / ₄ "	12 ¹ / ₈ "	35 ¹ / ₈ "	13 ⁵ / ₈ "	36 ⁵ / ₈ "
WPG3912	14 ¹ / ₈ "	6 ⁵ / ₈ "	15 ⁵ / ₁₆ "	7 ¹³ / ₁₆ "	•	•	15 ⁵ / ₈ "	7 ⁷ / ₈ "	13 ³ / ₄ "	8 ¹ / ₄ "	12 ⁵ / ₈ "	5 ¹ / ₈ "	14 ¹ / ₈ "	6 ⁵ / ₈ "
WPG3914	14 ¹ / ₈ "	8 ⁵ / ₈ "	15 ⁵ / ₁₆ "	9 ¹³ / ₁₆ "	13 ³ / ₄ "	10 ¹ / ₄ "	15 ⁵ / ₈ "	9 ⁷ / ₈ "	13 ³ / ₄ "	10 ¹ / ₄ "	12 ⁵ / ₈ "	7 ¹ / ₈ "	14 ¹ / ₈ "	8 ⁵ / ₈ "
WPG3918	14 ¹ / ₈ "	12 ⁵ / ₈ "	15 ⁵ / ₁₆ "	13 ¹³ / ₁₆ "	13 ³ / ₄ "	12 ¹ / ₄ "	15 ⁵ / ₈ "	13 ³ / ₈ "	13 ³ / ₄ "	12 ¹ / ₄ "	12 ⁵ / ₈ "	11 ¹ / ₈ "	14 ¹ / ₈ "	12 ⁵ / ₈ "
WPG3930/WPG393015	14 ¹ / ₈ "	24 ⁵ / ₈ "	15 ⁵ / ₁₆ "	25 ¹³ / ₁₆ "	13 ³ / ₄ "	24 ¹ / ₄ "	15 ⁵ / ₈ "	25 ⁷ / ₈ "	13 ³ / ₄ "	24 ¹ / ₄ "	12 ⁵ / ₈ "	23 ¹ / ₈ "	14 ¹ / ₈ "	24 ⁵ / ₈ "
WPG4212 (MIDDLE)	9 ⁵ / ₈ "	6 ⁵ / ₈ "	10 ¹³ / ₁₆ "	7 ¹³ / ₁₆ "	9 ¹ / ₄ "	8 ¹ / ₄ "	10 ⁷ / ₈ "	7 ⁷ / ₈ "	9 ¹ / ₄ "	8 ¹ / ₄ "	8 ¹ / ₈ "	5 ¹ / ₈ "	9 ⁵ / ₈ "	6 ⁵ / ₈ "
WPG4212 (OUTER)	8 ¹ / ₈ "	6 ⁵ / ₈ "	8"	7 ¹³ / ₁₆ "	7 ³ / ₄ "	8 ¹ / ₄ "	9 ³ / ₈ "	7 ⁷ / ₈ "	7 ³ / ₄ "	8 ¹ / ₄ "	6 ⁵ / ₈ "	5 ¹ / ₈ "	8 ¹ / ₈ "	6 ⁵ / ₈ "
WPG4214 (MIDDLE)	9 ⁵ / ₈ "	8 ⁵ / ₈ "	10 ¹³ / ₁₆ "	9 ¹³ / ₁₆ "	9 ¹ / ₄ "	10 ¹ / ₄ "	10 ⁷ / ₈ "	9 ⁷ / ₈ "	9 ¹ / ₄ "	10 ¹ / ₄ "	8 ¹ / ₈ "	7 ¹ / ₈ "	9 ⁵ / ₈ "	8 ⁵ / ₈ "
WPG4214 (OUTER)	8 ¹ / ₈ "	8 ⁵ / ₈ "	8"	9 ¹³ / ₁₆ "	7 ³ / ₄ "	10 ¹ / ₄ "	9 ³ / ₈ "	9 ⁷ / ₈ "	7 ³ / ₄ "	10 ¹ / ₄ "	6 ⁵ / ₈ "	7 ¹ / ₈ "	8 ¹ / ₈ "	8 ⁵ / ₈ "
WPG4218	15 ⁵ / ₈ "	12 ⁵ / ₈ "	16 ¹³ / ₁₆ "	13 ¹³ / ₁₆ "	15 ¹ / ₄ "	12 ¹ / ₄ "	16 ⁷ / ₈ "	13 ³ / ₈ "	15 ¹ / ₄ "	12 ¹ / ₄ "	14 ¹ / ₈ "	11 ¹ / ₈ "	15 ⁵ / ₈ "	12 ⁵ / ₈ "
WPG4230/WPG423015	15 ⁵ / ₈ "	24 ⁵ / ₈ "	16 ¹³ / ₁₆ "	25 ¹³ / ₁₆ "	15 ¹ / ₄ "	24 ¹ / ₄ "	16 ⁷ / ₈ "	25 ⁷ / ₈ "	15 ¹ / ₄ "	24 ¹ / ₄ "	14 ¹ / ₈ "	23 ¹ / ₈ "	15 ⁵ / ₈ "	24 ⁵ / ₈ "
WPG4530/WPG453015	17 ¹ / ₈ "	24 ⁵ / ₈ "	18 ⁵ / ₁₆ "	25 ¹³ / ₁₆ "	16 ³ / ₄ "	24 ¹ / ₄ "	18 ³ / ₈ "	25 ⁷ / ₈ "	16 ³ / ₄ "	24 ¹ / ₄ "	15 ⁵ / ₈ "	23 ¹ / ₈ "	17 ¹ / ₈ "	24 ⁵ / ₈ "
WPG4812 (MIDDLE)	9 ⁵ / ₈ "	6 ⁵ / ₈ "	10 ¹³ / ₁₆ "	7 ¹³ / ₁₆ "	9 ¹ / ₄ "	8 ¹ / ₄ "	10 ⁷ / ₈ "	7 ⁷ / ₈ "	9 ¹ / ₄ "	8 ¹ / ₄ "	8 ¹ / ₈ "	5 ¹ / ₈ "	9 ⁵ / ₈ "	6 ⁵ / ₈ "
WPG4812 (OUTER)	11 ¹ / ₈ "	6 ⁵ / ₈ "	12 ⁵ / ₁₆ "	7 ¹³ / ₁₆ "	11 ³ / ₄ "	8 ¹ / ₄ "	12 ³ / ₈ "	7 ⁷ / ₈ "	11 ³ / ₄ "	8 ¹ / ₄ "	9 ⁵ / ₈ "	5 ¹ / ₈ "	11 ¹ / ₈ "	6 ⁵ / ₈ "
WPG4814 (MIDDLE)	9 ⁵ / ₈ "	8 ⁵ / ₈ "	10 ¹³ / ₁₆ "	9 ¹³ / ₁₆ "	9 ¹ / ₄ "	10 ¹ / ₄ "	10 ⁷ / ₈ "	9 ⁷ / ₈ "	9 ¹ / ₄ "	10 ¹ / ₄ "	8 ¹ / ₈ "	7 ¹ / ₈ "	9 ⁵ / ₈ "	8 ⁵ / ₈ "
WPG4814 (OUTER)	11 ¹ / ₈ "	8 ⁵ / ₈ "	12 ⁵ / ₁₆ "	9 ¹³ / ₁₆ "	11 ³ / ₄ "	10 ¹ / ₄ "	12 ³ / ₈ "	9 ⁷ / ₈ "	11 ³ / ₄ "	10 ¹ / ₄ "	9 ⁵ / ₈ "	7 ¹ / ₈ "	11 ¹ / ₈ "	8 ⁵ / ₈ "
WPG4830	18 ⁵ / ₈ "	24 ⁵ / ₈ "	19 ¹³ / ₁₆ "	25 ¹³ / ₁₆ "	18 ¹ / ₄ "	24 ¹ / ₄ "	19 ⁷ / ₈ "	25 ⁷ / ₈ "	18 ¹ / ₄ "	24 ¹ / ₄ "	17 ¹ / ₈ "	23 ¹ / ₈ "	18 ⁵ / ₈ "	24 ⁵ / ₈ "

5-Piece Drawer Front Dimensions

5-PIECE STYLE NAME	DRAWER FRONT WIDTH	DRAWER FRONT HEIGHT	FLAT PANEL WIDTH	FLAT PANEL HEIGHT
Ayden 5-Piece	9 ⁷ / ₈ "	5 ¹ / ₈ "	5 ⁷ / ₈ "	1 ¹ / ₈ "
Benton 5-Piece	9 ⁷ / ₈ "	5 ¹ / ₈ "	5 ⁷ / ₈ "	1 ¹ / ₈ "
Briarcliff II	11 ¹ / ₂ "	5 ³ / ₄ "	6"	1 ¹ / ₈ "
Dryden 5-Piece	11 ¹ / ₂ "	5 ³ / ₄ "	6"	1 ¹ / ₈ "
Durham	11 ¹ / ₂ "	5 ³ / ₄ "	7 ¹ / ₂ "	1 ³ / ₄ "
Eastland 5-Piece	11 ¹ / ₂ "	5 ³ / ₄ "	6"	1 ¹ / ₈ "
Grayson 5-Piece	9 ⁷ / ₈ "	5 ¹ / ₈ "	5 ⁷ / ₈ "	1 ¹ / ₈ "
Harrison 5-Piece	11 ¹ / ₂ "	5 ³ / ₄ "	7 ¹ / ₁₆ "	1 ⁵ / ₁₆ "
Korbett 5-Piece	11 ¹ / ₂ "	5 ³ / ₄ "	5 ¹ / ₂ "	1 ⁵ / ₁₆ "
Landen 5-Piece	9 ⁷ / ₈ "	5 ¹ / ₈ "	5 ⁷ / ₈ "	1 ¹ / ₈ "
Nantucket	11 ¹ / ₂ "	5 ³ / ₄ "	4 ²⁹ / ₃₂ "	1 ³ / ₄ "
Overton	11 ¹ / ₂ "	5 ³ / ₄ "	7 ¹ / ₂ "	1 ³ / ₄ "
Radford 5-Piece	9 ⁷ / ₈ "	5 ¹ / ₈ "	5 ⁷ / ₈ "	1 ¹ / ₈ "
Saybrooke 5-Piece	9 ⁷ / ₈ "	5 ¹ / ₈ "	5 ⁷ / ₈ "	1 ¹ / ₈ "
Wentworth	11 ¹ / ₂ "	5 ³ / ₄ "	7 ¹ / ₂ "	1 ³ / ₄ "
Winstead 5-Piece	11 ¹ / ₂ "	5 ³ / ₄ "	7 ¹ / ₁₆ "	1 ⁵ / ₁₆ "

Drawer Front sizes are representative of a 12" wide base cabinet.

Trim Items with Rustic Characteristics

Use Rustic Common Style Numbers to order items with Rustic Characteristics.
For all other trim items, use Maple Common Style Numbers (see page 26).

Product Code	Description	Page #
BBCPO6	Base Box Column Pull-Out Cabinet	87
MCROWN8	Moulding Crown	142
MICROWN8	Moulding Insert Crown	142
MFOLCR8	Moulding Full Overlay Crown	142
MTCROWN8	Moulding Tall Crown	142
MSHKRCROWN8	Moulding Shaker Crown	142
MBS8	Moulding Base Shoe	146
FBC3X3	Filler - Base Corner	147
F3_ _ & F6_ _	Filler - Base & Tall Straight	147
V_ _ _RA & V_ _ _ ST	Valance - Arch & Straight	153
PDWP	Dishwasher Front Panel	154
PEPR335 **	Aristex™ End Panel with 3" Stile	154
PEPRPLY_ _35 *	Plywood End Panel with 1 ¹ / ₂ " or 3" Stile	154
PREF23_ _	Plywood Refrigerator End Panel	154
PREPRP_ _ _ _ *	Plywood Refrigerator End Panel with 1 ¹ / ₂ " Stile	154
PREPR33096	Veneer Furniture Board Refrigerator End Panel with 3" Stile	154
PP9635	Stock Panel	155
P48_ _	Stock Panel	155
EPV_ _ _ _	Veneer End Panel	156

** Rustic characteristics on PEPR335 Filler only.

* Rustic characteristics on PEPRPLY1.535, PREPRP1.584, and PREPRP1.596 panels only.

Warped Door Policy

Aristokraft cabinetry is constructed to strict specifications, including the moisture content present in wood. When the moisture content is maintained at a constant level, Aristokraft is able to minimize the amount of expansion and contraction associated with natural wood. When a great amount of expansion and contraction occur, the result can be a warped door. By strictly controlling the amount of humidity present during manufacturing, Aristokraft is helping to ensure you receive a quality product.

Because wood is a natural product, each piece of wood exhibits its own unique color and grain variations. These differences give wood its genuine beauty. The wood's natural properties also determine how each individual piece will react to changing weather conditions. Therefore, eliminating warped doors is virtually impossible.

If you feel that you have a warped door, Aristokraft requires that you perform initial testing to determine the extent of the problem.

1. Remove the door from the cabinet and remove all decorative surface knobs or pulls and hinges.
2. Place the door on a completely flat surface, as determined by using a level, and alternately press on the opposite corners to observe if the door "rocks" or pulls away from the flat surface.
3. If you observe a gap between the door and flat surface, measure the distance to determine the amount of warpage.
 - A door must be warped at least 1/4" before it can be considered for replacement. When ordering a replacement by using Aristokraft Part Replacement Order Form, be sure to fill in the reason for proper replacement code as "06".
 - If the door is warped less than 1/4", we recommend you allow a complete heating and cooling cycle (summer to winter) to allow the door to reach moisture equilibrium. Adding magnetic catches or roller catches will often correct minor problems.
4. If the door does not pull away from the flat surface, it is not warped. Most likely, there is a problem with the cabinet installation. When cabinets are not properly installed in a level or plumb position, they will become racked and will cause the door to appear warped. To check for a racked cabinet, place a level on one end rail. The bubble in the level will appear centered if the cabinet was properly installed in a level position. Now, place the level on the other end rail. Again, if the bubble appears centered the cabinet is properly installed in a level position. Any variations in the location of the bubble will indicate the cabinet was not properly installed. (A plumb bob will reveal the same information.)

Another proper installation check is to place the level in the top, and then bottom of the installed cabinet's face frame. Identify the bubble's position in both, top and bottom, locations of the face frame. The bubble's position will indicate if the cabinet was not properly installed.

Cabinet Care Suggestions

Cleaning Tip: Never use a dishcloth to clean or dry cabinet exteriors or interiors. Remnants of detergent or grease may be contained within the dishcloth.

Interiors: Aristokraft cabinet interiors are surfaced with Aristex™, a quality laminate material that resists scuffs, marks, and most common household spills.

1. To clean the interior surface, simply wipe with a damp cloth or sponge, then dry.
2. To remove food residue or grease, use the suds from any common dishwashing liquid and a damp cloth to wipe clean. Dry thoroughly.

CAUTION: If a spill occurs, it is important to clean up the spill and dry the surface immediately. A spill left unattended will soak through the Aristex™ and cause damage.

Exteriors — Wood Finish: Aristokraft wood exteriors are manufactured with a quality finish that protects the wood and brings out its full beauty. To maintain your cabinets' appearance, Aristokraft recommends cleaning them at least once a month.

1. Simply wipe the surface of your cabinets with a clean damp cloth, then dry.
2. To remove general soil or grease, use the suds from any common dishwashing liquid and a damp cloth to wipe clean. Dry thoroughly.
3. Excess moisture can damage any cabinet finish; areas near the sink, range, dishwasher, oven and baseboards are the most susceptible. Keep these surfaces dry.
4. Because Aristokraft uses a quality varnish on the finish, waxing your cabinets is not necessary. If waxing is preferred, use any furniture polish or lemon oil recommended for fine furniture. Be sure to completely wipe off the excess wax to avoid build-up.

CAUTION: Avoid using cleaners that contain bleach, ammonia or state on the label they have any type of abrasives. These cleaners can cause damage to your cabinet finish.

Exteriors — PureStyle™/Thermofoil: Some Aristokraft styles use doors and drawer fronts with a laminate or thermofoil finish. To clean this type of finish, Aristokraft recommends the same procedure described for wood exteriors.

Discontinued Product Policy

- A minimum of 60 days notice will be given to customers announcing the discontinuation of a product.
- Product will no longer be available to order after the discontinuation date. Only warranty orders will be considered. With warranty orders, Aristokraft will have the option to repair or replace a customer's defective product with the same discontinued product they originally purchased or with a current product that is similar in appearance.

Freight Policy

- If an entire order is no charge, Aristokraft will pay for standard ground freight.
- If an order contains a chargeable item, the cost of freight will be charged to the customer's invoice.
- If a customer requests an upgrade to a parcel shipment method, the customer will be charged the entire freight charge.

Returned Goods Policy

- All cabinets are manufactured according to the individual order and cannot be changed, cancelled, or returned once order has been scheduled.

Transportation Claims

- Please inspect merchandise at time of signing freight bill, and have the transportation company note any damage incurred in transit.

Disclosure

- Prices and specifications are subject to change without notice.

Five Year Limited Warranty on Cabinets. Aristokraft warrants to original consumer purchasers for a period of five years from the original date of purchase that all other components of Aristokraft cabinetry shall be free from defects in material and workmanship under normal use.

Lifetime Limited Warranty on Drawer Guides and Hinges. Aristokraft warrants to original consumer purchasers for as long as they own their homes that the drawer box, drawer guides and hinges used in the manufacture of Aristokraft cabinetry products shall be free from defects in material and workmanship under normal use.

These warranties are only applicable to products used in residential applications within the United States and is not transferable to subsequent owners.

Should defects in material or workmanship exist during the applicable warranty period in any Aristokraft product, Aristokraft will elect at its discretion to either repair or replace the defective material or component free of charge. This warranty covers only parts and materials of the products supplied by Aristokraft. Not covered under this warranty are counter tops, appliances, plumbing fixtures, etc. or the costs, including labor, to remove and reinstall materials and related components such as fittings, appliances, etc.

This warranty shall become void if the cabinets are in any way modified, improperly installed or damaged prior to or during the installation. This also disclaims products utilized in any application other than the standard. Furthermore, this warranty will not apply to cabinets damaged by misuse, neglect, abuse, acts of God, exposure to moisture, exposure to extreme temperatures or the effects of normal wear and tear.

Natural woods may vary in color, characteristics and exhibit subtle changes as they age. Sunlight, smoke, household cleaners and other environmental conditions may also affect the color match over time. These variations are considered to be the nature of the material in relation to their environmental exposure and are not covered under this warranty.

Aristokraft reserves the right to alter design, specifications and material without obligation to make similar changes to products previously manufactured.

The repair(s) or replacement(s) are contingent upon the current product offerings of styles and construction options within the Aristokraft product at the time of the warranty claim. If a warranty claim is filed after an Aristokraft product becomes obsolete, Aristokraft reserves the right to honor the warranty in one of the following fashions:

- 1) To replace the affected component with a new component of the same style.
- 2) To replace the affected component and any other component(s) in the residential application to achieve a uniform appearance with a similar and comparable product style of the originally purchased style.

If components are replaced, Aristokraft cannot guarantee that the finish of these replacements will exactly match the finish and appearance of the components in the residential application. This is due to the changes that occur during the woods' natural aging process, affecting its color and grain.

THIS WARRANTY IS THE EXCLUSIVE WARRANTY OF ARISTOKRAFT AND IS IN LIEU OF AND ARISTOKRAFT DISCLAIMS ALL OTHER WARRANTIES, EXPRESSED OR IMPLIED, INCLUDING THE IMPLIED WARRANTIES OF MERCHANTABILITY AND FITNESS FOR A PARTICULAR PURPOSE.

This warranty gives you specific legal rights and you may have other rights, which vary from state to state. Some states do not allow the exclusion or limitation of incidental or consequential damages, so the above limitations or exclusions may not apply to you.

To obtain replacement(s) under Aristokraft's Five Year and Lifetime Limited warranties, first contact your authorized Aristokraft Cabinetry dealer or distributor, who will arrange for inspection of the cabinet. A dated sales receipt as proof of purchase is required to obtain benefits from this warranty.

If you have difficulty obtaining assistance, please write to:

Aristokraft Cabinetry
One MasterBrand Cabinets Drive
P.O. Box 420
Jasper, IN 47547-0420
Phone: (812) 482-2527 or Fax: (812) 634-2838

Aristokraft Cabinetry is a subsidiary of MasterBrand Cabinets, Inc.

U.P.S. and Parcel Post address:

Aristokraft Cabinetry
One MasterBrand Cabinets Drive
Jasper, Indiana 47547-0420
Phone: (812) 482-2527
Fax: (812) 634-2838

Aristokraft[®]
CABINETRY



Kitchen Cabinet Manufacturers Association
Environmental Stewardship Program
All products impact the environment.
For ESP program criteria, visit greencabinetsource.org.

Aristokraft[®] Cabinetry is a certified brand in the Kitchen Cabinet Manufacturers Association (KCMA) Environmental Stewardship Program. The program recognizes companies that demonstrate an ongoing commitment to environmental practices and sustainability.

With Aristokraft, you have a reliable partner committed to delivering solutions and building value. Home after home. Time after time. With Aristokraft, confidence is built in.

Product photography and illustration have been reproduced as accurately as printing technologies permit. To ensure highest satisfaction, we strongly recommend you view an actual sample for best color wood grain and finish representation.

Styles, product availability and construction may vary slightly from those shown in this catalog due to material availability and/or design evolution. Specifications are subject to change without notice. Check One Touch for updates. Our customer service is available if your design requires verification of product availability and specifications.

www.aristokraft.com

© 2016 MasterBrand Cabinets