

Scribe Moulding

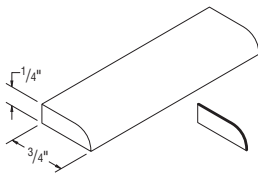

MSW8
PSMSW8

Outside Corner Moulding – 90° and 135°

DESIGN SOLUTIONS

- Use to create a finished look on ends of cabinet runs.

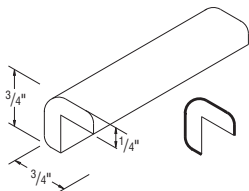

MOCW8

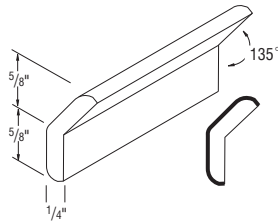

MOC135-8

Triple Bead Moulding

DESIGN SOLUTIONS

- Can be used with Inset Crown Moulding.

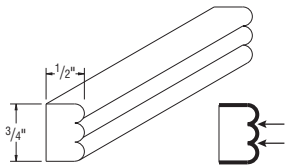

MTBEAD8
PSMTBEAD8

Trim Moulding

DESIGN SOLUTIONS

- Can be used to hide seams in stacked cabinet applications.

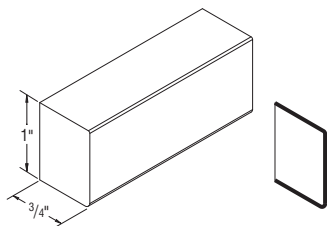

MTW8
PSMTW8

Finished edges indicated by bold lines on side view drawings.
Glazed edges indicated by arrows on side view drawings.

NOTES ✓

► MSHKRCROWN8 available in maple finishes only.

DESIGN SOLUTIONS

- For Moulding Solutions, see pages 36 & 37.
- Remember to order extra Mouldings when working with mitered corners.
- MICROWN8 and PSMICROWN8 are designed for inserts (i.e. dentil, rope, triple bead.)
- At minimum, leave a 3" reveal at the end of a run to allow Moulding and countertop ample clearance to return back to the wall.



Crown Moulding

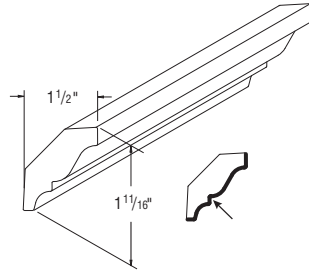

MCROWN8 (1 - 8' pc)
PSMICROWN8 (1 - 8' pc)

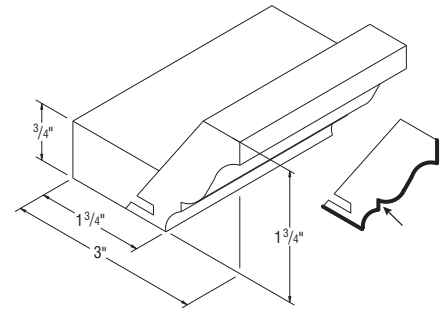

Full Overlay
MFOLCR8 (1 - 8' pc)
PSMFOLCR8 (1 - 8' pc)

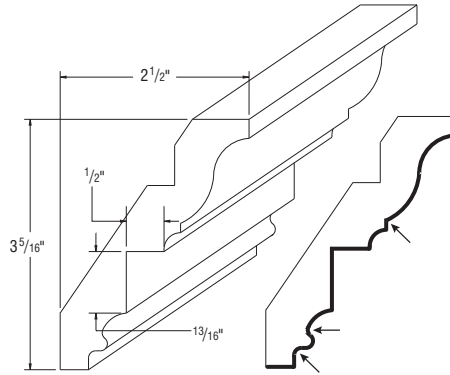

Insert
MICROWN8 (1 - 8' pc)
PSMICROWN8 (1 - 8' pc)

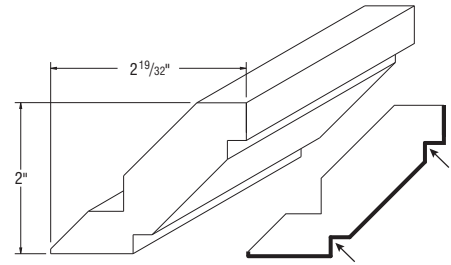

Shaker
MSHKRCROWN8 (1 - 8' pc)

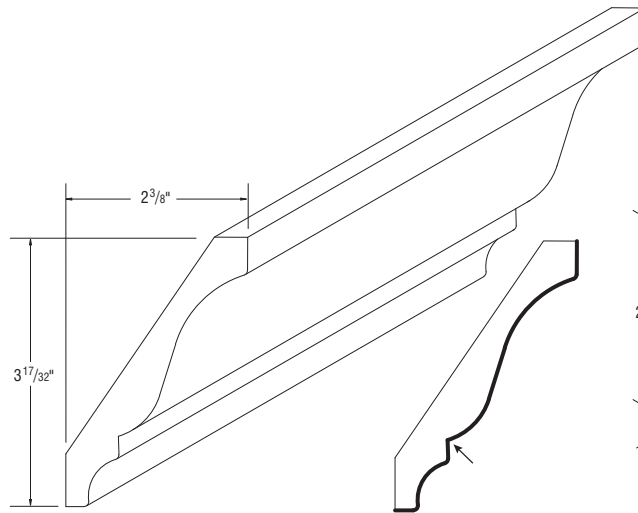

Tall
MTCROWN8 (1 - 8' pc)
PSMTROWN8 (1 - 8' pc)

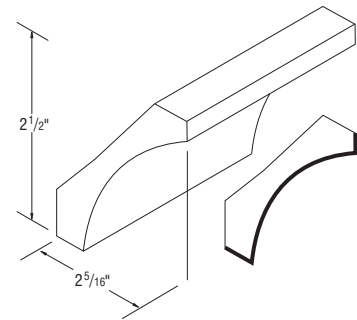

Small Cove
MSMCOVECR8 (1 - 8' pc)

Finished edges indicated by bold lines on side view drawings.
Glazed edges indicated by arrows on side view drawings.

Starter Moulding

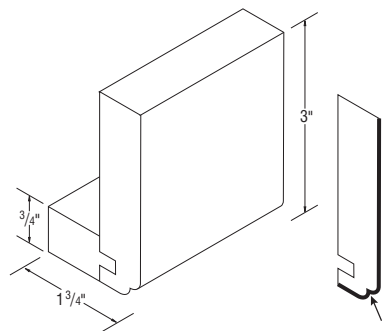

MSTR8 (1 - 8' pc)

NOTES ✓

- ▶ Top-mount installation only (cleat is attached).

DESIGN SOLUTIONS

- ▶ MSTR8 is for use with stacked moulding designs for ease of installation of top mouldings.



Soffit Filler Mouldings

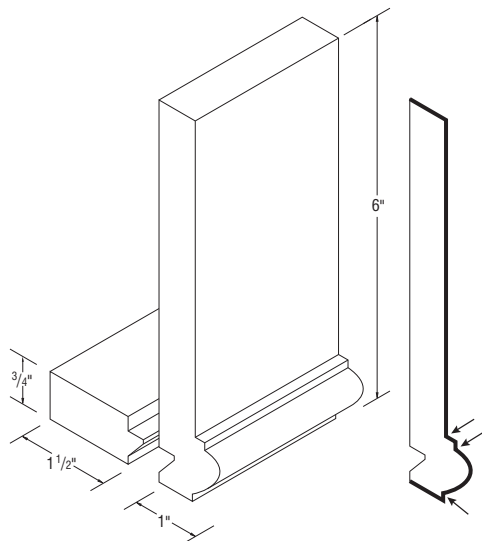

MSFM8 (1 - 8' pc)

NOTES ✓

- ▶ Cleat shipped unattached, can be MSFM8 (1 - 8' pc) top or face mounted.

DESIGN SOLUTIONS

- ▶ MSFM8 is for use with stacked moulding designs for ease of installation.



Counter Top Moulding

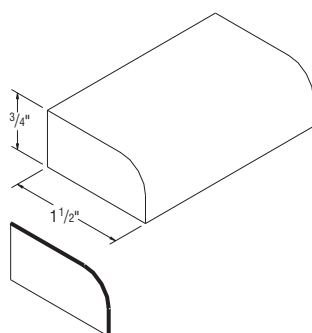

MCTR8 (1 - 8' pc)

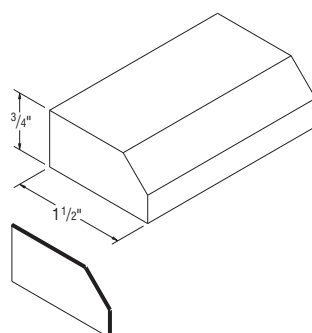

MCTB8 (1 - 8' pc)

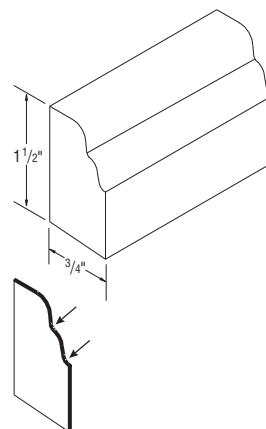

MCTOG8 (1 - 8' pc)

DESIGN SOLUTIONS

- ▶ MCTB8 can be flipped upside-down and used as top trim.



Finished edges indicated by bold lines on side view drawings.
Glazed edges indicated by arrows on side view drawings.



Cove Moulding

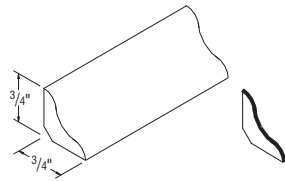

MCV8 (1 - 8' pc)



Quarter Round Moulding

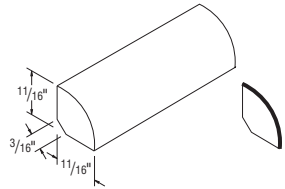

MQR8 (1 - 8' pc)
PSMQR8 (1 - 8' pc)



Batten Moulding

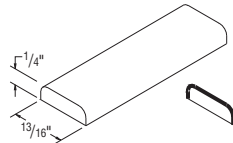

MBAT8 (1 - 8' pc)



Traditional Soffit Trim Moulding

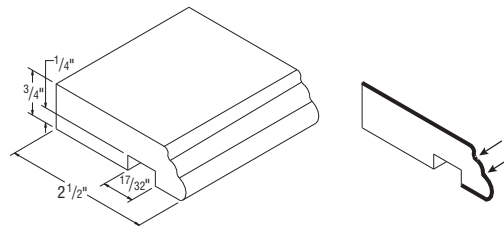

MTST8 (1 - 8' pc)
PSMTST8 (1 - 8' pc)

Finished edges indicated by bold lines on side view drawings.
Glazed edges indicated by arrows on side view drawings.

Traditional Cap Moulding

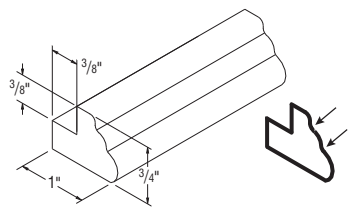

MTCAP8 (1 - 8' pc)
PSMTCAP8 (1 - 8' pc)

DESIGN SOLUTIONS

- ▶ MTCAP8 and PSMTCAP8 can be flipped upside-down and used as a base piece for a stacked top trim.



Tall Light Rail Moulding

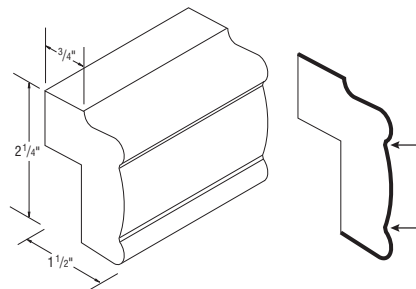

MTLR8 (1 - 8' pc)
PSMTLR8 (1 - 8' pc)



Light Rail Moulding

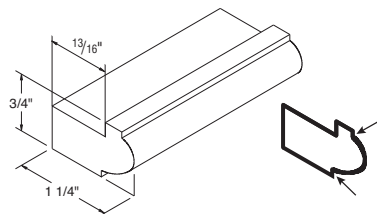

MLR8 (1 - 8' pc)

NOTES ✓

- ▶ Designed to mount under the face frame of Wall Cabinets.



Traditional Trim Moulding

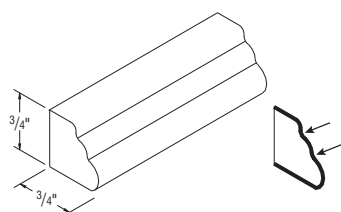

MTT8 (1 - 8' pc)



Finished edges indicated by bold lines on side view drawings.
 Glazed edges indicated by arrows on side view drawings.

DESIGN SOLUTIONS

▶ MTBAT8 can be used with Insert Crown Moulding.



Traditional Batten Moulding

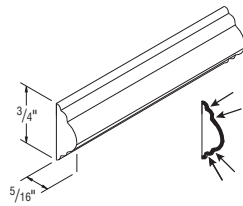

MTBAT8 (1 - 8' pc)

NOTES ✓

▶ MDENTIL8 can be used with Insert Crown Moulding.



Dentil Moulding

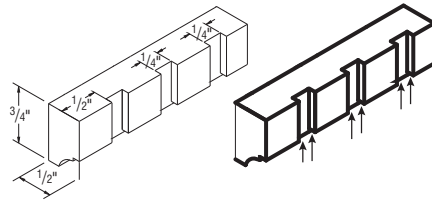

MDENTIL8 (1 - 8' pc)

DESIGN SOLUTIONS

▶ MROPE8 can be used with Insert Crown Moulding.



Rope Moulding

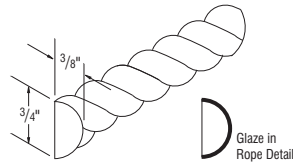

MROPE8 (1 - 8' pc)



Base Shoe Moulding

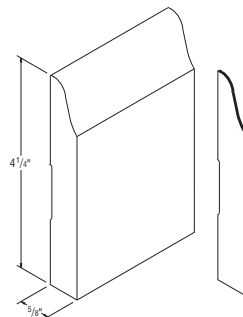

MBS8 (1 - 8' pc)

Finished edges indicated by bold lines on side view drawings.
Glazed edges indicated by arrows on side view drawings.

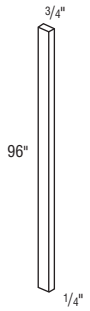

F14X96

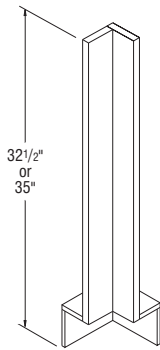

FBC3X332.5
FBC3X3

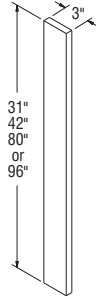

F331
F342
F380
F396

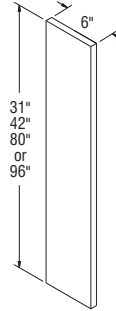

F631
F642
F680
F696

- ▶ FBC3X3 Overlays available for Briarcliff II, Durham, Eastland, Overton, and Wentworth. Must order separately under OL3X3 code.
- ▶ All Fillers finished on front and two long edges, except for F531A45 and BLVDFF331 which are finished on both sides and both long edges.
- ▶ All Fillers are 3/4" thick.
- ▶ BLVDFF331 - 45° reversible angled filler (fluted one side). Comes as a pair. Reversible, finished on back.
- ▶ F531A45 - 45° reversible decorative angled filler (fluted one side). Comes as a pair. Trimmable 2" top and bottom. Reversible, finished on back.
- ▶ TKF3 - Toekick Filler. Order under style #010.
- ▶ F14X96 is 1/4" thick. Designed to fill space between adjacent cabinets. When ordered with Rustic Birch door styles, will not feature Rustic characteristics. Finished 1/4" on front and 3/4" all edges (backs are not finished).

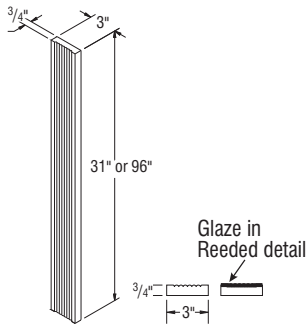

3" Reeded Fillers

FF331
FF396

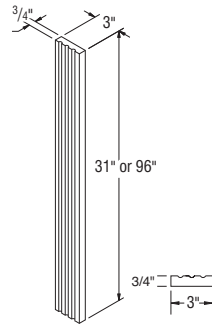

3" Fluted Fillers

FFL331
FFL396

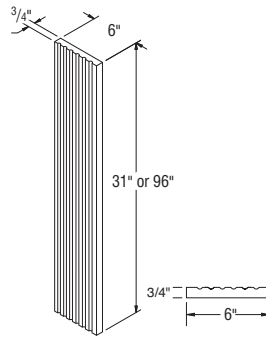

6" Fluted Fillers

FFL631
FFL696

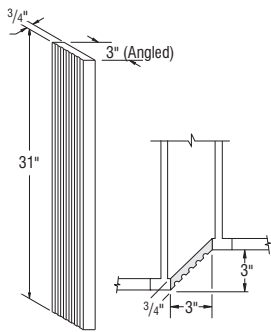

Angled Fluted/
Plain Filler

BLVDFF331

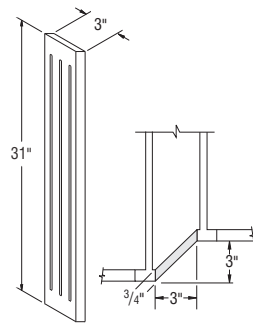

Decorative Angled Fluted/
Plain Filler

F531A45



TKF3*

*Order under style #010.



Overlays*

* Overlays are only available in Brellin, Briarcliff II, Durham, Eastland, Overton and Wentworth.

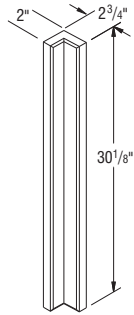

OL3X3

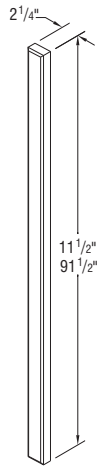

OL12

OL14

OL18

OL24

OL26

OL30

OL31

OL335

OL36

OL42

OL80

OL86

OL92

Model	Dimensions	Usage Details
OL3X3	2" x 30 ¹ / ₈ " & 2 ³ / ₄ " x 30 ¹ / ₈ "	FBC3X3 Base Corner Filler
OL12	2 ¹ / ₄ " x 11 ¹ / ₂ "	12" high Wall
OL14	2 ¹ / ₄ " x 13 ¹ / ₂ "	14" high Wall
OL18	2 ¹ / ₄ " x 17 ¹ / ₂ "	18" high Wall
OL24	2 ¹ / ₄ " x 23 ¹ / ₂ "	24" high Wall
OL26	2 ¹ / ₄ " x 25 ¹ / ₂ "	30" high Vanity
OL30	2 ¹ / ₄ " x 29 ¹ / ₂ "	30" high Wall
OL31	2 ¹ / ₄ " x 30 ¹ / ₈ "	35" high Base/Vanity
OL335	2 ¹ / ₄ " x 30 ¹ / ₈ "	PEPR335 Panels
OL36	2 ¹ / ₄ " x 35 ¹ / ₂ "	36" high Wall
OL42	2 ¹ / ₄ " x 41 ¹ / ₂ "	42" high Wall
OL80	2 ¹ / ₄ " x 79 ¹ / ₂ "	84" high Utility
OL86	2 ¹ / ₄ " x 85 ¹ / ₂ "	90" high Utility
OL92	2 ¹ / ₄ " x 91 ¹ / ₂ "	96" high Utility

Overlays*

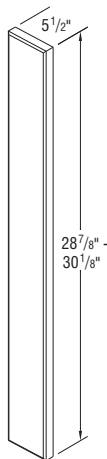

OL631

Model	Dimensions	Usage Details
OL631	Full Overlay Door Styles 5 ¹ / ₂ " x 30 ¹ / ₈ "	35" high Base/Vanity
	Partial Overlay Door Styles 5 ¹ / ₂ " x 28 ⁷ / ₈ "	35" high Base/Vanity

Split Turnings

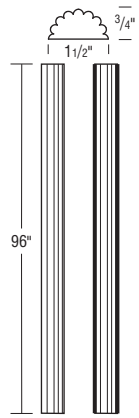

REED96
(each)

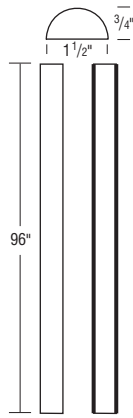

SPOOL96
(each)

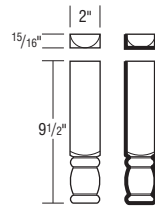

SPTRINGEND
(pair)

NOTES ✓

- ▶ SPTRINGEND is sold in pairs and are trimmable up to 5" each.



Rosette

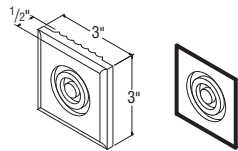

FFROS3X3

NOTES ✓

- ▶ Grooved to fit FFs.



Bar Bracket Corbel, 8" High *New*

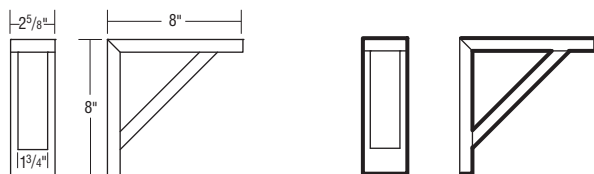

BARCORBEL8

NOTES ✓

- ▶ In order to support substantial weight, Corbels must be properly installed with the attachment screws driven into a stud wall.



Finished edges indicated by bold lines on side view drawings.

NOTES ✓

- ▶ In order to support substantial weight, Corbels must be properly installed with the attachment screws driven into a stud wall.



Cove Shaker Corbel, 12" High *New*

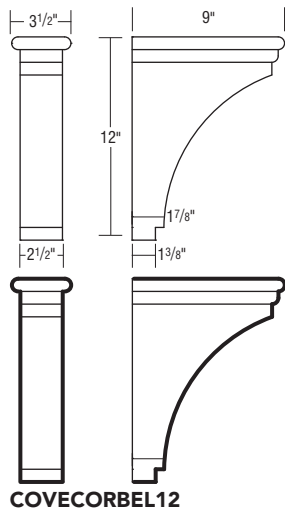

NOTES ✓

- ▶ In order to support substantial weight, Corbels must be properly installed with the attachment screws driven into a stud wall.



Shaker Corbel, 11" High *New*

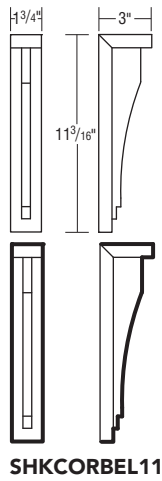

Finished edges indicated by bold lines on side view drawings.

Valance Corbels, 4" & 9 1/4" High

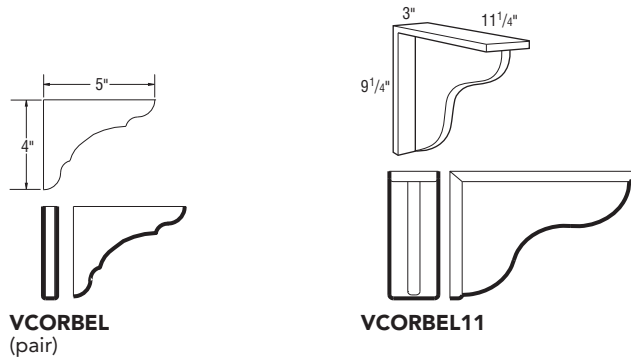

NOTES ✓

- ▶ Finished on all sides (reversible).
- ▶ Not intended to be used as a freestanding shelf support.
- ▶ VCORBEL sold in pairs.
- ▶ VCORBEL is 3/4" thick.
- ▶ VCORBEL11 has a 3" wide back plate.



Art Corbel, 9" High

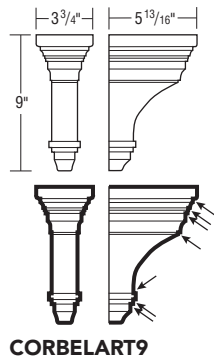

NOTES ✓

- ▶ In order to support substantial weight, Corbels must be properly installed with the attachment screws driven into a stud wall.



Mission Corbels, 6" & 9" High

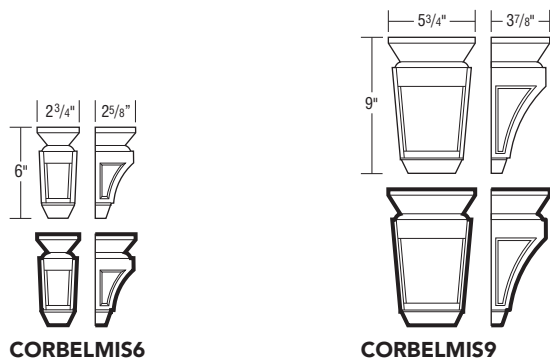

NOTES ✓

- ▶ In order to support substantial weight, Corbels must be properly installed with the attachment screws driven into a stud wall.



Finished edges indicated by bold lines on side view drawings.
Glazed edges indicated by arrows on side view drawings.

DESIGN SOLUTIONS

Corbels, 9" & 13" High

► In order to support substantial weight, Corbels must be properly installed with the attachment screws driven into a stud wall.

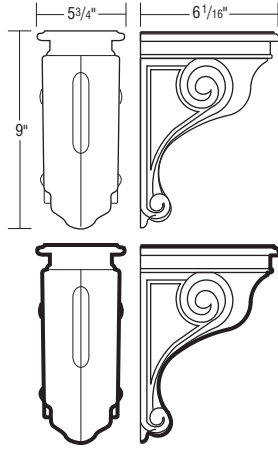

SMCORBEL

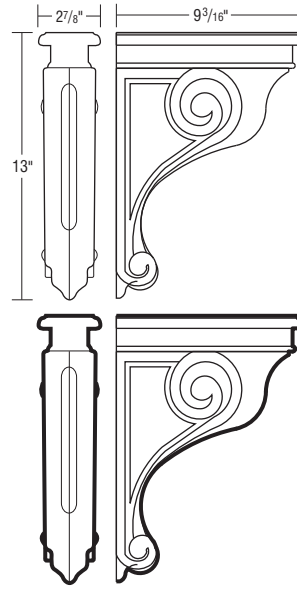

LGCORBEL

Finished edges indicated by bold lines on side view drawings.
 Glazed edges indicated by arrows on side view drawings.

Decorative Feet

NOTES ✓

► Trimmable.

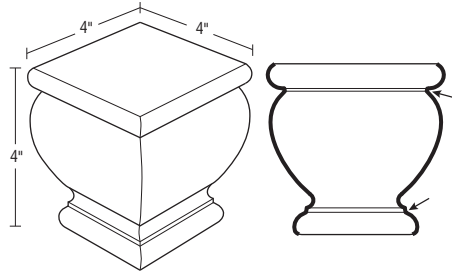

BUNLIFOOT *New*

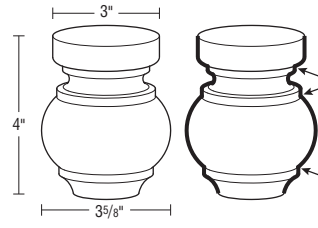

CRAFTFOOT *New*

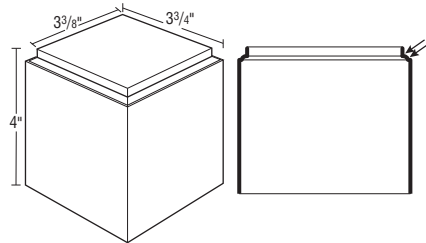

SQFOOT *New*

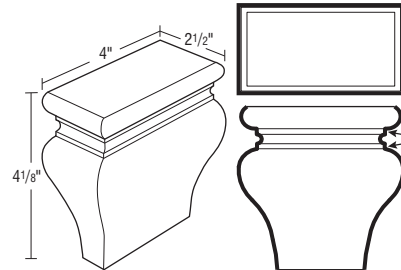

TKTLFOOT

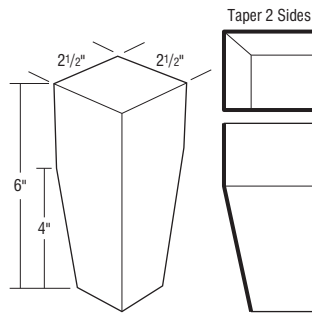

TAPLEG

Finished edges indicated by bold lines on side view drawings.
Glazed edges indicated by arrows on side view drawings.

► Trimmable.



Decorative Legs

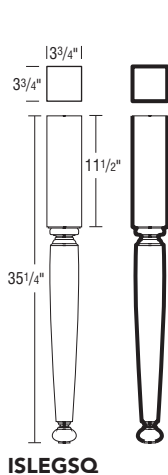

ISLEGSQ

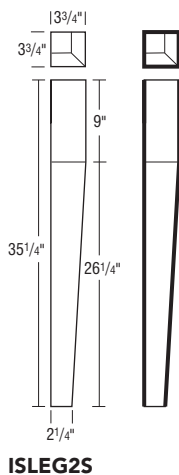

ISLEG2S

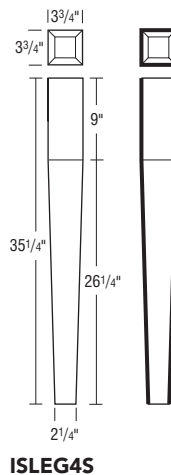

ISLEG4S

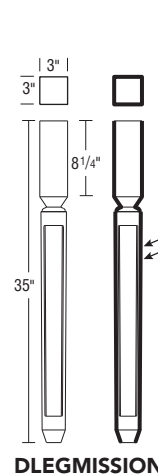

DLEMISSION

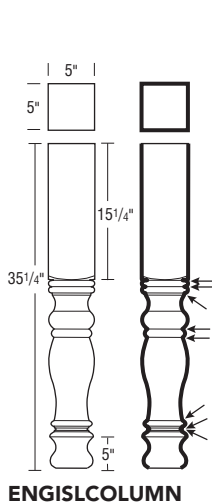

ENGISLCOLUMN

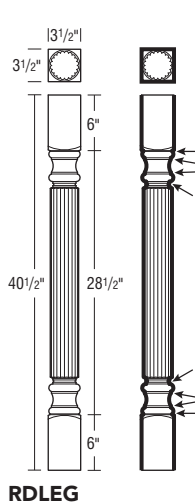

RDLEG

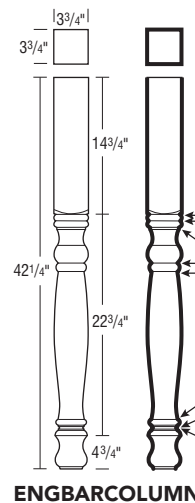

ENGBARCOLUMN

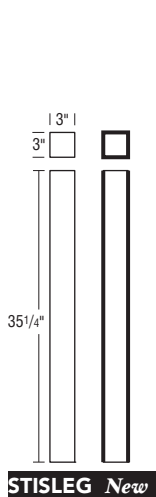

STISLEG *New*

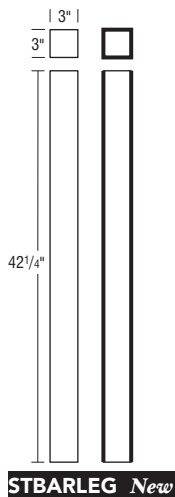

STBARLEG *New*

Finished edges indicated by bold lines on side view drawings.
Glazed edges indicated by arrows on side view drawings.

Valances Scalloped, 4 9/16" High

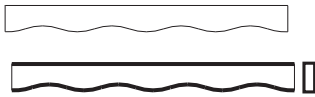

V549SC

Model	Length
V549SC	49"

DESIGN SOLUTIONS

- ▶ 3/4" thick.
- ▶ Trimmable up to 1/2" on each side: 1" overall.
- ▶ Valances not finished on back or ends.



Valances Arch, 5" High

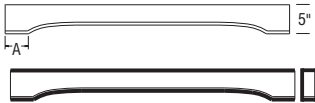

V525RA
V531RA
V537RA
V543RA
V549RA
V561RA
V573RA

Model	A =	Length
V525RA	4 1/4"	25"
V531RA	4 1/4"	31"
V537RA	4 1/4"	37"
V543RA	4 1/2"	43"
V549RA	4 1/2"	49"
V561RA	6"	61"
V573RA	6 3/4"	73"

NOTES ✓

- ▶ 3/4" thick.
- ▶ Valances not finished on back or ends.



Valances Straight, 5" High or 8 7/8" High

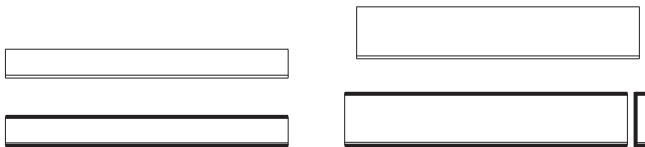

V531ST
V537ST
V540ST
V543ST
V546ST
V549ST
V561ST
V573ST

V937ST
V949ST
V961ST
V973ST

Model	Length
V531ST	31"
V537ST	37"
V540ST	40"
V543ST	43"
V546ST	46"
V549ST	49"
V561ST	61"
V573ST	73"
V937ST	37"
V949ST	49"
V961ST	61"
V973ST	73"

DESIGN SOLUTIONS

- ▶ 3/4" thick.
- ▶ Valances not finished on back or ends.



Finished edges indicated by bold lines on side view drawings.

- ▶ PEPR overlays available in Brellin, Briarcliff II, Durham, Eastland, and Wentworth. Must order separately under OL335 product code. (See page 152.)
- ▶ Plywood may contain MDF or particleboard in its core in accordance with ANSI/HPVA HP-1 standards.

Panels

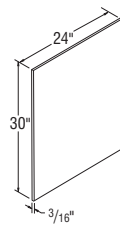

PDWP

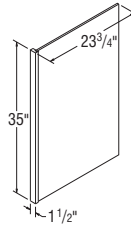

PEPR1.535
PEPR335 **

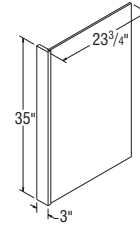

PEPRPLY1.535*
PEPRPLY335

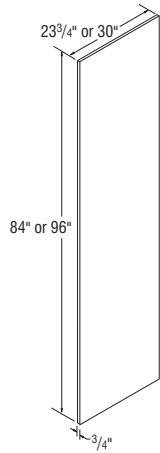

PREF2384
PREF2396
PREF3084 *New*
PREF3096 *New*

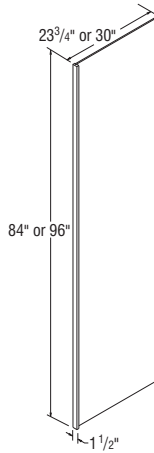

PREPRP1.584*
PREPRP1.596*
PREPR1.53084* *New*
PREPR1.53096* *New*

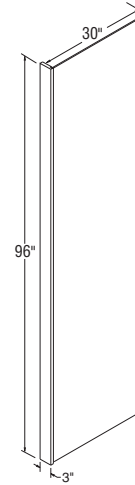

PREPR33096

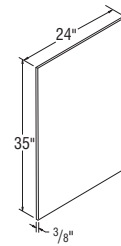

PSFEP

*When ordered in Rustic Finishes, rustic characteristics on Panel only.

**PEPR335 has rustic characteristics on Filler only.

Panel	Description	Size (T x W x H)	Edge Finish	Color Side 1	Color Side 2	Finish
PDWP	Dishwasher Front Panel	3/16" x 24" x 30"	None	Exterior	Raw	Veneer
PEPR1.535	Aristex™ 3/8" End Panel w/1 1/2" Stile	1 1/2" x 23 3/4" x 35"	Front Long	Exterior	Interior	Laminate
PEPR335 **	Aristex™ 3/8" End Panel w/3" Stile	3" x 23 3/4" x 35"	Front Long	Exterior	Interior	Laminate
PEPRPLY1.535 *	Plywood 3/8" End Panel w/1 1/2" Stile	1 1/2" x 23 3/4" x 35"	Front Long	Exterior	Interior	Laminate
PEPRPLY335	Plywood 3/8" End Panel/ Stile Complete	3" x 23 3/4" x 35"	Front Long	Exterior	Interior	Laminate
PREF2384	Particle Board Refrigerator End Panel	3/4" x 23 3/4" x 84"	1 Long	Exterior	Exterior	Veneer
PREF2396	Particle Board Refrigerator End Panel	3/4" x 23 3/4" x 96"	1 Long	Exterior	Exterior	Veneer
PREF3084	Particle Board Refrigerator End Panel	3/4" x 23 3/4" x 84"	1 Long	Exterior	Exterior	Veneer
PREF3096	Particle Board Refrigerator End Panel	3/4" x 23 3/4" x 96"	1 Long	Exterior	Exterior	Veneer
PREPRP1.584 *	Plywd. 3/8" Refrigerator End Panel w/1 1/2" Stile	1 1/2" x 23 3/4" x 84"	Front Long	Exterior	Exterior	Laminate
PREPRP1.596 *	Plywd. 3/8" Refrigerator End Panel w/1 1/2" Stile	1 1/2" x 23 3/4" x 96"	Front Long	Exterior	Exterior	Laminate
PREPR1.53084 *	Plywd. 3/8" Refrigerator End Panel w/1 1/2" Stile	1 1/2" x 23 3/4" x 84"	Front Long	Exterior	Exterior	Laminate
PREPR1.53096 *	Plywd. 3/8" Refrigerator End Panel w/1 1/2" Stile	1 1/2" x 23 3/4" x 96"	Front Long	Exterior	Exterior	Laminate
PREPR33096	Particle Board Refrigerator 3/4" End Panel w/3" Stile	3" x 30" x 96"	Front Long	Exterior	Exterior	Veneer
PSFEP	Aristex™ Sink End Panel	3/8" x 24" x 35"	None	Exterior	Interior	Laminate

NOTES ✓

► Plywood may contain MDF or particleboard in its core in accordance with ANSI/HPVA HP-1 standards.

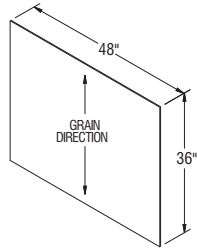

PA4836
P4836

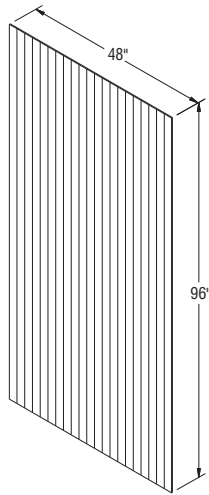

BP4896

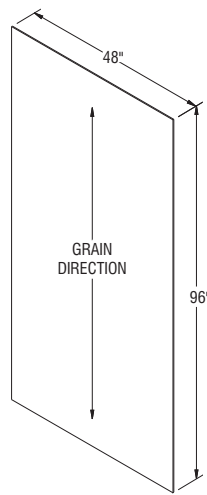

PA4896
P4896

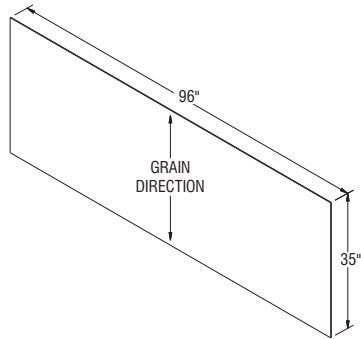

PP9635*

*PP9635 is not available in Antique, Glacier Gray, Stone Gray, and White.

Panel	Description	Size (T x W x H)	Edge Finish	Color Side 1	Color Side 2	Finish
BP4896	Beadboard Panel	3/16" x 48" x 96"	None	Exterior	Raw	Veneer
PA4836	Stock Panel - Aristex™ Laminate	1/4" x 48" x 36"	None	Exterior	Raw	Laminate
PA4896	Stock Panel - Aristex™ Laminate	1/4" x 48" x 96"	None	Exterior	Raw	Laminate
PP9635 *	Stock Panel - Veneer	3/16" x 96" x 35"	None	Exterior	Raw	Veneer
P4836	Stock Panel - Veneer	3/16" x 48" x 36"	None	Exterior	Raw	Veneer
P4896	Stock Panel - Veneer	3/16" x 48" x 96"	None	Exterior	Raw	Veneer

NOTES ✓

- ▶ End Panels are shipped one per carton. Not sold in pairs.
- ▶ EPV1430 and EPV1442 are sized for 15" deep cabinets.
- ▶ Plywood may contain MDF or particleboard in its core in accordance with ANSI/HPVA HP-1 standards.



Veneer End Panels

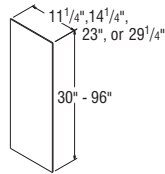

- EPV1130 EPV2335**
- EPV1142 EPV2384**
- EPV1430 EPV2396**
- EPV1442 EPV3096 *New***

Panel	Description	Size (T x W x H)	Edge Finish	Color Side 1	Color Side 2	Finish
EPV1130	Wall End Panel for 12" Depth	3/16" x 11 1/4" x 30"	None	Exterior	Raw	Veneer
EPV1142	Wall End Panel for 12" Depth	3/16" x 11 1/4" x 42"	None	Exterior	Raw	Veneer
EPV1430	Wall End Panel for 15" Depth	3/16" x 14 1/4" x 30"	None	Exterior	Raw	Veneer
EPV1442	Wall End Panel for 15" Depth	3/16" x 14 1/4" x 42"	None	Exterior	Raw	Veneer
EPV2335	Base End Panel	3/16" x 23" x 35"	None	Exterior	Raw	Veneer
EPV2384	Utility End Panel	3/16" x 23" x 84"	None	Exterior	Raw	Veneer
EPV2396	Utility End Panel	3/16" x 23" x 96"	None	Exterior	Raw	Veneer
EPV3096	Utility End Panel	3/16" x 29 1/4" x 96"	None	Exterior	Raw	Veneer

DESIGN SOLUTIONS

- ▶ 1/4" thick panels with one-sided Aristex™ laminate on exterior (no edge finish).
- ▶ End Panels are shipped one per carton. Not sold in pairs.
- ▶ EPA1430 and EPA1442 are sized for 15" deep cabinets.



Laminate End Panels

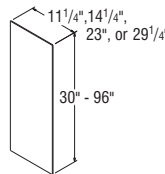

- EPA1130 EPA2335**
- EPA1142 EPA2384**
- EPA1430 EPA2396**
- EPA1442 EPA3096 *New***

Panel	Description	Size (T x W x H)	Edge Finish	Color Side 1	Color Side 2	Finish
EPA1130	Wall End Panel for 12" Depth	1/4" x 11 1/4" x 30"	None	Exterior	Raw	Laminate
EPA1142	Wall End Panel for 12" Depth	1/4" x 11 1/4" x 42"	None	Exterior	Raw	Laminate
EPA1430	Wall End Panel for 15" Depth	1/4" x 14 1/4" x 30"	None	Exterior	Raw	Laminate
EPA1442	Wall End Panel for 15" Depth	1/4" x 14 1/4" x 42"	None	Exterior	Raw	Laminate
EPA2335	Base End Panel	1/4" x 23" x 35"	None	Exterior	Raw	Laminate
EPA2384	Utility End Panel	1/4" x 23" x 84"	None	Exterior	Raw	Laminate
EPA2396	Utility End Panel	1/4" x 23" x 96"	None	Exterior	Raw	Laminate
EPA3096	Utility End Panel	1/4" x 29 1/4" x 96"	None	Exterior	Raw	Laminate

Decorative End Panels

NOTES

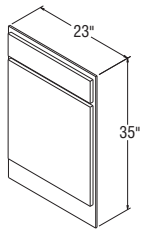

DBEP*

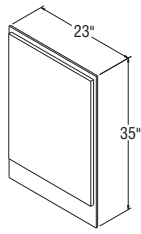

DBEPFH*

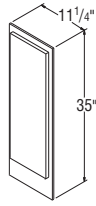

DBEPFH-12*

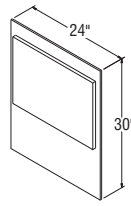

DDWP

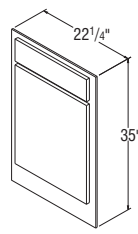

DPBEP*

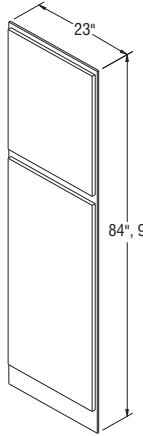

DUEP84*
DUEP90*
DUEP96*

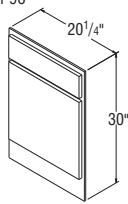

DVEP*

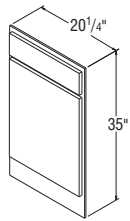

DVEP35*

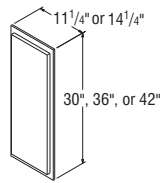

DWEP30*
DWEP36*
DWEP42*
DWEP1530*
DWEP1536*
DWEP1542*

- ▶ DBEP and DPBEP include one door and one drawer front on an EP2335 Veneer End Panel and five screws for mounting.
- ▶ DBEPFH includes one door on an EP2335 Veneer End Panel and five screws for mounting.
- ▶ DBEPFH-12 includes one door on a Veneer Panel and five screws for mounting.
- ▶ DDWP includes one door, one Panel 24" x 30", and screws for installation. Shipped unassembled.
- ▶ DUEP includes two doors and one EP__ Veneer End Panel, and screws for assembly. Shipped assembled.
- ▶ DUEP includes three doors on miter styles.
- ▶ DVEP includes one door, one drawer front, and one Panel 20 1/4" x 30", and screws for assembly. Shipped assembled.
- ▶ DWEP parts include one door and an EP__ Veneer End Panel and four screws for mounting. Shipped assembled.
- ▶ Actual sizes of doors and drawer fronts used will vary slightly by style. For exact dimensions, refer to parts dimension guide.
- ▶ Panel construction is the same for Standard, Select, and APC.
- ▶ Plywood may contain MDF or particleboard in its core in accordance with ANSI/HPVA HP-1 standards.

*Specify L or R on full overlay styles for all Decorative Panels except DDWP.

Panel	Description	Size (T x W x H)	Edge Finish	Color Side 1	Color Side 2	Finish
DBEP & DBEPFH *	Decorative Base End	3/16" x 23" x 35"	None	Exterior	Raw	Veneer
DBEPFH-12 *	Decorative Base End for 12" Depth	3/16" x 11 1/4" x 35"	None	Exterior	Raw	Veneer
DDWP	Decorative Dishwasher Front	3/16" x 24" x 30"	None	Exterior	Raw	Veneer
DPBEP *	Decorative Peninsula Base End	3/16" x 22 1/4" x 35"	None	Exterior	Raw	Veneer
DUEP84 *	Decorative Utility End	3/16" x 23" x 84"	None	Exterior	Raw	Veneer
DUEP90 *	Decorative Utility End	3/16" x 23" x 90"	None	Exterior	Raw	Veneer
DUEP96 *	Decorative Utility End	3/16" x 23" x 96"	None	Exterior	Raw	Veneer
DVEP *	Decorative Vanity End	3/16" x 20 1/4" x 30"	None	Exterior	Raw	Veneer
DVEP35 *	Decorative Vanity End	3/16" x 20 1/4" x 35"	None	Exterior	Raw	Veneer
DWEP30 *	Decorative Wall End	3/16" x 11 1/4" x 30"	None	Exterior	Raw	Veneer
DWEP36 *	Decorative Wall End	3/16" x 11 1/4" x 36"	None	Exterior	Raw	Veneer
DWEP42 *	Decorative Wall End	3/16" x 11 1/4" x 42"	None	Exterior	Raw	Veneer
DWEP1530 *	Decorative Wall End for 15" Depth	3/16" x 14 1/4" x 30"	None	Exterior	Raw	Veneer
DWEP1536 *	Decorative Wall End for 15" Depth	3/16" x 14 1/4" x 36"	None	Exterior	Raw	Veneer
DWEP1542 *	Decorative Wall End	3/16" x 14 1/4" x 42"	None	Exterior	Raw	Veneer

NOTES ✓

- ▶ 3/4" thick.
- ▶ Veneer panel with front edge banded and both sides finished.



Vanity Tapered End Panel, 30" High, 21" Deep

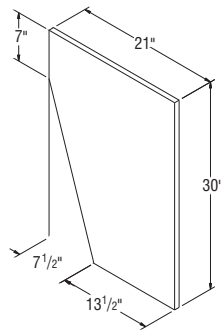

VTEP

NOTES ✓

- ▶ Rail, Panel, and Toekick.
- ▶ 27" opening.

DESIGN SOLUTIONS

- ▶ Use drawer front to cover bottom portion of panel.



Range Panel, 35" High

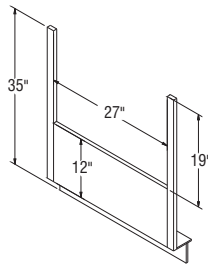

RP30

NOTES ✓

- ▶ Plywood may contain MDF or particleboard in its core in accordance with ANSI/HPVA HP-1 standards.



Toekick

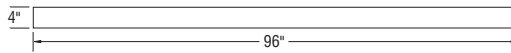

- TOEKICK8 (1 - 8' pc)**
- TOEKICK (4 - 8' pc)**
- TOEKICKPLY8 (1 - 8' pc)**

Panel	Description	Size (T x W x H)	Edge Finish	Color Side 1	Color Side 2	Finish
TOEKICK8	Aristex™ Toekick	1/4" x 4" x 96"	None	Exterior	Raw	Laminate
TOEKICK	Aristex™ Toekick	1/4" x 4" x 96"	None	Exterior	Raw	Laminate
TOEKICKPLY8	Plywood Toekick	1/4" x 4" x 96"	None	Exterior	Raw	Veneer