







# ZP2 Series Installation Manual

<b>Copyright</b>	© 2013 UTC Fire & Security. All rights reserved.
<b>Trademarks and patents</b>	ZP2 Series is a trademark of UTC Fire & Security. Other trade names used in this document may be trademarks or registered trademarks of the manufacturers or vendors of the respective products.
<b>Manufacturer</b>	UTC CCS Manufacturing Polska Sp. Z o.o. Ul. Kolejowa 24. 39-100 Ropczyce, Poland  Authorized EU manufacturing representative: UTC Fire & Security B.V. Kelvinstraat 7, 6003 DH Weert, Netherlands
<b>Version</b>	This document covers control panels with firmware version 3.0 or later.
<b>Certification</b>	
<b>European Union directives</b>	1999/5/EC (R&TTE directive): Hereby, UTC Fire & Security declares that this device is in compliance with the essential requirements and other relevant provisions of Directive 1999/5/EC. 2004/108/EC (EMC directive). 2002/96/EC (WEEE directive):  Products marked with this symbol cannot be disposed of as unsorted municipal waste in the European Union. For proper recycling, return this product to your local supplier upon the purchase of equivalent new equipment, or dispose of it at designated collection points. For more information see: <a href="http://www.recyclethis.info">www.recyclethis.info</a> .   2006/66/EC (battery directive): This product contains a battery that cannot be disposed of as unsorted municipal waste in the European Union. See the product documentation for specific battery information. The battery is marked with this symbol, which may include lettering to indicate cadmium (Cd), lead (Pb), or mercury (Hg). For proper recycling, return the battery to your supplier or to a designated collection point. For more information see: <a href="http://www.recyclethis.info">www.recyclethis.info</a> .
<b>Contact information</b>	For contact information, see <a href="http://www.utcssecurityproducts.eu">www.utcssecurityproducts.eu</a> .

# Content

	Important information	ii
<b>Chapter 1</b>	<b>Introduction</b>	<b>1</b>
	Product range	2
	Product compatibility	3
	Product overview	4
<b>Chapter 2</b>	<b>Installation</b>	<b>15</b>
	Electrical safety	16
	Cabinet and PCB layout	17
	Cabinet installation	19
	Connections	24
<b>Chapter 3</b>	<b>Configuration and commissioning</b>	<b>35</b>
	Introduction	36
	Maintenance level operation and configuration	40
	Installer level operation and configuration	53
	Commissioning	102
<b>Chapter 4</b>	<b>Maintenance</b>	<b>105</b>
	Fire alarm system maintenance	106
	Battery maintenance	107
<b>Chapter 5</b>	<b>Technical specifications</b>	<b>109</b>
<b>Appendix A</b>	<b>Default configurations</b>	<b>117</b>
<b>Appendix B</b>	<b>PSTN country codes</b>	<b>119</b>
<b>Appendix C</b>	<b>Menu maps</b>	<b>121</b>
<b>Appendix D</b>	<b>Regulatory information</b>	<b>129</b>
	<b>Index</b>	<b>133</b>

# Important information

## Introduction

This is the installation manual for the ZP2 Series fire alarm, repeater, and evacuation control panels. Read these instructions and all related documentation entirely before installing or operating this product.

## Firmware compatibility

Information in this document covers control panels with firmware version 3.0 or later. This document must not be used as a guide to installation, configuration, or operation of control panels with an earlier firmware version.

To check the firmware version of your control panel, see the Revision report in the Reports menu.

## Limitation of liability

To the maximum extent permitted by applicable law, in no event will UTCFS be liable for any lost profits or business opportunities, loss of use, business interruption, loss of data, or any other indirect, special, incidental, or consequential damages under any theory of liability, whether based in contract, tort, negligence, product liability, or otherwise. Because some jurisdictions do not allow the exclusion or limitation of liability for consequential or incidental damages the preceding limitation may not apply to you. In any event the total liability of UTCFS shall not exceed the purchase price of the product. The foregoing limitation will apply to the maximum extent permitted by applicable law, regardless of whether UTCFS has been advised of the possibility of such damages and regardless of whether any remedy fails of its essential purpose.

Installation in accordance with this manual, applicable codes, and the instructions of the authority having jurisdiction is mandatory.

While every precaution has been taken during the preparation of this manual to ensure the accuracy of its contents, UTCFS assumes no responsibility for errors or omissions.

## Advisory messages

Advisory messages alert you to conditions or practices that can cause unwanted results. The advisory messages used in this document are shown and described below.

---

**WARNING:** Warning messages advise you of hazards that could result in injury or loss of life. They tell you which actions to take or to avoid in order to prevent the injury or loss of life.

---

---

**Caution:** Caution messages advise you of possible equipment damage. They tell you which actions to take or to avoid in order to prevent the damage.

---

**Note:** Note messages advise you of the possible loss of time or effort. They describe how to avoid the loss. Notes are also used to point out important information that you should read.



# Chapter 1

# Introduction

## Summary

This chapter provides an introduction to your control panel, the main controls, and the indicators.

## Content

Product range	2
Product compatibility	3
Product overview	4
The user interface	4
Front panel controls and indicators	6
LCD controls and indicators	10
Acoustic indicators	12
Conditions	12

## Product range

The series includes the fire alarm, repeater, and evacuation panels shown below.

**Table 1: Fire alarm, repeater, and evacuation panels**

Model	Description
ZP2-E1(-S) [1]	One-loop addressable fire and evacuation alarm control panel
ZP2-E2(-S)	Two-loop addressable fire and evacuation alarm control panel
ZP2-ER(-S)	Addressable fire and evacuation alarm repeater panel
ZP2-F1(-S)	One-loop addressable fire alarm control panel
ZP2-F1-FB2(-S)	One-loop addressable fire alarm control panel with fire routing and fire protection controls
ZP2-F1-SC(-S)	One-loop addressable fire alarm control panel with fire routing and fire protection controls [2]
ZP2-F1-SCFB(-S)	One-loop addressable SS 3654 fire alarm control panel with fire routing and fire protection controls [2]
ZP2-F2(-S)	Two-loop addressable fire alarm control panel
ZP2-F2-PRT	Two-loop addressable fire alarm control panel with internal printer
ZP2-F2-FB2(-S)	Two-loop addressable fire alarm control panel with fire routing and fire protection controls
ZP2-F2-FB2-PRT	Two-loop addressable fire alarm control panel with fire routing and fire protection controls and internal printer
ZP2-F2-SC(-S)	Two-loop addressable fire alarm control panel with fire routing and fire protection controls [2]
ZP2-F2-SCFB(-S)	Two-loop addressable SS 3654 fire alarm control panel with fire routing and fire protection controls [2]
ZP2-F2-SCFB-PRT	Two-loop addressable SS 3654 fire alarm control panel with fire routing and fire protection controls and internal printer [2]
ZP2-FR(-S)	Addressable fire alarm repeater panel
ZP2-FR-FB2(-S)	Addressable fire alarm repeater panel with fire routing and fire protection controls
ZP2-FR-SC(-S)	Addressable fire alarm repeater panel with fire routing and fire protection controls [2]
ZP2-FR-SCFB(-S)	Addressable SS 3654 fire alarm repeater panel with fire routing and fire protection controls [2]

[1] (-S) indicates that large and small cabinet models are available. See Chapter 5 “Technical specifications” on page 109 for cabinet dimensions.

[2] Includes a fireman's key.

### Repeater functionality

All control panels in a fire network can be configured for repeater functionality, provided that they have a network board installed. For more information, see “Firenet configuration” on page 55.



## **Fire routing and fire protection control and indication**

In this document, information on control and indication for fire routing and fire protection applies only to control panels that include those features.

## **Product compatibility**

Products compatible with these control panels are listed in the supplied compatibility list. Only those products specified in the compatibility list are guaranteed to be compatible with these control panels. For further details contact your local supplier.

# Product overview

This topic provides an introduction to the control panel user interface, LCD, operator controls, and indicators.

For a detailed overview of front panel controls and indicators, see “Front panel controls and indicators” on page 6.

## The user interface

Figure 1: Fire panel user interface (with fire routing and fire protection controls)

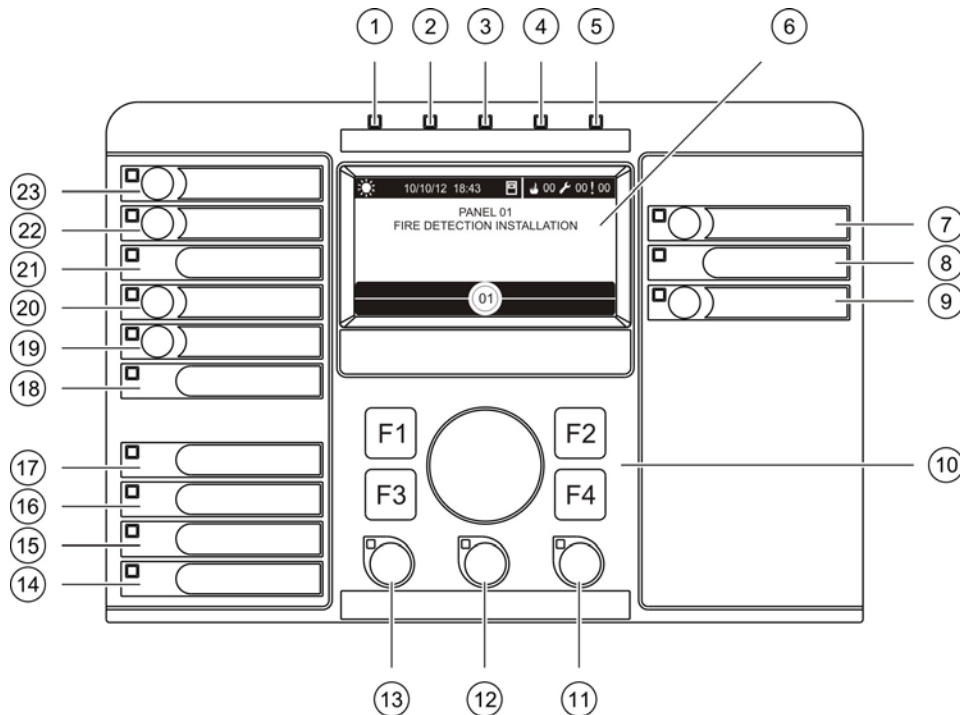

- |                                    |  |
|------------------------------------|--|
| 1. Supply LED                      | 13. Sounder Start/Stop Button and LED              |
| 2. General Test LED                | 14. System Fault LED                               |
| 3. General Disable LED             | 15. Low Battery LED                                |
| 4. General Fault LED               | 16. Earth Fault LED                                |
| 5. Alarm LED                       | 17. Supply Fault LED                               |
| 6. LCD                             | 18. Fire Protection Fault/Disabled/Test LED        |
| 7. Sounder Delay button and LED    | 19. Fire Protection Delay button and LED           |
| 8. Sounder Fault/Disabled/Test LED | 20. Fire Protection On/Acknowledged button and LED |
| 9. Reserved for future use         | 21. Fire Routing Fault/Disabled/Test LED           |
| 10. Jog dial and function buttons  | 22. Fire Routing Delay button and LED              |
| 11. Reset button and LED           | 23. Fire Routing On/Acknowledged button and LED    |
| 12. Panel Silence button and LED   |  |

Figure 2: Evacuation panel user interface

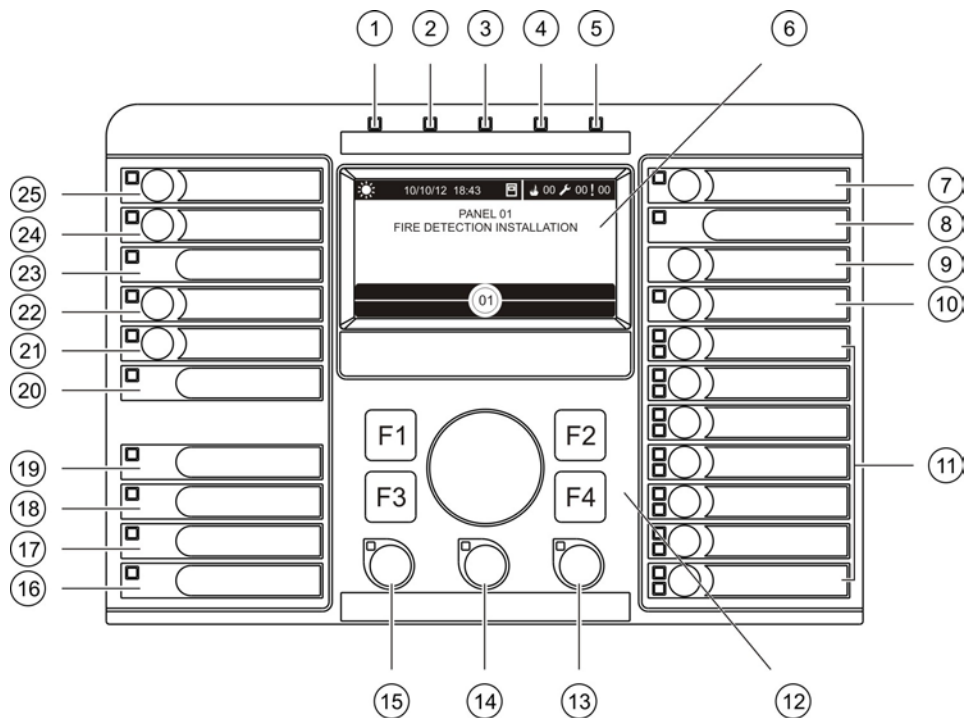

- |   |  |
|---|--|
| 1. Supply LED   | 14. Panel Silence button and LED                   |
| 2. General Test LED                                       | 15. Sounder Start/Stop Button and LED              |
| 3. General Disable LED                                    | 16. System Fault LED                               |
| 4. General Fault LED                                      | 17. Low Battery LED                                |
| 5. Alarm LED  | 18. Earth Fault LED                                |
| 6. LCD  | 19. Supply Fault LED                               |
| 7. Sounder Delay button and LED                           | 20. Fire Protection Fault/Disabled/Test LED        |
| 8. Sounder Fault/Disabled/Test LED                        | 21. Fire Protection Delay button and LED           |
| 9. Confirm button   | 22. Fire Protection On/Acknowledged button and LED |
| 10. All Output Groups Start/Stop Button and LED           | 23. Fire Routing Fault/Disabled/Test LED           |
| 11. Programmable output group start/stop buttons and LEDs | 24. Fire Routing Delay button and LED              |
| 12. Jog dial and function buttons                         | 25. Fire Routing On/Acknowledged button and LED    |
| 13. Reset button and LED                                  |  |

See “Assigning an output group to a programmable button” on page 90 for more information on configuring programmable buttons.

## Configuration options

Depending on your configuration, the labels for some interface buttons may change. See Table 2 below.

**Table 2: Configured changes to interface buttons and LEDs**

Item	EN 54	NEN 2575
10	All Output Groups Start/Stop	All Evacuation Start/Stop
11	Programmable output group start/stop	Evacuation area sounders start/stop [1]
15	Sounder Start/Stop	Fire Sounder Start/Stop

[1] If the evacuation panel is operating in NEN 2575 mode, only sounder output groups can be associated with the programmable start/stop buttons.

## Front panel controls and indicators

Operational features described in this section are not available to all users. More information on control panel operation and access restrictions can be found in the topic “User levels” on page 36.

### Common controls and indicators

The table below includes information for the common controls and indicators available for fire, repeater, and evacuation panels.

**Table 3: Common controls and indicators**

Control/LED	LED colour	Description
Supply LED	Green	Indicates that the system is powered up.
General Test LED	Yellow	Indicates that one or more features or devices are being tested.
General Disable LED	Yellow	Indicates that one or more features or devices are disabled.
General Fault LED	Yellow	Indicates a general fault. The fault LED for the corresponding device or feature also flashes.
Alarm LED	Red	Indicates a fire alarm.  A flashing LED indicates that the alarm was activated by a detector. A steady LED indicates that the alarm was activated by a manual call point.
Fire Routing On/Acknowledged button and LED	Red	Cancels a previously configured delay as it counts down and activates fire routing.  A flashing LED indicates that fire routing has been activated. A steady LED indicates that the fire routing signal has been acknowledged by the remote monitoring equipment.

<b>Control/LED</b>	<b>LED colour</b>	<b>Description</b>
Fire Routing Delay button and LED	Yellow	Enables or disables a previously configured fire routing delay. Cancels a delay as it counts down and activates fire routing.  A steady LED indicates that a delay is configured and enabled. A flashing LED indicates that a delay is counting (fire routing is activated when the configured delay elapses or when the delay is cancelled).
Fire Routing Fault/Disabled/Test LED	Yellow	Indicates a fire routing fault, disablement, or test.  A flashing LED indicates a fault. A steady LED indicates a disablement or a test.
Fire Protection On/Acknowledged button and LED	Red	Cancels a previously configured delay as it counts down and activates fire protection.  A flashing LED indicates that fire protection has been activated. A steady LED indicates that the fire protection signal has been acknowledged by the remote monitoring equipment.
Fire Protection Delay button and LED	Yellow	Enables or disables a previously configured fire protection delay. Cancels a delay as it counts down and activates fire protection.  A steady LED indicates that a delay is configured and enabled. A flashing LED indicates that a delay is counting (fire protection is activated when the configured delay elapses or when the delay is cancelled).
Fire Protection Fault/Disabled/Test LED	Yellow	Indicates a fire protection fault, disablement, or test.  A flashing LED indicates a fault. A steady LED indicates a disablement or a test.
Sounder Delay button and LED	Yellow	Enables or disables a previously configured sounder delay. Cancels a delay as it counts down and activates sounders.  A steady LED indicates that a sounder delay is configured and enabled. A flashing LED indicates a delay is counting (sounders are activated when the configured delay elapses or when the delay is cancelled).
Sounder Fault/Disabled/Test LED	Yellow	Indicates a sounder fault, disablement, or test.  A flashing LED indicates a fault. A steady LED indicates a disablement or a test.
Supply Fault LED	Yellow	Indicates a power supply fault.  A flashing LED indicates a battery fault. A steady LED indicates a mains or mains fuse fault.
Earth Fault LED	Yellow	Indicates an earth isolation fault.
Low Battery LED	Yellow	Indicates that the control panel is running on battery power and that the remaining charge may be insufficient to guarantee continued operation.
System Fault LED	Yellow	Indicates a control panel system failure.

Control/LED	LED colour	Description
Sounder Start/Stop button and LED	Red	<p>The LED indicates what happens when the button is pressed.</p> <p>If the LED is on (flashing or steady), pressing the button silences the sounders.</p> <p>If the LED is off, pressing the button activates the sounders (if the control panel status and operating mode allow manual activation of sounders).</p> <p>The LED also indicates the status of the sounders:</p> <ul style="list-style-type: none"> <li>• Steady indicates that sounders are active (or will be activated shortly)</li> <li>• Flashing indicates that a delay is counting (sounders are activated when the configured delay elapses or when the delay is cancelled)</li> <li>• Off indicates that the sounders are off (or will be deactivated shortly)</li> </ul> <p>To prevent the immediate silencing of sounders when an alarm is first reported, the Sounder Start/Stop button may be temporarily blocked when a configured sounder delay is counting down. For more information, see “Sounders silence disable time” on page 98.</p> <p>Depending on the size of the installation, processing commands to start or stop sounders may take a few seconds to travel through the system. This is why, for example, the LED may be steady but sounders may not initially be audible.</p>
Panel Silence button and LED	Yellow	<p>Silences the control panel buzzer.</p> <p>A steady LED indicates that the buzzer has been silenced.</p>
Reset button and LED	Yellow	<p>Resets the control panel and clears all current system events.</p> <p>A steady LED indicates that the control panel can be reset in the current user level.</p>

## Evacuation panel controls and indicators

The table below includes information for the additional controls and indicators for evacuation panels.

**Note:** If the evacuation panel is operating in NEN 2575 mode, only sounder output groups can be associated with the programmable start/stop buttons.

**Table 4: Evacuation panel controls and indicators**

Control/LED	LED colour	Description
Confirm button		<p>Confirms the starting or stopping of the output group associated with a programmable button (when pressed with the corresponding programmable button).</p> <p>Confirms the starting or stopping of all output groups associated with all programmable buttons (when pressed with the All Output Groups Start/Stop button).</p>
All Output Groups Start/Stop button and LED	Red	<p>Starts or stops all output groups associated with the programmable buttons (when pressed with the Confirm button).</p> <p>A steady red LED indicates that all output groups associated with the buttons are active. A flashing red LED indicates that a delay is counting (the output groups are activated when the configured delay elapses or when the delay is cancelled).</p>
Programmable start/stop buttons and LEDs	Red/Yellow	<p>Starts or stops the the output group associated with the programmable button (when pressed with the Confirm button).</p> <p>A steady red LED indicates that the output group associated with the button is active. A flashing red LED indicates that a delay is counting (the output group is activated when the configured delay elapses or when the delay is cancelled).</p> <p>A flashing yellow LED indicates a fault. A steady yellow LED indicates a disablement or a test.</p>

## Output group LED indications

The control panel can be configured to have several sounder, fire routing, or fire protection output groups. Some groups may use the same indicators. When such groups have the same status, that status is indicated. In the case of conflicting status, the highest priority status is displayed.

**Note:** For evacuation panels, indications for output groups associated with the programmable buttons use the corresponding programmable button LEDs.

The following examples illustrate this operation.

There are three sounder output groups, the first in fault status, the second in delayed status, and the third in activated status. The sounder indications display the fault status of the first group, the delay status of the second group, and the activated status of the third group.

There are two fire routing output groups, the first is in activated status and the second is in acknowledged status. The fire routing indication displays the acknowledged status but not the activation status (the acknowledgement status takes priority).

For more information on output groups, see “Output groups” on page 86.

## LCD controls and indicators

Figure 3: LCD controls and indicators

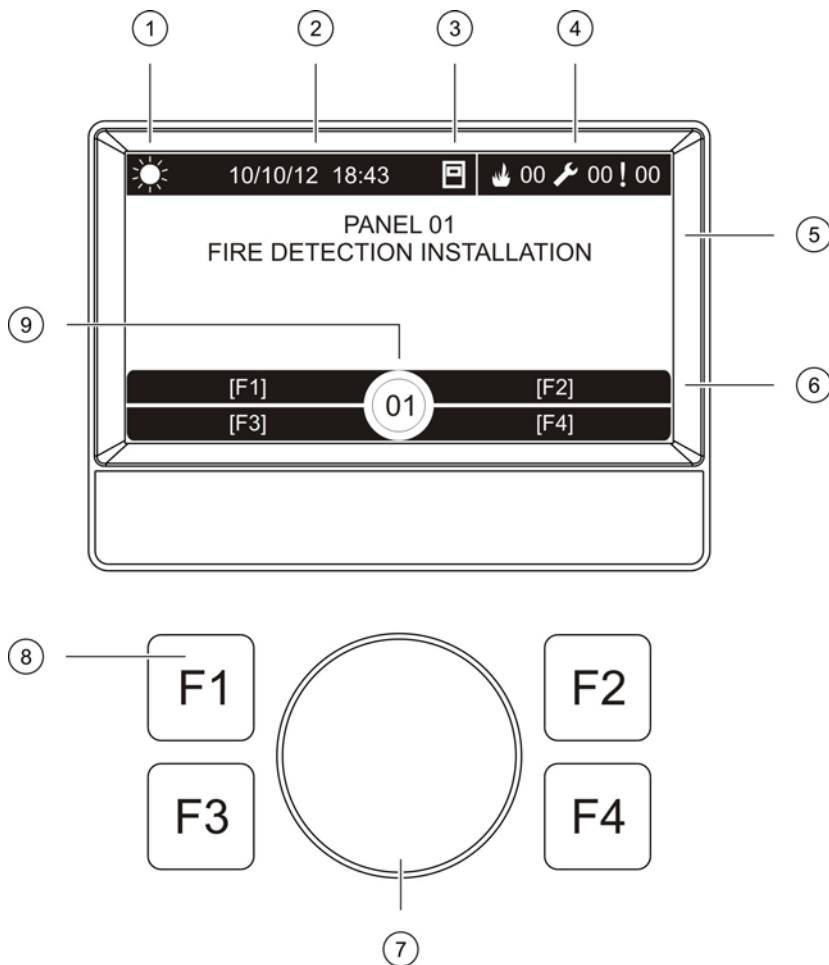















1. Day/night mode indicator
2. System date and time
3. Control panel network status (stand-alone, networked, repeater)
4. Current alarm, fault, and condition events counter
5. Message display area
6. Soft keys (menu options linked to function buttons F1, F2, F3, and F4)
7. Jog dial
8. Function buttons F1, F2, F3, and F4
9. Local control panel ID (in a fire network)



## Icons displayed on the LCD

Icons displayed on the LCD are shown below.

**Table 5: LCD icons and descriptions**

Icon	Description
 Day mode (network)	This icon indicates that the primary sensitivity mode setting for control panels in the fire network is day mode.
 Day mode (control panel)	This icon indicates that the sensitivity mode for the local control panel is day mode. Other control panels in the fire network may have a different sensitivity mode setting.
 Night mode (network)	This icon indicates that the primary sensitivity mode setting for control panels in the fire network is night mode.
 Night mode (control panel)	This icon indicates that the sensitivity mode for the local control panel is night mode. Other control panels in the fire network may have a different sensitivity mode setting.
 Fire alarms	The number beside this icon indicates the number of zones with an active fire alarm. Alarm information for the first and last zones to report an alarm is displayed in the LCD message area.
 Faults	The number beside this icon indicates the number of active faults. Additional information is available by pressing F1 (Show Events).
 Conditions	The number beside this icon indicates the number of active system conditions. Additional information is available by pressing F1 (Show Events).
 Stand-alone	This icon indicates that the control panel is not connected to the fire network.
 Networked	This icon indicates that the control panel is connected to the fire network.
 Repeater	This icon indicates that the control panel is configured to operate as a repeater and is connected to the fire network.
 Detector alarm [1]	This icon indicates a detector alarm.
 Manual call point alarm [1]	This icon indicates a manual call point alarm.
 Manual call point alarm (sprinkler) [1]	This icon indicates a manual call point alarm (sprinkler).
 Manual call point alarm (“hausalarm”) [1]	This icon indicates a manual call point alarm (“hausalarm”). This is a local alarm with no fire routing activation.

[1] These icons appear in the message display area with the notification details.

## Indication of remote and local events on the LCD

The local control panel ID is always displayed on the LCD (see Figure 3 on page 10).

If your control panel forms part of a fire network, the event notification includes the panel ID reporting the event as follows:

- If the panel ID matches the local ID, then the event relates to the local control panel
- If the panel ID does not match the local ID, then the event is reported by the remote control panel with the panel ID indicated

Repeater panels are installed only in fire networks and by default have a network board installed. Fire alarm control panels must have a network board installed to connect to a fire network.

## Acoustic indicators

The control panel buzzer acts as an acoustic indicator to highlight system events.

**Table 6: Control panel acoustic indicators**

Indication	Description
The buzzer sounds continuously	Indicates a fire alarm or a system fault
The buzzer sounds intermittently (long tone) [1]	Indicates all other faults
The buzzer sounds intermittently (short tone) [1]	Indicates a condition

[1] A long tone is 50% ON and 50% OFF. A short tone is 25% ON and 75% OFF.

## Conditions

A summary of system events logged as conditions is shown below.

**Table 7: System events logged as conditions**

Condition type	Description
Alert	A device is in alarm but the system is waiting for an additional alarm event to confirm the zone alarm
Configuration device connected	A control panel configuration session is initiated via an external device (PC, laptop, etc.)
Date and time not set	The system started but the date and time are not set
Disablements	A control panel feature or device is disabled
Event log full	The control panel event log is full
Extinguishing status [1]	Extinguishing is blocked, disabled, or has a fault
Extinguishing I/O device [1]	An extinguishing I/O device is active, being tested, is disabled, or has a fault
Input activation	An input is activated (subject to configuration)

Condition type	Description
Loop device not configured	A loop device is detected that is not configured
Maximum conventional zones exceeded in a network	The number of conventional zones in a fire network exceeds the maximum allowed (64)
Maximum loops exceeded in a network	The number of loops in a fire network exceeds the maximum allowed (32)
New node in the fire network	A control panel has been added to the fire network
Output group activation	An output group is activated
Prealarm	A device (and corresponding zone) is in prealarm
Sounder, fire routing, and fire protection delays	A sounder, fire routing, or fire protection delay is enabled or disabled
Tests	A control panel feature or device is being tested

[1] These condition types only apply if an extinguishing panel is included in the fire network.

In addition to the above, the following system status events are also added to the event log (but are not included in the control panel current events report).

**Table 8: Other system status events added to the event log**

Event	Description
Actions	An output group is activated or deactivated or a programmable system command is executed (via the Configuration Utility)
Conditions deactivation	A system condition is deactivated
General system events	The control panel is reset, the panel is silenced, a new date and time is set, the system is initiated, etc.
Power supply faults eliminated	A previously logged power supply fault is resolved
Rules activation	A rule is activated [1]
User sessions	The date and time information for activation and termination of user sessions

[1] A rule consists of one or more states (combined by Boolean operators) that are configured to trigger specific system actions after a specific confirmation time. Rules are created using the Configuration Utility.



# Chapter 2

## Installation

### Summary

This chapter provides detailed installation and connection information for your control panel.

---

**Caution:** This product must be installed and maintained by qualified personnel adhering to the CEN/TS 54-14 standard (or the corresponding national standard) and any other applicable regulations.

---

### Content

Electrical safety	16
Cabinet and PCB layout	17
Cabinet installation	19
Where to install the control panel	19
Fixing the cabinet to the wall	19
Adding the menu inserts	20
Connecting the user interface cable	21
Connecting the internal printer and loading paper	22
Connections	24
Recommended cables	24
Overview of fire system connections	25
Connecting loops	26
Connecting loop devices	28
Connecting inputs	28
Connecting outputs	28
Connecting the mains power supply	30
Connecting the batteries	32
Connecting expansion boards	32
Connecting a fire network	32
Connecting an external printer or ASCII terminal	34

## Electrical safety

---

**WARNING:** Electrocution hazard. To avoid personal injury or death from electrocution, remove all sources of power and allow stored energy to discharge before installing or removing equipment.

---

**Caution:** Equipment damage hazard. This product is sensitive to electrostatic discharge (ESD). To avoid damage, follow accepted ESD handling procedures.

---

# Cabinet and PCB layout

Figure 4: Large cabinet and PCB layout (two-loop control panel)

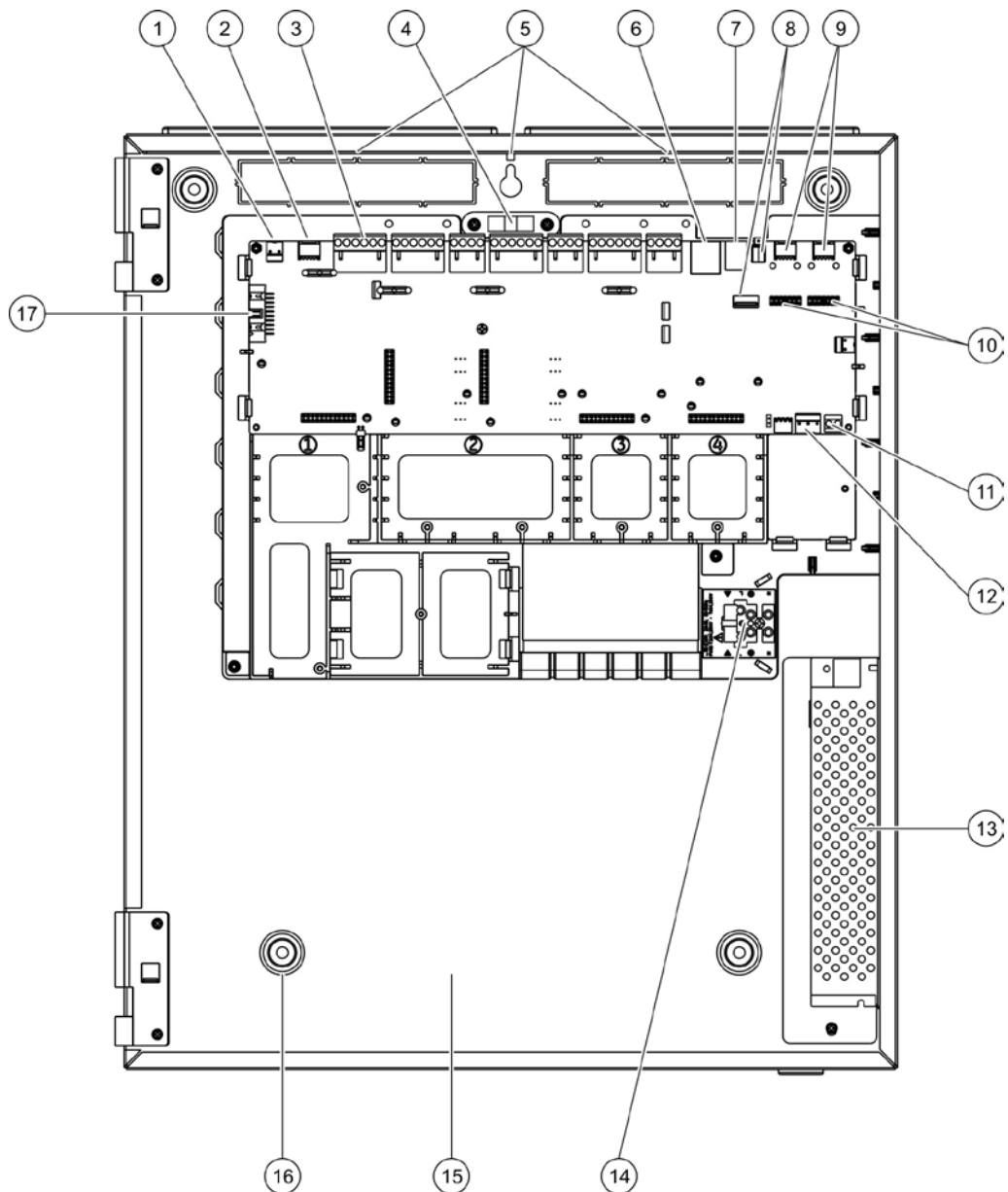

- |                                    |  |
|------------------------------------|--|
| 1. 24V connector                   | 9. COM0 and COM1 serial ports          |
| 2. COM2 serial port                | 10. COM0 and COM1 interface connectors |
| 3. Loop and fire system connectors | 11. Battery connector                  |
| 4. Spirit level                    | 12. Power supply connector             |
| 5. Earth studs                     | 13. Power supply                       |
| 6. Ethernet connector              | 14. Mains terminal block and fuse      |
| 7. USB type B connector            | 15. Battery area                       |
| 8. USB type A connectors           | 16. Mounting holes                     |
|                                    | 17. User interface connector           |

**Figure 5: Small cabinet and PCB layout (two-loop control panel)**

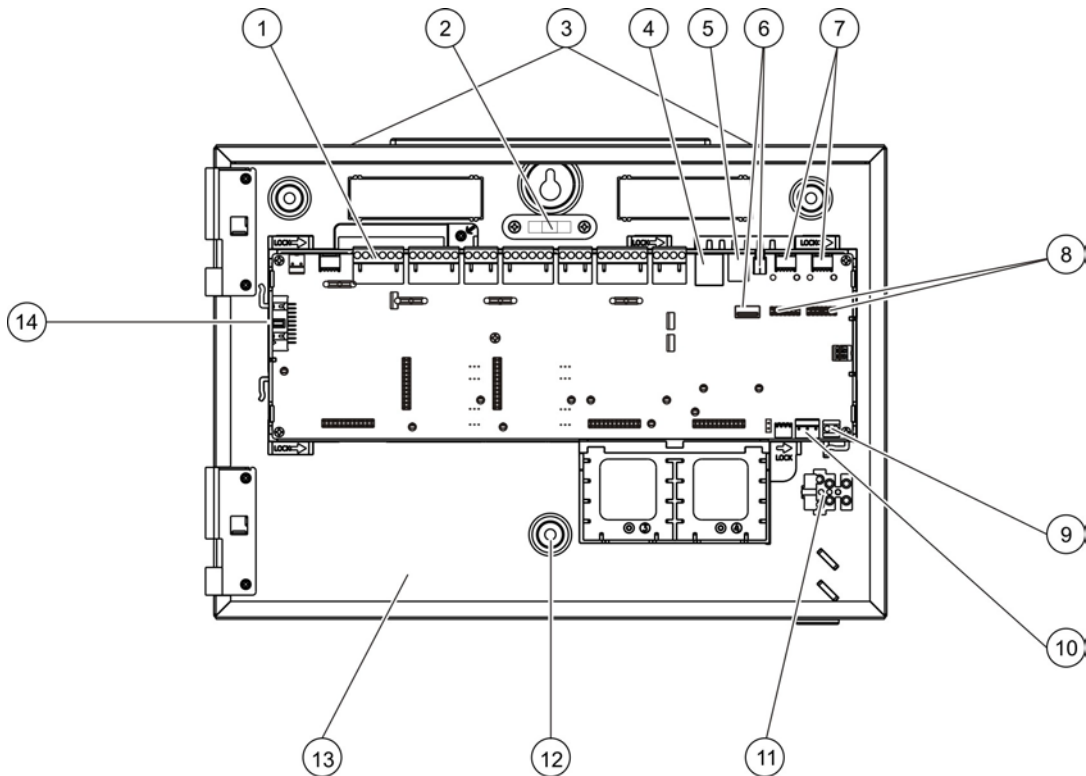

- |                                    |                                       |
|------------------------------------|---------------------------------------|
| 1. Loop and fire system connectors | 8. COM0 and COM1 interface connectors |
| 2. Spirit level                    | 9. Battery connector                  |
| 3. Earth studs                     | 10. Power supply connector            |
| 4. Ethernet connector              | 11. Mains terminal block and fuse     |
| 5. USB type B connector            | 12. Mounting holes                    |
| 6. USB type A connectors           | 13. Battery area                      |
| 7. COM0 and COM1 serial ports      | 14. User interface connector          |

**Figure 6: Small cabinet with main PCB and chassis removed to show power supply**

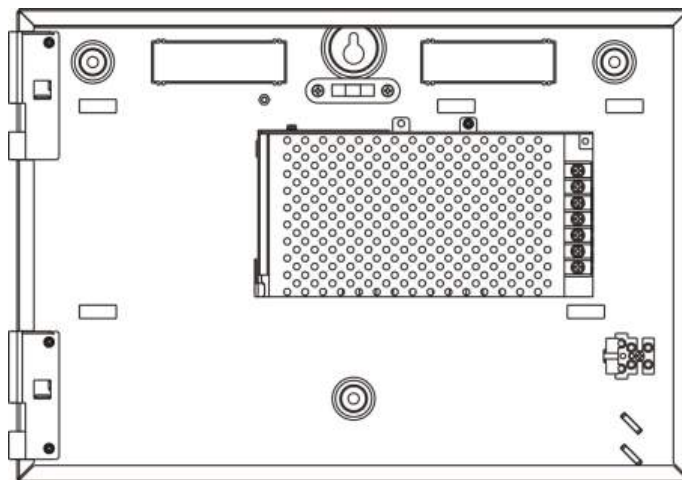



# Cabinet installation

## Where to install the control panel

Install the control panel in a location that is free from construction dust and debris, and immune to extreme temperature ranges and humidity. See Chapter 5 “Technical specifications” on page 109 for more information on the operating temperature and relative humidity specifications.

Provide enough floor and wall space to allow the control panel to be installed and serviced without any obstructions.

The cabinet should be mounted so that the user interface is at eye level.

**Note:** This product has been certified to EN 54-2 using the standard wall mounting installation method described below. If other mounting options are used, take care to install the panel in an area that is not subject to excessive vibration or shock.

## Fixing the cabinet to the wall

Fix the cabinet to the wall using five M4 × 30 screws and five Ø 6 mm wall plugs, as shown in Figure 7 below.

Figure 7: Mounting hole locations

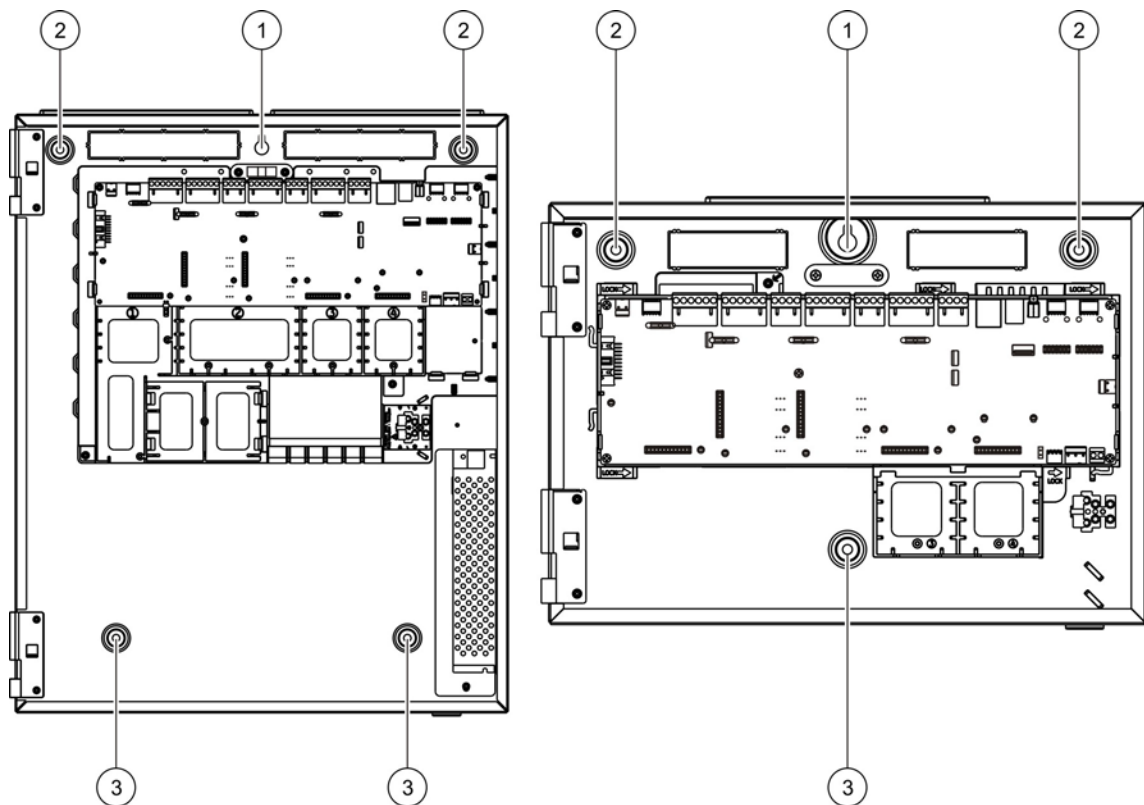

**To fix the cabinet to the wall:**

1. Hold the cabinet to the wall at the required installation height.
2. Ensure that the cabinet is level using the built-in spirit level and mark drill points on the wall.
3. Drill all required holes and insert a 6 mm wall plug into each.
4. Insert a screw in position (1) and hang the cabinet onto this screw.
5. Insert screws in positions (2) and tighten.
6. Insert screws in position (3) and tighten.
7. Tighten screw in position (1).

**Adding the menu inserts**

Add the control panel interface menus as shown below.

**Figure 8: Adding the menu inserts**

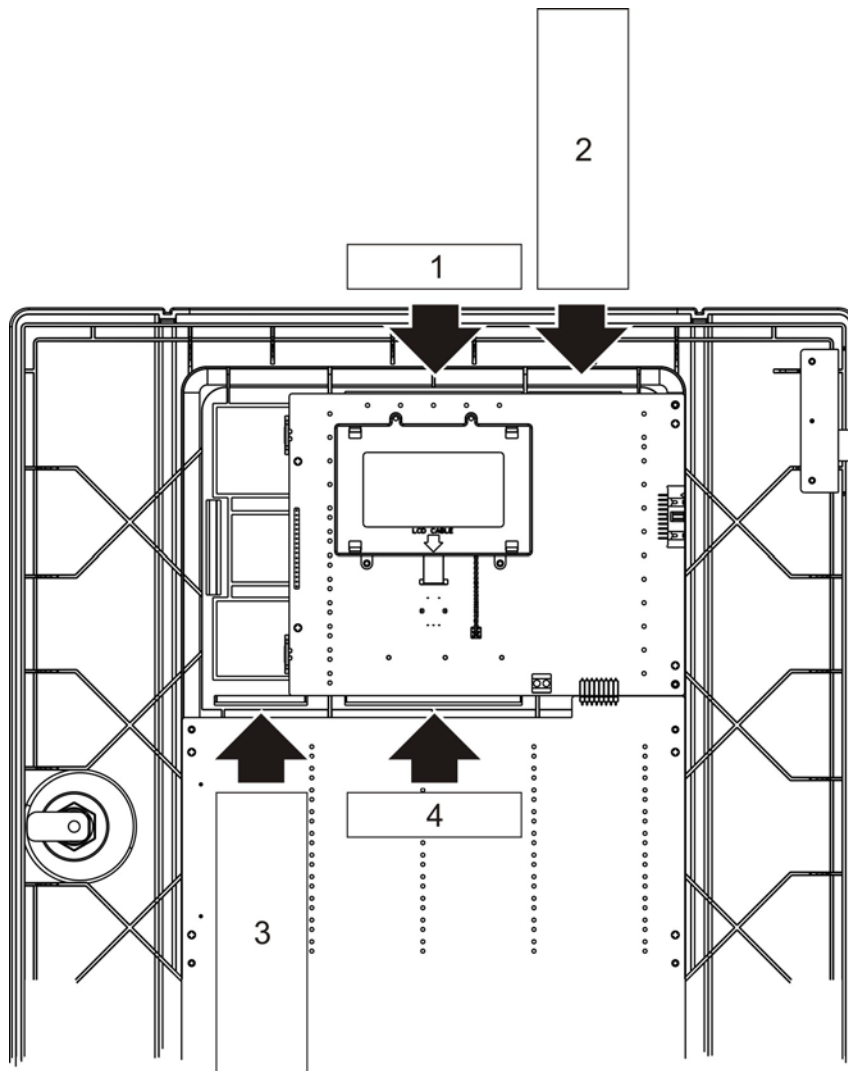

The inserts are numbered 1, 2, 3, and 4, and are inserted at the location indicated (with the printed area facing the front of the control panel).

For evacuation panels, remember to add descriptions for any output groups assigned to the programmable buttons to insert 3.

**Note:** Different versions of insert 3 are provided for fire panels and for evacuation panels, and each is marked with the corresponding control panel product code. Be sure to use the correct version of the insert for your product.

## Connecting the user interface cable

Connect the user interface cable as shown below.

Figure 9: Connecting the user interface cable

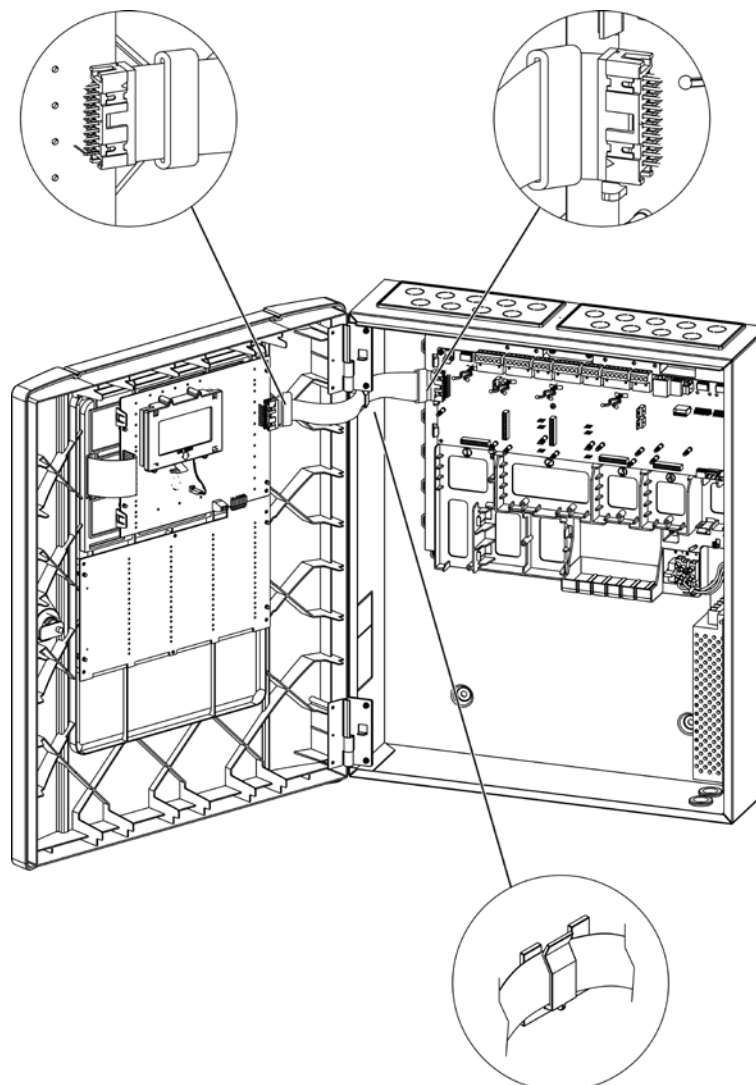

## Connecting the internal printer and loading paper

This topic shows you how to connect the internal printer and load the printer with paper. See “Printer configuration” on page 69 for printer configuration options.

The internal printer is only available on selected models.

### Connecting the internal printer

Connect the internal printer as shown below.

Figure 10: Connecting the internal printer

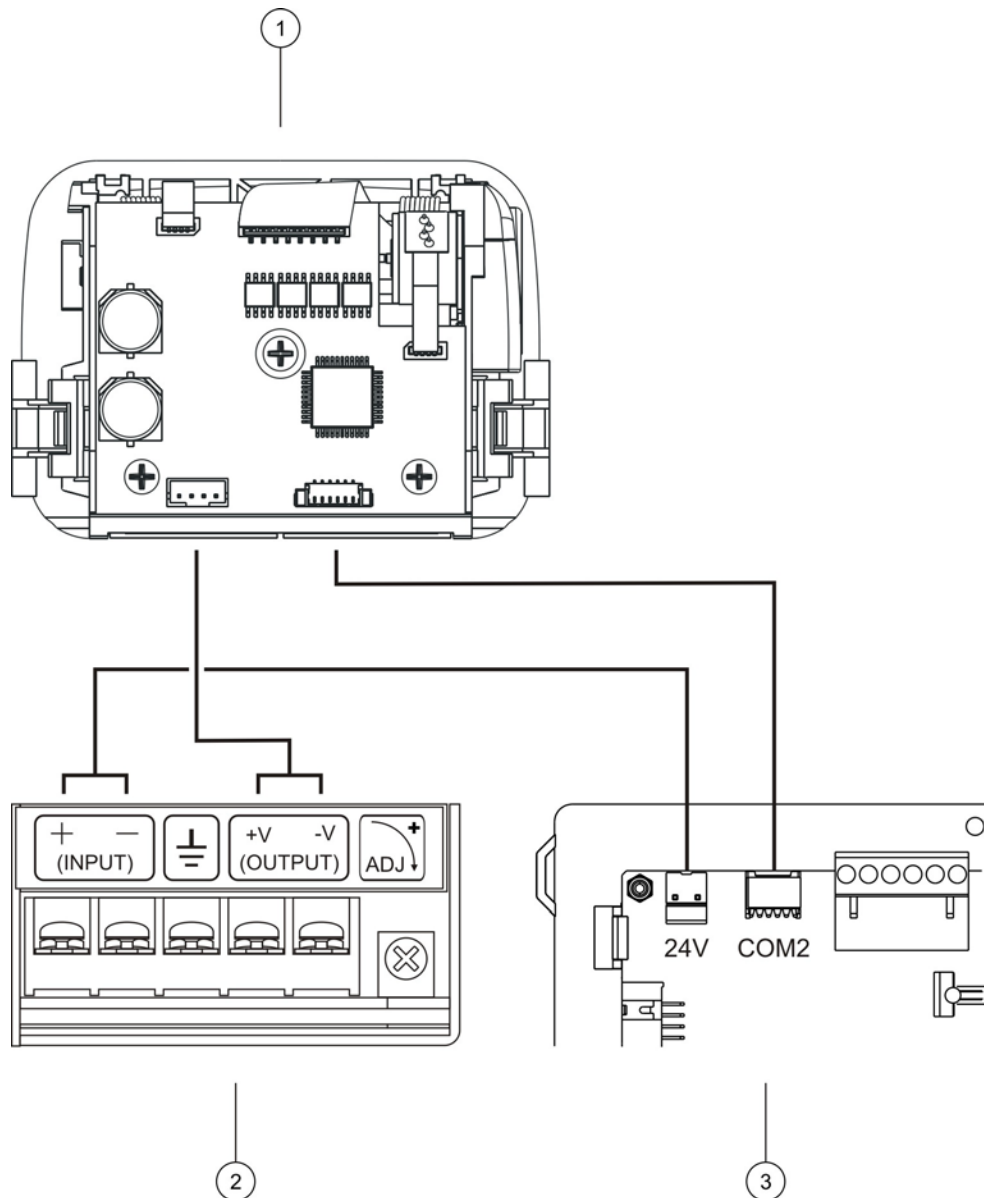

1. Internal printer
2. Internal printer PSU
3. Control panel PCB

## Loading paper

Load the paper for the internal printer as shown below.

Figure 11: Loading the paper for the internal printer

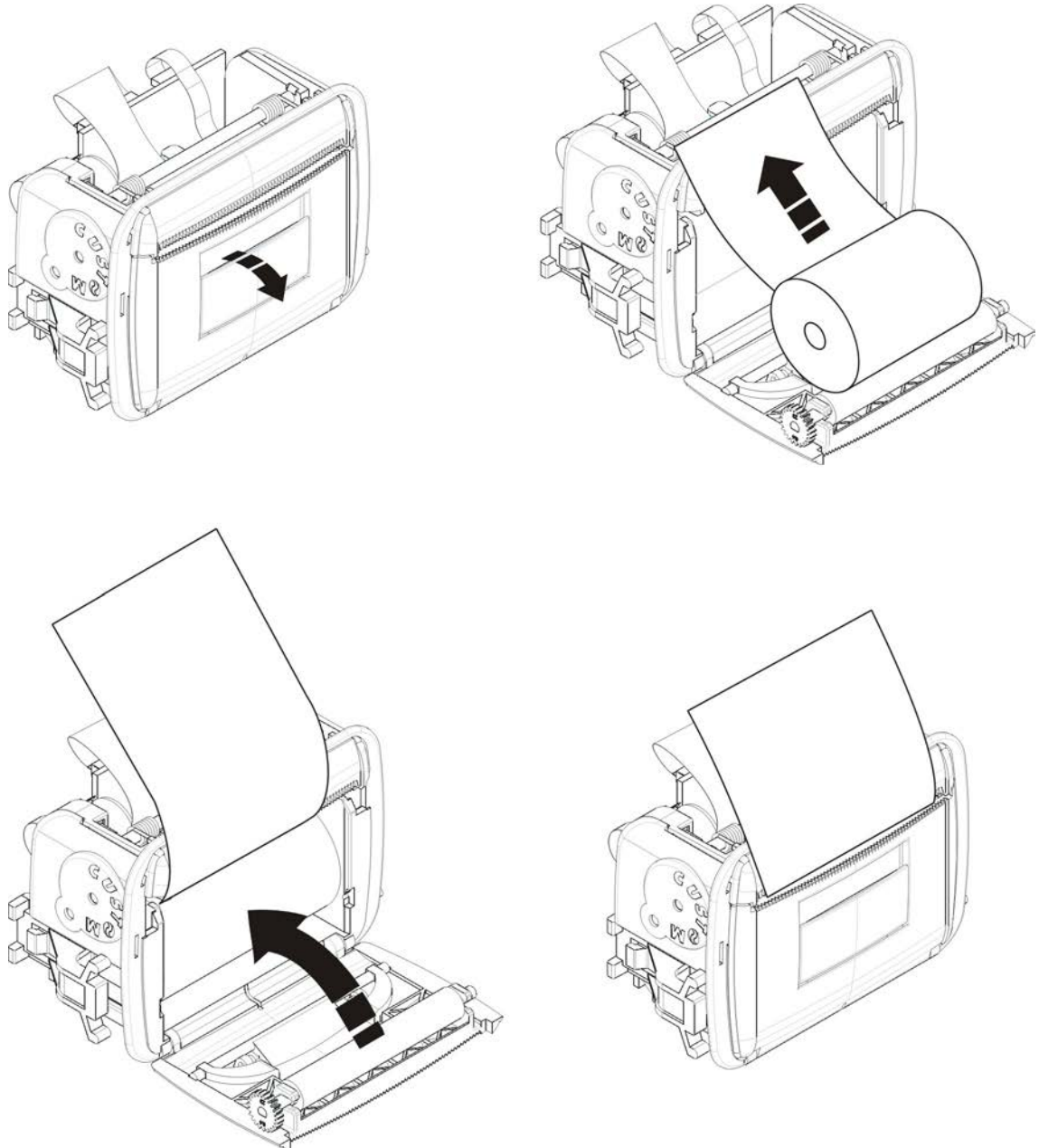

# Connections

## Recommended cables

Recommended cables for optimal system performance are shown in the table below.

**Table 9: Recommended cables**

Cable	Cable requirements	Maximum cable length
Mains cable	3 × 1.5 mm <sup>2</sup>	N/A
Loop cable	Twisted-pair (75 Ω and 700 nF max.) 12 to 26 AWG (0.13 to 3.31 mm <sup>2</sup> )	3.5 km [1][2]
Fire network cable	Twisted-pair, CAT5 12 to 26 AWG (0.13 to 3.31 mm <sup>2</sup> )	1.2 km
Ethernet cable	Unshielded CAT5	30 m [3]
USB cable	Standard USB cable with A-B connectors	10 m
External printer cable	Accessory cable 2010-2-232-KIT [4]	3 m

[1] Based on 3.5 km max. cable length with 2 mm<sup>2</sup> diameter for up to 127 devices.

[2] Maximum cable length depends on the type of cable used and the loop load.

[3] Connect the control panel to an Ethernet hub installed within 30 m if greater distances are required.

[4] This kit contains a 3 m cable and the 2010-2-232-IB isolation board required for external RS-232 device connections.

Other types of cable may be used subject to site-specific electromagnetic interference (EMI) conditions and installation testing.

### Using shielded loop cable

In most installations shielded loop cable is not required and the system has been validated to operate in standard conditions with unshielded twisted-pair cable.

However, shielded cable provides more flexibility in solving site-specific EMI problems and may be used, subject to following these guidelines:

- Use a multimeter to check that the shield is fully isolated from earth, the loop positive, and the loop negative lines before connecting the shield to a single point in the installation. The same isolation must be provided for any other site wiring and loop cabling should avoid any known sources of EMI at the site.
- Use the earth studs in the control panel cabinet (if you need to reduce interference. See Figure 4 on page 17 or Figure 5 on page 18 for the location of the earth studs.

The PCB terminal earthing connections only improve noise immunity in very specific environmental conditions. In some cases, leaving the earth fully isolated provides the best protection against EMI.

To determine noise immunity, check the communications error rate and the stability of analogue values for installed devices.

### Securing cables

Use 20 mm cable glands to ensure clean and secure connections. All cables should be fed through the cable guides in the cabinet housing to eliminate movement.

## Overview of fire system connections

Figure 12: Overview of typical fire system connections with a single Class A loop

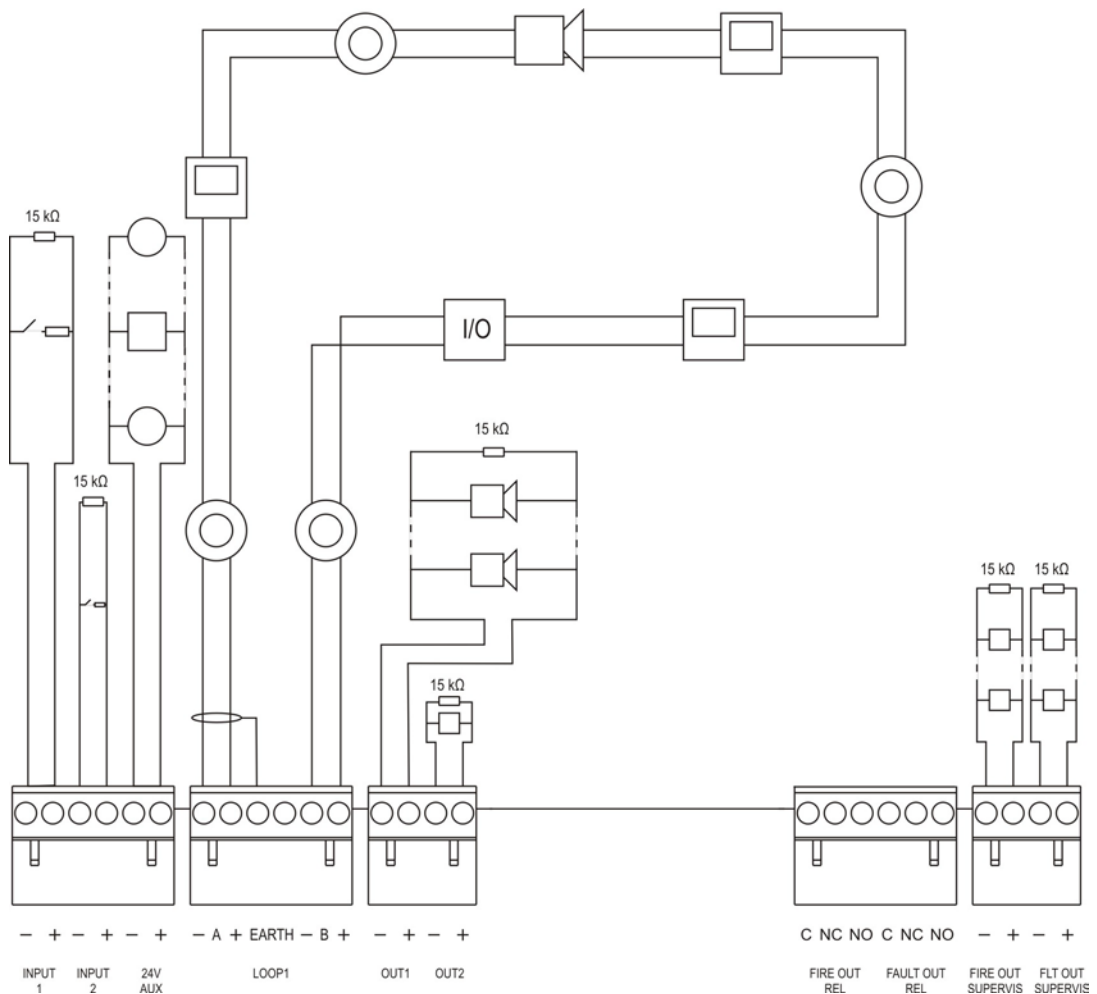

For input activation characteristics, see “Connecting inputs” on page 28.

**Figure 13: Overview of EN 54-13 fire system connections with a single Class A loop**

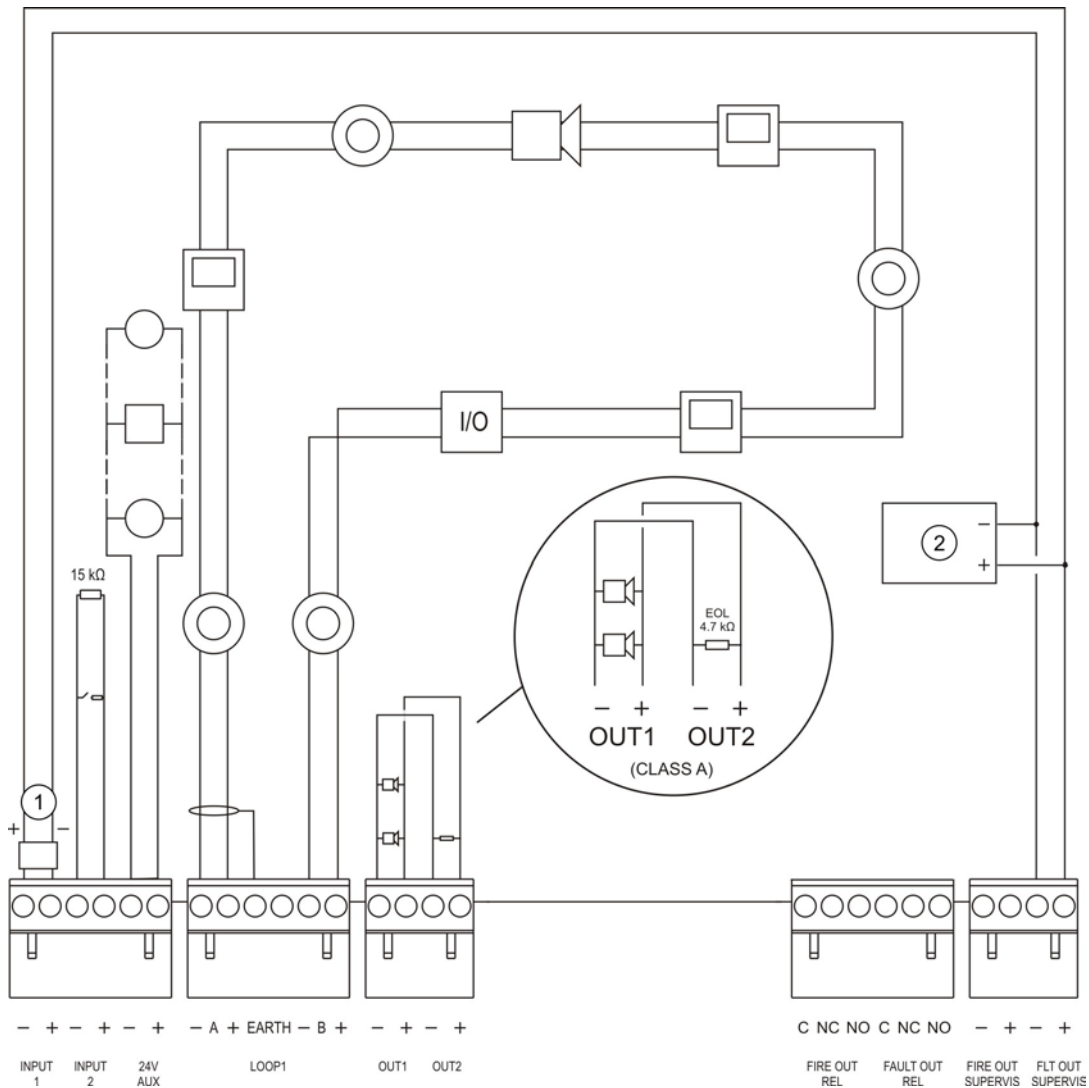

1. 2010-FS-EOL end-of-line device
2. Fault indicating equipment

## Connecting loops

### Loop guidelines

For best results, follow these guidelines when connecting loops:

- Install at least one isolator per loop (we recommend one for every 32 devices).
- Keep loop cabling away from high-voltage cables (or any other source of interference).
- Star, stub, and T-tap configurations are not recommended.
- Install loop devices with a high current consumption as close as possible to the control panel.





## Connecting loop devices

Each loop can support up to 127 devices (using the address range 1 to 127). For detailed loop device installation information, see your device installation sheet.

## Connecting inputs

### Input functionality

Each control panel has two supervised inputs, marked INPUT1 and INPUT2. For input configuration, see “Field configuration” on page 74.

### Connecting inputs

Connect input switches to INPUT1 and INPUT2, as shown in Figure 12 on page 25. For input supervision (open and short circuit), install a 15 k $\Omega$  resistor.

If an input is not used, the 15 k $\Omega$  end-of-line resistor must be installed across the unused terminals to avoid an open circuit fault on the input.

### Input activation characteristics

Input activation characteristics are shown in the table below.

**Table 10: Input activation characteristics**

State	Activation value
Active	$60.2 \Omega \leq \text{active value} \leq 8 \text{ k}\Omega$
Normal	$10 \text{ k}\Omega \leq \text{value} \leq 20.2 \text{ k}\Omega$
Short circuit	$\leq 60.2 \Omega$
High impedance fault	$8 \text{ k}\Omega < \text{value} < 10 \text{ k}\Omega$
Open circuit	$\geq 20.2 \text{ k}\Omega$

## Connecting outputs

Control panel outputs are shown in the table below.

**Table 11: Control panel outputs**

Output	Description	Supervision
24V AUX	Used to supply power to auxiliary equipment. The output can be configured as resettable and to shut down when there is no mains power.	Short circuit, voltage level
OUT1, OUT2, etc.	Configurable outputs (the default configuration is sounder output). The number of configurable outputs depends on the control panel model (see the topic below).  <b>Note:</b> These outputs comply with EN 54-13 requirements when configured as Class A outputs.	Short circuit, open circuit

Output	Description	Supervision
FIRE OUT SUPERVIS [1]	This fire output is activated when the control panel is in alarm status.  <b>Note:</b> This output does not comply with EN 54-13 requirements.	Short circuit, open circuit
FIRE OUT RELAY	This relay output is activated (a short circuit between the common (C) and normally open (NO) terminals of the relay) when there is an alarm.	Not supervised
FAULT OUT SUPERVIS [1]	This fault output is activated when the control panel is not reporting a fault.  <b>Note:</b> This output complies with EN 54-13 requirements when the 2010-FS-EOL end-of-line device is installed.	Short circuit, open circuit
FAULT OUT RELAY	The fault relay output is activated (a short circuit between the common (C) and normally open (NO) terminals of the relay) when there is no fault.	Not supervised

[1] For activation voltage, see Chapter 5 “Technical specifications” on page 109.

### Output termination

All outputs (except the 24V AUX output) must be terminated. Termination requirements are shown in the table below.

**Table 12: Termination requirements**

Output Class	Output termination
Class B (for typical installations)	15 kΩ
Class A (for EN 54-13 installations)	4.7 kΩ [1]

[1] Installed in parallel with one of the output terminals. See Figure 13 on page 26.

If an output is not used, the 15 kΩ end-of-line resistor must be installed across the unused terminals to avoid an open circuit fault on the output. Unused outputs must be configured as Class B.

End-of-line components for outputs are included in the accessory kit provided with your control panel.

**Note:** Output termination differs for typical and EN 54-13 installation types. Take care to install the correct termination for your installation.

### Output polarity

All outputs are polarity sensitive. Observe polarity or install a 1N4007 diode or equivalent to avoid inverted activation issues due to reverse polarity supervision.

### Connecting auxiliary equipment

Connect auxiliary equipment to 24V AUX as shown in Figure 12 on page 25.

## Configurable outputs

The number of configurable outputs depends on the control panel model and output class configuration, as shown below.

**Table 13: Configurable outputs for panels [1]**

Control panel	Configurable outputs (Class B)	Configurable outputs (Class A)
One-loop panel	2 (OUT1 and OUT2)	1 (OUT1/OUT2)
Two-loop panel	4 (OUT1 to OUT4)	2 (OUT1/OUT2 and OUT3/OUT4)
Two-loop panel with loop expansion board	8 (OUT1 to OUT8)	4 (OUT1/OUT2, OUT3/OUT4, OUT5/OUT6, and OUT7/OUT8)

[1] Repeater panels have no configurable outputs.

Configurable options for each output are:

- Sounder output (default setting)
- Fire routing output
- Fire protection output
- Program options
- Fire output
- Fault output

For output configuration see “Field configuration” on page 74.

### Connecting configurable outputs

Connect Class B configurable outputs as shown in Figure 12 on page 25.

Connect Class A configurable outputs as shown in Figure 13 on page 26.

When connecting sounders or beacons, use only those included in the compatibility sheet supplied with your control panel.

### Connecting fire and fault outputs

Connect the FIRE OUT SUPERVIS and FAULT OUT SUPERVIS outputs as shown in Figure 12 on page 25. A 15 k $\Omega$  end-of-line resistor is required.

## Connecting the mains power supply

---

**Caution:** Connect the mains power supply before connecting the batteries.

---

The control panel can be operated at 110 VAC 50/60 Hz or 240 VAC 50/60 Hz (+10%/–15%).

Mains power should be sourced directly from a separate circuit breaker in the building electrical supply distribution board. This circuit should be clearly marked, should have a bipolar disconnect device, and should only be used for fire detection equipment.

Feed all mains cables through the appropriate cable knockouts and connect them to the fuse terminal block as shown in Figure 15 on page 31.

Keep mains cables separate from other cabling to avoid potential short circuits and interference. Use the provided cable ties to secure mains cables to the cabinet on either side of the fuse terminal block to prevent movement.

**Caution:** If the control panel has a network board installed, the mains cable must enter the cabinet from the bottom for proper operation.

**Figure 15: Connecting the mains power supply**

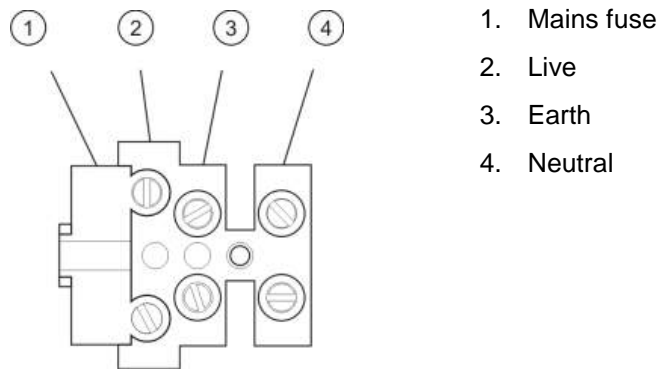

For fuse specifications, see Chapter 5 “Technical specifications” on page 109.

### Selecting 115 or 230 VAC operation

**Caution:** An incorrect power setting can damage the power supply. Always disconnect the control panel from the mains supply before changing the power setting.

The default power setting is 230 VAC. For 115 VAC operation use a small screwdriver to change the power setting switch, located on the side of the power supply unit, as shown in Figure 16 below.

**Figure 16: Selecting 115 or 230 VAC operation**

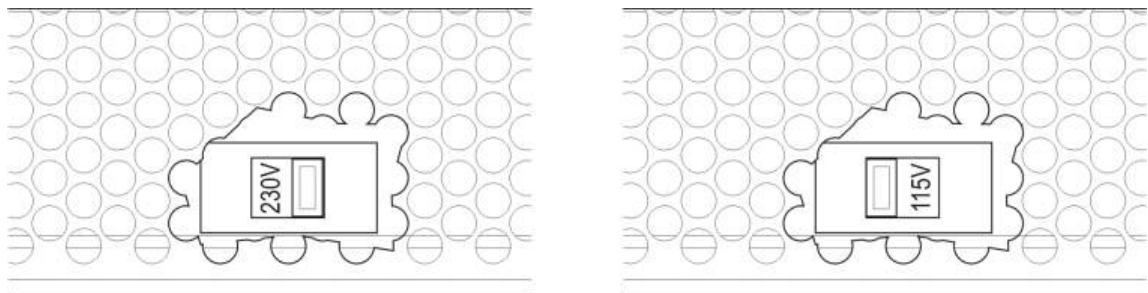

## Connecting the batteries

The control panel requires two 12 V, rechargeable, sealed lead-acid batteries with 7.2, 12, or 18 Ah capacity (see “Battery maintenance” on page 107).

Batteries are located inside the control panel cabinet and must be installed in series. Polarity must be observed.

Connect batteries to the BAT connector on the control panel PCB. No other equipment may be connected to the BAT connector.

**Note:** If the control panel indicates a Supply Fault, then the batteries may need to be replaced.

## Connecting expansion boards

---

**Caution:** Always disconnect the control panel from the mains power supply before installing an expansion board.

---

See your expansion board installation sheet for detailed installation information.

## Connecting a fire network

**Note:** See your network board installation sheet for detailed installation and connection information.

Each network board has two ports. Each port is connected (point to point) to the corresponding ports of the network board in another control panel.

Figure 17: Network board connections

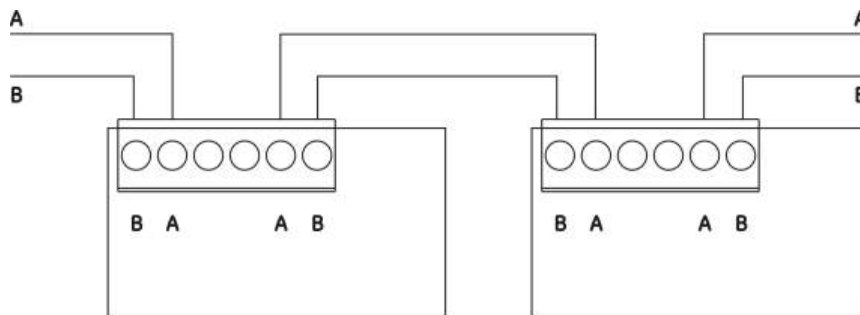

Two wiring options are possible:

- Ring configuration
- Bus configuration

### Ring configuration

Ring network configuration is recommended as it provides for redundancy in the transmission path.

For ring configuration (class A), use both ports to connect all network boards or control panels to form a ring, as shown below.

**Figure 18: Fire network ring configuration**

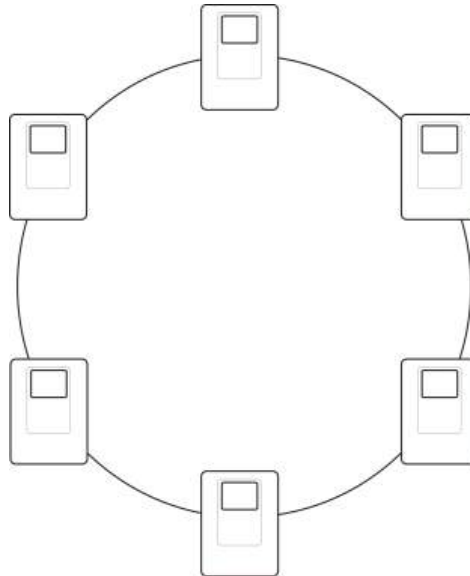

### Bus configuration

**Caution:** Use bus network configuration only in cases where the detection zones and mandatory EN 54-2 output functions (sounder and fire routing outputs) are not remote between panels.

Bus network configuration is not recommended. It does not provide for redundancy in the transmission path and creates a fire network much more sensitive to faults.

For bus configuration (Class B), connect control panels as shown below.

**Figure 19: Fire network bus configuration**



## Connecting an external printer or ASCII terminal

To print control panel events in real time, connect an external EPSON LX300 printer or ASCII terminal to COM0 or COM1.

**Note:** This option requires the 2010-2-232-KIT (not supplied). The kit contains a 3 m cable and the 2010-2-232-IB isolation board required for external RS-232 device connections.

Serial port connections for each output type are shown below.

**Table 14: Serial port connections**

Serial port	Output device
COM0	EPSON LX300 printer
COM1	ASCII terminal

See Figure 4 on page 17 for COM serial port and RS-232 interface board connector locations.

See “Printer configuration” on page 69 for configuration options.



# Chapter 3

## Configuration and commissioning

### Summary

This chapter provides configuration and commissioning information for your control panel and fire detection system.

### Content

Introduction	36	Field configuration	74
User levels	36	Autosetup	74
Configuration overview	37	Loop device configuration	75
Maintenance level operation and configuration	40	Zone configuration	75
The Panel setup menu	40	Panel I/O configuration	83
The Communications menu	44	Activation configuration	91
The Disable/Enable menu	45	Loop Class configuration	99
The Test menu	46	Tests	99
The Reports menu	49	Password setup	100
The Password setup menu	52	Commissioning	102
Installer level operation and configuration	53		
The Main menu	53		
Panel configuration	53		
ID configuration	54		
Regional options	55		
Firenet configuration	55		
Communications configuration	59		
Other settings	61		
Load/Save configuration	64		
Expansion board configuration	66		
Load auxiliary files	67		
Firmware updates	68		
Printer configuration	69		
DACT configuration	69		

# Introduction

## User levels

Access to some of the features of this product is restricted by the user level assigned to a user account.

### Public

The public level is the default user level.

This level allows basic operational tasks, such as responding to a fire alarm or fault warning at the control panel. No password is required.

Operational tasks for this user level are described in the product operation manual.

### Operator

The operator level allows additional operational tasks and is reserved for authorized users who have been trained to operate the control panel. The default password for the default operator user is 2222. Operational tasks for this user level are described in the product operation manual.

### Maintenance

The maintenance level allows routine maintenance tasks and is reserved for authorized users who have been trained to operate and maintain the control panel and fire system. The default password for the default maintenance user is 3333.

### Installer

The installer level allows full system configuration and is reserved for authorized users installing and configuring the control panel and fire system. The default password for the default installer user is 4444.

### Restricted user levels

Restricted user levels are protected by password security. You are required to enter the username and password assigned to you.

The control panel automatically exits from a restricted user level and reverts to the public user level after a few minutes if no button is pressed. The automatic timeout period depends on the active user level, as shown below.

**Table 15: User level timeouts**

User level	Automatic timeout period
Operator	2 minutes
Maintenance	10 minutes
Installer	10 minutes

**To enter a password-protected level:**

1. Press F4 (Main menu). The username and password prompt appears on the LCD.
2. Select your username and enter your password by turning the jog dial clockwise or anticlockwise. Press the jog dial to confirm each entry.

When a correct four-digit password has been entered, the LCD displays the Main menu for your assigned user level.

**Note:** The control panel can be configured to remember the last login details entered. See “Secure access” on page 102 for more information.

**To exit from a password-protected level:**

1. Press F3 (Logout) from the Main menu.

## Configuration overview

### PC-based configuration

For best results we recommend that the control panel and fire system is configured using our Configuration Utility software application.

Benefits of using the Configuration Utility include:

- New configurations can be prepared in advance of installation and applied to the control panel and fire system quickly and easily at the site
- Current configuration files can be saved directly to a USB flash drive and modified in the Configuration Utility
- Advanced programming of rules to generate actions is available

A rule consists of one or more states (combined by Boolean operators) that are configured to trigger specific system actions after a specific confirmation time.

An action is the activation of output groups or the execution of programmable commands in the system.

Rules programming is also known as cause and effect programming, I/O logic activation, etc.

When configuring your fire system using the Configuration Utility:

1. Configure the communications settings if you plan to download configurations using an Ethernet connection. This is not required if you plan to save configurations to a PC connected to the control panel USB connector.
2. Configure the date and time at the control panel and load the configuration as described in “Loading and saving configuration files” on page 65.

For more information on the Configuration Utility, contact your local distributor.

### Control panel configuration recommendations

Use the control panel configuration wizards to guide you through the configuration process for most applications.

To access the configuration wizards press F1 (Wizards) from the installer level Main menu.

In general we recommend the following configuration order:

1. Control panel configuration (date and time, expansion boards, control panel ID and description, fire network, and communications). For more information, see “Panel configuration” on page 53.
2. Field configuration (loop devices, zones, and control panel inputs and outputs). For more information, see “Field configuration” on page 74.
3. Change all default passwords for increased security. For more information, see “Changing your password” on page 100.

### Configuration controls

Use function buttons F1 to F4 and the jog dial (see Figure 3 on page 10) to navigate the LCD menu, to select menu options, and to enter passwords and system information, as shown below.

Entering passwords and system information	Turn the jog dial clockwise or anticlockwise to enter passwords and other system information. Press the jog dial to confirm an entry.
Selecting soft keys from the LCD menu	Press the function buttons F1 to F4 to select the corresponding menu options (Main menu, Logout, Exit, etc.).
Navigating and confirming menu selections	Turn the jog dial clockwise or anticlockwise to select an option from the on-screen menu. Press the jog dial to confirm the selection.

The control panel ID on the LCD is white text with a dark background when the jog dial is active (the control panel is waiting for input).

## Configuration options

The options listed below are available when making configuration changes to the control panel.

The control panel configuration (and configuration revision) is only updated when configuration changes are applied by pressing F3 (Apply).

The configuration revision change and timestamp are recorded in the Revision report and can be accessed at operator, maintenance, and installer levels.

**Table 16: Configuration control options and keys**

Option	Key	Description
Save	F1	Saves the current configuration change without applying it immediately.
Apply	F3	Applies the current configuration change and all stored (saved) configuration changes. The control panel resets automatically.
Discard	F4	Discards all stored (saved) configuration changes that have not been applied.
Exit	F2	Exits the configuration process without storing or applying the current configuration change.

**Note:** When updating multiple configuration settings, we recommend that you save after each change, and then apply all changes from the Main menu.

## Maintenance level operation and configuration

The maintenance level is password-protected and is reserved for authorized users trained to operate the control panel and perform routine maintenance tasks for the fire system. The default password for the default maintenance user is 3333.

The maintenance level lets you:

- Perform all operator level tasks described in the operation manual
- Change the control panel time and date and synchronize the time and date in a fire network
- Change the day/night mode time and holiday calendar settings (fire alarm control panels only)
- Change the TCP/IP, email, and USB communications settings
- Back up or clear the event log
- View and save reports
- Disable or enable system features or loop devices
- Test zones, inputs, outputs (including output groups), and batteries
- Change the user passwords
- Locate devices
- Activate service mode for testing purposes

### The Main menu

The maintenance level Main menu is shown below.

Figure 20: Maintenance level Main menu



### The Panel setup menu

Use the Panel setup menu to set the date and time, to synchronize the date and time in a fire network, and to set day or night mode sensitivity settings.

#### Date and time

Select the Date and time option to change the control panel date and time.

#### To change the date and time:

1. Select Panel setup from the Main menu.



2. Select Date and time.
3. Enter the date using the format DD/MM/YY (for example, 10/06/09).
4. Enter the time using the format hh:mm:ss (for example, 15:03:25).
5. If required, select YES for Firenet time sync to synchronize the date and time across all control panels in a fire network.
6. Press F4 (Enter), and then press F1 (Back).
7. Press F2 (Exit) to exit the menu.

### Day/night mode sensitivity settings

Select the Day/Night mode option to change selected day/night fire detection and response criteria based on preconfigured time settings, as shown below.

**Note:** This option is not available on repeater panels.

**Table 17: Day/night mode settings and icons**

Mode	LCD icon	Description
Day		In this mode an automatic fire alarm (an alarm activated by a detector) activates sounders and fire routing (if enabled) after any configured delay. Subject to configuration, detectors may use a reduced sensitivity setting.
Night		In this mode an automatic fire alarm (an alarm activated by a detector) activates sounders and fire routing (if enabled) immediately and bypasses any configured delay. Subject to configuration, detectors may use an increased sensitivity setting.

The LCD icon confirming the current mode is displayed on the LCD and indicates whether the setting applies only to the local control panel or is a general setting for all control panels in the fire network. For more information on LCD indications, see “LCD controls and indicators” on page 10.

### Setting the day/night schedule

Select the Day/Night schedule option to configure weekly schedules for day and night mode settings.

#### To set a day/night schedule:

1. Select Panel setup from the Main menu.
2. Select Day/Night mode, and then select Day/Night schedule.
3. Select the day you want to configure.
4. Enter the time that day mode starts using the hh:mm format (for example, 08:00).
5. Enter the time that night mode starts using the hh:mm format (for example, 21:00).
6. Press F4 (Enter), and then press F1 (Back).

7. Press F1 (Save), F3 (Apply), F4 (Discard), or F2 (Exit).

Remember to apply saved settings from the Main menu.

**Note:** To avoid changing to day mode, set the day mode start time to 24:00. To avoid changing to night mode, set the night mode start time to 24:00.

Here are two examples of day/night mode scheduling.

To start day mode at midnight and end at 06:00, set the day mode start time to 00:00 and the night mode start time for the same day to 06:00.

To start night mode at 22:00 and end at midnight, set the night mode start time for the day to 22:00 and the day mode start time for the following day to 00:00.

### Setting the holiday calendar

Select the Holiday calendar option to configure a day or night mode setting for a range of dates.

#### To configure day/night mode for dates:

1. Select Panel setup from the Main menu.
2. Select Day/Night mode, and then select Holiday calendar.
3. Select F3 (New) to enter a new holiday period or select an existing holiday period from the displayed list.

To delete an existing holiday period, press F4 (Delete).

4. Enter the start date and the end date for the holiday sensitivity setting. The date format is DD/MM (for example, 29/11 for 29 November).
5. Select the sensitivity mode (day or night) for the holiday period. The default setting is night mode (it is assumed that there are no people on site during the holiday period).
6. Enter any additional holiday periods as described in steps 3 and 4.
7. Press F4 (Enter), and then press F1 (Back).
8. Press F1 (Save), F3 (Apply), F4 (Discard), or F2 (Exit).

Remember to apply saved settings from the Main menu.



## Additional day/night mode settings

Select the Day/Night setup option to configure additional settings such as manual override of day/night mode schedule and holiday calendar mode changes or delay behaviour in night mode.

The configuration options available are shown in the table below.

**Table 18: Additional day/night mode options**

Option	Description
Manual	Configures the control panel to process or override day/night mode change commands from the day/night mode schedule or the holiday calendar
Mode	Configures the default day/night mode setting for the control panel if Manual (above) is set to YES
Disable delays in night mode	Configures the control panel to process or override sounder, fire routing, and fire protection delays when the control panel is in night mode.

### To change the configuration:

1. Select Panel setup from the Main menu.
2. Select Day/Night mode, and then select Day/Night setup.
3. Select Manual, and then select NO (to process mode change commands from the day/night mode schedule and holiday calendar) or YES (to override mode change commands from the day/night mode schedule and holiday calendar).

The default setting is NO (mode change commands from the Day/Night mode schedule and Holiday calendar are processed as configured).

4. Select Mode, and then select DAY or NIGHT to define the default control panel sensitivity mode if Manual (above) is set to YES.

The default setting is DAY. If Manual is set to NO, then no mode configuration is required.

5. Select Disable delays in night mode, and then select which sounder, fire routing, or fire protection delays to process or override when the control panel is in night mode.

By default, all delays are disabled when the control panel is in night mode.

6. Press F4 (Enter), and then press F1 (Back).
7. Press F1 (Save), F3 (Apply), F4 (Discard), or F2 (Exit).

Remember to apply saved settings from the Main menu.

## Notes on day and night mode settings

Day/night mode may be configured to change with a remote input. Depending on the installation settings, the system may be configured to use an external input to override the day/night mode setting until the following programmed change (if any).

Control panels in the same network can have different day/night mode sensitivity settings.

If the command filter is configured accordingly, a control panel can operate a local day/night mode setting independently from other control panels in the same network. A local day/night mode setting is indicated on the local control panel LCD by the corresponding icon. See “Icons displayed on the LCD” on page 11.

If the control panel is a repeater, remember that the day/night mode displayed corresponds to those control panels configured to accept the global sensitivity mode command. Some control panels in the network may be operating with locally-defined sensitivity settings.

The day/night mode setting for all control panels in a fire network is included in the Firenet status report.

For more information on the global controls, see “Global controls” on page 57.

## The Communications menu

Use the Communications menu to set up email accounts for event notifications and to safely remove a USB device connected to the control panel.

### Managing email accounts

Select the Email accounts option to manage the email accounts for remote monitoring and to configure the types of events sent to each email address.

#### To configure email accounts:

1. Select Communications from the Main menu.
2. Select Email accounts, and then select the account to be edited (the default names are Account 1, Account 2, etc.).
3. Select the types of events to be included in the notification email: alarms, faults, conditions, or log events (any other system status change event).  
If no event type is selected, the email notification service is not activated.
4. Enter the email address associated with the email account.
5. Press F4 (Enter), and then press F1 (Back).
6. Press F1 (Save), F3 (Apply), F4 (Discard), or F2 (Exit).

Remember to apply saved settings from the Main menu.

**Note:** This feature requires TCP/IP and email server details to be configured.

## Removing a USB device

Select the Remove USB device option to safely remove a USB device connected to the control panel (for example, a flash drive).

---

**Caution:** Failure to remove a USB flash drive as described may result in loss of data and/or damage to your flash drive.

---

### To remove a USB device:

1. Select Panel setup from the Main menu, and then select Communications.
2. Select Remove USB device. A message displays on the LCD confirming the operation.
3. Press F2 (Exit) to exit the menu.
4. Open the control panel door and remove the flash drive.

## The Disable/Enable menu

Use the Disable/Enable menu to disable and enable the system features and devices. Features and devices can be disabled remotely if the control panel is part of a fire network. Disabled features and devices do not indicate faults or fire alarms.

**Note:** Changes to disable/enable configuration at this user level are not stored in the control panel configuration and are not included in any saved configuration files.

The following features or devices can be disabled or enabled from this menu:

- Zones
- Devices
- Control panel inputs and outputs
- Output groups (sounder, fire routing, fire protection, or program)

### Disabling a system feature or device

#### To disable a feature or device:

1. Select Disable/Enable from the Main menu.
2. Select Disable (or Remote Disable if the feature or device is not local to the control panel).
3. Select the corresponding option (zones, devices, etc.).
4. For local disablements, select the feature or device to be disabled, and then press the jog dial to confirm the disablement.

For remote disablements, enter the Firenet ID of the feature or device to be disabled, and then press the jog dial to confirm the disablement.

5. Press F2 (Exit) to exit the menu.

Repeat to enable a disabled feature or device.

### Notes

- Active outputs cannot be disabled.
- Devices or zones in alarm are not disabled until the control panel is manually reset.
- In maintenance level operation, to disable Class A outputs each output used must be disabled (for example, if OUT1 and OUT2 are combined to create a single Class A output, then both OUT1 and OUT2 must be disabled individually).

## The Test menu

Use the Test menu to test system features or devices. The following features or devices can be tested from this menu:

- Zones
- Control panel input activation
- Control panel and loop output activation
- Output group activation
- Device LED activation
- Remote features and devices
- Batteries

**Note:** Tests for outputs and output groups (local or remote) continue for as long as the test screen is visible. There is no automatic timeout for the output activation test and system information will not be visible on the LCD for the duration of the test. Operation not related to the activation test continues as normal in the background.

### Testing zones

#### To test a zone:

1. Select Test from the Main menu.
2. Select Zones.
3. Select the zone to test, and then press the jog dial to start the test. Press the jog dial again to end the test for the selected zone.

You can select and test up to a maximum of four zones to test at the same time.

4. Press F2 (Exit) to exit the menu.

Repeat the above steps to end the zone test.

When an alarm is activated in a zone in test:

- The zone test is confirmed on the LCD while the alarm is active
- If a zone board is installed and the corresponding zone is included on the zone board, then the zone alarm LED is flashing or steady (depending on the source of the alarm)
- Fire routing, fire protection, sounders, and programmable activations are not activated
- The control panel resets the initiating device after 5 seconds and clears the alarm (manual call points must first be closed before an automatic reset can be applied)
- The event is recorded in the event log

When there is a fire alarm in any zone that is *not* in test, the control panel responds to the alarm event as configured.

### **Testing control panel input activation**

#### **To test activation of an input:**

1. Determine the input functionality (consult your fire system installation details).
2. Select Service mode from the Test menu, and then select Local or Global.

Service mode ensures that outputs are not accidentally activated during input tests. Set Service mode to Global to avoid local and network output activation. For more information, see “Service mode” on page 49.

3. Activate the input device according to the device instructions.
4. Check that the control panel reports the input activation as expected (this depends on the input configuration, device type, etc.).

When the test is complete, reset the control panel and exit service mode.

### **Testing control panel and loop output activation**

#### **To test activation of an output:**

1. Select Test from the Main menu.
2. Select Output test from the Test menu, and then select Panel outputs or Loop outputs.
3. Select the output you want to test, and then select YES (to activate the output) or NO (to deactivate the output).
4. Press the jog dial again to end the test.
5. Press F2 (Exit) to exit the menu.

## Testing output group activation

### To test output group activation:

1. Select Test from the Main menu, and then select Output group.
2. Select the ID of the output group you want to test, and then select YES (to activate the output group) or NO (to deactivate the output group).
3. Press the jog dial again to end the test.
4. Press F2 (Exit) to exit the menu.

## Locating devices

Select the Locate device option to activate a loop device LED. This helps to identify the location of a device in the installation. You will need the Firenet ID of any remote device LED to be activated.

### To locate a device:

1. Select Test from the Main menu, and then select Locate device.
2. Select the loop number, All loops, or Remote (if Remote is selected, enter the Firenet ID, loop number, and device address when prompted).  
A list of all the devices on the selected loops is displayed.
3. Select the corresponding device, and then press the jog dial to activate the device LED. To turn off the device LED, press the jog dial again.
4. Press F2 (Exit) to exit the menu.

## Testing remote features or devices

Select the Remote test option to test remote features or devices. You will need the Firenet ID of the remote feature or device to be tested.

### To test remote features or devices:

1. Select Test from the Main menu, and then select Remote Test.
2. Select Panel and enter the control panel Firenet ID.
3. Select Element, and then select Device, Group, or Zone. Enter the device loop and address information, the group number, or the zone number.  
For devices enter the loop number and the device address in the format L.DDD (for example, 1.089 for device 89 on loop 1).
4. Select Active then select YES (to start the test) or NO (to stop the test).
5. Press the jog dial again to end the test.
6. Press F2 (Exit) to exit the menu.

## Testing batteries

Select the Battery test option to test the batteries. For more information on battery status messages, see “Battery maintenance” on page 107.

### To test the batteries:

1. Select Test from the Main menu.
2. Select Battery test.

A message confirming battery status displays on the LCD.

3. Press F2 (Exit) to exit the menu.

## Service mode

Select the Activate service mode option to avoid accidental activation or deactivation of outputs or output groups (local or remote) during tests.

In this mode the control panel indicates and logs activation events as configured but does not activate or deactivate the corresponding output. This can be used to verify control panel event configuration and to verify that outputs are not activated accidentally.

**Note:** An automatic timeout for Service mode may be configured at Installer level. See “Service mode timeout” on page 64.

To activate service mode:

1. Select Test from the Main menu, and then select Service mode.
2. Select Activate service mode, and then select YES (to activate service mode) or NO (to deactivate service mode).
3. Select Global, and then select YES (to activate service mode across the network) or NO (for local testing only).
4. Press F2 (Exit) to exit the menu.

Remember to exit service mode when all tests are completed.

## The Reports menu

Use the Reports menu to view, clear, or back up the event log and to display a variety of system status reports. The reports available to maintenance users are shown in the table below.

**Table 19: Reports available to maintenance users**

Report	Description
Event log	Displays, clears, or backs up the event log. The event log contains all the alarm, fault, and condition events recorded by the control panel.
Attention required	Displays all devices reporting a fault condition.
Revision	Displays your control panel software revision, control panel configuration revision, and system boards serial number data.

Report	Description
Contact details	Displays maintenance or installation contractor contact information (subject to installer configuration).
Zone status [1]	Displays the current status information for zones.
Zone mapping [1]	Displays which devices are assigned to each zone in your fire system.
Device status [1]	Displays the current status information for control panel devices. Device information available in real time includes: instant, mean, maximum, and minimum analog values, alarm level, and communication error rate.
Panel I/O status	Displays the current status information for the control panel inputs and outputs.
Output Groups status [1]	Displays the control panel output groups (sounders, fire routing, fire protection, or program) that are currently active.
Rules status	Displays the control panel rules that are currently active. A rule consists of one or more states (combined by Boolean operators) that are configured to trigger specific system actions after a specific confirmation time. Rules are created using the configuration utility.
Firenet status	Displays the current status for all control panels in the fire network.
Save reports	Saves reports.

[1] These reports are not available for repeater panels.

### Viewing or clearing the event log

Select the View all option or the Clear option to view or clear alarm, fault, and condition events logged by the control panel.

#### To view or clear the event log:

1. Select Reports from the Main menu.
2. Select Event log, and then select View all (to view all current entries) or Clear (to delete all current entries).
3. Press F2 (Exit) to exit the menu.

The event log can include a maximum of 9,999 entries. When the maximum number of entries is reached, the oldest entries are deleted as new entries are recorded.

### Backing up the event log

Select the Backup option to create a backup of the event log. The backup reports are saved to a USB flash drive (not supplied) in XML format and can be viewed with the Configuration Utility.

#### To back up the event log:

1. Open the control panel cabinet door.
2. Insert a USB flash drive into either of the USB connectors (Figure 21, item 1).
3. Close the control panel cabinet door.



4. Select Reports from the Main menu.
5. Select Event log, and then select Backup.
6. Follow the on-screen instructions.
7. Press F2 (Exit) to exit.
8. Remove the flash drive as described in “Removing a USB device” on page 45.

**Note:** If your flash drive is not recognized by the control panel, reformat it as FAT32 from a PC and try again. If the problem persists, try a different flash drive.

**Figure 21: USB connectors on the control panel PCB**

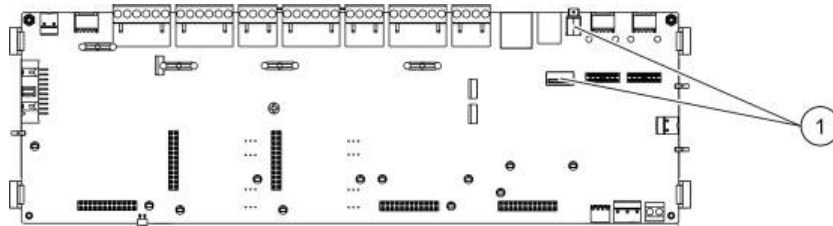

1. USB connectors

### Saving reports

Select the Save report option to save a report. Reports are saved to a USB flash drive (not supplied) in XML format and can be viewed with the configuration utility PC application.

#### To save a report:

1. Open the control panel cabinet door.
2. Insert a USB flash drive into either of the USB connectors.
3. Close the control panel cabinet door.
4. Select Reports from the Main menu.
5. Select Save report, and then select ALL or the report to be saved.
6. Press F2 (Exit) to exit.
7. Remove the USB flash drive as described in “Removing a USB device” on page 45.

## The Password setup menu

Use the Password setup menu to change your maintenance password and to manage operator user accounts.

### Changing your password

Select the Change password option to change your password. You cannot change passwords for other maintenance users.

#### To change your password:

1. Select Password setup from the Main menu, and then select Change password.
2. Enter your current password.
3. Enter and then confirm your new password.
4. Press F4 (Enter), and then press F1 (Back).
5. Press F1 (Save), F3 (Apply), F4 (Discard), or F2 (Exit).

Remember to apply saved settings from the Main menu.

### Managing users

Select the Manage users option to edit, delete, or create operator user accounts. The control panel allows for a maximum of 20 user accounts (all user levels combined).

#### To edit an operator user account:

1. Select Password setup from the Main menu, and then select Manage users.  
A list of the user accounts that you have permission to edit is displayed.
2. Select the user account you want to edit.
3. Select the information to be edited and enter the change.  
To change the operator user password, re-enter your maintenance user password, and then allocate and confirm the new operator password.
4. Press F4 (Enter), and then press F1 (Back).
5. Press F1 (Save), F3 (Apply), F4 (Discard), or F2 (Exit).

Remember to apply saved settings from the Main menu.

#### To delete an operator user account:

1. Select Password setup from the Main menu, and then select Manage users.  
A list of the user accounts that you have permission to edit is displayed.
2. Select the user account you want to delete.  
You cannot delete the default operator user account.
3. Press F4 (Delete) to delete the selected account.

4. Press F4 (Enter), and then press F1 (Back).
5. Press F1 (Save), F3 (Apply), F4 (Discard), or F2 (Exit).

Remember to apply saved settings from the Main menu.

**To create a new operator user account:**

1. Select Password setup from the Main menu, and then select Manage users.
2. Press F3 (New) to create a new account.
3. Enter a username and a password for the new account.

Usernames help to identify user session activity in the event log.

4. Press F4 (Enter), and then press F1 (Back).
5. Press F1 (Save), F3 (Apply), F4 (Discard), or F2 (Exit).

Remember to apply saved settings from the Main menu.

## Installer level operation and configuration

The installer level is password-protected and is reserved for authorized users installing and configuring the control panel and the fire system. The default password for the default installer user is 4444.

### The Main menu

The installer level Main menu is shown below.

**Figure 22: The installer level Main menu**



### Panel configuration

Use the Panel setup menu to access the control panel configuration options shown below.

**Table 20: Control panel configuration**

Option	Description
ID configuration	Configures the control panel Firenet ID (for the fire network) and description. The description is displayed on the LCD when the control panel is in standby.

Option	Description
Date and time	Configures the control panel date and time, and to synchronize the date and time in a fire network. See "Date and time" on page 40.
Day/Night mode	Configures the sensitivity settings for the day/night schedule and for the holiday calendar. See "Day/night mode sensitivity settings" on page 41.
Regional options	Configures the control panel's regional operation mode.
Firenet	Configures the control panel fire network.
Communications	Configures TCP/IP communication settings, to manage email accounts (for event notifications), and to safely remove a USB device.
Other settings	Configures general panel settings, including 24V AUX output, fault mask, sounder re-sound, school bell settings, etc.
Load/Save configuration	Loads a new configuration, saves the current configuration file to a USB flash drive, restores the previous configuration, or restores the default factory settings.
Expansion boards	Configures any installed expansion boards.
Load auxiliary files	Loads auxiliary files from a USB flash drive. Auxiliary files that can be loaded include custom standby and alarm screens, and updated language or font files for extended language support.
Firmware update	Loads control panel firmware updates.
Printer configuration	Configures external and internal printer settings.
DACT configuration	Configures Ethernet, central monitoring station, PSTN, and GPRS settings for an installed DACT board.

## ID configuration

Select the ID configuration option to configure the control panel Firenet ID (for the fire network) and description. The ID must be in the range 01 to 32. The default ID is 01.

### To change the ID or description:

1. Select Panel setup from the Main menu.
2. Select ID configuration.
3. Enter the ID and description.
4. Press F4 (Enter), and then press F1 (Back).
5. Press F1 (Save), F3 (Apply), F4 (Discard), or F2 (Exit).

Remember to apply saved settings from the Main menu.

## Regional options

Select Regional options to set the regional operating mode. Available options are shown in the table below.

**Table 21: Regional operating modes**

Operating mode	Region
EN 54-2 (default)	European Union
EN 54-2 Evacuation	European Union (Spain)
NBN S 21-100 [1]	European Union (Belgium)
NEN 2535/2575 [2]	European Union (Holland)
VdS 2540 [1]	European Union (Germany)

[1] See the corresponding marketplace manuals for additional installation and operation instructions for these regional operating modes.

[2] Implements NEN 2535 for fire and repeater panels and NEN 2575 for evacuation panels.

### To change the control panel operation mode:

1. Select Panel setup from the Main menu.
  2. Select Regional options.
  3. Select the operating mode.
  4. Press F4 (Enter), and then press F1 (Back).
  5. Press F1 (Save), F3 (Apply), F4 (Discard), or F2 (Exit)
- Remember to apply saved settings from the Main menu.

## Firenet configuration

Select the Firenet options to configure the control panel fire network and repeater settings shown in the table below.

**Table 22: Firenet configuration options**

Option	Description
Firenet map	Displays all detected control panels, to add control panels to the fire network, or to remove control panels from the network. By default new control panels detected do not communicate with the network.
Firenet opmode	Configures the control panel network operation mode (stand-alone panel, networked panel, or networked repeater panel).
Repeater map	Configures the control panels in the network that the control panel being configured will repeat.
Global controls	Configures global control options for networked control panels and repeaters.

Option	Description
Event filter	Configures the types of events to repeat from other control panels in the fire network.
Command filter	Configures the types of commands sent to the fire network in control panels with the corresponding global controls configured.
Class B	Configures a Class B network. When this option is configured, no fault is reported for an open network.

## Firenet map

The Firenet map defines the control panels included in the fire network. If a control panel previously configured to be in the fire network is not detected, a fault message indicating the offline status (with the Firenet ID) is reported.

### To change the Firenet map settings:

1. Select Panel setup from the Main menu.
2. Select Firenet.
3. Select Firenet map.  
A list of detected control panels appears on the LCD.
4. Select the control panel from the list, and then select YES (to add the control panel to the network) or NO (to remove the control panel from the network).
5. Press F4 (Enter), and then press F1 (Back).
6. Press F1 (Save), F3 (Apply), F4 (Discard), or F2 (Exit).

Remember to apply saved settings from the Main menu.

## Firenet opmode

Available network operation modes are shown below.

**Table 23: Firenet operation modes**

Mode	Description
Stand-alone	Configures a stand-alone control panel. This is the default setting for fire alarm control panels.
Networked	Configures a networked control panel. See description below.
Repeater	Configures a networked repeater. This is the default setting for repeater panels. See description below.

In networked mode, the control panel uses the network to process and show the alarm and fault events received from any remote panel which belong to any of the local zones in the system.

In repeater mode, in addition to having the network panel functionality described above, the panel indicates all events for all panels selected to be repeated or as defined by the event filter configuration. For example, if the control panel event

filter has condition and fault reporting disabled, the repeater repeats only alarm, prealarm, alert, and technical alarm conditions.

Therefore, in Repeater mode the panel uses the network:

- To process and display the events received from any remote panel that affect the local zones in the system
- To display any event coming from any of the remote panels present in the repeated panel map (or as defined by the event filter configuration)

#### **To change the network operation mode settings:**

1. Select Panel setup from the Main menu.
2. Select Firenet, and then select Firenet Opmode.
3. Select Standalone, Networked, or Repeater).
4. Press F4 (Enter), and then press F1 (Back).
5. Press F1 (Save), F3 (Apply), F4 (Discard), or F2 (Exit).

Remember to apply saved settings from the Main menu.

A stand-alone panel retains its network node even though it is not communicating with the network.

#### **Repeater map**

The default setting is YES (all control panels in the fire network are repeated).

#### **To change the repeater map settings:**

1. Select Panel setup from the Main menu.
2. Select Firenet, and then select Repeater map.
3. Select the control panel from the list, and then select YES (to repeat the control panel) or NO (to stop repeating the control panel).
4. Press F4 (Enter), and then press F1 (Back).
5. Press F1 (Save), F3 (Apply), F4 (Discard), or F2 (Exit).

Remember to apply saved settings from the Main menu.

#### **Global controls**

Select the Global controls option to allow the control panel to control the fire network (by sending global commands defined by the command filter). The default setting is YES (global commands are allowed).

#### **To change the Global control settings:**

1. Select Panel setup from the Main menu.
2. Select Firenet, and then select Global controls.
3. Select the control panel from the list, and then select YES (to allow global control) or NO (to stop global control).

4. Press F4 (Enter), and then press F1 (Back).
5. Press F1 (Save), F3 (Apply), F4 (Discard), or F2 (Exit).

Remember to apply saved settings from the Main menu.

The commands that can be controlled globally are detailed in Table 24 below.

### Event filter

Select the Event filter option to configure the types of events to repeat from other control panels in the fire network. The control panel always displays alarm and alert events. Fault and condition reporting may also be selected if required.

#### To change the Event filter settings:

1. Select Panel setup from the Main menu.
2. Select Firenet, and then select Event filter.
3. Select the types of events to repeat.
4. Press F4 (Enter), and then press F1 (Back).
5. Press F1 (Save), F3 (Apply), F4 (Discard), or F2 (Exit).

Remember to apply saved settings from the Main menu.

### Command filter

Select the Command filter option to configure the types of commands sent to the fire network in control panels with the corresponding global controls configured.

The commands that can be configured are shown in the table below.

**Table 24: Command filter configuration options**

Command	Description
RST	Reset
PnSilen	Panel silence
SND	Sounder start/stop
SND_DLY	Sounder delay (enable delay or cancel active delay)
FR	Fire routing start/stop
FR_DLY	Fire routing delay (enable delay or cancel active delay)
FP	Fire protection start/stop
FP_DLY	Fire protection delay (enable delay or cancel active delay)
D/N_M	Day/night mode change [1]
UKSB	UK school bell on/off

[1] Used to allow control panels within the network to have locally-defined day/night mode settings. If this setting is not activated, the control panel does not send the day/night mode change and does not process these commands when received from other control panels in the fire network.



**To change the Command filter settings:**

1. Select Panel setup from the Main menu.
2. Select Firenet, and then select Command filter.

A list of available commands that can be configured is displayed.

3. Select all commands to be filtered.
4. Press F4 (Enter), and then press F1 (Back).
5. Press F1 (Save), F3 (Apply), F4 (Discard), or F2 (Exit).

Remember to apply saved settings from the Main menu.

**Class B**

Select the Class B option to configure your fire network class configuration (Class A or Class B). The default setting is NO (Class A network configuration).

**To change the network class settings:**

1. Select Panel setup from the Main menu.
2. Select Firenet, and then select Class B.
3. Select YES (for Class B network) or NO (for Class A network).
4. Press F4 (Enter), and then press F1 (Back).
5. Press F1 (Save), F3 (Apply), F4 (Discard), or F2 (Exit).

Remember to apply saved settings from the Main menu.

## Communications configuration

**TCP/IP**

Default TCP/IP settings are shown in the table below. The control panel MAC address and Host information is also available in this screen if required for troubleshooting purposes.

**Note:** For increased security, we recommend against using Ethernet for remote connection to the control panel via the Internet.

**Table 25: Default TCP/IP settings**

Option	Default value
IP address	192.168.104.140
Subnet mask	255.255.255.0
Gateway	0.0.0.0
Port	2505 [1]

[1] If the default port is changed, the port configuration in the configuration utility PC application must also be updated.

### **To change the TCP/IP settings:**

1. Select Panel setup from the Main menu, and then select Communications.
2. Select TCP/IP.
3. Enter the IP, Subnet mask, Gateway, and Port information.
4. Press F4 (Enter), and then press F1 (Back).
5. Press F1 (Save), F3 (Apply), F4 (Discard), or F2 (Exit).

Remember to apply saved settings from the Main menu.

**Note:** If your network is protected by a firewall, the port configuration in your firewall must be updated to allow local communication with external software.

### **Email accounts**

Select the Email accounts option to manage the email accounts for remote monitoring and to configure the types of events sent to each email address. For correct operation, TCP/IP and email server details must be configured (see “Email server” below).

**Note:** Maintenance users are also able to modify settings for this service.

### **To manage email accounts:**

1. Select Communications from the Main menu.
2. Select Email accounts, and then select the account to be edited (the default names are Account 1, Account 2, etc.).
3. Select the types of events to be included in the notification email: alarms, faults, conditions, or log events (any other system status change event).

If no event type is selected, the email notification service is not activated.

4. Enter the email address associated with the email account.
5. Press F4 (Enter), and then press F1 (Back).
6. Press F1 (Save), F3 (Apply), F4 (Discard), or F2 (Exit).

Remember to apply saved settings from the Main menu.

### **Email server**

Select the Email server option to configure the email server settings for sending configured notification emails. IT support may be required to configure this option.

### **To configure the email server:**

1. Select Panel setup from the Main menu, and then select Communications.
2. Select Email server.
3. Enter the Host (domain) and the IP address of the email server.

The Host name is optional.

4. Press F4 (Enter), and then press F1 (Back).
5. Press F1 (Save), F3 (Apply), F4 (Discard), or F2 (Exit).

Remember to apply saved settings from the Main menu.

## Other settings

### 24V auxiliary

Select the 24V AUX config option to configure the 24V AUX output state during reset and when the control panel is running on battery power. The default setting for both options is NO (the 24V AUX output is not deactivated).

#### To change the configuration:

1. Select Panel setup from the Main menu.
2. Select Other settings, and then select 24V AUX config.
3. Select YES or NO for deactivation during reset.
4. Select YES or NO for deactivation when running on battery power.
5. Press F4 (Enter), and then press F1 (Back).
6. Press F1 (Save), F3 (Apply), F4 (Discard), or F2 (Exit).

Remember to apply saved settings from the Main menu.

### Fault mask

Select the Fault mask option to configure the reporting status for battery and earth faults. The default setting for both options is YES (all faults are reported).

#### To change the configuration:

1. Select Panel setup from the Main menu.
2. Select Other settings, and then select Fault mask.
3. Select YES or NO for battery fault notifications.
4. Select YES or NO for earth fault notifications.
5. Press F4 (Enter), and then press F1 (Back).
6. Press F1 (Save), F3 (Apply), F4 (Discard), or F2 (Exit).

Remember to apply saved settings from the Main menu.

**Note:** If NO is selected for either option, the corresponding faults are not recorded in the event log.

## Sounders re-sound

Select the Sounder re-sound option to configure stopped sounder functionality when new zone alarms are reported. The available configuration options are shown below. The default setting is YES (sounders re-sound for new zone alarms).

**Note:** By default, sounders only re-sound for a new alarm (in the same zone) if a manual call point alarm is reported following a detector alarm.

**Table 26: Sounder re-sound configuration options**

YES (default)	A new zone in alarm re-sounds the sounders
NO	A new zone in alarm does not re-sound the sounders
Device	If checked, any new device in alarm in the same zone (including detectors) re-sounds the sounders.

### To change the configuration:

1. Select Panel setup from the Main menu.
2. Select Other settings, and then select Sounder re-sound.
3. Select YES or NO.
4. Select and check the Device check box if you want any new device in alarm in the same zone to re-sound the sounders.
5. Press F4 (Enter), and then press F1 (Back).
6. Press F1 (Save), F3 (Apply), F4 (Discard), or F2 (Exit).

Remember to apply saved settings from the Main menu.

### Device LEDs

Select the Device LEDs configuration option to disable addressable device LEDs flashing during communication with the control panel in devices that support this feature. By default device LEDs flash.

### To change the configuration:

1. Select Panel setup from the Main menu.
2. Select Other settings, and then select Device LEDs.
3. Select YES or NO.
4. Press F4 (Enter), and then press F1 (Back).
5. Press F1 (Save), F3 (Apply), F4 (Discard), or F2 (Exit).

Remember to apply saved settings from the Main menu.

## School bells

Select the School bells option to configure school bell operation and duration (in seconds). By default school bells are not activated.

### To change the configuration:

1. Select Panel setup from the Main menu.
2. Select Other settings, and then select School bells.
3. Select Activate school bells while input is ON, and then select YES or NO.  
Select YES for the school bells to sound only while the input is active, or NO if the bells should continue to sound when the input is off.
4. Select Time, and then enter the duration in seconds (1 to 10).  
Enter the school bell duration in seconds if you selected NO in step 3, or leave the duration blank if you selected YES.
5. Press F4 (Enter), and then press F1 (Back).
6. Press F1 (Save), F3 (Apply), F4 (Discard), or F2 (Exit).  
Remember to apply saved settings from the Main menu.

## Self-test

Select the Self-test option to schedule a functional self-test for each loop device and to generate a daily report in devices that support this feature. By default self-test is not enabled.

### To change the configuration:

1. Select Panel setup from the Main menu.
2. Select Other settings, and then select Self-test.
3. Select and check the Enabled check box.
4. Select and check the BeepTst check box.  
With this option checked, compatible sounders will emit a brief test tone during the self-test.
5. Select TestH, and then enter the start time for the self-test (00:00 to 23:59).
6. Select ReportH, and then enter the time for the report to be generated (00:00 to 23:59).
7. Press F4 (Enter), and then press F1 (Back).
8. Press F1 (Save), F3 (Apply), F4 (Discard), or F2 (Exit).  
Remember to apply saved settings from the Main menu.

## **Pulse activation**

Select the Pulse activation option to configure the fire routing output activation pulse time, in milliseconds, for external devices that require pulsed activation. By default the output activation is continuous.

This option is not available for repeaters or control panels that do not include fire routing controls.

### **To change the configuration:**

1. Select Panel setup from the Main menu.
2. Select Other settings, and then select Pulse Activation.
3. Select and clear the Contin. check box.
4. Select PulseT, and then enter the pulse time value in milliseconds (0 to 10000).

If the PulseT value is 0, the output activation is continuous.

5. Press F4 (Enter), and then press F1 (Back).
6. Press F1 (Save), F3 (Apply), F4 (Discard), or F2 (Exit).

Remember to apply saved settings from the Main menu.

## **Service mode timeout**

Select the Service mode timeout option to configure a timeout value (in minutes) for Service mode (see “Service mode” on page 49). By default the Service mode timeout is not enabled.

### **To change the configuration:**

1. Select Panel setup from the Main menu.
2. Select Other settings, and then select Service mode timeout.
3. Select and check the Enabled check box.
4. Select Timeout, and then enter the timeout value in minutes (1 to 120).

The default timeout value is 30 minutes.

5. Press F4 (Enter), and then press F1 (Back).
6. Press F1 (Save), F3 (Apply), F4 (Discard), or F2 (Exit).

Remember to apply saved settings from the Main menu.

## **Load/Save configuration**

### **Restoring the previous configuration**

Select the Restore configuration option to restore the previous system configuration.

**To restore the system configuration:**

1. Select Panel setup from the Main menu, and then select Configuration.
2. Select Restore configuration and confirm your selection.
3. Press F4 (Enter), and then press F1 (Back).
4. Press F1 (Save), F3 (Apply), F4 (Discard), or F2 (Exit).

Remember to apply saved settings from the Main menu.

**Loading and saving configuration files**

Select the Load configuration option or the Save configuration option to load a system configuration file from a USB flash drive or to save the current system configuration file to a USB flash drive.

**Note:** If your flash drive is not recognized by the control panel, reformat it as FAT32 from a PC and try again. If the problem persists, try a different flash drive.

**To load a configuration:**

1. Open the control panel door and insert the USB flash drive with the configuration file into either of the USB type A connectors (see Figure 4 on page 17). Close the control panel door.
2. Select Panel setup from the Main menu.
3. Select Configuration, and then select Load configuration.
4. Select the configuration file to load.
5. Press F4 (Enter), and then press F1 (Back).
6. Press F1 (Save), F3 (Apply), F4 (Discard), or F2 (Exit).

Remember to apply saved settings from the Main menu.

7. Remove the USB flash drive as described in “Removing a USB device” on page 45.

**To save a configuration to file:**

1. Open the control panel door and insert the USB flash drive into either of the USB type A connectors (see Figure 4 on page 17). Close the control panel door.
2. Select Panel setup from the Main menu.
3. Select Configuration, and then select Save configuration.

The current configuration is saved in XML format using a default naming format.

4. Press F4 (Enter), and then press F1 (Back).
5. Press F1 (Save), F3 (Apply), F4 (Discard), or F2 (Exit).

Remember to apply saved settings from the Main menu.

- Remove the USB flash drive as described in “Removing a USB device” on page 45.

### Restoring the default configuration

Select the Default configuraton option to restore the system to the default factory settings detailed in Appendix A “Default configurations” on page 117.

#### To restore the default system configuration:

- Select Panel setup from the Main menu, and then select Configuration.
- Select Default configuration and confirm your selection.
- Press F4 (Enter), and then press F1 (Back).
- Press F1 (Save), F3 (Apply), F4 (Discard), or F2 (Exit).

Remember to apply saved settings from the Main menu.

### Expansion board configuration

Select the Expansion boards option to add an installed expansion board to the control panel configuration.

The available expansion boards are shown in the table below.

**Table 27: Available expansion boards**

Option	Description
LB	Loop board
NB	Network board [1]
ZIC	Zone LED indicator board
PIB	Peripherals interface board
DACT	DACT board

[1] By default repeater panels have the network board configured as installed.

#### To add an expansion board:

- Select Panel setup from the Main menu.
- Select Expansion boards.
- Select the expansion board that you want to add, and then select YES.
- Press F4 (Enter), and then press F1 (Back).
- Press F1 (Save), F3 (Apply), F4 (Discard), or F2 (Exit).

Remember to apply saved settings from the Main menu.

If an installed expansion board is not detected by the control panel, a system fault is indicated.



## Load auxiliary files

Select the Load auxiliary files option to load auxiliary files from a USB flash drive. Auxiliary files that can be loaded include custom standby and alarm screens, and updated language or font files provided by the manufacturer.

### Loading custom standby and alarm screens

Select the Splash screens option to load custom standby and alarm screens in bitmap (BMP) format.

#### To load custom screen images:

1. Open the control panel door and insert the USB flash drive into either of the USB type A connectors (see Figure 4 on page 17). Close the control panel door.
2. Select Panel setup from the Main menu.
3. Select Configuration, and then select Load auxiliary files.
4. Select Splash screens.
5. Select the bitmap file to load and confirm the selection.
6. Press F4 (Enter), and then press F1 (Back).
7. Press F1 (Save), F3 (Apply), F4 (Discard), or F2 (Exit).  
Remember to apply saved settings from the Main menu.
8. Remove the USB flash drive as described in “Removing a USB device” on page 45.

### Loading language files or fonts

Select the Languages or Language fonts option to load language files or fonts provided by the manufacturer.

#### To load language files or fonts:

1. Open the control panel door and insert the USB flash drive with the required files into either of the USB type A connectors (see Figure 4 on page 17). Close the control panel door.
2. Select Panel setup from the Main menu.
3. Select Configuration, and then select Load auxiliary files.
4. Select Languages or Language fonts.
5. Select the file to load and confirm the selection.
6. Press F4 (Enter), and then press F1 (Back).

7. Press F1 (Save), F3 (Apply), F4 (Discard), or F2 (Exit).

Remember to apply saved settings from the Main menu.

8. Remove the USB flash drive as described in “Removing a USB device” on page 45.

## Firmware updates

**Caution:** Updating the control panel firmware may delete the current installation configuration data. Always back up your configuration data before updating the control panel firmware.

Select this option to load control panel firmware updates provided by the manufacturer. The update application may only be available in English.

### To update the firmware:

1. Select Panel setup from the Main menu, and then select Firmware update.
2. When prompted, open the control panel door and install a jumper onto JP4 on the control panel PCB (see Figure 23 below), and then press F3 (Reboot).

The control panel reboots. Follow the on-screen instructions.

3. When prompted, insert the USB flash drive with the firmware update into either of the USB type A connectors, and then press F3 (Continue).
4. When prompted, remove the USB flash drive as described in “Removing a USB device” on page 45.

Figure 23: USB and JP4 connectors on the control panel PCB

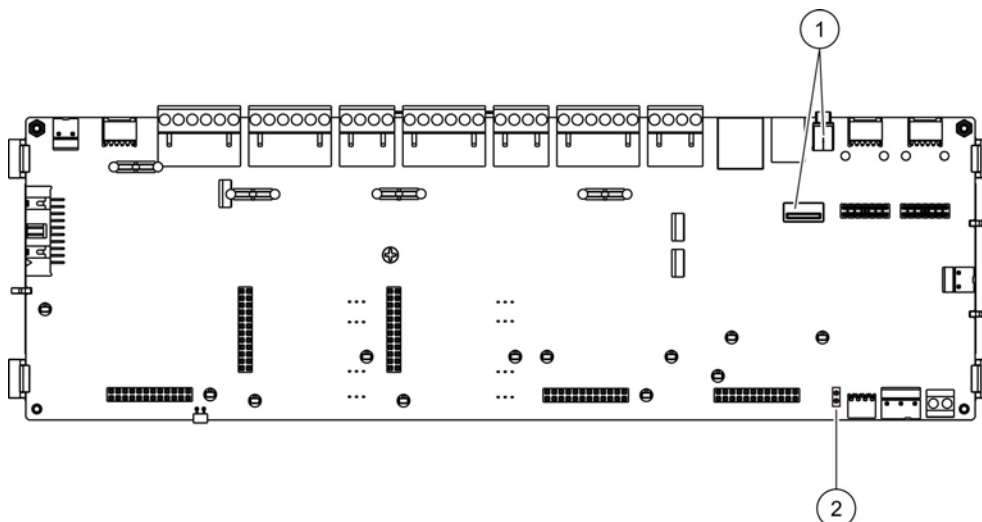

1. USB connectors
2. JP4

## Printer configuration

Select the Printer configuration option to configure external or internal printers, where available. Configuration options are shown in the table below. By default, all printer configuration options are disabled.

**Table 28: Printer configuration options**

Option	Description
Used	Configures the printer status (used or not used)
RportMd [1]	Configures the external printer for report printing
NWEvent [2]	Configures the printing of system events for all control panels in the network
Alarm [2]	Configures the printing of alarm events
Fault [2]	Configures the printing of fault events
Cond [2]	Configures the printing of condition events
StatCH [2]	Configures the printing of status change events (for example, inputs and outputs)

[1] This option is not available for internal printers.

[2] When RportMd is checked, these system events are not printed.

### To change the configuration:

1. Select Panel setup from the Main menu.
2. Select Other settings, and then select Printer config.
3. Select Int printer config or Ext printer config.
4. Select and check the check box for the options that you want to enable.
5. Press F4 (Enter), and then press F1 (Back).
6. Press F1 (Save), F3 (Apply), F4 (Discard), or F2 (Exit).

Remember to apply saved settings from the Main menu.

## DACT configuration

Select the DACT configuration option to configure settings for an installed DACT expansion board. Configuration options are shown in the table below.

**Table 29: DACT configuration options**

Option	Description
General config	Configures the DACT status (used or not used) and event reporting options
Ethernet config	Configures Ethernet settings for monitoring network communication with the central monitoring station (CMS)
CMS config	Configures CMS settings

Option	Description
PSTN config	Configures PSTN settings
GPRS config [1]	Configures GPRS settings

[1] Requires an optional GPRS expansion board to be installed.

## General configuration

Select the General configuration option to configure the DACT status (used or not used) and event reporting settings. Configuration options are shown in the table below.

**Table 30: General DACT configuration options**

Option	Description	Default value
Used	Configures the DACT status (used or not used)	Not used
FR_ERM [1]	Configures the event reporting mode for all configured central monitoring stations: Fire Routing mode (for alarm event transmission) if checked or Event Reporting mode if not checked	Event Reporting mode

[1] If checked, alarm events are transmitted when the fire routing group is activated and after any configured activation delay. If the transmission fails, a fire routing acknowledgement fault is indicated.

### To change the configuration:

1. Select Panel setup from the Main menu.
2. Select Other settings, and then select DACT config.
3. Select General config.
4. Select and check the check box for the options that you want to enable.
5. Press F4 (Enter), and then press F1 (Back).
6. Press F1 (Save), F3 (Apply), F4 (Discard), or F2 (Exit).

Remember to apply saved settings from the Main menu.

## Ethernet configuration

Select the Ethernet configuration option to configure settings for monitoring network communication with the central monitoring station (CMS). Configuration options are shown in the table below.

**Table 31: Ethernet configuration options**

Option	Description	Default value
Period	Configures the heartbeat period (in seconds)	3
Fails	Configures the minimum number of consecutive heartbeat failures required to indicate a communication error with the central monitoring station	3

### To change the configuration:

1. Select Panel setup from the Main menu.
2. Select Other settings, and then select DACT config.
3. Select Ethernet config.
4. Select Period, and then enter the value in seconds (1 to 99).
5. Select Fails, and then enter the value (1 to 10).
6. Press F4 (Enter), and then press F1 (Back).
7. Press F1 (Save), F3 (Apply), F4 (Discard), or F2 (Exit).

Remember to apply saved settings from the Main menu.

## CMS configuration

Select the CMS configuration option to configure central monitoring station settings. Up to six monitoring stations can be added. Configuration options are shown in the table below.

**Table 32: CMS configuration options**

Option	Description	Default value
IP/Port	Configures the CMS IP address and communication port.	000.000.000.000/ 09999
Alarm	Configures the CMS priorities for reporting alarm events: NO (no reporting), P (primary CMS), B1 (first backup CMS), B2 (second backup CMS), etc. [1]	NO
Fault	Configures the CMS priorities for reporting fault events: NO (no reporting), P (primary CMS), B1 (first backup CMS), B2 (second backup CMS), etc. [1]	NO
Cond	Configures the CMS priorities for reporting condition events: NO (no reporting), P (primary CMS), B1 (first backup CMS), B2 (second backup CMS), etc. [1]	NO
Enabled	Enables or disables communication with the CMS.	NO

Account	Configures the account information that identifies the control panel. Maximum 6 digits (hexadecimal). Possible values: 0 to 9 and A to F.	000000
Receiv.	Configures the four-digit TCP/IP receiver number for the CMS.	0000
Line	Configures the four-digit TCP/IP line number for the CMS.	0000
Network	Configures the network type (Ethernet or GPRS).	ETH
FR_ERM [2]	Configures the event reporting mode for the corresponding central monitoring station: Fire Routing mode (for alarm event transmission) if checked or Event Reporting mode if not checked.	Event Reporting mode

[1] In the event of communication problems reporting an event to the primary CMS, the control panel attempts to send the event notification to the configured backups in order of the assigned priority.

[2] The global FR\_ERM setting in General Configuration takes priority over any individual CMS setting configured here.

### To change the configuration:

1. Select Panel setup from the Main menu.
2. Select Other settings, and then select DACT config.
3. Select CMS config, and then Select the CMS to configure (1 to 6).
4. Configure all required settings.
5. Press F4 (Enter), and then press F1 (Back).
6. Press F1 (Save), F3 (Apply), F4 (Discard), or F2 (Exit).

Remember to apply saved settings from the Main menu.

### PSTN configuration

Select the PSTN configuration option to configure public switched telephone network settings. Configuration options are shown in the table below.

**Table 33: PSTN configuration options**

Option	Description	Default value
Ccode	Configures the PSTN country code [1]	099
Line 1	Enables or disables line 1 [2]	Disabled
Line 2	Enables or disables line 2 [2]	Disabled
Retries	Configures the maximum number of times the number is dialled	05
Kissoff	Configures the kiss-off acknowledgement time	48 x 10 ms

[1] See Appendix B “PSTN country codes” on page 119 for a complete list of country codes.

[2] These correspond to the line 1 and line 2 connectors on the installed DACT board.

**To change the configuration:**

1. Select Panel setup from the Main menu.
2. Select Other settings, and then select DACT config.
3. Select PSTN config.
4. Configure all required settings.
5. Press F4 (Enter), and then press F1 (Back).
6. Press F1 (Save), F3 (Apply), F4 (Discard), or F2 (Exit).

Remember to apply saved settings from the Main menu.

**GPRS configuration**

Select the GPRS configuration option to configure general packet radio service (GPRS) settings. Configuration options are shown in the table below.

**Note:** GPRS functionality requires an optional GPRS expansion board to be installed.

**Table 34: GPRS configuration options**

Option	Description	Default value
PIN	Configures the sim card PIN number	0000
APN	Configures the network Access Point Name (APN)	
User	Configures the network user name	
Description	Configures the description	
Password	Configures the network password	
Period	Configures the heartbeat period (in seconds)	60 s
Fails	Configures the minimum number of consecutive heartbeat failures required to indicate a communication error with the central monitoring station	03

**To change the configuration:**

1. Select Panel setup from the Main menu.
2. Select Other settings, and then select DACT config.
3. Select GPRS config.
4. Configure all required settings.
5. Press F4 (Enter), and then press F1 (Back).
6. Press F1 (Save), F3 (Apply), F4 (Discard), or F2 (Exit).

Remember to apply saved settings from the Main menu.

## Field configuration

Use the Field setup menu to access the field configuration options shown below.

**Table 35: Field configuration options**

Option	Description
Autosetup	Automatically configures installed loop devices to their default settings.
Loop device configuration	Configures installed loop devices or change default settings.
Zone configuration	Configures zones.
Panel I/O configuration	Configures control panel input and output functionality.
Output groups	Configures output groups.
Activation configuration	Configures output group delays and regional investigation time options.
Loop class	Configures the installation loop wiring Class (Class A or Class B).

### Autosetup

Select the Autosetup option to automatically configure installed loop devices. Autosetup assigns a default configuration for each device type detected.

#### To begin autosetup:

1. Select Field setup from the Main menu, and then select Autosetup.
2. Select the corresponding loop or All loops.

During the search the LCD displays the message “Autosetup in progress”. When the autosetup is complete the list of detected devices is displayed.

3. Press F4 (Enter), and then press F1 (Back).
4. Press F1 (Save), F3 (Apply), F4 (Discard), or F2 (Exit).

Remember to apply saved settings from the Main menu.

#### Autosetup will:

- Assign all initiating devices (including zone modules) to zone 1
- Assign all sounder devices to the default sounder output group (output group number 1)
- Assign all nonsupervised outputs (relays) to the default program output group (output group number 301)
- Assign all extinguishing devices to the default extinguishing output group (output group number 801)

Extinguishing output groups are only activated with a confirmed alarm. They are not activated by zone alarms and rules.



- Assign all fire routing outputs (where available) to the default fire routing output group (output group number 971)
- Assign all fire protection outputs (where available) to the default fire protection output group (output group number 981)
- Assign the default initial zone to zone 1

By default all zones activate all output groups with no delay.

**Note:** Autoseup is incremental and retains the device text description for previously configured devices.

## Loop device configuration

Select the Loop device configuration option to manually add devices or to change the default configuration settings after autoseup.

### To add a device or to change a device configuration:

1. Select Field setup from the Main menu, and then select Loop device configuration.
2. Select the corresponding loop and device.  
For new devices, a message is displayed.
3. Make the required configuration changes (device type, operating mode, text, etc.).
4. Press F4 (Enter), and then press F1 (Back).
5. Press F1 (Save), F3 (Apply), F4 (Discard), or F2 (Exit).

Remember to apply saved settings from the Main menu.

## Zone configuration

Zone configuration options are shown in the table below.

**Table 36: Zone configuration options**

Option	Description
General config	Configures the initial zone, the initial zone for a zone LED indicator (if an optional zone indicator board is installed), and the test or disable timeout period.
Zone config	Configures additional zone settings, such as the zone type (normal or confirmed with corresponding parameters), area, CIT and ACT delays, disabled or enabled, operation mode, etc.
Area config	Configures areas. An area is a group of zones used for alarm confirmation.

## Zone overview

The maximum number of zones available depends on the control panel model, as shown in the table below. The zone number range is 01 to 9999.

**Note:** For 2010-2GUI application compatibility, assigned zone numbers must be in the range 1 to 4095 (zones with higher numbers will be discarded).

**Table 37: Maximum number of zones**

One-loop control panel	64 zones max.
Two-loop control panel	128 zones max.
Two-loop control panel with loop board	256 zones max.

Zones in networked control panels are considered global. If two networked control panels each include, for example, Zone 5, then these are grouped to create a single Zone 5 configuration within the network.

## Remote zones

The control panel also considers an additional zone called remote zone (REMT) which spans all the zones in the system outside the control panel zones range. This virtual zone can be configured like any other zone in the system and it is important to define output group activation requirements when the panel receives remote alarms.

## Assigning loop devices to zones

Create zones by assigning zone numbers to loop devices.

### To assign a zone number to a loop device:

1. Select Field setup from the Main menu.
2. Select Loop device configuration.
3. Select the corresponding loop and device.
4. Assign a zone number to the device.
5. Press F4 (Enter), and then press F1 (Back).
6. Press F1 (Save), F3 (Apply), F4 (Discard), or F2 (Exit).

Remember to apply saved settings from the Main menu.

Repeat as required for each device.

If the zone number is outside the valid range determined by the corresponding initial zone and the number of loops of the control panel, the operation does not complete and an invalid zone number error is displayed on the LCD.

## General configuration

Select the General configuration option to configure the initial zone, to configure the initial zone for a zone LED indicator (if an optional zone indicator board is installed), or to set a zone test or disable timeout period. Default settings are shown in the table below.

**Table 38: General zone configuration options**

Option	Description	Default value
Set initial zone number	Configures the initial zone for the fire system. See “Initial zone” below for more information.	1
Assign first ZI LED to zone	Configures the initial zone LED for an installed zone LED indicator board. See “First zone indicator LED” on page 78 for more information.	1
Test/disable timeout	Configures a timeout value (in minutes) for zone test and disablement operations for the local control panel. See “Zone test/disable timeout” on page 78 for more information. [1]	060/000 [2]

[1] This feature is not compliant with EN 54-2.

[2] Default 060/000 corresponds to 60 minutes test timeout and no disable timeout.

### To change the configuration:

1. Select Field setup from the Main menu, and then Zone configuration.
2. Select General config.
3. Make the required configuration changes.
4. Press F4 (Enter), and then press F1 (Back).
5. Press F1 (Save), F3 (Apply), F4 (Discard), or F2 (Exit).

Remember to apply saved settings from the Main menu.

### Initial zone

The initial zone defines the starting point of the fire alarm control panel zone range. The remaining zones for the corresponding control panel follow sequentially, as shown in the table below.

**Table 39: Initial zones**

Control panel	Initial zone	Remaining zones
One-loop control panel	1	2 to 64
One-loop control panel	200	201 to 263
Two-loop control panel	1	2 to 128
Two-loop control panel	520	521 to 647

For repeater panels without a zone board, the initial zone value is not used as the panel has no zones. The repeater panel displays zone events of the panels being repeated.

### First zone indicator LED

The first zone indicator LED defines the zone number for the first LED (top left) for an installed zone indicator board. The remaining zones for the corresponding control panel follow sequentially, as shown in Table 40 below.

The initial zone range is as follows:

- Between 01 and 9960 for a 40-zone indicator board
- Between 01 and 9980 for a 20-zone indicator board
- Between 01 and 9976 for a 24-zone indicator board

**Table 40: Zone LED indicator initial zones**

Zone indicator board	Initial zone	Remaining zones
20-zone indicator board [1]	1	2 to 20
40-zone indicator board [1]	200	201 to 239
24-zone indicator board [2]	9976	9977 to 9999

[1] For large cabinet control panels.

[2] For small cabinet control panels.

**Note:** Ensure that the zone numbers selected are inside the zone range of the control panel in networked mode or that the zone numbers are inside the range of the zones repeated by the control panel.

### Zone test/disable timeout

The Zone test/disable timeout sets an independent timeout value (in minutes) for zone test and disablement operations for the local control panel.

When the control panel is in a Maintenance or Installer user level, active zone test or disablement operations stop when the corresponding timeout value is reached.

The default test timeout value is 60 minutes. This value must be set to 000 to disable the timeout and to force the manual cessation of zone test operations. By default, no disable timeout value is configured.

Zones previously disabled via the Zone configuration menu are not included in the timeout command and no changes are made to zone status.

**Note:** This feature is not compliant with EN 54-2.

## Zone configuration

Select the Zone configuration option to configure additional zone settings, such as the zone type (normal or confirmed with corresponding parameters), area, CIT and ACT delays, disabled or enabled, and operation mode. Default settings are shown in the table below.

**Table 41: Zone configuration options**

Option	Description	Default value
Type	Configures the zone alarm confirmation type. See “Zone alarm confirmation” on page 80 for more information.	NML (normal, no confirmation required)
Area [1] [2]	Configures the area number for zone types requiring confirmation by an area. See “Area configuration” on page 82 for more information.	1
CIT/ACT [1]	Configures CIT and ACT delays for zones that require confirmation. See “Confirmation Inhibition Time (CIT) and Alert Cancellation Time (ACT)” on page 81 for more information.	CIT: 60 seconds ACT: 5 minutes
Control	Enables or disables the zone (with options for day/night mode disablement).	ENB (enabled)
[BLANK]	Zone description.	
OpMode	Configures the zone operating mode (Mixed, Manual, Auto, MSP, or MHA). See “Zone operating modes” on page 81 for more information.	Mixed
DbKnokZ [3]	Configures MCP double detection for the zone. If checked, when two automatic devices indicate an alarm in the zone, the second alarm is processed as a manual call point alarm.	Disabled

[1] Not required for zone type NML (normal, no confirmation required).

[2] Not required for zones that confirm an alarm in the same zone.

[3] Only available for zone type NML.

### To change the zone configuration settings:

1. Select Field setup from the Main menu, and then Zone configuration.
2. Select Zone configuration, and then select the corresponding zone from the list of zones displayed.
3. Make the required configuration changes.
4. Press F4 (Enter), and then press F1 (Back).
5. Press F1 (Save), F3 (Apply), F4 (Discard), or F2 (Exit).

Remember to apply saved settings from the Main menu.

**Note:** If all the devices assigned to a zone are disabled, then the zone is considered to be disabled and is indicated accordingly on the control panel.

### Zone alarm confirmation

Zone confirmation is an alarm coincidence configuration method designed to reduce nuisance alarms. A first alarm event places the zone and the control panel into alert status. Full alarm status is not confirmed until a second alarm is reported in the same zone or in a configured area. See “Area configuration” on page 82 for more information on areas.

Zone alarm confirmation types and descriptions are shown below.

**Table 42: Zone alarm confirmation types**

Option	Description
NML (default)	No confirmation is required.
sD(A) (type A EN 54-2)	The alarm is confirmed by the same detector. Alarms generated by a manual call point are not confirmed and activate a control panel alarm immediately.
aDsZ (type A EN 54-2)	The alarm is confirmed by the same detector or by a different detector in the same local zone. Alarms generated by a manual call point are not confirmed and activate a control panel alarm immediately.
dDsZ (type A EN 54-2)	The alarm is confirmed by a different detector in the same local zone. Alarms generated by a manual call point are not confirmed and activate a control panel alarm immediately.
aDMsZ	The alarm is confirmed by a single manual call point and a single detector in the same local zone irrespective of which device first reports the alarm event.
aIMsZ	The alarm is confirmed by a single manual call point and a single initiating device in the same local zone irrespective of which device first reports the alarm event.
dMsZ	The alarm is confirmed by two different manual call points in the same local zone irrespective of which device first reports the alarm event. A detector alarm places the zone in alert status.
sD(B)	The alarm is confirmed by the same detector but with longer inhibition time than the sD(A) confirmation option. Alarms generated by a manual call point are not confirmed and activate a control panel alarm immediately.
aDaZ (type B EN 54-2)	The alarm is confirmed by the same detector or by a different detector in the same local area. Alarms generated by a manual call point are not confirmed and activate a control panel alarm immediately.
dDaZ (type B EN 54-2)	The alarm is confirmed by a different detector in the same local area. Alarms generated by a manual call point are not confirmed and activate a control panel alarm immediately.
aDMaZ	The alarm is confirmed by a single manual call point and a single detector in the same local area irrespective of which device first reports the alarm event.

Option	Description
aIMaZ	The alarm is confirmed by a single manual call point and a single initiating device in the same local area irrespective of which device first reports the alarm event.
dMaZ	The alarm is confirmed by two different manual call points in the same local area irrespective of which device first reports the alarm event. A detector alarm places the zone in alert status.

### Confirmation Inhibition Time (CIT) and Alert Cancellation Time (ACT)

All zones configured for alarm confirmation must include configured delay periods for Confirmation Inhibition Time (CIT) and for Alert Cancellation Time (ACT). Maximum delay values for each are shown in the table below.

**Table 43: CIT and ACT**

Timer	Description	Maximum values
CIT	A configurable period during which the reporting of a second alarm event does not confirm an alarm	60 seconds [1] 240 seconds [2][3]
ACT	A configurable period after which the control panel exits alert status and returns to standby status	30 minutes [1] 30 minutes [2]

[1] EN 54-2 type A confirmation.

[2] EN 54-2 type B confirmation.

[3] Only inhibits the alarm confirmation from the first initiating device for confirmation types aDaZ, dDaZ, aDMaZ, aIMaZ, and dMaZ.

### Zone operating modes

All zones must be configured as Mixed, Manual, Auto, MSP, or MHA. Information for each of these zone operating modes is shown in the table below. By default all zones are mixed.

**Table 44: Zone operating modes**

Operating mode	Description
Mixed	The zone may contain a mix of automatic and manual alarm devices.
Manual [1]	The zone only allows manual call points (or inputs configured for MCP operation mode).
Auto [1]	The zone only allows detectors (or inputs configured for detector operation mode).
MSP [1]	The zone only allows sprinkler manual call points (or inputs configured for sprinkler manual call point operation mode).  Fire routing, fire protection, and sounder output groups are activated in the event of an alarm in a zone operating in this mode.

Operating mode	Description
MHA [1]	<p>The zone only allows “hausalarm” manual call points (or inputs configured for “hausalarm” manual call point operation mode).</p> <p>Fire routing output groups are not activated in the event of an alarm in a zone operating in this mode.</p>

[1] The control panel will not allow configuration of zone devices or inputs that do not meet the corresponding criteria shown in the Description column.

## Area configuration

Select the Area configuration option to configure confirmation areas. An area is a group of zones where an alarm event can confirm the initial alarm in a zone.

The maximum number of areas available to configure is the same as the number of zones for the control panel:

- A one-loop control panel has 64 zones and 64 areas
- A two-loop control panel has 128 zones and 128 areas
- A four-loop control panel has 256 zones and 256 areas

### To configure an area:

1. Select Field setup from the Main menu, and then select Zone configuration.
2. Select Area configuration.
3. Select the area number to configure.

A list of available zones is displayed.

4. Select zones to be included in the confirmation area and press the jog dial to confirm each selection.

YES indicates that a zone is included in the confirmation area, NO indicates that a zone is not included in the confirmation area.

5. Press F1 (Save), F3 (Apply), F4 (Discard), or F2 (Exit).

Remember to apply saved settings from the Main menu.

**Note:** When configuring a confirmed zone, remember that remote zones with the same zone number can activate a control panel alarm without confirmation. To avoid this type of unwanted alarm, configure the remote zones accordingly.



## Panel I/O configuration

### Panel input configuration

Configurable options for control panel inputs are shown below.

**Table 45: Configurable options for control panel inputs**

Option	Description
Type	Configures the input operation mode
Control	Enables or disables an input

Input types are shown in Table 46 below. The default mode for all inputs is LG (logged activation: an unlatched condition stored in the event log).

#### To configure a control panel input:

1. Select Field setup from the Main menu.
2. Select Panel I/O configuration.
3. Select Panel inputs, and then select the corresponding panel input.
4. Select the input type.

See Table 46 below for a list of available input types.

5. Press F4 (Enter), and then press F1 (Back).
6. Press F1 (Save), F3 (Apply), F4 (Discard), or F2 (Exit).

Remember to apply saved settings from the Main menu.

**Table 46: Configurable input types**

Type	Description
LG (default)	Logged activation. An unlatched condition that generates no indications but it is only stored on the event log.
T_AL	Technical alarm activation. A latched condition indicated on the LCD and stored in the event log.  This input type can be used for gas detectors.
T_ALu	Technical alarm activation. An unlatched condition indicated on the LCD and stored in the event log.  This input type can be used for gas detectors and for connecting to aspirating detector Alert outputs.
DT_AL	Disable technical alarm inputs. When active, this input disables all the technical alarm inputs (latched and unlatched).
DET	Detector alarm.  This input type can be used for connecting to aspirating detector Fire1 outputs.

<b>Type</b>	<b>Description</b>
MCP	Manual call point alarm. This input type can be used for connecting to aspirating detector Fire2 outputs.
PREAL	Prealarm (unlatched). This input type can be used for connecting to aspirating detector Action outputs.
RST	Activation resets the panel remotely. To reset again, the input must be deactivated, and then activated again.
FLT	External fault. Activation generates a latched fault event indicated as an external fault.
DAY	Day mode. When this input is activated, the control panel switches to day mode until the next scheduled night mode change (or until the output is deactivated).
NIGHT	Night mode. When this input is activated, the control panel switches to night mode until the next scheduled day mode change (or until the output is deactivated).
FOS	Fault Warning Output Open Supervision. By using a 2010-FS-EOL end-of-line device, the control panel can supervise the open circuit condition of the Fault Warning output.
FRAK1	Fire routing acknowledgement (type 1). The input receives acknowledgement from the remote monitoring equipment that the fire routing signal was received correctly. If the acknowledgement is not received within 100 seconds of fire routing activation, the control panel reports a fire routing fault.
FRAK2	Fire routing acknowledgement (type 2). The input receives acknowledgement from the remote monitoring equipment that the fire routing signal was received correctly. If the acknowledgement is not received within 240 seconds of fire routing activation, the control panel reports a fire routing fault.
FPAK1	Fire protection acknowledgement (type 1). The input receives acknowledgement from remote fire protection equipment. If the acknowledgement is not received within 100 seconds of fire protection activation, the control panel reports a fire protection fault.
FPAK2	Fire protection acknowledgement (type 2). The input receives acknowledgement from remote fire protection equipment. If the acknowledgement is not received within 240 seconds of fire protection activation, the control panel reports a fire protection fault.
FP_FT	Fire protection fault. Used to indicate remote faults in fire protection equipment.
FBFSD	FBF sounders disable. The input is configured to interface to remote FBF equipment to disable or enable sounders.
UKSB	British school class change. Activation activates sounders for school class change indication.
MSP	Manual call point alarm (sprinkler).
MHA	Manual call point alarm (“hausalarm”).

**To enable or disable a control panel input:**

1. Select Field setup from the Main menu.
2. Select Panel I/O configuration.
3. Select Panel inputs, and then select the corresponding input.
4. In the Control option, select ENB (enable), DIS (disable), DIS\_D (disable in day mode), or DIS\_N (disable in night mode).
5. Press F4 (Enter), and then press F1 (Back).
6. Press F1 (Save), F3 (Apply), F4 (Discard), or F2 (Exit).

Remember to apply saved settings from the Main menu.

**Panel output configuration**

Configurable options for control panel outputs are shown below.

**Table 47: Configurable options for control panel outputs**

Option	Description
Type	Configures the output operation mode
Group_n	Configures the output group number
Class	Configures the output wiring configuration (Class A or Class B)
Control	Enables or disables an output
[BLANK]	Output description
UKSB	Configures the output group activation when the UK school bell activates

**To configure a control panel output:**

1. Select Field setup from the Main menu.
2. Select Panel I/O configuration.
3. Select Panel outputs, and then select the corresponding output.
4. Select the output type.

See Table 48 on page 86 for a list of available output types. The default setting for all outputs is SND (sounder output).

5. Assign the output to an output group.

See “Output groups” on page 86 for more information on output groups.

6. Select the output Class (Class A or Class B).

The default setting is Class B.

7. Press F4 (Enter), and then press F1 (Back).
8. Press F1 (Save), F3 (Apply), F4 (Discard), or F2 (Exit).

Remember to apply saved settings from the Main menu.

Configurable output types are shown in the table below.

**Table 48: Configurable output types**

Type	Description
SND (default)	Select this option for a sounder output
FR	Select this option for a fire routing output
FP	Select this option for a fire protection output
PRG	Select this option for program options (see below)
EXTIN	Select this option for an extinguishing output
ALARM	Select this option for an output that activates when the control panel is in alarm status
FAULT	Select this option for an output that activates when the control panel is in fault status
TEST	Select this option for an output that activates when the control panel is in test status
DIS	Select this option for an output that activates when the control panel is in disable status

#### To enable or disable a control panel output:

1. Select Field setup from the Main menu.
2. Select Panel I/O configuration.
3. Select Outputs, and then select the output to be enabled or disabled.

Configurable outputs are listed as OUT1, OUT2 etc, the supervised alarm output is listed as ALM\_O, and the supervised fault output is listed as FLT\_O.

4. In the Control option, select ENB (enable), DIS (disable), DIS\_D (disable in day mode), or DIS\_N (disable in night mode).
5. Press F4 (Enter), and then press F1 (Back).
6. Press F1 (Save), F3 (Apply), F4 (Discard), or F2 (Exit).

Remember to apply saved settings from the Main menu.

**Note:** At the installer level, changes to the configuration of a Class A output are applied to all output pairs used to create the Class A output (OUT1/OUT2, etc.). This includes enable/disable configuration options. For example, if the OUT1 type is changed to PRG and Group-n changed to 5, then the configuration of the paired OUT2 is updated automatically to match these settings.

#### Output groups

Select the Output groups option to configure the control panel output groups. Control panel outputs must be assigned to output groups for activation.

An output group is a collection of outputs of the same type that activate and deactivate at the same time (they are commanded simultaneously). Output groups are identified by the output group number.

Outputs are assigned to the default output groups during autoseup (see “Autoseup” on page 74).

Up to 300 sounder, fire routing, fire protection, extinguishing, and program output groups can be configured (depending on group type).

Sounder output groups, fire routing output groups, and fire protection output groups are controlled (and their status indicated) by the corresponding sounder, fire routing, and fire protection buttons and LEDs on the front of the control panel.

Program output groups have no associated buttons or LEDs on the front of the control panel but their status is displayed on the LCD.

The default control panel output groups are shown below.

**Note:** This option is not available on repeater panels.

**Table 49: Default output groups**

Group number	Type	Description
1	SND	Sounder and supervised outputs.
301	PRG	Nonsupervised relay outputs. These outputs are assigned to this group during autoseup.
801	EXTIN	Extinguishing device outputs. [1]
971	FR	Fire routing outputs. This group is only available on control panels with the corresponding fire routing controls.
981	FP	Fire protection outputs. This group is only available on control panels with the corresponding fire protection controls.
991	ALARM [2]	Outputs activated when the control panel is in alarm status.
992	FAULT [2]	Outputs activated when the control panel is in fault status.
993	DIS [2]	Outputs activated when the control panel is in disable status.
994	TEST [2]	Outputs activated when the control panel is in test status.

[1] Extinguishing output groups are only activated with EN 54 type C alarm confirmation.

[2] These output groups are not configurable.

Configurable options for output groups are shown below.

**Table 50: Configurable options for output groups**

Option	Description
Group_n	Configures the output group number
Type	Configures the output group type
Control	Enables or disables the output group
[BLANK]	Output description

### **To configure a default output group:**

1. Select Field setup from the Main menu, and then select Output groups.
2. Select Output groups.

A list of the available output groups is displayed. Press F3 (Search) to search by group number. Press F4 (Delete) to delete an output group.

3. Select the output group to configure.

You cannot change the group number or output group type for a default output group.

4. In the Control option, select ENB (enable), DIS (disable), DIS\_D (disable in day mode), or DIS\_N (disable in night mode).
5. Enter a brief text description for the output group.
6. Press F4 (Enter), and then press F1 (Back).
7. Press F1 (Save), F3 (Apply), F4 (Discard), or F2 (Exit).

Remember to apply saved settings from the Main menu.

### **To add a new output group:**

1. Select Field setup from the Main menu, and then select Output groups.
2. Select Output groups.

A list of the available output groups is displayed.

3. Press F3 (Search), and then enter a number for the new output group that you want to add.

Press the jog dial to confirm the entry.

4. Select the output group type (PRG, EXTIN, SND, FR, or FP).
5. In the Control option, select ENB (enable), DIS (disable), DIS\_D (disable in day mode), or DIS\_N (disable in night mode).
6. Enter a brief text description for the output group.
7. Press F4 (Enter), and then press F1 (Back).
8. Press F1 (Save), F3 (Apply), F4 (Discard), or F2 (Exit).

Remember to apply saved settings from the Main menu.

### **Output group activation**

Output groups can be activated by any of the following:

- Zone activation with delays
- Output group confirmation for specific outputs (EN 54-2 type C)
- Logic rules (configured via the Configuration Utility PC application)
- Manual activation by programmable start/stop buttons (evacuation panels only)

To avoid unexpected alarm behaviour, consider the activation options when configuring your fire system. If zone activation is not programmed correctly then a zone in alarm could override any required confirmation configuration of an output group.

### Delayed output group activation with alarm confirmation

**Note:** This option is compliant with EN 54 type C alarm confirmation.

Activation of control panel output groups can be delayed based on alarm confirmation configuration (this may be used, for example, with outputs for extinguishing devices). The maximum configurable delay is 999 seconds.

The output group alarm confirmation configuration options are shown in the table below.

**Note:** Configuration requires that two independent alarm confirmations be selected from the available options and that a confirmation delay (in seconds) is entered for the corresponding output group to be activated.

**Table 51: Output group alarm confirmation options**

Option	Description
DEV I.ddd	An alarm activated by a predefined loop and addressable device, where “I” is the loop number and “ddd” is the device address
ZONE zzzz	An alarm activated by a predefined global zone, where “zzzz” is the global zone number (from 1 to 9999)
PANEL pp	An alarm activated by a predefined control panel, where “pp” is the control panel network node ID (from 1 to 32)
ALWAYS	If only a single alarm event with confirmation delay is required (for example for a manual call point zone), select the corresponding first alarm event, and then select this option for the second alarm

### To configure delayed output group activation:

1. Select Field setup from the Main menu, and then select Output groups.
2. Select Confirmations, and then select the output group to configure.

A list of the available output groups that allow alarm confirmation configuration is displayed.

3. Select Active, and then select YES (alarm confirmation is required) or NO (alarm confirmation is not required).
4. Select Alarm1, and then select the confirmation required (DEV, ZONE, PANEL, or ALWAYS). Repeat this step for Alarm2.

If alarm confirmation is required then the output group is activated only when both configured alarm confirmation states are detected during the confirmation delay period.

Extinguishing output group confirmation requires two zones to be configured for Alarm1 and Alarm2. See note below.

5. Select Delay, and then enter the confirmation delay in seconds (0 to 999).
6. Select EXTnode, and then enter the address of the extinguishing control panel.

This field is only available when configuring confirmation for an extinguishing output group.

7. Press F4 (Enter), and then press F1 (Back).
8. Press F1 (Save), F3 (Apply), F4 (Discard), or F2 (Exit).

Remember to apply saved settings from the Main menu.

### Note

A remote extinguishing panel can be configured to receive extinguishing preactivate and activate commands associated with the local extinguishing output group confirmation.

When one of the two configured confirmation zones (Alarm1, Alarm2) enters into alarm, the preactivate command is sent to the extinguishing panel (EXTnode). When the second zone enters into alarm, the activate command is sent to the extinguishing panel.

### Assigning an output group to a programmable button

Up to seven output groups can be assigned to the programmable buttons and LEDs on the control panel interface for control and indication. This option is only available for evacuation panels. By default, all programmable buttons are set to sounder group 1.

Evacuation panels operating in NEN 2575 mode can only assign sounder output groups to the programmable buttons. Evacuation panels operating in other modes can assign any of the available output group types to the buttons.

Remember to create the output groups that you need before configuring the programmable buttons. See “Output groups” on page 86 for more information.

### To assign an output group to a programmable button:

1. Select Field setup from the Main menu, and then select Output groups.
2. Select Progr. Controls.
3. Select the button/LED to configure.

Programmable buttons are numbered #1 to #7, top to bottom.

4. Select and check In Use.
5. Select OpMode, and then select the output group mode.
6. Select Group\_n, and then enter the number of the output group that you want to assign to the button.
7. Select Delay, and then enter any required confirmation delay (in seconds).

The delay counts down after the Confirm button is pressed before activating the assigned output group. The maximum delay value is 600 seconds.



8. Press F4 (Enter), and then press F1 (Back).
9. Press F1 (Save), F3 (Apply), F4 (Discard), or F2 (Exit).

Remember to apply saved settings from the Main menu.

## Activation configuration

Select Activation configuration options to configure the activation delays for output groups, investigation times, and general sounders behaviour (sounder silencing and second stage usage).

**Note:** This option is not available on repeater panels.

Delay configuration options are shown in the table below.

**Table 52: Activation configuration options**

Option	Description
Sounders	Configures the activation of sounder groups with zones in alarm. A warning delay can also be configured if the second stage delay option is required.
Fire routing	Configures the activation of fire routing groups with zones in alarm.
Fire protection	Configures the activation of fire protection groups with zones in alarm.
Program	Configures the activation of program groups with zones in alarm.
Per zone	Configures the activation of output groups for each individual zone in alarm. For each zone, a different output group activation delay (including no activation) can be assigned for each configured output group.
General delays	Configures sounder silence disable time, maximum acknowledge time or extended fire routing delays, and warning time for second stage sounders applications.

### Sounder, fire routing, fire protection, and program output group delays

Select an output group type option to configure delays (including no activation) for sounder, fire routing, fire protection, and program output groups for all zones.

These output groups can be configured individually or all output group types at the same time. All zones are programmed with the same setting: global delay or no activation.

Configurable options for output group delays are shown in the table below.

**Table 53: Configurable options for output group delays**

Field	Description
Group_n	Output group selection (all output groups of the type selected or a single output group of the type selected)
Active	Output group activation (yes or no)

Field	Description
Delay	The delay (in minutes and seconds)
Wrn_Dly [1]	The warning delay (in minutes and seconds)

[1] Sounder output group delays only.

### To configure the output group delay:

1. Select Field setup from the Main menu, and then select Activation configuration.
2. Select the output group type to configure (Sounder, Fire routing, etc.).
3. Select Group\_n, and then select ALL (to configure common delay settings for all output groups of the type selected) or select the output group number (to configure custom delay settings for a single output group of the type selected).
4. Select Active, and then select YES (to confirm output group activation in case of an alarm) or NO (to deactivate the output group).
5. Select Delay and enter the required delay in minutes and seconds.

The maximum delay value for sounder, fire routing, and fire protection output groups is 10 minutes. The maximum delay value for program output groups is 16 minutes and 40 seconds.

6. If required, enter a warning delay (in minutes and seconds) for sounder output groups in applications using warning tones (second stage sounders).

A warning delay is only observed if the corresponding warning time is also configured (see “Warning time” on page 97 for more information on this option). The maximum warning delay value is 10 minutes.

7. Press F4 (Enter), and then press F1 (Back).
8. Press F1 (Save), F3 (Apply), F4 (Discard), or F2 (Exit).

Remember to apply saved settings from the Main menu.

Once a delay has been configured, it must be enabled.

Configured delays are only activated for alarms activated by a detector. Alarms activated by a manual call point ignore any configured delays.

Configured delays can be enabled or disabled by sensitivity mode programming (day/night mode), remote equipment by means of a programmed input, or the user interface delay buttons.

By default, the control panel does not process delays when operating in night mode. Remember that night mode can be activated by the day/night mode schedule, the holiday calendar, or by remote equipment. For specific applications, a delay in night mode can be configured if required. See “Additional day/night mode settings” on page 43.

Use these options to configure, for example, activation of sounders and fire routing with 2 minute delay for any zone in alarm in the fire network inside the fire alarm panel zone range.

### Notes

- Global delay options only set the delays of the zones that are enabled to activate the sounder or fire routing group. For example, if sounders and fire routing activate for zone 1 with a delay of 10 seconds and for zone 5 with a delay of 2 minutes, when selecting this option, sounders and fire routing will activate with the same selected delay after alarms in zones 1 or 5 and will not activate for all the other zones.
- The Activate for all zones option allows the user to apply the delay to all zones (including those previously configured not to activate the output group).

### Per zone (sounder, fire routing, fire protection, or program)

Select the Per zone option to activate output groups with different delays (including no activation) depending on which zone generated the alarm.

All outputs assigned to the output group activate depending on alarms in the fire network, in the local range of zones of the panel, and with different delays.

For example, select this option to activate output group number 5 (sounder, fire routing, fire protection, or program) with a delay of 10 seconds for a detector alarm in zone 1 and with a delay of 2 minutes for a detector alarm in zone 5.

### To configure per zone delay options:

1. Select Field setup from the Main menu, and then select Activation configuration.
2. Select Per zone.
3. Select the zone, and then select the output group whose delay you want to configure for the selected zone.

The corresponding output group configuration options for the selected zone are displayed on the screen.

4. Select Active, and then select YES or NO to define output group activation for the zone.
5. Enter the required delay in minutes and seconds.

The maximum delay value for sounder, fire routing, and fire protection output groups is 10 minutes. The maximum delay value for program output groups is 16 minutes and 40 seconds.

6. If required, enter a warning delay (in minutes and seconds) for sounder output groups in applications using warning tones (second stage sounders).

A warning delay is only observed if the corresponding warning time is also configured (see “Warning time” on page 97 for more information on this option). The maximum warning delay value is 10 minutes.

7. Press F4 (Enter), and then press F1 (Back).
8. Press F1 (Save), F3 (Apply), F4 (Discard), or F2 (Exit).

Remember to apply saved settings from the Main menu.

Outputs assigned to an output group (for example, output group 5 SND) are activated depending on alarms in the fire network and with the corresponding delays.

For example, if we have a one-loop control panel with the initial zone set to 100 and we want to configure sounder output group number 5, the following can be configured with this option:

- No activation for zones 100 to 119
- Activation with a 10 second delay for zones 120 to 139
- Activation with no delay for zones 140 to 163
- No activation for remote zones (in this example, zones 1 to 99 and zones 164 to 9999 are remote zones). Remote zones are indicated as REMT on the LCD.

This programmed output activation can be configured with the Configuration Utility (recommended) or via the Activation configuration menu at the control panel.

### General delays

Select the General delays option to configure region-specific investigation times or advanced delay options.

Configurable options for general delays are shown in the table below.

**Table 54: Configurable options for general delays**

Field	Description
InvMode	Investigation mode. Enables regional investigation time modes (maximum acknowledgement time, extended fire routing delay).
Time	Investigation time. Configures regional investigation time delays (maximum acknowledgement time, extended fire routing delay).
WrnTime	Warning time. Configures the warning time when the control panel is configured to use a warning tone for a second stage sounders application. For standard applications with no warning tone requirement, this time must be 0.
WrnT_4E	Warning time (extended). If checked, the warning tone (where configured) will change to the evacuation tone only if a manual call point alarm is detected.
SdSilDT	Sounder silence disable time. Disables silencing sounders with the Sounder Start/Stop button for a preconfigured time when a sounder delay is running.

**To configure general delays:**

1. Select Field setup from the Main menu, and then select Activation configuration.
2. Select General delays.
3. Select Investigation mode, and then select the type of investigation mode required.

See “Investigation mode” below for more information on this option.

4. If an investigation mode is selected, select Time, and then enter the time value (in seconds).

See “Investigation time” on page 97 for more information on this option.

5. If warning tones are required (for second stage sounders), select Warning time, and then enter the time value (in seconds).

Check the WrnT\_4E check box to change from the warning tone to evacuation tone only if a manual call point alarm is detected.

If a delay is required before the warning tone begins, configure the warning delay for the corresponding output group.

See “Warning time” on page 97 for more information on this option.

6. Select Sounders silence disable time, and then enter the value (in seconds).

The default delay is 60 seconds. The minimum delay is 0 seconds (this configuration is not recommended). The maximum delay should be lower than the minimum configured sounders delay.

See “Sounders silence disable time” on page 98 for more information on this option.

7. Press F4 (Enter), and then press F1 (Back).
8. Press F1 (Save), F3 (Apply), F4 (Discard), or F2 (Exit).

Remember to apply saved settings from the Main menu.

**Investigation mode**

Select the Investigation mode option to define a regional investigation mode for the control panel. The available options are shown in the table below. The default setting is NO (no investigation mode is required).

**Note:** For fire routing investigation modes, in the event of several fire routing groups, the extended delay applies only to the groups in delay when the alarm is acknowledged by the user.

**Table 55: Regional investigation time modes**

<b>Setting</b>	<b>Description</b>
NO (default)	No investigation mode is required.
MAX_ACK_T	<p>Maximum acknowledgement time.</p> <p>The configured investigation time starts to count down when the control panel reports a detector alarm.</p> <p>If the alarm is acknowledged during the investigation time (by pressing the Panel Silence button), then any sounder or fire routing delays continue to be processed as configured. If a new zone reports an alarm after the control panel is silenced, the panel starts another acknowledgement time period.</p> <p>If the alarm is not acknowledged during the investigation time (by pressing the Panel Silence button), then sounders and fire routing are activated when the configured investigation time elapses.</p>
FREXT_ACK	<p>Extended fire routing delay (typically for Scandinavia).</p> <p>The configured fire routing delay starts to count down when the control panel reports a detector alarm.</p> <p>If the alarm is acknowledged during the configured fire routing delay (by pressing the Panel Silence button), then the extended fire routing delay becomes the active delay.</p> <p>If the alarm is not acknowledged during the configured fire routing delay (by pressing the Panel Silence button), then the extended fire routing delay is not activated.</p>
FREXT_SND [1]	<p>Extended fire routing delay (typically for Holland).</p> <p>The standard fire routing delay starts to count down when the control panel reports a detector alarm.</p> <p>If the alarm is acknowledged during the configured fire routing delay (by pressing the Sounders Start/Stop button), then the extended fire routing delay becomes the active delay.</p> <p>If the alarm is not acknowledged during the configured fire routing delay (by pressing the Sounders Start/Stop button), then the extended fire routing delay is not activated.</p>

[1] Sounder delay must be configured as 0 seconds for this option.

## Investigation time

Select the Investigation time option to configure the duration (in seconds) of the investigation time for the configured investigation mode. Minimum, maximum, and default values for each mode are shown in the table below.

**Table 56: Investigation time values per mode**

Investigation mode	Minimum	Maximum	Default
Manual acknowledgement time	30 seconds	See note [1]	60 seconds
Extended fire routing delay (for Scandinavia)	See note [2]	600 seconds	60 seconds
Extended fire routing delay (for Holland)	See note [2]	600 seconds	60 seconds

[1] The maximum value must be less than the minimum delay to activate a sounder or fire routing group.

[2] The minimum value must be greater than the maximum activation delay for any fire routing group.

## Warning time

Select the Warning time option to configure a warning time for applications with warning tone requirements (second stage sounders).

**Note:** If a warning delay is required, this must be configured separately (see “Sounder, fire routing, fire protection, and program output group delays” on page 91).

With this option, sounders emit the warning tone for a configured period of time (the warning time). When the warning time ends, the sounder tone changes to the evacuation tone (the warning tone continues to sound for the duration of any configured delay that precedes the evacuation tone). See Figure 24 and Figure 25 on page 98, below, for examples of delays with and without second stage requirements.

**Note:** The sounder tones are configured in the corresponding device configuration screen.

There are three configurable time periods, as shown in the table below.

**Table 57: Warning time, warning delay, and delay**

Time period	Description
Warning time	The time from when the alarm is reported until the sounders activate the evacuation tone (or the corresponding evacuation tone delay starts to count down)
Warning delay [1]	The optional delay before the sounders activate the warning tone
Delay [1]	The optional delay before the sounders activate the evacuation tone

[1] To configure these values, see “Sounder, fire routing, fire protection, and program output group delays” on page 91.

**Figure 24: Detector alarm with second stage delay**

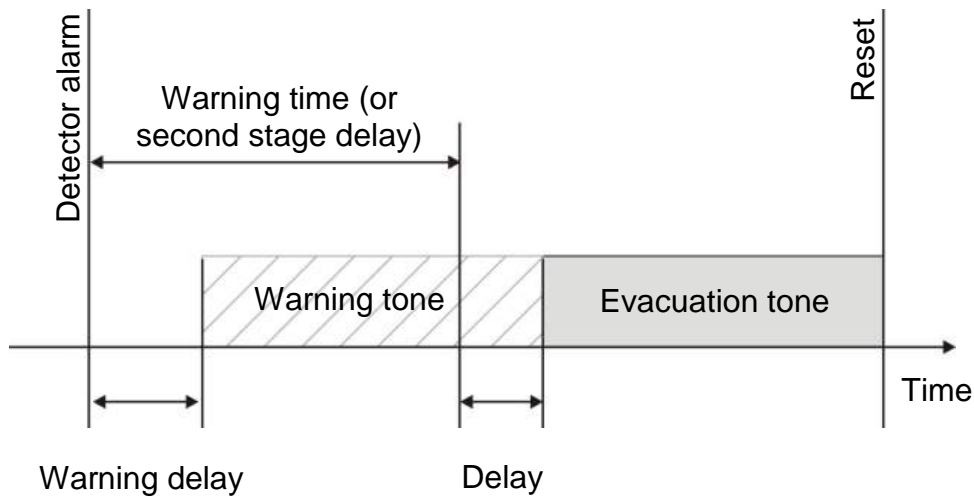

**Figure 25: Detector alarm with standard delay (no second stage)**

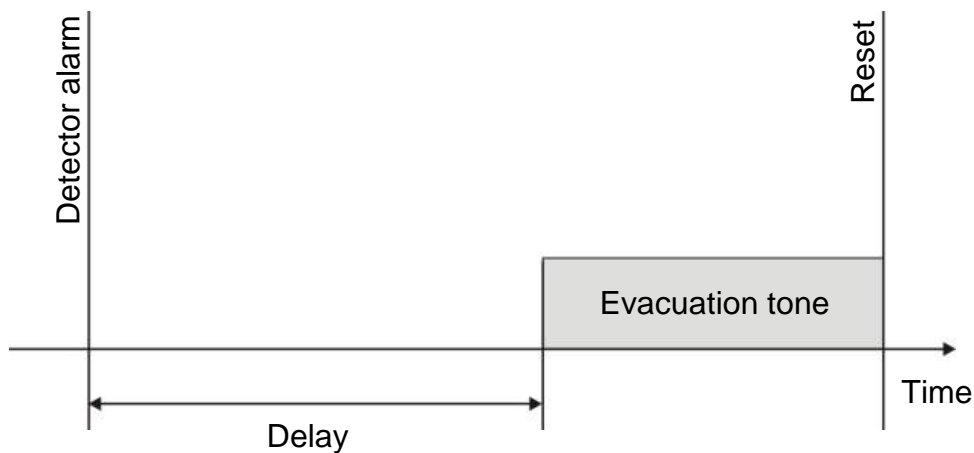

**Sounders silence disable time**

**Note:** The "sounders silence disable time" feature is only available for control panels operating in EN 54-2 mode. For control panels in EN 54-2 Evacuation or NBN S21-100 modes, any configured sounder silence disable times are ignored.

To prevent the immediate silencing of sounders when an alarm is first reported, the Sounder Start/Stop button may be temporarily disabled for a preconfigured period of time when a configured sounder delay is counting down. The default disable time for the Sounders Start/Stop button is 60 seconds.

The disable time starts to count down when the control panel enters alarm status and the configured sounder delay starts.

During the configured disable time the Sounder Start/Stop LED is off and the sounders cannot be silenced (before activation) by pressing the Sounder Start/Stop button.

In the time between the end of the configured disable time and the end of the configured sounder delay (when the Sounder Start/Stop LED is flashing), pressing the Sounder Start/Stop button silences sounders (before activation).



A configured sounder delay may still be cancelled while the delay is running (and sounders activated) by pressing the Sounder Delay button.

## Loop Class configuration

Select the Loop Class option to configure the installation loop Class (Class A or Class B). The default setting is Class A.

### To configure a loop as Class A or Class B:

1. Select Field setup in Main menu.
2. Select Loop Class and select the loop number (1 for one-loop panel; 1 or 2 for two-loop panel, etc.).
3. Select Class A or Class B.
4. Press F4 (Enter), and then press F1 (Back).
5. Press F1 (Save), F3 (Apply), F4 (Discard), or F2 (Exit).

Remember to apply saved settings from the Main menu.

## Tests

### Diagnostics

Select Diagnostics options for tools to support troubleshooting during installation. The diagnostics tests available are shown in the table below.

**Table 58: Diagnostics options**

Option	Description
Individual device	Polls loop devices and retrieves raw data for device diagnostics.  Important: This option alters the normal detection scan to only poll the device under test. This means that no alarms are reported by the system while this test is being performed.
Outputs current	Displays current consumption values for the control panel outputs
Power supply	Displays parameters for the control panel power supply and batteries
Loop values	Displays the voltage and current consumption values for the control panel loops

### To activate a diagnostics test:

1. Select Test in the Main menu, and then select Diagnostics.
2. Select the diagnostics test you require.

If the individual device test is selected, enter the loop and address details for the device to be inspected (for example, 1.089 for device 89 on loop 1).

3. When the test is completed, exit the diagnostics menu to return the control panel to normal operation.

## Individual device diagnostics

Individual device diagnostics options are shown in the table below. Where a polling mode is not supported by a device, the panel uses the default polling mode.

**Note:** Detailed device diagnostics may be requested by your regional technical support office to help troubleshoot technical issues. Use the following tests as instructed by the technical support team and give the test results to them for further analysis and assistance.

**Table 59: Individual device diagnostics tests**

Polling mode	Description
STA	Configures status polling mode
AV1 (default)	Configures analogue value 1 polling mode
AV2	Configures analogue value 2 polling mode
GRP	Configures group status polling mode

Individual device diagnostics values are shown in the table below.

**Table 60: Individual device diagnostics values**

Value	Description
Val1	First type value (slot 1)
Val2	Second type value (slot 2)
Val3	Third type value (slot 3)
Val4	Analogue value 1 (slot 5) [1][2]
Val5	Analogue value 2 (slot 6) [1]

[1] The analogue values displayed are the raw binary values received from the device.

[2] In the event of a line reference fault, Val4 displays 0xFF and the line reference value is shown in Val5.

## Password setup

Use the Password setup menu to change your password and to manage user accounts (operator, maintenance, or installer).

### Changing your password

Select this option to change your password.

#### To change your password:

1. Select Password setup from the Main menu, and then select Change password.
2. Enter your current password.

3. Enter and then confirm your new password.
4. Press F4 (Enter), and then press F1 (Back).
5. Press F1 (Save), F3 (Apply), F4 (Discard), or F2 (Exit).

Remember to apply saved settings from the Main menu.

### **Managing users**

Select the Manage users option to edit, delete, or create operator, maintenance, or installer user accounts. The control panel allows for a maximum of 20 user accounts (all user levels combined).

#### **To edit a user account:**

1. Select Password setup from the Main menu, and then select Manage users.

A list of all user accounts is displayed.

2. Select the user account you want to edit.
3. Select the information to be edited and enter the change.

To change the user password you need to re-enter your installer password, and then allocate and confirm the new user account password.

4. Press F4 (Enter), and then press F1 (Back).
5. Press F1 (Save), F3 (Apply), F4 (Discard), or F2 (Exit).

Remember to apply saved settings from the Main menu.

#### **To delete a user account:**

1. Select Password setup from the Main menu, and then select Manage users.

A list of all user accounts is displayed.

2. Select the user account you want to delete.
- You cannot delete the default user accounts
3. Press F4 (Delete) to delete the selected account.

4. Press F4 (Enter), and then press F1 (Back).
5. Press F1 (Save), F3 (Apply), F4 (Discard), or F2 (Exit).

Remember to apply saved settings from the Main menu.

#### **To create a new user account:**

1. Select Password setup from the Main menu, and then select Manage users.
2. Press F3 (New) to create a new account.
3. Enter a username, a password, and a user level for the new account.

Username help to identify user session activity in the event log.

4. Press F4 (Enter), and then press F1 (Back).

5. Press F1 (Save), F3 (Apply), F4 (Discard), or F2 (Exit).

Remember to apply saved settings from the Main menu.

### **Secure access**

Select the Secure access option to configure the control panel to allow secure or nonsecure access. The default setting is for secure access (all username and password information must be entered at each login).

- If nonsecure access is selected, the control panel automatically prefills the last username and password combination entered for login
- If secure access is selected, all username and password information must be entered at each login

### **To configure the security setting:**

1. Select Password setup from the Main menu, and then select Secure access.
2. Select the required security setting.
3. Press F4 (Enter), and then press F1 (Back).
4. Press F1 (Save), F3 (Apply), F4 (Discard), or F2 (Exit).

Remember to apply saved settings from the Main menu.

## **Commissioning**

After the control panel and corresponding devices are installed and configured, the system must be commissioned.

Check the following:

- That the fire system is designed in accordance with all required regulations and standards
- That the maximum alarm current in your installation does not exceed the maximum current specifications of the power supply
- That all equipment is correctly installed and tested and that all cabling complies with the recommendations outlined in “Recommended cables” on page 24
- That all software functions are correctly programmed
- That all installed detectors are appropriate for installation environment and operate correctly
- That all inputs and outputs operate correctly
- That any input/output logic (rules and actions) configuration is correct
- That the fire system is functioning correctly in standby and is not reporting any alarms or faults

- That under the alarm conditions (with all applicable devices activated), the current consumption does not exceed the power supply specifications (if the batteries are not activated the current consumption is within the specifications)



# Chapter 4

# Maintenance

## **Summary**

This chapter includes information on fire alarm system and battery maintenance.

## **Content**

Fire alarm system maintenance 106

Battery maintenance 107

## Fire alarm system maintenance

To ensure correct functioning of your control panel and fire alarm system, and compliance with all European regulations, the following maintenance checks should be followed.

---

**Caution:** Ensure that fire routing (where configured) has been disabled or that the fire brigade has been notified of any planned fire alarm tests.

---

### Quarterly maintenance

Contact your installation or maintenance contractor to carry out a quarterly inspection of the fire alarm system.

This must test at least one device per zone and verify that the control panel responds to all fault and alarm events.

The control panel power supply should be checked and the batteries tested using the “Battery test” menu option (see “Battery test fault indications” on page 107).

### Annual maintenance

Contact your installation or maintenance contractor to carry out an annual inspection of the fire alarm system.

This must test all system devices and verify that the control panel responds to all fault and alarm events. All electrical connections must be visually inspected to make sure that they are securely fastened, that they have not been damaged, and that they are appropriately protected.

### Cleaning

Keep the outside and inside of the control panel clean. Carry out periodic cleaning using a damp cloth for the outside. Do not use products containing solvents to clean the unit. Do not clean the inside of the cabinet with liquid products.



## Battery maintenance

The control panel requires two 12 V, rechargeable, sealed lead-acid batteries with 7.2, 12, or 18 Ah capacity. Compatible batteries for this product are shown in Table 61 below.

Batteries are located inside the control panel cabinet and must be installed in series. Polarity must be observed. Connect batteries to the BAT connector on the control panel PCB.

**Table 61: Compatible batteries**

Battery type	Recommended batteries
12 V, 7.2 Ah	UTCFS BS127N Fiamm FG20721/2 Yuasa NP7-12
12 V, 12 Ah	UTCFS BS130N Fiamm FG21201/2 Yuasa NP12-12
12 V, 18 Ah	UTCFS BS131N Fiamm FG21703 Yuasa NP17-12

### Battery test fault indications

A flashing Supply Fault LED indicates a battery fault or a battery cable fault. Additional information for the fault is displayed on the LCD, as shown below.

**Table 62: Battery fault messages**

LCD message	Description
Battery high resistance FLT	The batteries may be damaged or fully discharged
Battery fault	The batteries may be damaged
Battery disconnected	The batteries are disconnected or no batteries are installed
Battery short circuit	There is a battery cable short circuit

If the control panel reports any of the above battery faults, check the battery cables. If the cables are in good condition and all connections are correct, then the batteries should be replaced immediately.

In addition to the above, the following battery charger faults may display:

- Battery charger: sensor HI
- Battery charger: sensor LO
- Battery charger: overvoltage
- Battery charger: undervoltage
- Battery charger: compensation

## Replacing batteries

Batteries must be replaced periodically as recommended by the manufacturer. The useful life of the battery is approximately 4 years. Avoid the total discharge of the batteries. Always use the recommended replacement batteries.

### To replace the batteries:

1. Remove the battery bridge.
2. Disconnect and remove the existing batteries from the cabinet.
3. Install and connect the replacement batteries using the bridge provided. Observe the correct polarity.
4. Dispose of the battery as required by local ordinances or regulations.

### Battery start-up

The battery start-up option may be required after replacing batteries after a low battery indication when mains power is not available.

To power up the control panel from the batteries, press the battery start button on the control panel PCB (marked as BAT, see Figure 26 below). Keep the button pressed for approximately 5 seconds.

Figure 26: Battery start-up button

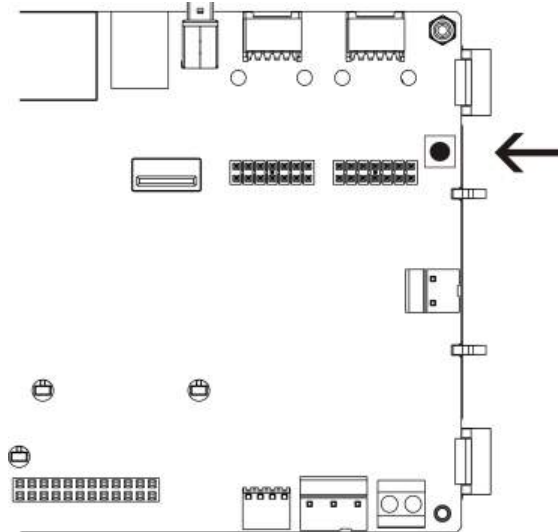

# Chapter 5

## Technical specifications

### Summary

This chapter provides technical specifications for your control panel.

### Content

Loop specifications	110
Power supply specifications	110
Battery and battery charger specifications	111
LCD specifications	111
Communication port specifications	112
Fire network specifications	112
Input and output specifications	112
Internal printer specifications	113
Mechanical and environmental specifications	114

## Loop specifications

Loop configuration	Class A or Class B
Loop protocol	Ziton
Isolators	At least one isolator per loop (we recommend one isolator for every 32 devices)
Number of loop devices	127 max.
Electrical characteristics – maximum per loop	300 mA at 11 VDC (peak 500 mA at 20 VDC)
Resistance	75 $\Omega$ max. (based on 3.5 km max. cable length with 2 mm <sup>2</sup> diameter for up to 127 devices)
Capacitance	700 nF max.

## Power supply specifications

Mains voltage	240/110 VAC +10% -15%
Mains frequency	50/60 Hz $\pm$ 5%
Mains current	
Maximum	1.5 A at 240 VAC 3.15 A at 110 VAC
Average	0.6 A at 240 VAC 1.3 A at 110 VAC
CIE input voltage and current (mains on)	24 VDC, 4 A
Power (mains on)	137 VA (24 VDC, 4 A)
CIE input voltage (mains off)	21 to 29 VDC
Maximum ripple at full load	150 mVpp  <b>Note:</b> Ripple and noise are measured at 20 MHz of bandwidth by using a 12-inch twisted-pair wire terminated with a 0.1 $\mu$ F and 47 $\mu$ F parallel capacitor.
Mains fuse	T4A-250V at 240 VAC T4A-250V at 110 VAC
Typical control panel current consumption (with no devices connected)	
One-loop control panel	135 mA at 24 VDC
Two-loop control panel	155 mA at 24 VDC
Two-loop control panel with printer	220 mA at 24 VDC
Repeater panel	110 mA at 24 VDC

Typical expansion board current consumption	
Network board	50 mA at 24 VDC
DACT board	45 mA at 24 VDC
DACT board (with GPRS board)	100 mA at 24 VDC
Loop board [1]	50 mA at 24 VDC
Peripherals boards [1]	
2010-2-PIB	26 mA at 24 VDC
2010-2-PIB-8I	25 mA at 24 VDC
2010-2-PIB-8O	16 mA at 24 VDC
2010-2-PIB-8I8O	26 mA at 24 VDC
Zone LED boards	
20/24-zones	12 mA at 24 VDC
40-zones	14 mA at 24 VDC
Quiescent current (I <sub>max a</sub> )	2.5 A max. at 24 VDC
Alarm current (I <sub>max b</sub> )	4 A max. at 24 VDC

[1] No loads connected.

## Battery and battery charger specifications

For recommended battery specifications, see “Battery maintenance” on page 107.

Type	Sealed lead-acid batteries (2X)
Battery charging voltage	27.3 V at 20°C – 36 mV/°C
Battery charging current	1.2 A max.
Low battery indication	23.6 VDC ± 1% at 25°C <b>Note:</b> Additional 0.2 V (max.) drop if I <sub>max b</sub> current in battery cables.
System shutdown warning	21.5 VDC ± 1% at 25°C
System shutdown (for battery protection)	21 VDC ± 1% at 25°C

## LCD specifications

Display type	240 x 128 dot graphic LCD (monochromatic)
LCD dimensions (L x W)	83 x 44 mm (active area)
Backlight type	LED style
Backlight colour	White

## Communication port specifications

Ethernet	Ethernet 10/100BaseT port (10 Mbps) <b>Note:</b> For increased security, we recommend against using Ethernet for remote connection to the control panel via the Internet.
TCP/IP	IPv4
USB host port	USB 2.0, type A connector
USB device port	USB 2.0, type B connector

## Fire network specifications

Maximum distance between two control panels	1.2 km
Maximum capacity	32 loops and 32 nodes
Communication protocol	Proprietary protocol based on RS-485

## Input and output specifications

### Input and output overview

	Configurable outputs	General fire outputs	General fault outputs	24V AUX output	Configurable inputs
One-loop panel	2 Class B 1 Class A	2 (see note)	2 (see note)	1	2
Two-loop panel	4 Class B 2 Class A	2 (see note)	2 (see note)	1	2
Two-loop panel with loop board	8 Class B 4 Class A	2	2	1	2
Repeater panel	0	2	2	1	2

Note: 1 supervised output and 1 potential-free relay.

### Configurable inputs

Number of inputs	2 supervised inputs, end-of-line resistor 15 k $\Omega$ , 1/4 W
Active value	60.2 $\Omega$ $\leq$ active value $\leq$ 8 k $\Omega$
Normal value	10 k $\Omega$ $\leq$ value $\leq$ 20.2 k $\Omega$
Short circuit values	$\leq$ 60.2 $\Omega$
High-impedance fault value	8 k $\Omega$ < value < 10 k $\Omega$
Open circuit values	$\geq$ 20.2 k $\Omega$
Configurable options	See Table 46 on page 83

<b>Configurable outputs</b>	
Supervision (Class B outputs)	Reverse polarity, end-of-line resistor 15 k $\Omega$ , 1/4 W
Supervision (Class A outputs)	Reverse polarity, end-of-line resistor 4.7 k $\Omega$ , 1/4 W
Maximum output current	750 mA per output at 25 °C 600 mA per output at 40°C (small cabinet) 675 mA per output at 40°C (large cabinet)
Maximum electrical characteristics for sounder activation	1 A start-up current ( $t \leq 2\text{ms}$ ), load 100 $\mu\text{F}$
Configurable options	See Table 48 on page 86
<b>Fire and fault outputs</b>	
Available output pairs	1 output pair for Fire 1 output pair for Fault (activated when no fault)
Output pair specifications	1 supervised output: reverse polarity, end-of-line resistor 15 k $\Omega$ , 1/4 W 1 potential free relay: C/NO/NC
Maximum output current	
Supervised output	350 mA per output for all temperature ranges
Relay output	2 A / 30 VDC
<b>24V auxiliary output</b>	
Maximum output current	500 mA at 25°C 385 mA at 40°C
Configurable options	Resettable, not deactivated during reset (default), inactive when mains off, not deactivated when running on batteries (default)

## Internal printer specifications

**Note:** The internal printer is only available on selected models.

Printing method	Thermal
Resolution	203 dpi (8 dots/mm)
Printing speed	>50 mm/s
Columns	24/40
Paper width	58 mm
Paper weight	55 to 70 g/m <sup>2</sup>
Roll dimension	Ø 30 mm max.
Character set	ASCII standard, EPSON, International
Data buffer	128 bytes
Flash memory	32 KB
Operating temperature	0 to 50°C

## Mechanical and environmental specifications

---

### Mechanical

---

#### Cabinet dimensions (L x W x H)

Small cabinet	410 x 162 x 298 mm
Large cabinet	450 x 173 x 550 mm

---

#### Weight (without batteries)

Small cabinet	5.2 kg
Large cabinet	7.4 kg

---

#### Number of cable knockouts

Small cabinet	9 x Ø 20 mm at top of cabinet 2 x Ø 20 mm at bottom of cabinet
Large cabinet	18 x Ø 20 mm at top of cabinet 2 x Ø 20 mm at bottom of cabinet

---

IP rating	IP30
-----------	------

---

### Environmental

---

Operating temperature	-5 to +40°C
-----------------------	-------------

---

Storage temperature	-20 to +50°C
---------------------	--------------

---

Relative humidity	10 to 95% noncondensing
-------------------	-------------------------

---



Figure 27: Large cabinet dimensions and views

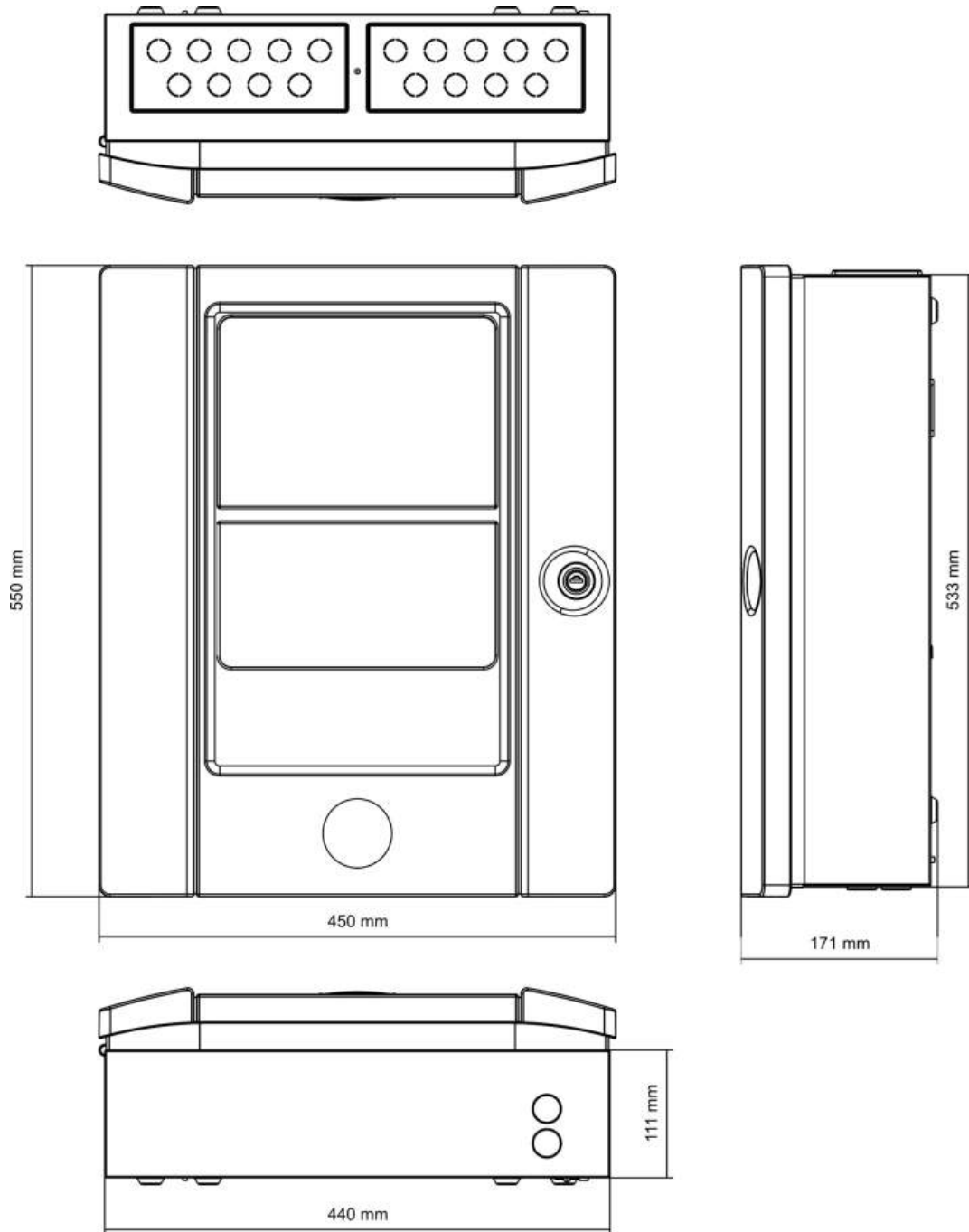
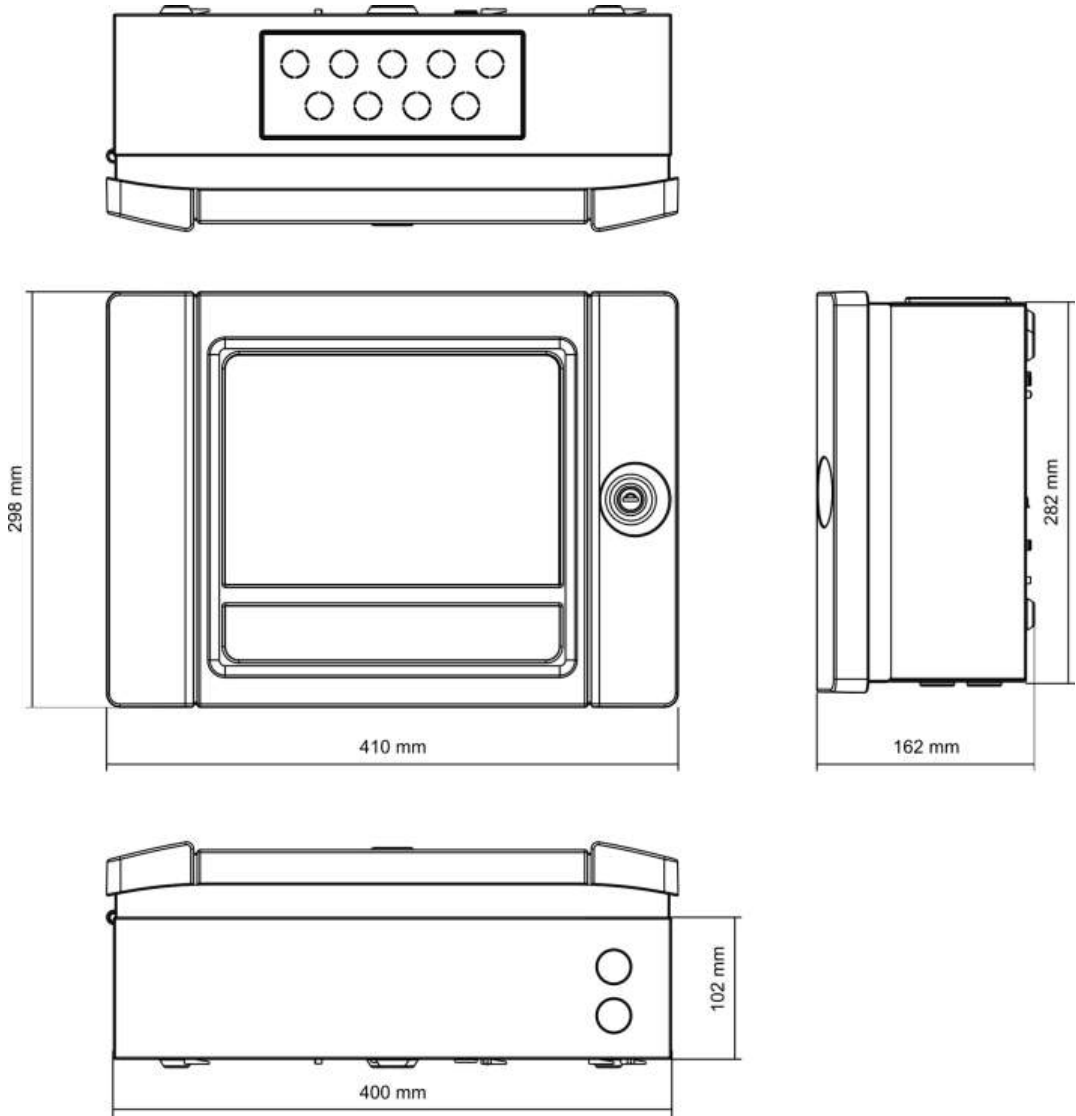

Figure 28: Small cabinet dimensions and views



# Appendix A

## Default configurations

The following table shows the settings for the default configuration of your panel.

**Table 63: Default configurations**

<b>Description</b>	<b>Default setting</b>
Power supply operation	230 VAC
Control panel ID	01
Day/night mode	Full day to day mode
Control panel network operation	Stand-alone
Network global commands	Yes
Network mask	0 (all panels excluded from the mask)
Repeater panel network operation	Repeater
Repeater mask	All panels repeated
IP address	192.168.104.140
Subnet mask	255.255.255.0
Gateway	0.0.0.0
Port	2505
24V auxiliary	Not deactivated during reset, not deactivated when running on batteries
Fault mask	All faults are reported
Sounders re-sound	Sounders re-sound
Expansion boards for repeater panels	Network board is configured
Initial zone	1
Autosetup zone	All detectors, manual call points, and zone modules to the initial zone All sounders to output group 1 (sounders) All relay/non-supervised outputs to output group 301 (program) All extinguishing modules to output group 801 (extinguishing) All inputs configured as technical alarm latched

<b>Description</b>	<b>Default setting</b>
OUT1, OUT2, etc. (Class B)	Sounder output (all zones)
Fire output	Activated by fire alarms in all zones
Fault output	Follows the General Fault LED and is activated when there is no fault (fail-to-safe)
IN1 and IN2	Technical alarm latched (T_AL)
Delays	All delays to 0 in all zones Sounder, fire routing, fire protection, and program groups to be activated by all zones Sounders silence disable time 60 seconds
Expansion boards	None

# Appendix B

## PSTN country codes

Use the PSTN country codes in the table below when configuring DACT board settings.

**Table 64: PSTN country codes**

Country	Code	Country	Code	Country	Code
Algeria	0	Greece	34	Paraguay	70
Argentina	1	Guadeloupe	35	Peru	71
Armenia	2	Guam	36	Philippines	72
Australia	3	Hong Kong	37	Poland	73
Austria	4	Hungary	38	Polynesia	74
Bahamas	5	Iceland	39	Portugal	75
Bahrain	6	India	40	Puerto Rico	76
Belarus	7	Indonesia	41	Qatar	77
Belgium	8	Ireland	42	Reunion	78
Bermuda	9	Israel	43	Romania	79
Brazil	10	Italy	44	Russia	80
Brunei	11	Japan	45	Saudi Arabia	81
Bulgaria	12	Jordan	46	Singapore	82
Canada	13	Kazakhstan	47	Slovakia	83
Caribbean	14	Korea	48	Slovenia	84
Chile	15	Kuwait	49	South Africa	85
China	16	Kyrgyzstan	50	Spain	86
Colombia	17	Latvia	51	Sri Lanka	87
Costa Rica	18	Lebanon	52	Sweden	88
Croatia	19	Lesotho	53	Switzerland	89
Cyprus	20	Liechtenstein	54	Syria	90
Czech Republic	21	Lithuania	55	Taiwan	91
Denmark	22	Luxembourg	56	Thailand	92
Dominican Rep.	23	Macau	57	Tunisia	93

<b>Country</b>	<b>Code</b>	<b>Country</b>	<b>Code</b>	<b>Country</b>	<b>Code</b>
Dubai	24	Malaysia	58	Turkey	94
Equador	25	Malta	59	UAE	95
Egypt	26	Martinique	60	Ukraine	96
El Salvador	27	Mexico	61	UK	97
Estonia	28	Moldova	62	Uruguay	98
Finland	29	Morocco	63	USA	99
France	30	Netherlands	64	Uzbekistan	100
Georgia	31	New Zealand	65	Venezuela	101
Germany	32	Nigeria	66	Yemen	102
Ghana	33	Norway	67	Zambia	103
Greece	34	Oman	68		
Guadeloupe	35	Pakistan	69		

# Appendix C

## Menu maps

### Fire alarm control panels

#### Maintenance user level

Menu level 1	Menu level 2	Menu level 3
Panel setup	Date and time	
	Day/Night mode	Day/Night schedule
		Holiday calendar
		Day/Night setup
	Communications	Email accounts
		Remove USB device
Disable/Enable	Zones	
	Devices	
	Panel outputs	
	Panel inputs	
	Output groups	
	Remote disable	
Test	Zone test	
	Output test	Panel outputs
		Loop outputs
	Output group test	
	Locate device	
	Service mode	
	Remote test	
	UI test	Indicators test
		Keyboard test
LCD test		
	Battery test	

Menu level 1	Menu level 2	Menu level 3
Reports	Event log	View all
		Clear
	Attention required	
	Revision	Firmware revision
		Configuration revision
		Serial numbers
	Contact details	
	Zone status	
	Zone mapping	
	Device status	
	Panel I/O status	
	Output groups status	
	Rules status	
	Firenet status	
	Save reports	All
		Current events
		Event log
		Attention required
		Zone status
Device status		
Panel I/O status		
Output groups status		
Rule status		
Firenet status		
Alarm counter		
Password setup	Change password	
	Manage users	

### Installer user level

Menu level 1	Menu level 2	Menu level 3
Field setup	Autosetup	
	Loop device configuration	
	Zone configuration	General configuration
		Zone configuration
		Area configuration
Panel I/O configuration	Panel inputs	



Menu level 1	Menu level 2	Menu level 3
		Panel outputs
	Output groups	Group configuration
		Confirmations
		Programmable controls
	Activation configuration	Sounders
		Fire routing
		Fire protection
		Program
		Per zone
		General delays
Loop Class		
Panel setup	ID configuration	
	Date and time	
	Day/Night mode	Day/Night schedule
		Holiday calendar
		Day/Night setup
	Regional options	
	Firenet	Firenet map
		Firenet opmode
		Repeater map
		Global controls
		Event filter
		Command filter
	Communications	Class B
TCP/IP		
Email accounts		
Email server		
	Remove USB device	
Other settings	24V aux. configuration	
	Fault mask	
	Buzzer	
	Re-sound sounders	
	School bells	
	Device LEDs	
	Self-test configuration	
Pulse activation		
Configuration	Restore configuration	

Menu level 1	Menu level 2	Menu level 3
		Load configuration
		Save configuration
		Default configuration
	Expansion boards	
	Load auxiliary files	Splash screens
		Languages
		Language fonts
	Firmware update	
	Printer configuration	Int. printer configuration
		Ext. printer configuration
	DACT configuration	General configuration
		Ethernet configuration
		CMS configuration
PSTN configuration		
GPRS configuration		
Disable/Enable	Zones	
	Devices	
	Panel outputs	
	Panel inputs	
	Output groups	
	Remote disable	
Test	Zone test	
	Output test	Panel outputs
		Loop outputs
	Output group test	
	Locate device	
	Service mode	
	Remote test	
	Diagnostics	Individual device
		Outputs current
		Power supply
Loop values		
UI test	Indicator test	
	Keyboard test	
	LCD test	
Battery test		
Reports	Event log	View all

Menu level 1	Menu level 2	Menu level 3
		Clear
	Attention required	
	Revision	Firmware revision
		Configuration revision
		Serial numbers
	Contact details	
	Zone status	
	Zone mapping	
	Device status	
	Panel I/O status	
	Output groups status	
	Rules status	
	Firenet status	
	Save reports	All
		Current events
		Event log
		Attention required
		Zone status
		Device status
		Panel I/O status
		Output groups status
		Rules status
		Firenet status
Alarm counter		
Password setup	Change password	
	Manage users	
	Secure access	

## Fire alarm repeater panels

### Maintenance user level

Menu level 1	Menu level 2	Menu level 3
Panel setup	Date and time	
	Day/Night mode	Day/Night schedule
		Holiday calendar
		Day/Night setup

Menu level 1	Menu level 2	Menu level 3
	Communications	Email accounts Remove USB device
Disable/enable	Panel outputs Panel inputs Remote disable	
Test	Output test Service mode Remote test UI test	Panel outputs Indicators test Keyboard test LCD test
	Battery test	
Reports	Event log Attention required Revision Contact details Panel I/O status Rules status Firenet status Save reports	View all Clear Firmware revision Configuration revision Serial numbers All Current events Event log Attention required Panel I/O status Firenet status
Alarm counter		
Password setup	Change password Manage users	

### Installer user level

Menu level 1	Menu level 2	Menu level 3
Field setup	Zone configuration Panel I/O configuration	General configuration Panel inputs

Menu level 1	Menu level 2	Menu level 3
		Panel outputs
	Output groups	Programmable controls
	Activation configuration	General delays
Panel setup	ID configuration	
	Date and time	
	Day/Night mode	Day/Night schedule
		Holiday calendar
		Day/Night setup
	Regional options	
	Firenet	Firenet map
		Firenet opmode
		Repeater map
		Global controls
		Event filter
		Command filter
		Class B
	Communications	TCP/IP
		Email accounts
		Email server
		Remove USB device
	Other settings	24V aux. configuration
		Fault mask
		Buzzer
	Configuration	Restore configuration
		Load configuration
		Save configuration
Default configuration		
Expansion boards		
Load auxiliary files	Splash screens	
	Languages	
	Language fonts	
Firmware update		
Printer configuration	Int. printer configuration	
	Ext. printer configuration	
DACT configuration	General configuration	
	Ethernet configuration	
	CMS configuration	

Menu level 1	Menu level 2	Menu level 3	
		PSTN configuration	
		GPRS configuration	
Disable/Enable	Panel outputs		
	Panel inputs		
	Remote reset		
Test	Output test	Panel outputs	
	Output group test		
	Locate device		
	Service mode		
	Remote test		
	Diagnostics		Outputs current
			Power supply
			Loop current
	UI test		Indicators test
			Keyboard test
		LCD test	
Battery test			
Reports	Event log	View all	
		Clear	
	Attention required		
	Revision		Firmware revision
			Configuration revision
			Serial numbers
	Contact details		
	Panel I/O status		
	Firenet status		
	Rules status		
	Save reports		All
			Current events
			Event log
		Attention required	
		Panel I/O status	
		Firenet status	
Alarm counter			
Password setup	Change password		
	Manage users		
	Secure access		

# Appendix D

## Regulatory information

### European standards for fire control and indicating equipment

These control panels have been designed in accordance with European EN 54-2, and EN 54-4 standards.

In addition, they comply with the following EN 54-2 optional requirements.

**Table 65: EN 54-2 optional requirements**

Option	Description
7.8	Output to fire alarm devices [1]
7.9.1	Output to fire alarm routing equipment [2]
7.9.2	Alarm confirmation input from fire alarm routing equipment [2]
7.10	Output to fire protection equipment (type A, B, and C) [3]
7.11	Delays to outputs [4]
7.12	Dependencies on more than one alarm signal (types A, B, and C) [4]
7.13	Alarm counter
8.4	Total loss of the power supply
8.9	Output to fault warning routing equipment
9.5	Disabling of addressable points [4]
10	Test condition [4]

[1] Excluding repeaters and control panels operating in EN 54-2 Evacuation mode or NBN mode.

[2] Excluding repeaters, control panels without fire routing, and control panels with fire routing operating in NBN mode.

[3] Excluding repeaters and control panels without fire protection controls.

[4] Excluding repeaters.

## European regulations for construction products

This section includes both regulatory information and a summary on the declared performance according to the Construction Products Regulation 305/2011. For detailed information refer to the product Declaration of Performance (DoP).

**Table 66: Regulatory information**

Certification	<b>CE</b>
Certification body	0832
Manufacturer	UTC CCS Manufacturing Polska Sp. Z o.o. Ul. Kolejowa 24. 39-100 Ropczyce, Poland  Authorized EU manufacturing representative: UTC Fire & Security B.V., Kelvinstraat 7, 6003 DH Weert, The Netherlands
Year of first CE marking	13
Declaration of Performance number	
One-loop panels	360-3201-0599
Two-loop panels	360-3201-0699
EN 54	EN 54-2: 1997 + A1: 2006 EN 54-4: 1997 + A1: 2002 + A2: 2006
Product identification	See model number on product identification label
Intended use	See DoP point 3
Essential characteristics	See DoP point 9

### EN 54-13 European compatibility assessment of system components

These control panels form part of a certified system as described by the EN 54-13 Standard when installed and configured for EN 54-13 operation as detailed in this manual and when using only the devices identified as EN 54-13 compatible in the compatible products list included with this control panel.

See the installation and configuration chapters of this document for specific installation and configuration requirements to ensure full compatibility with this standard.



### **European standards for electrical safety and electromagnetic compatibility**

These control panels have been designed in accordance with the following European standards for electrical safety and electromagnetic compatibility:

- EN 60950-1
- EN 50130-4
- EN 61000-6-3
- EN 61000-3-2
- EN 61000-3-3



# Index

## A

- acoustic indications, 12
- area configuration, 82
- autosetup, 74

## B

- battery
  - compatible batteries, 107
  - fault indications, 107
  - maintenance, 107
  - replacement, 108
  - start-up, 108
  - test, 49

## C

- cabinet
  - installation, 19
  - layout, 17
- cables, recommended, 24
- Class A loop, 25
- Class A loop (EN 54-13), 26
- command filter, 58
- commissioning checklist, 102
- conditions, 12
- configuration controls, 38
- configuration recommendations, 38
- connections
  - aux. equipment, 29
  - batteries, 32
  - Class A loop, 27
  - Class B loop, 27
  - external printer, ASCII terminal, 34
  - fire network, 32
  - inputs, 28
  - internal printer, 22
  - mains terminal block, 31
  - outputs, 28
  - UI cable, 21
- control panel configuration
  - load, 65
  - restore default, 66
  - restore previous, 64
  - save, 65

- custom screens, 67

## D

- DACT
  - CMS configuration, 71
  - Ethernet configuration, 71
  - GPRS configuration, 73
  - PSTN configuration, 72
- date and time, 40
- day/night mode, 41
- delays
  - activation configuration, 91
  - Alert Cancellation Time (ACT), 81
  - Confirmation Inhibition Time (CIT), 81
  - extended fire routing, 95
  - general delays, 94
  - investigation modes, 95
  - investigation time defaults, 97
  - maximum acknowledgement time, 95
  - output groups, 91
  - per zone, 93
  - second stage delay, 97
  - Sounder Start/Stop button disable, 98
  - warning time, 97
- device
  - add, 75
  - configuration, 75
  - disable, 45
  - disable LEDs, 62
  - enable, 45
  - locate, 48
  - self-test, 63
- diagnostics tests, 99
- disable
  - device, 45
  - input, 85
  - output, 86
  - zone, 79

## E

- email
  - accounts, 60
  - manage accounts, 44
  - server configuration, 60

enable  
 device, 45  
 input, 85  
 output, 86  
 zone, 79  
 event filter, 58  
 event log  
 back up, 50  
 clear, 50  
 view, 50  
 expansion board configuration, 66  
 external printer  
 configuration, 69  
 connection, 34

## F

F1, F2, F3, F4 buttons, 10, 39  
 fault mask, 61  
 fire network  
 bus configuration, 33  
 class configuration, 59  
 ring configuration, 33  
 Firenet  
 configuration options, 55  
 ID configuration, 54  
 map, 56  
 operating mode, 56  
 firmware updates, 68  
 flash drive format, 51

## G

global controls, 57

## H

holiday calendar, 42

## I

ID configuration, 54  
 indications  
 acoustic, 12  
 LED, 6  
 input  
 activation characteristics, 28  
 activation test, 47  
 configuration, 83  
 connections, 28  
 types, 83  
 installer user level, 36  
 internal printer  
 configuration, 69  
 connection, 22  
 loading paper, 23

## L

language files, 67  
 LCD  
 controls, 10  
 icons, 11  
 LED indications, 6  
 loop class configuration, 99

## M

mains power, 30  
 maintenance  
 batteries, 107  
 fire system, 106  
 maintenance reports, 49  
 maintenance user level, 36  
 menu inserts, 20

## O

operator user level, 36  
 output  
 activation test, 47  
 configuration, 85  
 connections, 28  
 polarity, 29  
 pulse activation (fire routing), 64  
 termination, 29  
 types, 86  
 output group  
 activation, 88  
 activation test, 48  
 add new, 88  
 configuration, 88  
 default output groups, 87  
 delayed activation, 89  
 overview, 86

## P

password  
 change, 52, 100  
 secure access, 102  
 timeout period, 37  
 public user level, 36

## R

regional operating modes, 55  
 remote device test, 48  
 repeater map, 57  
 Reports, saving, 51

## S

school bells, 63  
 service mode, 49  
 service mode timeout, 64  
 sounders re-sound, 62

**T**

TCP/IP settings, 59

**U**

USB device, removing, 45

user account

    create new, 53, 101

    delete, 52, 101

    edit, 52, 101

user levels, 36

**Z**

ZI initial zone LED, 78

zone

    add, 76

    alarm confirmation, 79

    alarm confirmation types, 80

    configuration, 75, 79

    disable, 79

    enable, 79

    initial zone, 77

    operating mode, 79, 81

    remote zones, 76

    test, 46

    test/disable timeout, 78

