

## ASSEMBLY & SET UP OF THE - MOON GATE

**Includes**

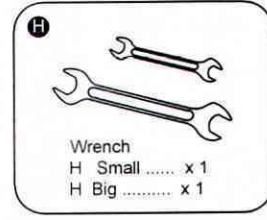

Two people are needed for assembly & set up of Moon Gate Unit. Assemble the complete unit as close to its final location. Once built it is heavy & difficult to move. Assemble the Moon Gate Unit face down on the ground, and follow the steps as shown in pictures :

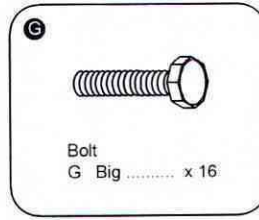
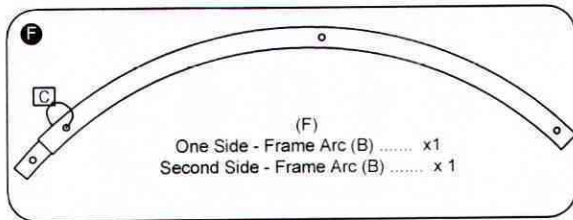
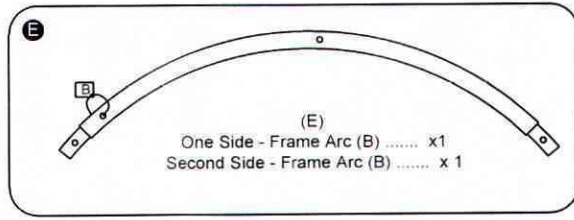
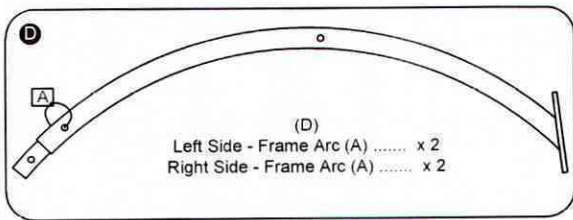
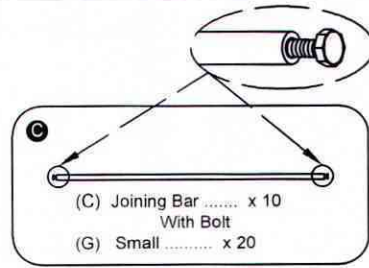
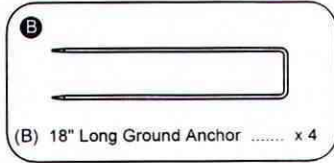
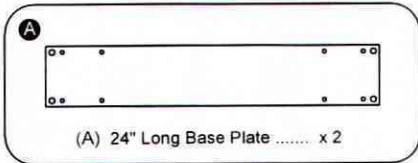
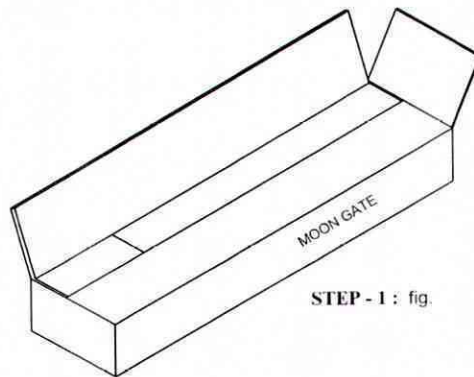

**STEP - 1 :** Unpack your Moon Gate.  
Check all items with the listing charts above.

## ASSEMBLY & SET UP OF THE - MOON GATE

**STEP - 1 :** Keep arc (A),(B),(E),(F), on ground as shown in figure - 1.  
Note paper labels to help you identify and assemble correct pieces.  
Push smaller tube ends into larger sockets, then align drilled holes.

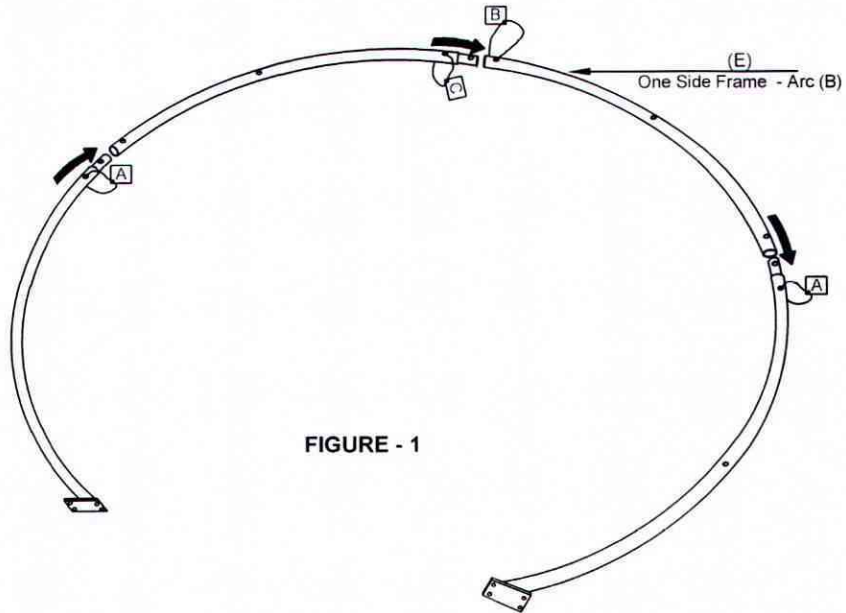

FIGURE - 1

**STEP - 2 :** Take out Pre fitted bolts of joining bars Now insert 12 joining bars through larger holes in joints , until they rest against inside outer walls of tubes. Insert bolts from below into threaded bars and tighten. Refer figure -2 and tighten bolts.

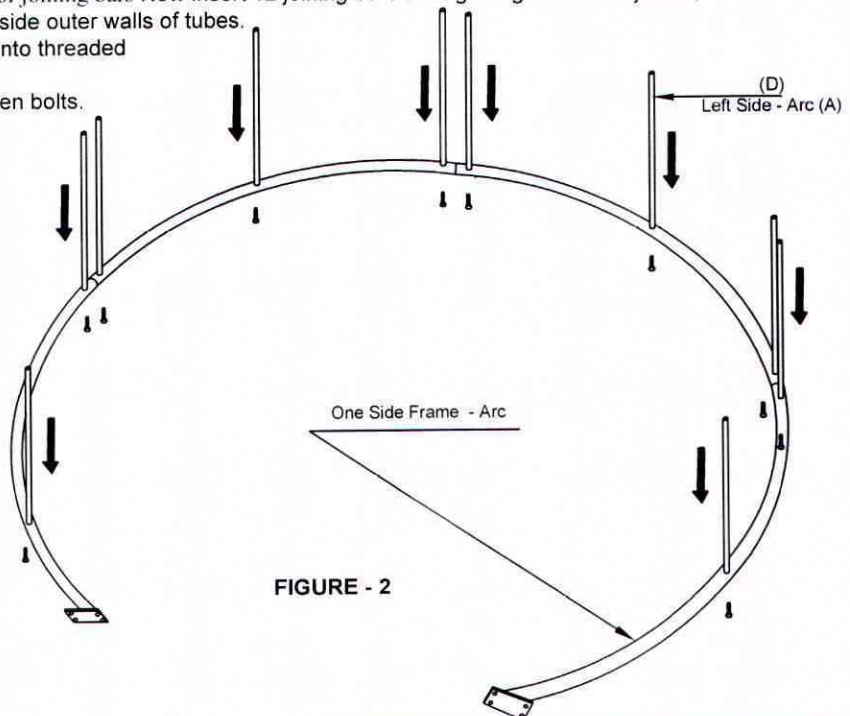

FIGURE - 2

## ASSEMBLY & SET UP OF THE - MOON GATE

**STEP - 3 :** Now, join second curved arch together with help of 2 people , place this second arc on top of joining bars. Insert bolts into internal threads of joining bars, then tighten with wrench. as shown in figure - 3

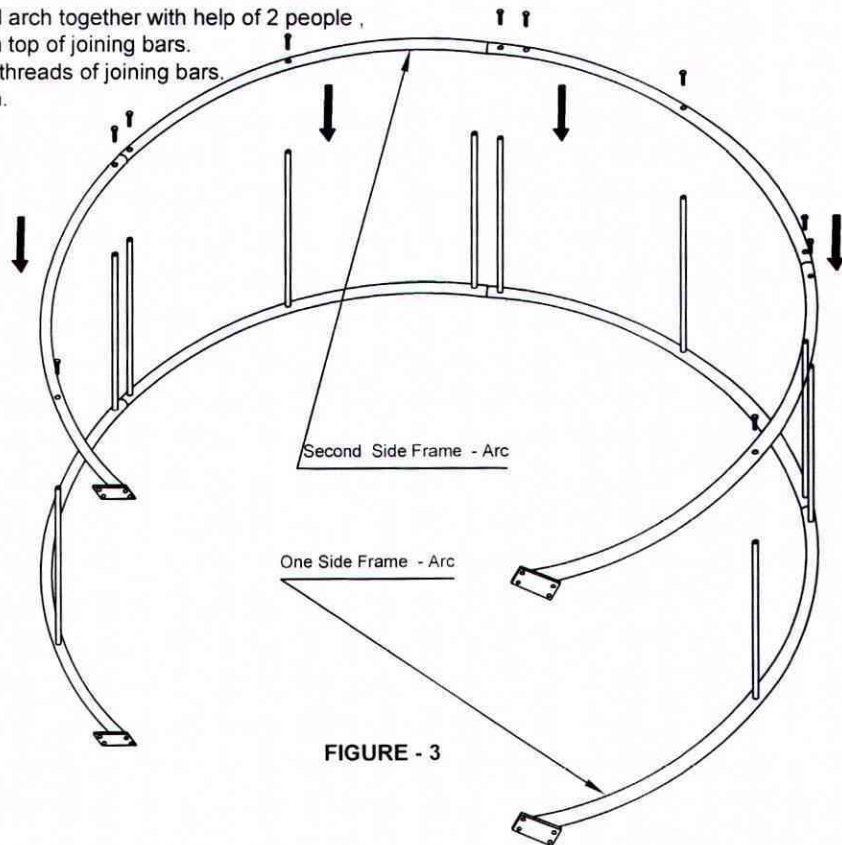

FIGURE - 3

**STEP - 4 :** Stand arch into upright position, fasten end onto base plate. then tighten bolts on base plate, Drive ground anchors through base plate into ground for stability as shown in figure - 4

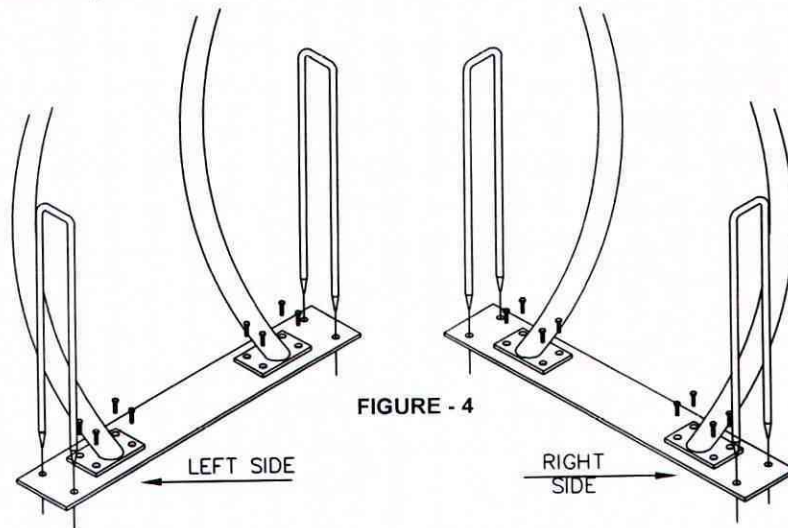
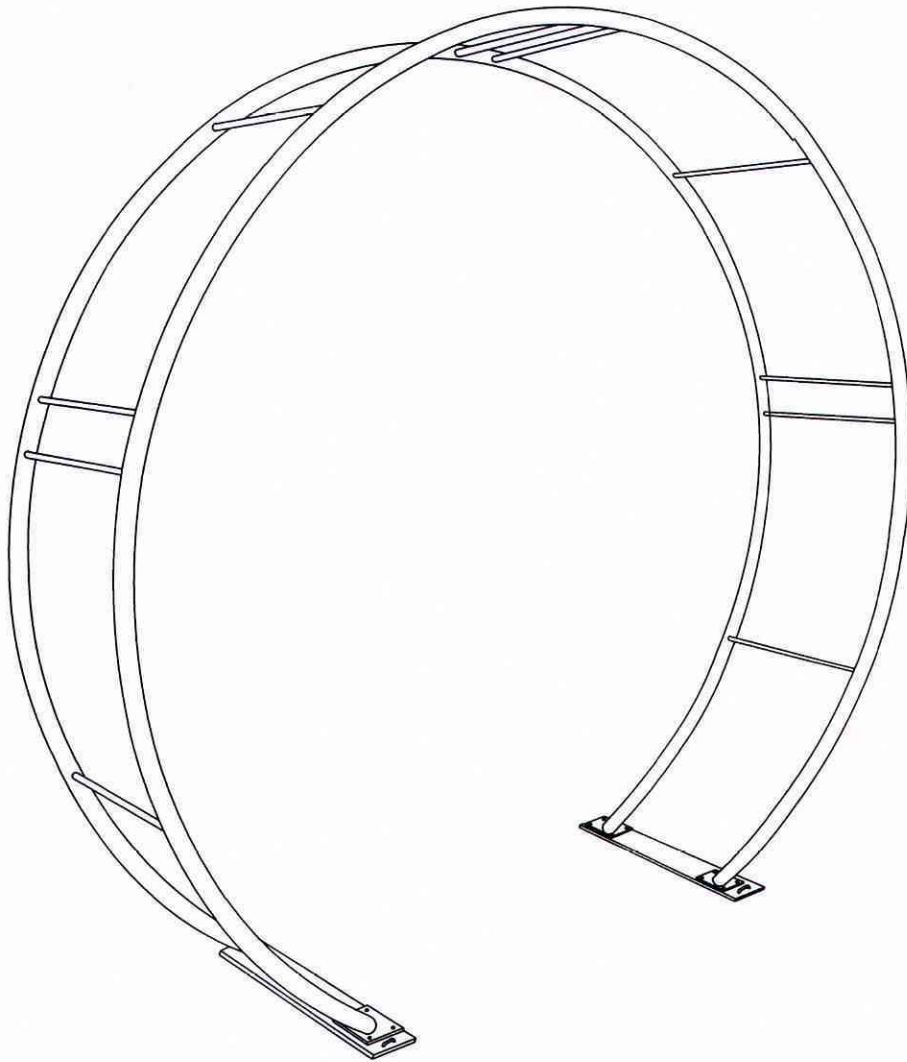

FIGURE - 4

ASSEMBLY & SET UP OF THE - MOON GATE



Now your Moon gate arch is complete