

Straightcurve® Rigid Raised Garden Bed Panel - 560mm

RL560WS WEATHERING STEEL | RL560GS GALVANISED STEEL

Product features

The details that make the difference

Wedge and slider join system for a faster, stronger no weld method



Full face visible instead of burying the edge. Discreet join seams for a stylish finish



Movable fixing spikes for easy obstacle avoidance

Continuous Fold Top and Foot for rigid straight lines

8mm rounded tops for child and pet safety

Universal bracing set with turnbuckle for fast, easier bracing

EDGE STYLE

FINISHES

- Galvanised Steel
- Weathering Steel

For Raised Garden Beds with straight edges

Product specifications

TECHNICAL SPECIFICATIONS

Length	2160mm
Top edge thickness	8mm
Steel plate thickness	2mm
Weight per length	22kg

BULK BUYING

Pack quantity	10
Bulk pack weight inc. pallet	236kg



SOLD AS SET INCLUDING

- Joining set includes 1 X join bracket (A), 3 x slider (B), 3 x wedge (C)
- 5 x Fixing spikes, galvanised, 300mm long
- 2 x bracing ribs (attached to panel/movable)

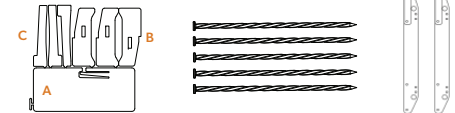

ADDITIONAL ACCESSORIES

REQUIRED

- D Universal bracing set (turnbuckle/chain/T-stake) - unless using 1100mm ground anchor set alternative

OPTIONAL

- E Corner piece (90° right angle / arm lengths: 255mm)
- F Reverse corner piece (270° L-shape / arm lengths: 255mm)
- G Ground anchor set - 1100mm (Tek screws required)
- H Join Part for Offcuts (Tek screws required)

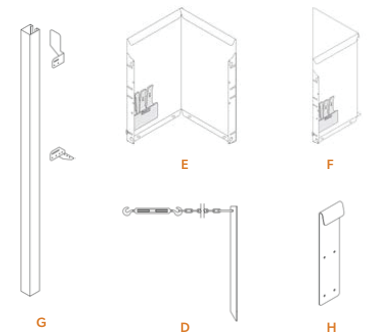

Rigid Raised Garden Bed Panel - 560mm Installation Guide

Scan or click to watch install video

▶ INSTALL GUIDE



REQUIRED FIXINGS

- Ground anchor set
6 x Tek Screws (12G x 16mm)
- Join part for offcuts
8 x Tek Screws (12G x 16mm/ zinc colour for WS)

RECOMMENDED TOOLS

- Ground leveling tools
- Metal hammer
- Rubber mallet
- Cordless drill and Tek screw bit (for accessories G and H)
- Angle grinder (required if modifying lengths or fashioning corners/ends)

PREPARATIONS

The Rigid Raised Garden Bed requires NO digging in as its feet are secured to the ground surface. The base should be smoothed/ leveled for the edge to sit flush on the ground during installation. Any obstructions should be removed or re-routed. It can be installed on all level ground types including concrete surfaces (where packers are used to sit edge off ground to allow drainage). It is useful to have some cardboard or board to place under joins when connecting with the panel face down on flat ground. Grass and debris likes to get caught in the tight seam!

DO...

- ⊙ Check the line with a string line as you add more panels.
- ⊙ If using a pre-made corner start from there and work back.
- ⊙ Score an intermittent line rather than one deep score line if making corners

DON'T...

- ⊙ Use for curved line designs, instead use Flex Raised Garden Bed
- ⊙ Forcibly bend if aiming for a mild curve of a radius exceeding 26m
- ⊙ Forget to stake or brace your edge once joined
- ⊙ Accelerate rust with acids or salts (but soapy water is ok!)

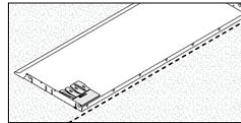

STEP 1 - Mark edge line on ground and layout edge pieces nearby.

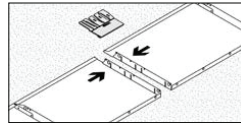

STEP 2 - Place first two edges front face down on the ground with ends touching and aligned.

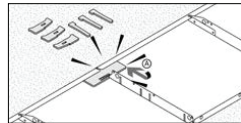

STEP 3 - Join using the joining set, break the pieces apart first by hand and insert join bracket (A) securely under the top lip (centred). Press it against back of panels (use a metal hammer to firmly lock in)

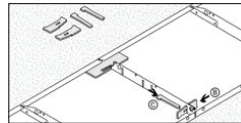

STEP 4 - Next, insert a slider (B) through adjacent bottom slots with its 'feet' against the edge. Knock it through fully so wedge (C) can insert and lock in the slider.

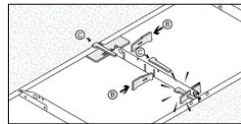

STEP 5 - Hammer the wedge in firmly. Repeat step 4 for middle and top slot using the remaining wedge and slider sets

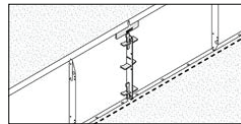

STEP 6 - Set these two edges upright and position where desired

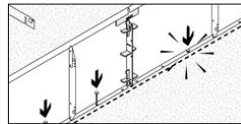

STEP 7 - Check the line, then hammer all fixing spikes (5 per length) through foot tab holes

CHOOSE YOUR BRACING METHOD

UNIVERSAL BRACING (TURNBUCKLE/CHAIN/STAKE)

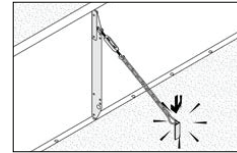

STEP 8A.1 - Using the universal bracing set, hammer in the anchoring stake and connect to bracing rib with chain and turnbuckle taut.

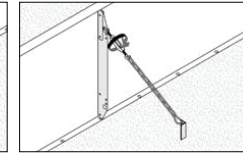

STEP 8A.2 - The turnbuckle is then used for fine vertical adjustment.

ANCHORING SET

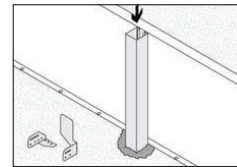

STEP 8B.1 - Alternatively brace with ground anchoring set-1100mm*. These posts are installed flush against back of edge

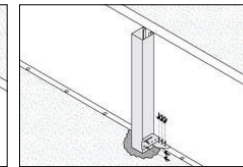

STEP 8B.2 - Once posts in position, screw the fitting set foot piece through guide holes to join the post and edge at the foot

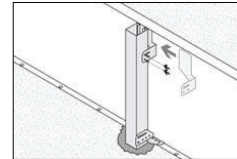

STEP 8B.3 - Fitting the top piece allows adjustment of the vertical, check carefully before final screwing to post

CONTINUE TO FINISH

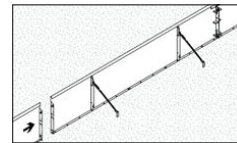

STEP 9 - Introduce further lengths (or joined pairs of lengths), butting them against the now standing edge and connecting them and bracing them as you go.

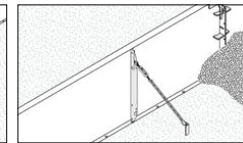

STEP 10 - Back fill your Raised Garden Bed to finish.

*The Ground Anchor Post may be screwed directly to the bracing rib (at guide holes) if not using the fitting set

Creating corners

PRE-MADE CORNERS

Pre-made corners with 255mm long arms are available for purchase and include the standard joining set. There is a standard 90 degree right angle corner and a reverse corner for turnbacks such as when making an L- shape. It's difficult, but the angle of these pre-made corners can be adjusted by applying considerable force using ratchet straps or other means.

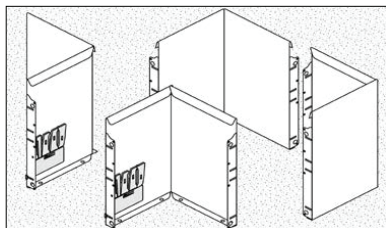

MAKING YOUR OWN CORNERS

To make a corner yourself you will need to use an angle grinder. Be sure to operate safely with all suitable gear.

1. Mark a vertical line down the back of the edge directly beneath a top edge notch space where the corner fold is needed. With the angle grinder score the line in three places sufficiently to create a fold line.
2. Also widen the top lip notch gap and cut and remove a bottom foot tab on one side of the fold line to allow room for bending in.
3. Bend strongly by hand; using a block of wood close to the fold to form the bend against helps.

For reverse corners (~270°) a fold line will need to be cut in as above. Also make a neat notch cutout in the back of the folded lip to aid the bend. No other cuts are required.

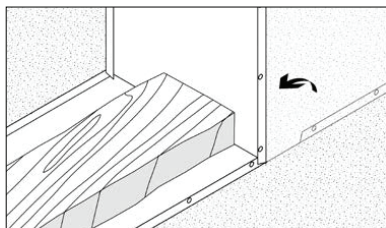
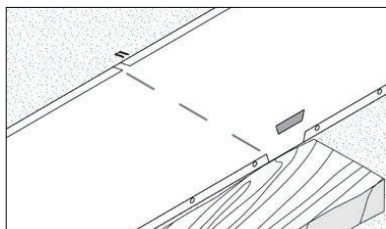

CURVE CAPABILITIES

In terms of curve capabilities, the 560mm Rigid Raised Garden Bed Panel barely curves. With care, you can achieve a 26m radius without distortion using this product.

Bracing methods

BRACING ON VARIOUS HARD SURFACES

The Universal Bracing Sets are best suited for these conditions. Simply fit the turnbuckle with chain to the pre-fitted bracing ribs and anchor back to the ground. Alternatively, the 1100mm ground anchor sets can be used on hard surfaces that allow a post hole.

1. The stake that comes with the Universal Bracing Set is of a star picket style and will penetrate very hard surfaces, as do the fixing spikes that lock in the feet.
2. On concrete, a bolt down method can be used in place of the stake, anchoring the chain with a DynaBolt™. Bolt the foot tab holes in place with an 8mm DynaBolt™, but first introduce packers to raise it slightly for drainage.

TIP: When using the Universal Bracing Sets, securing the anchor point to alternative structures such as walls or fences is also a workable solution.

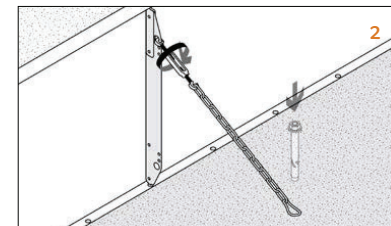
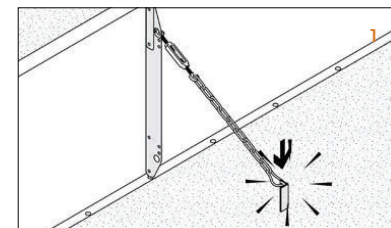

HOW TO MOVE A BRACING RIB

If bracing rib is located above an obstacle preventing staking at that position or where access is difficult it can be moved. Firstly, remove the bracing rib by knocking it laterally near the top with a hammer until loose. It can then be refitted in a new place, inserting the base portion into a bottom foot tab hole first, and then tapping the upper part of the bracing rib with a hammer to return it to a vertical position tight behind the top lip.

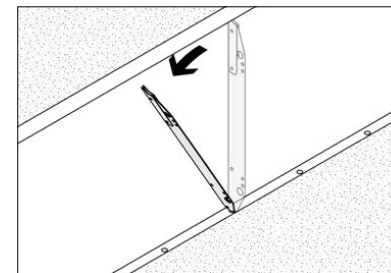

CREATING CONNECTION TABS OF YOUR OWN

The folded back flange on the end of a panel may be used to fix one end to a wall or other solid feature. Simply bolt or screw as appropriate to fix it strongly. When the edge panel is too long for this method you can use an angle grinder to make a fold back 'join tab' of your own. Remove the top lip portion, then create the fold back by the score and bend method. That tab can then be screwed internally to the surface it meets, which is sometimes another piece of Straightcurve®!

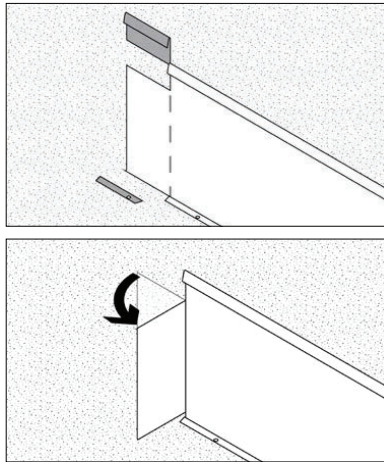

COMPATIBILITY AND WORKING ON SLOPES

1. The 560mm Rigid Raised Garden Bed Panel is compatible with the 560mm Flex Raised Garden Bed Panels. This allows them to work in combination. In fact, join slots align across all Rigid or Flex panels (240/400/560mm) so that a continuous top edge occurs if different heights are joined together.
2. This across height compatibility can be used to advantage with Raised Garden Beds on a slope. On the lower part of the slope the Raised Garden Bed run may need taller panels with a greater edge face visible due to the slope falling away, with panels of lesser height required further up the bank. It takes some careful planning, but can look very effective, adding volume and height to a bed while reducing the amount of steel used in the project overall.

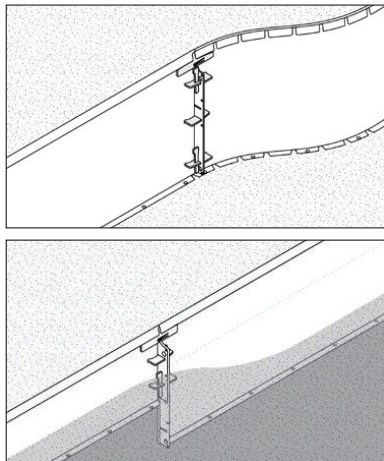

HOW TO USE A CUTBACK PANEL

If a length has been shortened with an angle grinder the join flange is then lost. To allow this piece to still be used the Join Part For Offcuts is simply screwed to the cutaway end (through guide holes in join part). This then overlays the length it is joining, and further screwing sees both panels neatly connected.

This overlay join part does mean screws are visible on the face of the Raised Garden Bed, but it is helpful with perimeters that require a part length to meet or when making regular shaped beds where the side length is predetermined. It also means no offcuts are wasted!

Some tips here are to either place the join part in the least conspicuous spot and use Zinc Screws which blend in as they rust over (for Weathering Steel), or make a feature of it by adding more join parts to create a pattern. With that approach, you may even choose to substitute polished bolt heads in place of the discreet screws.

