



**KMiata K24Z3 Swap Package Installation Guide**

**KMiata Inc.  
[www.kmiata.com](http://www.kmiata.com)**

**Published December 2019**

**Updated January 2020**

## **KMIATA INC. DISCLAIMER OF WARRANTIES FOR MOTORSPORT PARTS**

MOTORSPORTS, for the purposes of warranty, is classified as any automobile activity that takes place off of a public highway, or on a public highway in a competitive environment.

All KMiata products are guaranteed to be free of structural, material, or workmanship defects at the date of purchase. KMiata is not liable for any loss, damage, injury, or expense, either consequential or incidental, from the use of these products. KMiata assumes no responsibility for any losses, costs, or extra expenses as a result of a defective item or the return for warranty determination of said item.

No claim is made as to merchantability or condition of any KMiata products for any particular purpose. The entire risk as to the quality and performance of such parts is with the buyer. Examine your parts carefully upon receipt. Should you decide NOT to use them, return them immediately in an unused condition for a credit, less shipping costs and restocking fees. Should such parts prove defective following their purchase, it is of the sole discretion of Metric Performance to warranty these products within a period of 30 days if the parts are UNUSED.

Given the nature of parts used in competitive motorsports environments, KMiata offers NO WARRANTY for parts that have been installed on a vehicle. If the buyer feels that a manufacturing defect has been found prior to installation, KMiata should be contacted immediately.

### **MOTORSPORT PARTS ARE DESIGNED FOR OFF-HIGHWAY OR RACING USE ONLY.**

Because U.S., Canadian, state or provincial laws and regulations may prohibit removal or modification of components that were installed by the vehicle's manufacturer to meet emission requirements or to comply with motor vehicle safety regulations applicable to vehicles manufactured for use on public roads, Metric Performance recommends that vehicles equipped with Motorsports parts not be operated on public roads, and offers such parts only for track or off-highway competitive or performance use. Motorsports parts are intended for off-highway application only. Installation on a vehicle intended for use on public roads may violate U.S., Canadian, state or provincial laws and regulations including those relating to emission requirements and motor vehicle safety standards. In California certain parts may be used legally on a racing vehicle which will never be operated on public roads. In addition, installation of Motorsports parts may adversely affect the warranty coverage on your vehicle. Other local, state, provincial, territorial, or international laws may apply to the use of these parts. Please check your local laws before purchasing or using these parts.

### **RACING AND MOTORSPORTS IN GENERAL ARE A DANGEROUS SPORT. THIS INCLUDES BOTH PROFESSIONAL, AMATEUR AND DRIVERS EDUCATION EVENTS.**

Accidents and failures can occur at any time. Be aware that use of parts and services as well as participation in Motorsports activities carries a significant risk, and the Purchaser assumes all risks. KMiata is not liable for any damage to vehicles or other property due to the use of Motorsports products. Any parts from KMiata should be inspected regularly for any damage or wear.

## **K24Z3 Miata Swap Installation Guide**

Thank you for purchasing a K24Z3 Miata engine conversion package! We are sure you'll be as thrilled with this engine conversion as we are. Please note that this is an installation *guide* only, and does not necessarily offer complete step-by-step instructions for installation. Please read through the entire guide before proceeding.

KMiata recommends that this conversion be completed by a professional performance shop. KMiata assumes no liability for product that is installed incorrectly, or any resulting damage to your car, engine, or other parts due to improper installation. If you have questions on something not in the guide, please call or email us at [sales@kmiata.com](mailto:sales@kmiata.com) and we'd be happy to help any way we can.

NOTE: this installation guide has details and pictures from an NB Miata installation (1999-2005). While the conversion kit can be installed in any Miata 1990-2005, there will be some variation in wiring and fuel setups, depending on the year of the vehicle.

### **Preparing the Engine**

The K24Z3 engine can be prepped before anything needs to be removed from the Miata. This guide assumes a stock K24Z3 engine is being used from a 2009-2014 Acura TSX.

To install this engine in a Miata using our Ultimate Swap Package, you will need to do the following modifications:

- Relocate the oil filter on the block
- Remove stock oil pump and install a K20 Type S oil pump
- Install a K20 windage tray
- Install the KMiata oil pump adapter and pickup
- Install the KMiata oil pan
- Install a K20A/K24A style trigger wheel on the crank
- Install the custom K24Z3 timing chain cover
- Replace the exhaust cam trigger wheel with a K20A/K24A style wheel
- Install the KMiata rear water neck
- Install KMiata engine mounts and bushings

Thankfully, the K24Z3 already includes a 50 degree VTC gear on the intake cam, so upgrading this gear is not necessary as it was on our original K24A2 swap.

Note: some of these photos were taken with bare aluminum pre-production parts and old hardware. All production engine mount components are anodized hard coated black and include new zinc plated flange bolts. Here's the complete production mount kit:



To get started, put the engine on a stand and strip it down. Remove the manifolds, oil pan, VTC solenoid, and timing chain cover. The timing chain cover comes off by removing all of the 10mm head bolts and then prying it off to break the Hondabond seal. Set the engine at the top dead center (TDC) for cylinder 1 and remove the timing chain tensioner and timing chain.

Then flip the engine upside down and unbolt the stock oil pump with the balance shafts, and remove the oil pump chain, guide, and tensioner. Clean all the old Hondabond (RTV) off the mating surfaces of the pan and chain cover. The block should look like this:



If you plan on re-using the tensioner, put a pin here before removing it from the block:



Next, locate the oil filter mount and unbolt it from the block:





Also unblolt this cap:



Neither of these pieces will be used for the swap.



Your K20 oil pump upgrade kit from KMiata, specifically for the K24Z3, includes this threaded plug that allows you to install the oil filter in the older K series filter location on the side of the block. The Honda part number is 90015-PH1-013:



Your KMiata engine mount kit includes an oil filter mount block off and new OEM O-rings:





It installs like this with both O-rings behind it (again, pre-production bare part in this photo):



Next, flip the block upside down to prepare to install the oil pump pieces. First, locate this oil jet:



It NEEDS to be removed and plugged when installing a K20 pump. This is very important. You can either use a small drill bit to catch in the inside of the plug, or a small machine screw. Once it catches you can use pliers to pull it out.



Your KMiata oil pump kit includes a short M8x1.25 bolt that needs to be threaded in to plug this hole. We also recommend putting a bit of Hondabond around the threads to ensure a perfect seal:



Next, you're going to install the small aluminum bracket that adapts the K20 pump to the K24Z3 block. These components are also included in the K24Z3 spec K20 oil pump upgrade kit:



It's needed to support the leg that extends off the K20 pump:



The long M8x1.25 bolts should be torques to 16 lb/ft.

Once the aluminum bracket is in place, the oil pump can be prepped and installed.

Unbolt the two halves of the stock K20 oil pump. Note that the outer gear isn't present in this picture but absolutely needs to be retained inside the pump:



Our KMiata oil pump adapter replaces the stock pickup and provides the necessary pickup routing to clear your Miata steering rack:



Lock the two pieces together like this and re-install the small 10mm head bolts:

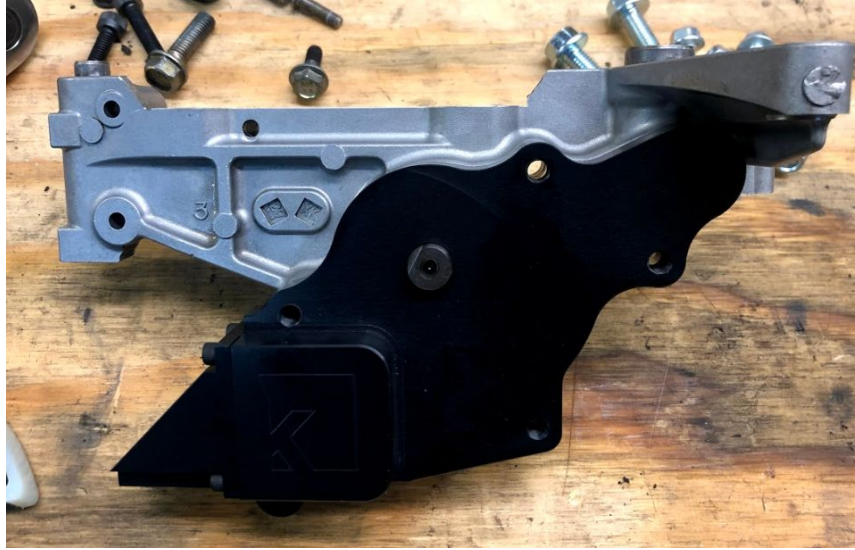

With the pump upside down in your hand, install the K20 oil pump chain (the K24 chain will not work) and hang the timing chain gear from it. Slide the gear over the crankshaft as you install the pump and line up the dowels:

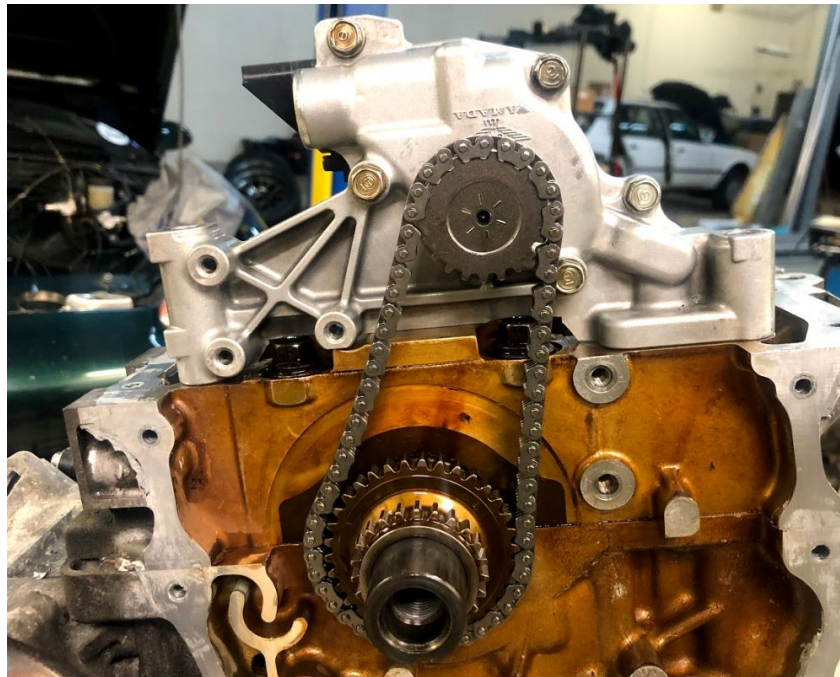

Use the supplied hardware to secure the pump but don't fully tighten the bolts yet.

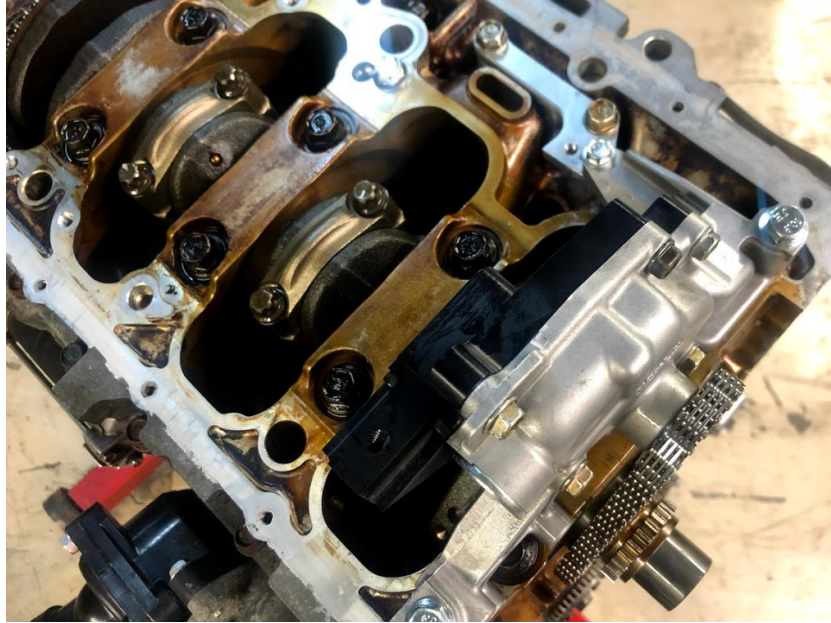

Next, the modified windage tray (also included in the K24Z3 oil pump kit) can be installed. The welded rails on the sides of the tray not only provide the correct mounting points to secure the tray, but also provide enough clearance for the larger K24Z3 rods that will hit the tray otherwise.



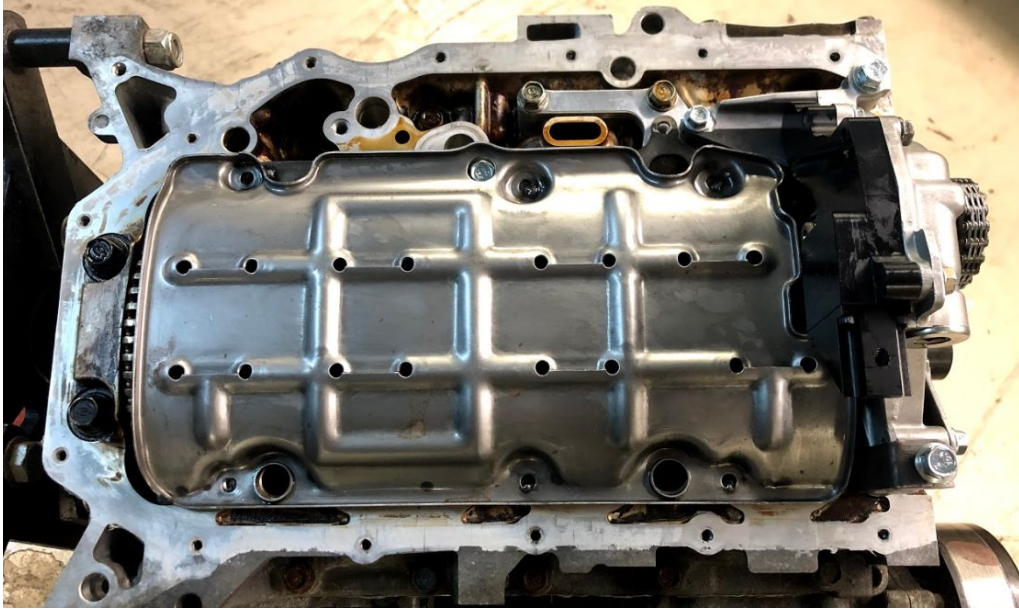

The pickup tube should be installed next, and then all bolts on the tray and pump can be tightened. Make sure the O-ring is present that goes between the pickup tube and oil pump adapter.

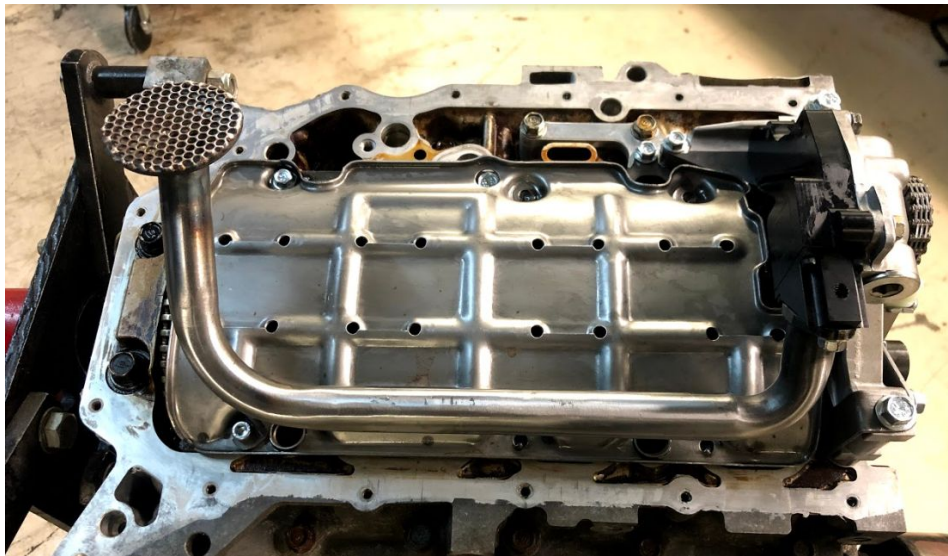

**Once everything is tightened down, spin the crankshaft by hand to make sure that the connecting rods are not interfering with the tray or rails. If there is any interference, it's better to address it now before the oil pan is sealed up.**

Once everything is secured, the K20 oil pump chain tensioner and guide can be installed like this:



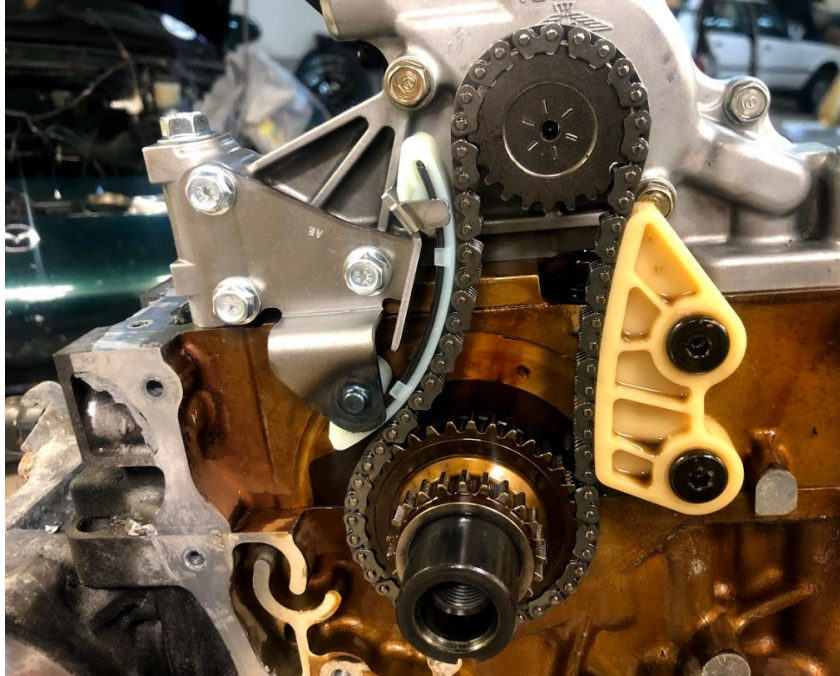

Next, the timing chain, guide, and tensioner can be re-installed. On the cam gears, you'll notice marks on the inside and tops of the gears that confirm that the cams are at top dead center (TDC). You will also see two sets of gold links on the chain. These links need to be placed on the gears with the dot on the gear between the gold links:

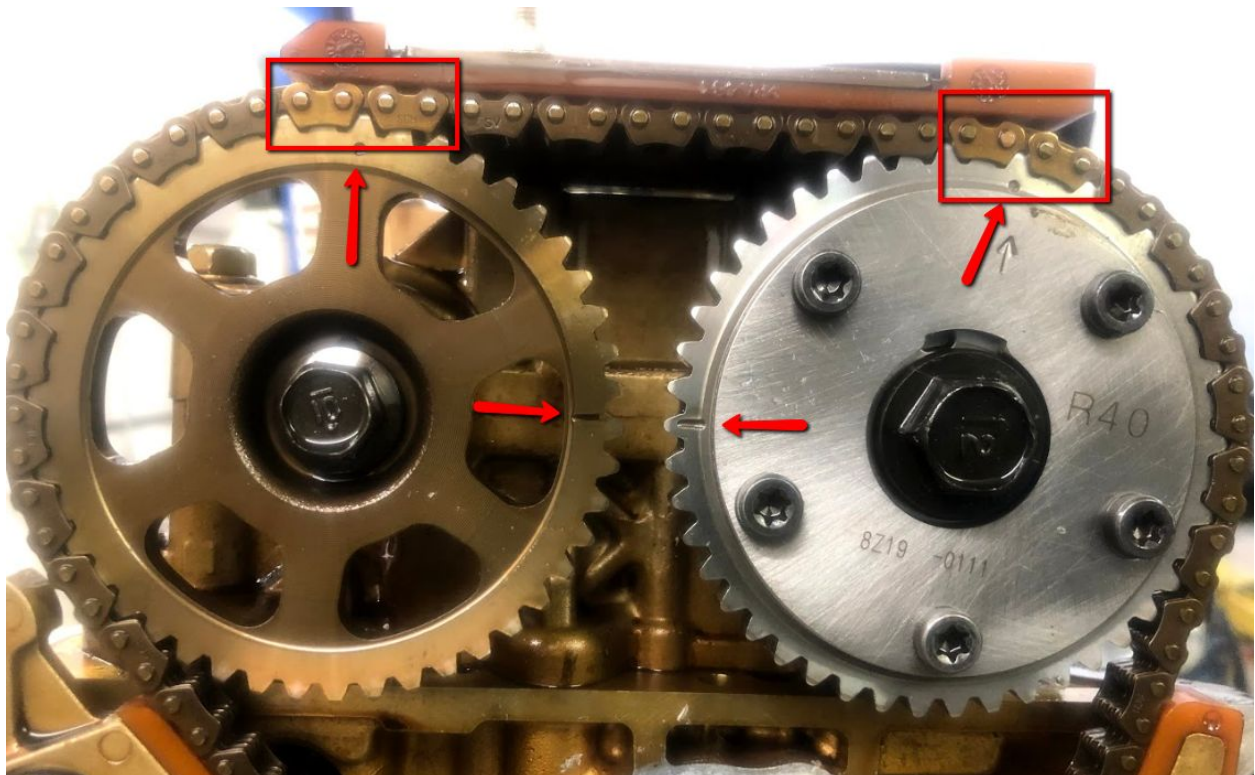

On the crank, make sure the gear is positioned at TDC and lined up with the arrow on the block here:

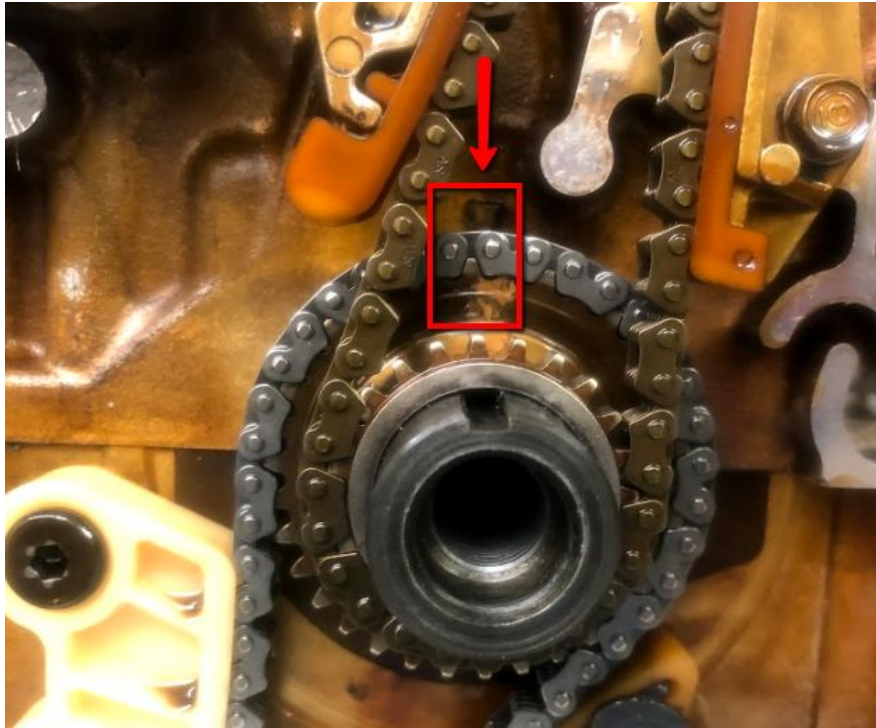

It can't be seen in this photo, but there is also a single gold link that corresponds to a mark on the bottom left side.

An extra set of hands can be useful at this point. Hold the chain in place like this while the left guide and tensioner are installed:

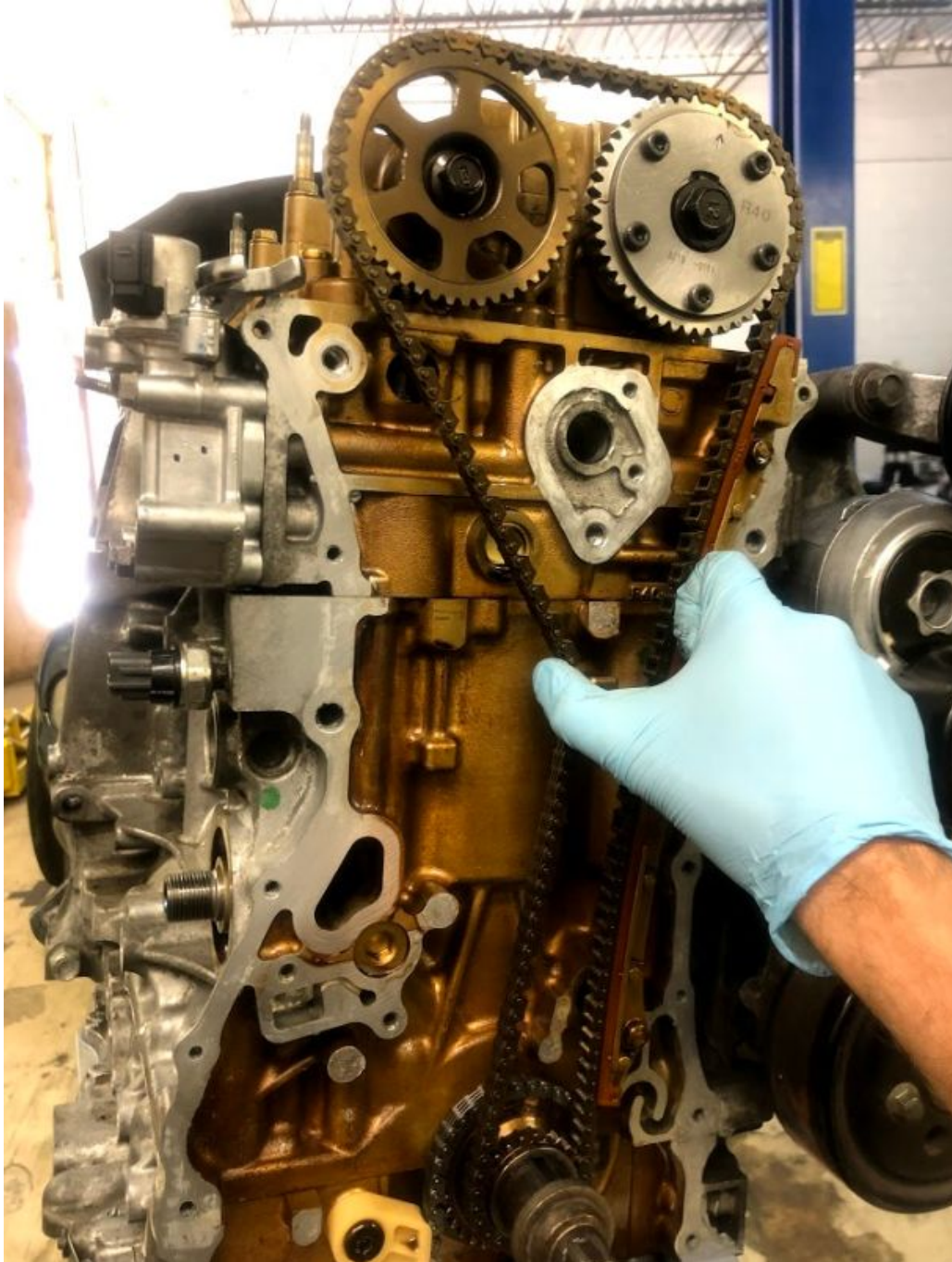

Once complete, the pin can be pulled out of the tensioner to lock everything in place. Use the crank pulley bolt and a 19mm wrench to spin the engine clockwise once or twice to make sure everything is turning smoothly.

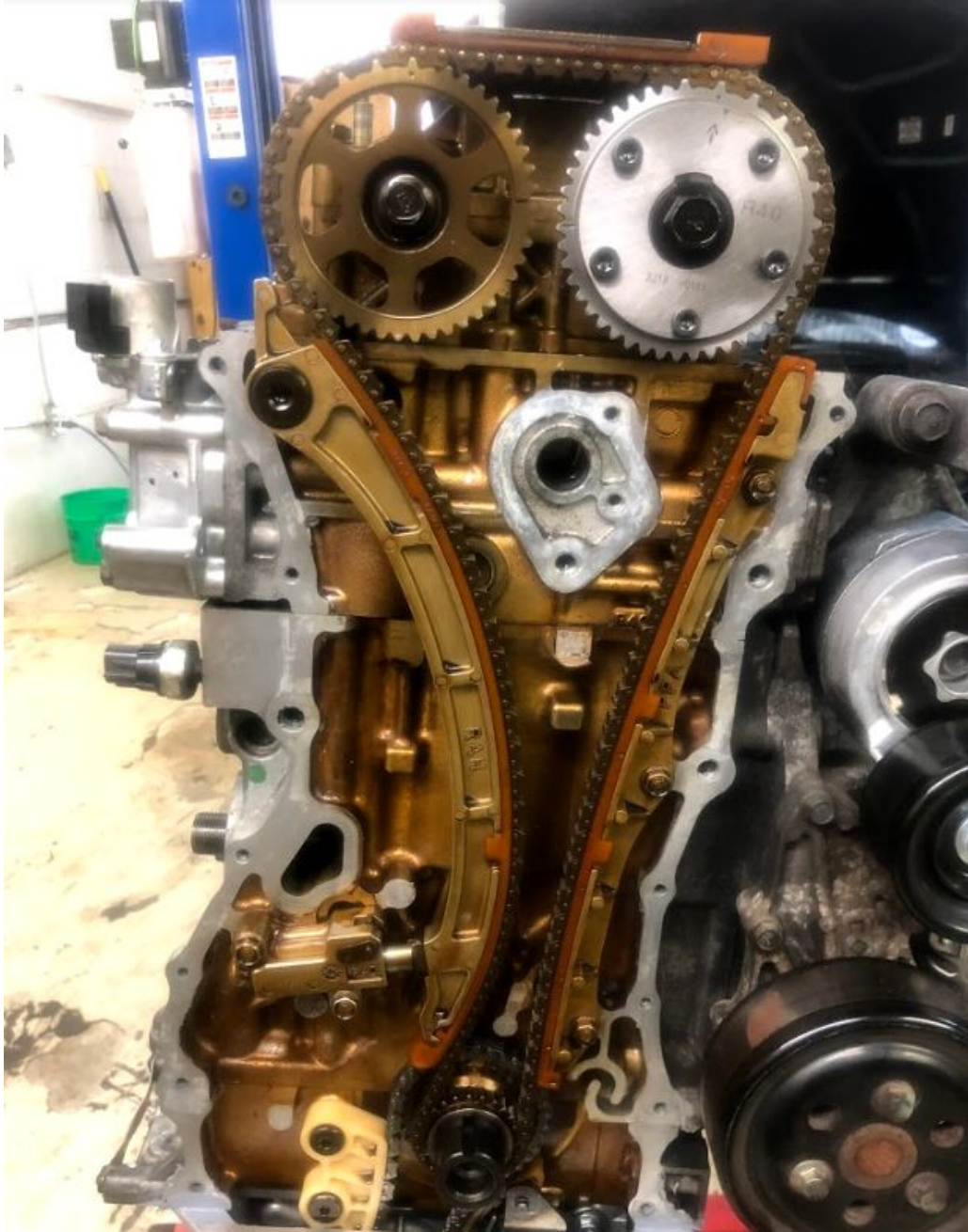

The rear water neck can also be removed from the engine:



It needs to be replaced with the KMiata water neck. Reuse the K series engine coolant temp (ECT) sensor and thread it into the new water neck. The second port in the water neck is for the factory Miata temp sender to operate the stock coolant temp gauge:



Street cars can use the 5/8" barbed fitting to retain heat and race cars can use the supplied 1/2" NPT plug to delete it. Be sure to use the supplied replacement OEM gasket as well.

The KMiata oil pan can also be installed at this time.

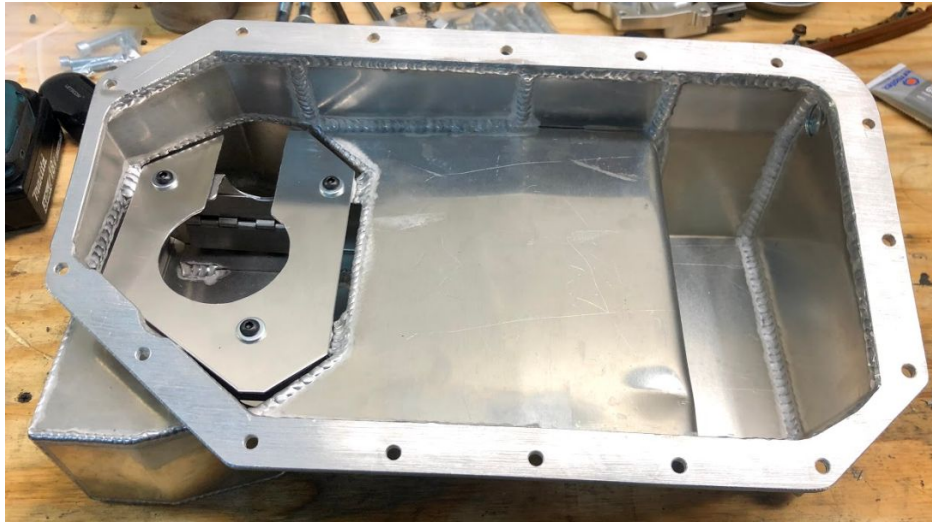

Carefully apply a bead of Hondabond directly to the bottom of the block *inside* the bolt holes for the oil pan.

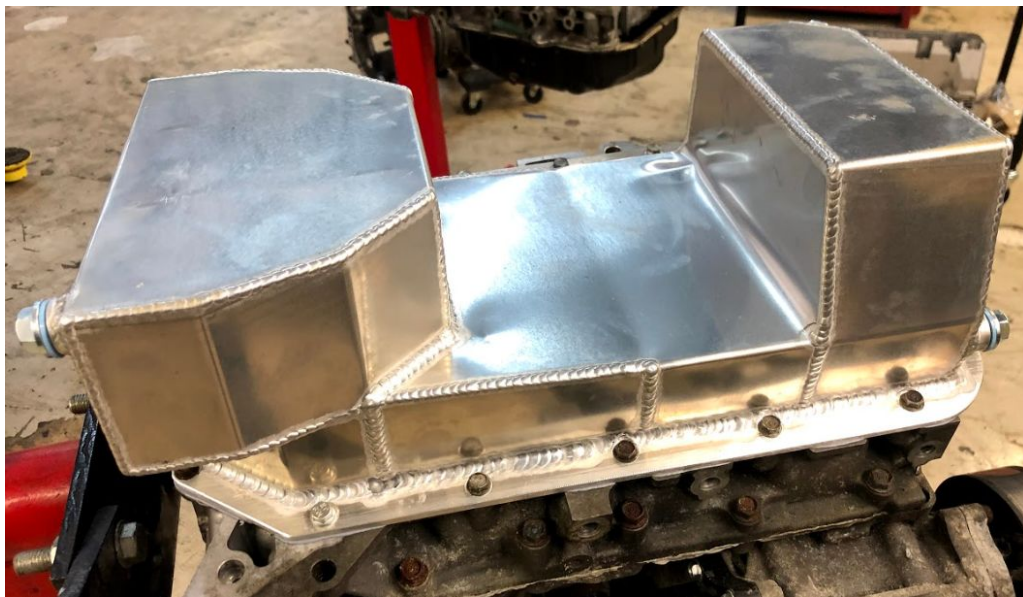

The final steps will vary depending on the type of crank sensor being used. Customers using our K24Z3 Race Kit with a standalone engine management system will simply install the stock timing chain cover back onto the engine and use the crank position sensor on the lower rear right side of the block. Customer using our K24Z3 Ultimate Swap Package with Hondata Kpro or KTuner will be using our custom timing chain cover that accepts the older K20A and K24A style crank sensor and pulse plate. This cover and older sensor is REQUIRED if you will be running a Honda ECU. The older Honda ECUs are not compatible with the K24Z3 crank trigger wheel, which is a large reason that these engines have been ignored by the swap

community in the past.

To convert to the old style crank sensor and electronics, you will need the following Acura part numbers. They are inexpensive and very easy to source used since they came on many thousands of Honda and Acura engines from 2002-2008:

- Crankshaft pulse plate: **13622-PNA-003**
- Exhaust camshaft pulse plate: **14114-PNA-003**
- Crankshaft position sensor: **37500-PNB-003** (K20 style for Kpro) or **37500-RAA-A01** (K24 style for KTuner)

In order to make the older sensor work on this engine, the spacer (left) needs to be replaced with a K20A or K24A pulse plate (right):



For extra clarification, this is the spacer installed:



This is the pulse plate installed:

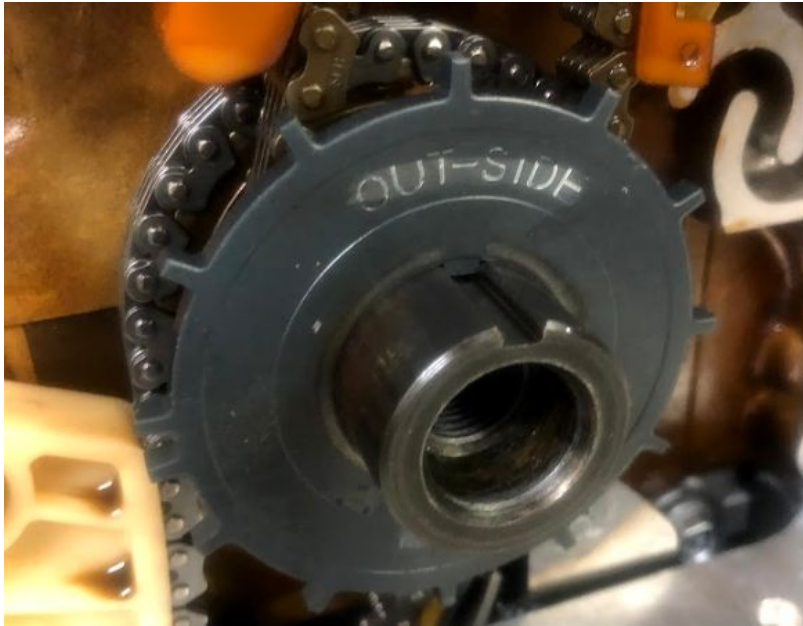

And yes, the word “outside” needs to be on the outside.

The exhaust cam pulse plate also needs to be replaced to work with the older style ECU. Just unbolt the stock one and install the one listed above.

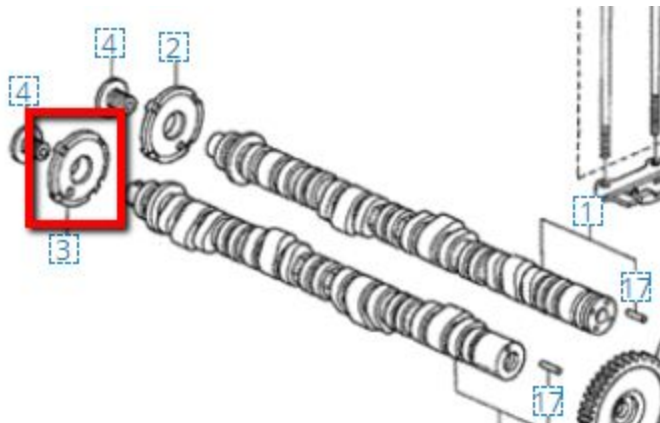

Once all this is done, the timing chain cover can be reinstalled. Our billet timing chain cover is pictured here, which is being supplied with all early K24Z3 Ultimate Swap packages. Due to the cost and complexity to machine these pieces, a cast version of this cover will be standard sometime in 2020.

It installs just like stock, except in two pieces (the cast version will be one piece). Hondabond should be applied to the back and bottom of the cover in the exact same places that the old



Hondabond was scraped off:



Note that the two lower corner bolts are the special bolts with the built in dowels:



The valve cover can now be reinstalled, ideally with a new gasket and spark plug tube seals. We also suggest trimming the dipstick, as it will hit the top of the oil pan “tunnel” above the steering rack. Try installing it and measure how much needs to be cut off. Once trimmed, we suggest adding 6 quarts of oil to the pan and then using a punch to mark the full line on the dipstick.

Engine mounts can also be installed at this time. Again, these photos show pre-production bare aluminum mounts and old hardware. The right mount bracket is installed here. Note that the area marked below will need to be ground down in order for the mount backing plate to fit.

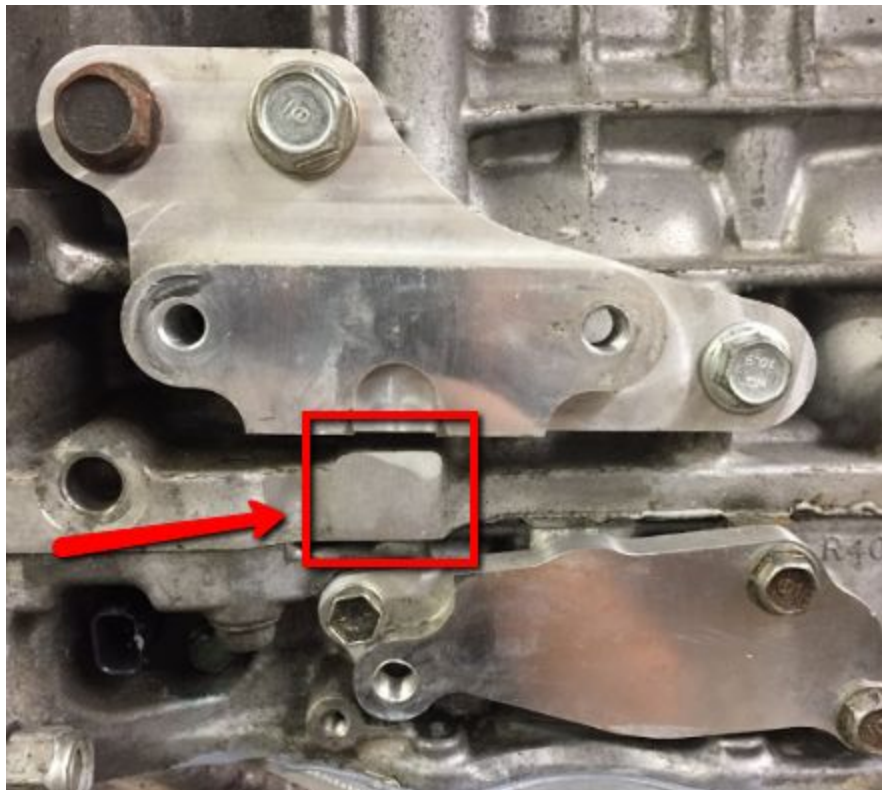

The Energy Suspension poly mount is installed on top of the bracket and oil filter block off, and it MUST be installed with the single backing plate that's supplied with your kit.



The left mount (driver side) bolts in place here, underneath the starter. First bolt the machined bracket to the block, and then bolt the Energy Suspension poly mount to it. Note that a backing plate is not needed on this since since the full surface area of the plate is machined into the mount bracket.



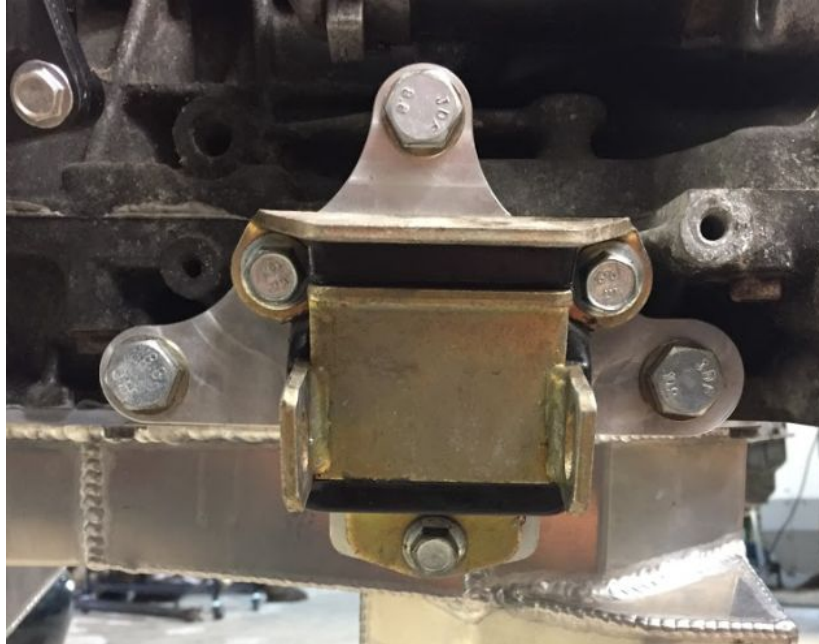

If replacement mounts are ever needed, use Energy Suspension part 3.1114G. One is needed per side.

If you're retaining heat, the black heater hose pipe can be cut here:



Alternatively, it can be replaced with our new barbed thermostat heater hose adapter, coming soon.

The adapter plate and flywheel can be bolted to the engine at this time. Use Acura part number **90011-RDB-000** for the flywheel bolts, available on our website or through any Acura dealer.



Note: If you are using an engine from a manual transmission donor car (rare), the engine dowel pins will be too long to fit inside the adapter plate. PLEASE do not just remove them, they are important to retain proper adapter plate fitment. You will need to replace them with the shorter 15mm dowel pins from an automatic car, Honda part **90701-PW5-000** (quantity 2).

### **Removing Factory Parts and Preparing the Vehicle**

Now that the engine is fully prepped, the Miata chassis is ready to be disassembled and the stock engine removed.

You need to remove the factory engine, transmission, and all engine accessories, as well as the dashboard, heater core, and blower motor. Before you do any of this, please disconnect the negative battery cable.

Since you'll be retaining the stock subframe with this swap, we recommend pulling the engine and transmission out from the top as one unit. Remove the radiator and also the shifter from the back of the transmission to create the necessary clearance needed.



All of the emissions-related components on the passenger side of the vehicle can be removed, as well as the vent line that runs from the charcoal canister back to the fuel tank (some customers may prefer to retain this). The only part that needs to remain is the larger fuel hard line. Please note that an NA Miata will need to retain the return fuel line as well.

Our original K24A2 swap package required all NA Miata owners to switch to an NB steering rack. Since the stock subframe is retained with the K24Z3 swap, the NA rack can now be retained.

We recommend doing a full depowering of the rack, including complete disassembly, cleaning, greasing the inside, and also the power steering inlets along the rack body need to be cut off and either welded or taped shut. Welding the pinion is ideal if you have the means. Plenty of information on properly depowering a Miata steering rack can be found online. We can also connect you to someone that performs this service. If you'd like it done for you just send us an email.

This is a great time to thoroughly clean the engine bay and subframe, and remove all unwanted clutter from the factory engine bay.

### **Preparing and Installing the Transmission**

Our K24Z3 swap uses the same K series to Miata adapter plate and flywheel that our original swap uses. This flywheel is designed to work with any 1.8L Miata clutch kit. We prefer the ACT HD organic clutch that we carry on our site, but any 1.8L style clutch can be used. It installs on our flywheel just like it would on a stock Miata.





In order for the Miata transmission to work with the K Miata adapter plate, it has to be modified slightly. The trans bellhousing needs to be notched since the K series starter is used. The Miata starter is on the passenger side of the vehicle, while the K series starter is on the driver side. The K starter needs to protrude 0.75" into the trans bellhousing. The simplest way to do this is to mock up the adapter plate on the transmission and use a permanent marker to trace where the cutout needs to be.

We used to do this modification with a reciprocating saw, but now we prefer to use a 2" hole saw for a clean, round cut. Here's a shot of the final profile. (Of course the clutch lines are in this shot temporarily and do not normally go through the starter hole).





In order to provide 3 inch exhaust clearance on the right side of the transmission, our K24Z3 swap uses a custom hydraulic release bearing. This permits the factory Miata slave cylinder and clutch release fork to be deleted and allows us the space we need for exhaust routing.

The hydraulic release bearing also needs to be paired with the supplied Wilwood 3/4" master cylinder kit.

The 5-speed release bearing is on the left and the 6-speed is on the right. They are not interchangeable, which is why you were required to specify the transmission you're using at checkout.



Installation is straightforward. Remove the factory release bearing, release fork, and guide tube assembly. Drill two ½" holes in the side of the bellhousing for the clutch line and the bleed line.

The 5-speed kit includes a new Mazda gasket that needs to be installed behind the housing and the 6-speed uses RTV instead of a gasket.

Some transmissions include a shim behind the stock housing, which should be retained. There are a number of replacement shim thicknesses available from Mazda for these transmissions, so if your current shim is not fitting well with the new housing, you may need to source a different thickness from your local Mazda dealer.

A new Mazda seal is also included, which needs to be pressed into the rear of the new housing just like the stock piece you removed.

The -3 AN fittings are pre-installed in your housing and marked with a paint marker. We supply you with new outer bolts, which we recommend using a bit of red Loctite on before final assembly. Make sure your -3 AN fittings are fully tightened, as a leak down the road will involve removing the transmission. The 3 foot banjo line supplied in the master cylinder box will be used as your clutch line, and the shorter line with the remote bleeder can be mounted outside the bellhousing anywhere you would like. You'll use it to bleed the clutch system so positioning it in a convenient location is ideal.

It's also a good idea to cover up the clutch release fork opening with a piece of thin sheet metal to keep out debris. This can also be a handy access opening for any future clutch diagnosis.

Once the bearing and lines are installed, the transmission can be bolted up to the adapter plate for the final time and the entire drivetrain can be shoehorned into the engine bay.

Don't force the transmission input shaft in. With a little finesse, you'll be able to line it up and it should slide in smoothly.

Make sure that you use the proper length bolts in each hole for the adapter plate. This can be done by lining the bolts up alongside the trans to be sure that a bolt won't be mixed up and extend past the adapter plate. We recommend keeping the alternator, starter, and intake manifold off the engine until it is secured in the vehicle. This will make it much easier to install the driver side engine mount and complete the necessary wiring.

Use the 90mm bolts and lock washers we supplied in the engine mount kit to secure the engine to the subframe mounting blocks in the factory engine mount location.





Note that on most NA Miatas and the occasional NB, the rear “shelf” in the engine may need to be trimmed by  $\frac{1}{2}$ ” or so, otherwise the adapter plate will hit it:



The Wilwood clutch master cylinder upgrade can be installed at this time too. Remove the Miata master cylinder and hard clutch line that crosses over to the passenger side of the vehicle. Both can be discarded.

Once the factory master cylinder is removed, mock up the supplied steel adapter against the firewall. You'll notice that some material on the firewall will need to be cut to fit the master fully into the opening. Use a Sharpie to mark the area that needs to be opened up, and use a Dremel

or small cutting tool to shave away the excess metal. Once this is done, the adapter and master can be bolted into place, and the clevis can be attached to the clutch pedal under the dash.



Take care to set the pedal height so there is a small amount of play before the pedal begins to push the master cylinder pin. If it is set too tightly, your clutch will not fully engage and it will overheat and slip.

Note: a small number of customers have reported to us that the pushrod on the Wilwood master cylinder has been too long for their application, resulting in the clutch pedal remaining slightly depressed even when adjusted in fully. If this is the case with your car, the pin can be cut slightly to allow the rod to be shortened a 1/4". A small amount of free play should be present when this is installed correctly.

### **Engine Accessories**

Thanks to our new KMiata intake manifold and the unique throttle body positioning, the factory K24 auto belt tensioner, idler pulley, and alternator now fit in the factory configuration. If you're running a car with no air conditioning and the stock K24 crank pulley, use the supplied belt (7PK1360) and install it like stock. Just use a 14mm wrench to pull back the tensioner to slip it over the pulleys.



Any K series starter will work with this swap, although a starter that came from the same donor as your engine harness will make it a bit cleaner. You must use a 2009-2014 Acura TSX alternator, the older style K24 alternators do not fit on the K24Z3 water pump housing.

We recommend only mocking up the intake manifold on the engine for now. It's easiest to torque it down once the charge harness wiring has been completed.

### **ECU and Engine Management**

At the time of this publishing, KMiata supports two wiring configurations for this swap. Some customers may opt to use a full standalone (Haltech, ECU Master, etc), in which case our K24Z3 Race Kit should be used and the wiring harness would need to be custom built.

Our two supported combinations of ECUs and harnesses are as follows:

- 1) Hondata Kpro4 engine management, installed in a 2002-2004 RSX (PRB or PND) ECU. The ECU can be sourced from any 2002-2004 Acura RSX (base or Type S, manual or auto). The engine wiring harness and charge harness must also be sourced from the same vehicle. Auto and manual transmission harnesses can both be used, although the manual harness will have fewer extra transmission connectors to delete.
- 2) KTUNER engine management, installed in a 2003-2005 Accord automatic (RAD) ECU. A 2003-2006 Honda Element engine harness and charge harness must be used with this combination, either auto or manual. choosing to use other ECUs or products.

Other ECU combinations may work with this swap, but in an effort to provide the most clear

information to our customers, KMiata does NOT provide wiring or ECU support to customers

NOTE: If you're using Kpro and an RSX harness, you'll want a K20 style crank position sensor found on these vehicles. If you are using KTuner and the Element harness you can use any K24 style sensor.

### **Preparing Your Engine Wiring Harness**

As you will notice, the RSX and Element have many sensor connectors that are similar to the K24Z3 connectors, but not the same and thus not interchangeable. Because of this, one of the following needs to take place:

- Connectors from a K24Z3 harness need to be removed and de-pinned and/or spliced onto the RSX/Element harness
- A connector pack with all necessary connectors can be inexpensively purchased
- A complete custom wiring harness for this application can be used.

The second two options are in the works from KMiata and will be available early 2020.

We also recommend removing all of the factory plastic housings off the K series engine harnesses. We recommend adding some split loom and high quality vinyl electrical tape in certain areas to clean up your work.

The following is a breakdown of the differences between the RSX and Element harnesses and the sensors on the K24Z3, along with the easiest solution to adapting your K24Z3 sensors to the older harness. All of the necessary connectors will be available from KMiata shortly, or can also be pulled off any junk K24Z3 harness. We'll also be adding pictures of each sensor soon.

### **Injectors**

The K24Z3 injectors use a different style connector and also a different pin. Our intake manifold supplied with the swap package has also been machined to accept the larger body K24Z3 injectors.

Because of this, it's best to splice a new set of injector pigtails onto the older harness so you can use the factory K24Z3 injectors.

### **Ignition coils**

The coils on the K24Z3 are the same size as the older K24 coils, but the connectors and pins are different. Because of this, our recommendation is to just run the older style coil. They are inexpensive used, and there are plenty of inexpensive new aftermarket options as well, such as the Delphi coils.

## **Alternator**

The alternator connector and pins are different, so we recommend splicing on a K24Z3 style connector. The wire colors between the two connectors match, making this very easy.

## **Cam angle sensors**

The K24Z3 cam angle sensor connectors are nearly identical to the older connectors. The pins inside the connectors are identical as well. Because of this, we recommend de-pinning the connector and swapping a K24Z3 style one onto the older harness, without changing the pins.

Alternatively, old style cam angle sensors can be used. Lastly, the guides on the sides of the sensors can also be cut off with a knife so that the new connectors fit on the old sensors without any connector or sensor swapping.

## **Crank sensor**

No change is needed to this connector. Just install the correct sensor in the KMiata timing chain cover and you're good to go.

## **VTEC solenoid**

The VTEC solenoid connector located on the exhaust side of the cylinder head is different but the pins are the same, so a new style connector can be pinned right into the older harness. Alternatively, a pigtail from a K24Z3 harness could also be spliced on.

## **VTEC pressure switch**

We typically don't run the VTEC pressure switch on our cars. JDM engine harnesses don't even include this connector. So we recommend just not connecting it and disabling the VTEC pressure switch in Kpro.

## **VTC solenoid**

The VTC solenoid on the top center of the timing chain cover uses a slightly different connector with the guides on the side of the sensor in a slightly different position, but the pins are the same. You can either swap the connector, swap the solenoid, or just trim the guides off the solenoid.

## **Manifold Air Pressure (MAP) sensor**

This sensor, which is installed in the KMiata intake manifold, uses the exact same connector as



the cam angle sensors. If your used engine didn't come with a MAP, just order one from an RSX. Otherwise you can swap the connectors, shave down the guides, or swap sensors.

The connector wires for the MAP will also need to be lengthened a bit, or alternatively you can use our MAP extension harness for this to avoid cutting.

### **Throttle Position Sensor (TPS)**

The K24Z3 doesn't use a TPS from the factory, since a drive by wire throttle body was originally supplied on these engines. Because of this, you'll be adding a TPS to your 74mm throttle body we have supplied.

The original K20 sensors are not available separately from Acura and are also prone to failures, so we use a B series style throttle body in our kits, which accepts a TPS from any B/H/F/D series Honda. We recommend one of the following:

- 1) A used OEM B series style TPS. The easiest cars to find these from would be a 1992-2000 Civic or 1994-2001 Integra.
- 2) The ACUITY Hall Effect K series TPS. This is the only aftermarket TPS worth using. We started testing this in 2019 with very good results. You'll need to pair it with a B to K TPS adapter, Skunk2 part 309-05-0100.

Of course, you'll need to use the corresponding connector for either the K or B sensor.

NOTE: the TPS and MAP use the exact same connectors, and if you switch them your car will not run and you will potentially damage the sensors. The TPS connector has a RED signal wire in the center.

### **Engine coolant temperature (ECT)**

This sensor threads into the KMiata upper water neck on the back of the head. Once again, the plastic guides on the sensor are different between the two engines. If you don't have a sensor, just order the RSX version for \$10. Otherwise the connector can be swapped or the guides trimmed.

### **Knock sensor**

The knock sensors are the same between the two engines, so no change is needed

### **Primary (wideband) oxygen sensor**

You'll need to use a primary O2 sensor that corresponds to the harness you are using. They all look the same externally, but are different. We like the Denso sensors from Rockauto.com. Just

be sure it's from a 02-04 RSX or 03-06 Element, depending on your harness choice listed from the options above.

For Kpro, we use Denso part #234-9005, and for KTuner we use #234-9064.

### **Idle air control valve (IACV)**

Gain, since the K24Z3 was originally paired with a drive by wire throttle body, you'll need to add an IACV to retain stock idle functionality. Alternatively, the IACV provision on the bottom of the intake manifold can be blocked off and the IACV can be disabled in Kpro.

If you are running an IACV (recommended) then you will need one from a 2003-2005 Accord or 2003-2006 Element, Honda part number 16022-RAA-A01. An OEM one is best (new or used), or any of the green aftermarket units. Avoid the cheap silver \$20 Chinese parts, they don't hold up very well.

### **Wiring the Vehicle**

NOTE: KMiata is not responsible for any damage to your vehicle based on these wiring guidelines. Please do your own homework and check the Miata schematics for your exact year vehicle. Note that the general Haynes manual for these cars has many wiring discrepancies and overgeneralizations. In order to minimize frustrations on your end, and also phone calls to us for wiring diagnosis questions, please use the diagrams from your specific vehicle.

This is simply a guide on how our 1999-2000 test car is wired. Check every connection with a multimeter before starting the car. If you do not know what you are doing, do NOT attempt to wire the car.

### **Starter and Alternator Harness Wiring**

There are at least two different ways to wire the starter and alternator. Big picture, you are simply taking the factory Miata starter power wire, and the Miata alternator wire, and extending them to the K24 starter and alternator. The OEM K series starter/charge harness has both of these large gauge wires inside it, as well as the starter solenoid, the alternator plug, and the knock sensor.

Our preferred way is to separate out the power wires from the charge harness so they can be removed separately if needed. We like to cut off the Miata starter and alternator eyelets and then use butt splice connectors to extend the factory Miata power wires using the K series wires, like this:



The black starter signal wire in our conversion harness has a “to starter relay” wire that allows you to use the factory K series routing. However, you can also just extend the Miata starter relay wire directly to the K series starter like we did in this picture and bypass the Honda harness and connector altogether.

Long story short, you’re not changing these circuits, you’re just extending wires as needed to reach the K series accessories.

The K series alternator and knock sensor portion of the charge harness can still be plugged directly into the K series engine harness and then run directly to the alternator and knock sensor. Remember to wrap up any loose wires in split loom to keep them protected.

If you choose to retain the OEM K series charge harness, you’ll want to cut off the battery and fuse box terminals like this:



In this picture, the top arrow shows the alternator terminal, and the bottom arrow shows the starter terminal.



The green alternator connector is what needs to get replaced with a K24Z3 alternator connector.

### **Under-Dash Wiring**

Your next step is to free up space inside the cabin. The dash should already be removed, but you also want to temporarily remove the heater core, blower motor, and A/C evaporator to provide more space to work. NB Miata owners should have the factory engine harness

unplugged, but NA Miata owners will find that the engine harness is integrated into the dash harness. Eventually, all unused wires can be removed, which will delete the engine side of the wiring harness. Each wire should be terminated properly with heat shrink wrap.

Once this is done, feed the K series harness through the firewall through the same hole as the factory harness, and then begin snapping all the connectors on to the engine.

You'll also want to remove a couple items off of your Miata harness to reuse. Carefully cut the firewall grommet down the side with an Xacto knife, and also snip off the connector for the Miata coolant temperature sender. You'll be re-using this connector along with the sensor off of your engine, which installs into the KMiata upper water neck in the 12x1.5 port. Once you're done with the wiring, you can wrap the grommet around the K series engine harness for a finished look.



At this point, nearly all wiring should be neatly in place in the engine bay.

Now you can plug in your K series ECU under the dash. We usually put the ECU in the passenger side footwell or on the transmission tunnel.

Now you'll be using the supplied wiring conversion harness to adapt the K series engine harness to the Miata. We've increased the wire lengths on this harness to allow for more flexibility in positioning the ECU and relays in the cabin.

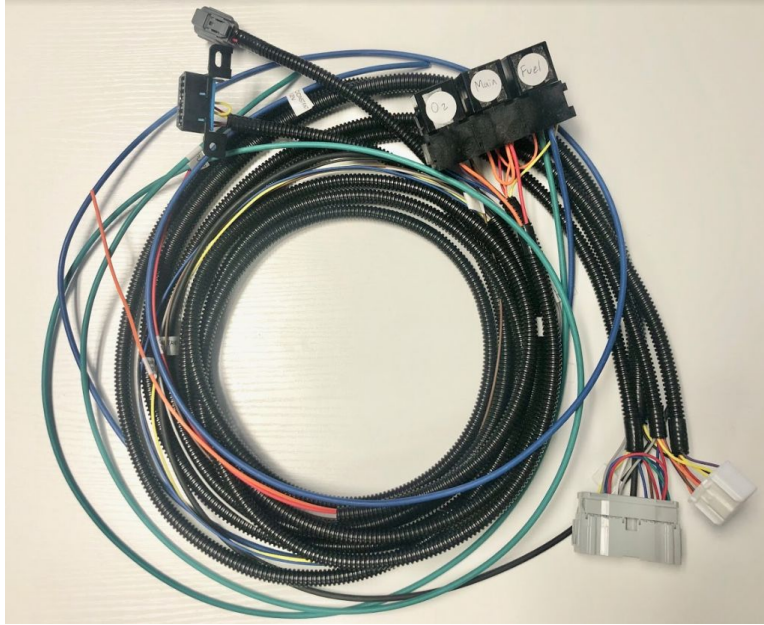

With the K Miata harness connected, you will now splice several wires into the appropriate places on the Miata harness to complete the wiring.

The Miata ECU can be completely removed from the vehicle at this time.

Here is a list of all connections that need to be made, including wire colors and locations (again, this is for a 99-00 only, and although other year cars should be similar, you'll need to look at schematics to see which wire is where). All wires on the KMiata harness are labeled, but we have also included colors for your convenience. Also, the KMiata harness includes three relays built in to make your wiring much simpler: main relay, fuel pump relay, and air/fuel sensor relay. We highly recommend soldering all connections and covering them with heat shrink tubing.

**1) Red - Constant 12V** - Run this wire through the firewall and connect this directly to the under hood 80A main fuse. We like to do it like this:

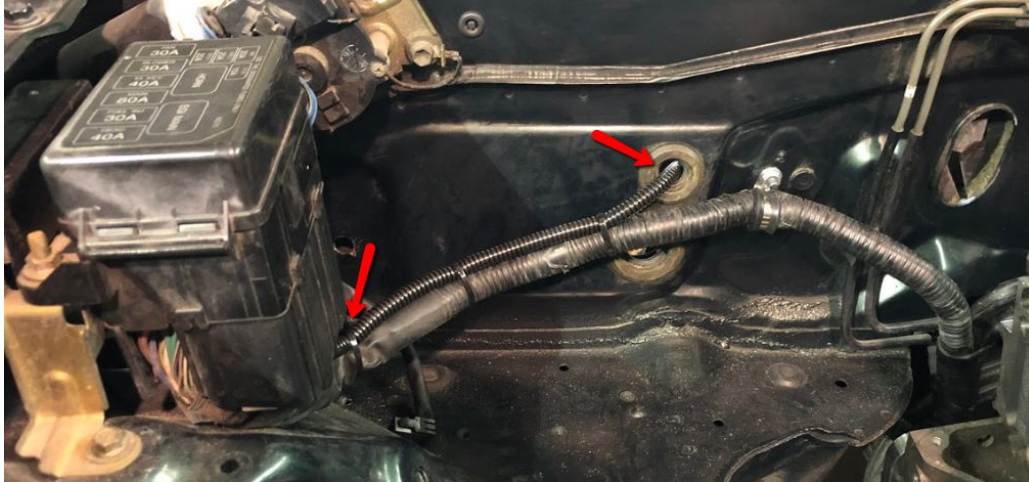

**2) Orange - Switched 12V** - Connect this to the black/yellow engine fuse wire (15A) on the back of the under dash fuse box.

**3) Blue and Green - Fuel pump** - this can be done in one of two ways based on the fuel pump you'll be running. A stock K24Z3 can be run with the stock Miata fuel pump, relay, and wiring. However, we know that customers often upgrade fuel pumps down the road, so we've supplied you with a separate fuel pump relay and wires in our conversion harness that will work with any high flowing aftermarket pump that require a much larger draw. So, if you run the relay we provide, we recommend running the **blue 12v fuel pump wire** directly to the battery (ideally on a 30A fuse) and then the **green "to fuel pump" wire** directly to the fuel pump. You can also run the green wire to the red/blue wire that connects to the stock Miata fuel pump relay, as it runs back to the pump through the stock harness.

If you're certain you'll never be upgrading pumps, you can remove the fuel pump relay from our harness and retain the stock Miata fuel pump relay. The yellow wire going from our fuel pump relay to the E connector in the ECU (pin E9) is the ground trigger for the fuel pump relay. Just route that wire to the stock Miata fuel pump relay block instead of the old trigger wire that runs to the Miata ECU plug.

**4) Black (large) - Starter relay signal.** You also have two options here. This wire needs to ultimately run directly to the starter to trigger the motor to turn on when the key is turned to the start position. On the donor Honda vehicle, this wire is run through the engine harness and the charge harness. To retain the factory configuration, just splice this black wire to the black/red starter wire after the starter relay and after the clutch interlock switch.



Alternatively, this black/red wire also pokes out to the engine back on the passenger side. This wire can be run directly to the K series starter and the black wire can be removed from the conversion harness altogether to bypass the Honda engine harness completely.

**5) RPM signal - Black (small)** - Connect this to the green/orange wire on the back of the gauge cluster (pin 2K).

**6) MIL light (check engine light) - Yellow** - Connect this to the white/blue wire on the back of the gauge cluster (pin 2O).

**7) Oil light/gauge - Brown** - 1995 and up Miatas are equipped with an “idiot” oil pressure gauge, that basically works the same as an oil light. This is why we recommend that an actual aftermarket oil pressure gauge is installed. To make the stock gauge work, connect this wire to the yellow/red wires behind the gauge cluster. 90-94 Miatas owners may want to find a way to attach the OEM oil pressure sender to the K series engine with an oil filter sandwich plate.

**8) Radiator fan control - Blue (small)** - Connect this wire to the red/green wire behind the factory green Miata ECU plug. This will allow the K series ECU to trigger the fan relay in place of the Miata ECU.

Once all your splices are completed, you'll need to secure the OBD2 scanner port on the KMiatas conversion harness under your dash if you plan on passing emissions in most states. It should be long enough to run it in the factory scanner port location. For race cars, this port can be mounted anywhere you would like.



**9) Miata Coolant Temp (ECT) Sender** - this is not a part of our harness, but if you're retaining the stock Miata temperature gauge, you can install the stock sender into the extra port of our upper water neck. Only one of the two (NA) or three (NB) wires is needed to make the gauge function. On an NB, extend the violet/white wire back to the violet/white wire on the back of the gauge cluster. The sensor will already be grounded since it's mounted to the head, and the third wire on the NB is for the ECU signal. Since you're running the K series ECT to the K series ECU already, you don't need that

Our wiring harness also includes the four pin connector for the OEM wideband o2 sensor. On K24Z3 engines, you can install it in the cast downpipe elbow or further downstream in the lower o2 bung. Either will work fine.

Note: The KMiata harness comes with an output for VSS (vehicle speed sensor). In either KTUNER or Kpro, disable the VSS input to the ECU. Your speedometer will work automatically since you have retained the factory transmission. We have included the VSS wire only for those users that are interested in tuning by speed or gear, specifically with boosted applications. New Kpro software has provisions for a wide range of VSS signals.

**IMPORTANT:** you will need to upgrade your engine fuse from 15A to 20A, and the room fuse from 10A to 15A. If you don't, you'll likely blow a fuse on your first drive.

We recommend completing the remaining steps of this guide before re-installing the dash. Then plug in the gauge cluster and start the car to troubleshoot any problems with your wiring. Assuming all is well, neatly tuck all of the wiring up along the firewall using zip ties as necessary. We also highly recommend wrapping any loose wires in split loom to keep them protected.

## **Engine Grounds**

Proper grounds on the K series engine are extremely important! The following three chassis grounds should be included on every single K series swap, no exceptions:

- 1) Engine block to chassis
- 2) Timing chain cover to chassis
- 3) Transmission to chassis

Our ground locations should be clean and free of paint or rust, and we recommend large 4 gauge ground wires.

In addition to the chassis grounds, be sure that the engine harness grounds are in place. The RSX-S harness has a single ground by the injectors, that should be attached under one of the 10mm valve cover nuts.

The Element harness has TWO harness grounds. One by the injectors that gets attached to the valve cover, and a second smaller ground that attaches on the back of the head. If these are not in place, your car won't start!

### **Intake Manifold Installation**

At this point the intake manifold, throttle body, and appropriate sensors can be permanently installed.

On a K24Z3 head, thread the supplied 90 degree ½" NPT fitting into the lower thermostat bypass port with some pipe tape. Turn it until the fitting is pointed towards the front of the car and then clamp on the stock thermostat bypass hose to it.

Next, install the idle air control valve (IACV) from a 2003-2005 Accord to the bottom of the manifold using the supplied M5x.80 bolts. One of the barbed fittings can also be installed in the lower port, which is the inlet for the IACV throttle body bypass. This will get routed into the intake piping somewhere in front of the throttle body.

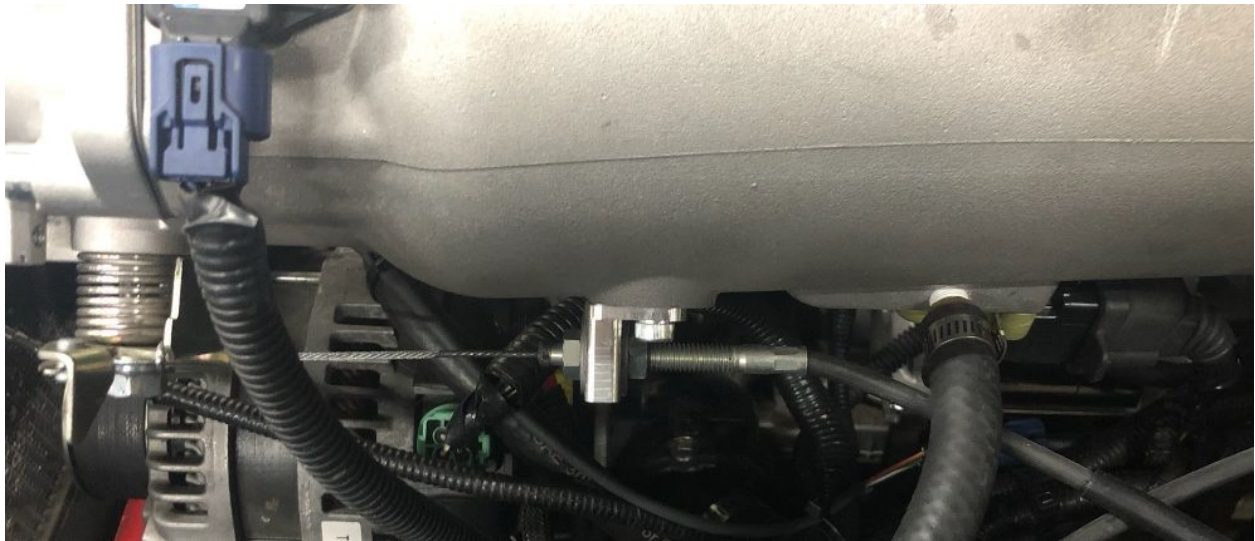

The supplied throttle cable bracket can also be installed. The throttle cable bracket provided is meant to work with an NB Miata cable. If you have any NA, you'll need to use an NB cable as the NA cables are very long and not suitable for this application. Cut the rubber grommet off the cable and clamp it in place tightly with the two 12mm nuts.

Before the throttle body is installed, put a dab of Hondabond in the B series MAP port on the bottom of the throttle body since you won't be using it. Once that's done, bolt it to the manifold with the supplied gasket and bolts. The TPS and MAP sensors can also be attached at this time.



Note: We highly recommend against using the plastic “thermal” gaskets on the market, as they often cause manifold flanges to crack. An OEM style thin gasket is always preferred.

### **Downpipe and Exhaust Installation**

Because the downpipe is installed, bolt on the lower flywheel dust cover. The downpipe installs in two sections, with a gasket between the downpipe and head, and then between the two flanges near the motor mount.

Additionally, an exhaust grommet is supplied to secure the rear of the downpipe to one of the transmission bolts for extra support. Due to the tight clearances with this exhaust setup and minor manufacturing variations, the pinch weld on the inside edge of your subframe may need to be cut a bit to provide adequate clearance.

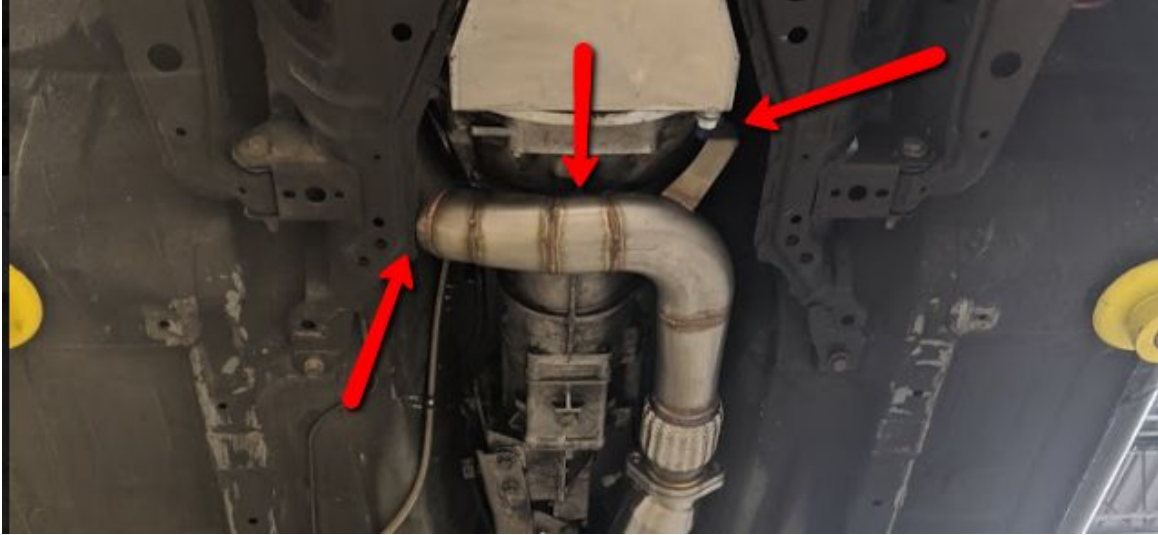

Additionally, six speed transmission users may need to grind down a bit of material directly above the oval crossover to avoid the downpipe rubbing on the bellhousing.

Once the downpipe is in place, our optional 3" exhaust can be bolted into place.



## **Fuel Lines and Pump**

Our testing has shown that a stock K24Z3 engine receives enough fuel from a stock Miata fuel pump, so no upgraded pump is necessary. However, replacing the pump with a Walbro 190 or 255lph pump isn't a bad idea, especially if your factory Miata pump is still original.

1990-1997 (NA) Miata uses a RETURN fuel system. This means that fuel is pumped out of the tank to an external fuel pressure regulator (FPR). Extra fuel is then routed back to the tank via a return line.

1999-2005 (NB) Miata uses a RETURNLESS fuel system. This means that there is an in-tank FPR, and only a single line is run from the fuel tank to the fuel rail.

The K series engines also use a returnless system, making the NB fuel setups very easy.

This can be set up in a variety of ways. The easiest and least expensive option is to bend the factory line towards the back of the engine bay and away from a header and use OEM-style plastic fittings to run to an OEM fuel rail:



Additionally, AN fittings and lines can be used. Just cut the factory 5/16" hard line under the car, and use one of the -6 AN to hard line adapters on the market. We offer Hybrid Racing fuel rails that accept a -6 AN hose, and also allow a fuel pressure gauge to be installed on the rail.

NA users will need to run an aftermarket fuel pressure regulator to the fuel rail, just as all older FWD Honda K series swaps require. The recommended routing for this setup is:

Fuel pump > inline fuel filter > fuel rail inlet > fuel rail exit > fuel pressure regulator > return line

### **Radiator, Cooling, and Hoses**

While KMiata may eventually offer custom radiator hoses, we find that using readily available off-the-shelf hoses is quite straightforward.

We use Dayco hose #71718 for a perfect fitting lower hose.

The upper hose can be done in a couple different ways. We prefer to use a 90 degree hose elbow (like one of the stock Miata hoses) and run it to a piece of 1.25" aluminum tube (available from Vibrant, McMaster Carr, and other sources).



Finally, if you are running heat, you'll need to cut the lower heater pipe shorter and run a couple 5/8" heater hoses to the heater core, like this:



If you are not running heat, plug the upper port with the supplied ½" NPT plug, and we recommend the K-Tuned lower heater hose delete kit to plug the OEM plastic thermostat housing.

### **Intake Piping**

Once everything else is done, intake and exhaust can be put in place. For best power, we recommend 3" intake piping. On a track car, it's important to get the air filter out of the engine bay and try to get at least 18" of intake length. On an NB we do this by cutting the chassis a bit behind the left headlight so a 3" pipe fits through the opening.



For a street car, it's less of an issue to keep the filter inside the engine bay with a simple setup like this:



### **Initial Startup Instructions**

Extra care should be taken to start up your car for the first time.

Before adding oil, unplug the upper overflow plug on the oil pan. Once you add about 6 quarts of oil, it should spill out of the overflow. That is the required oil level for safe operation. We recommend marking your shortened dipstick and maintaining this oil level at all times.

Before the first start up, disconnect all four injector plugs and crank the starter for about 60 seconds so oil can start to be pulled into the oil pump and the bearings are not run dry. Once this is done, reconnect the injectors. If you have done everything correctly the engine should fire right up.

To burp air from the cooling system, we recommend using a "Magic funnel" that clamps on to the top of your radiator. Additionally, you will likely need to jack up the front of the car to help air bubbles in finding their way out of the system.

Additionally, you may need to squeeze the radiator hoses to get the liquid moving as it warms up. Sometimes this process is quick. Other times it may take an hour or more, and will require shutting off the car once or twice.



Once your radiator fan is on, your coolant is steaming out of the funnel, and the temperature has stabilized, you're good to go for a test drive.

Before starting your vehicle, feel free to email us for a baseline tune to upload to your ECU.

Congratulations on successfully converting your Miata to K series power! If you have any installation questions or have any feedback on this installation guide, please email us at [sales@kmiata.com](mailto:sales@kmiata.com).

## **Troubleshooting**

In an effort to help our customers diagnose any wiring issues with their builds, we've now included some steps to check in case your engine doesn't fire up immediately. Diagnosis beyond these simple checks should be done by a qualified technician with a thorough understanding of vehicle wiring.

- 1) **GROUNDS.** Check them all, make sure there is continuity to ground everywhere. This can't be stressed enough. Don't forget about the engine wiring harness grounds!
- 2) TPS and MAP sensors need to be plugged into the correct places on the harness. The car will not start if they are mixed up. It will also prevent the ECU from fully powering up, and will keep the fuel pump from kicking on.
- 3) Make sure when the vehicle is keyed on, a check engine light appears, the main relay clicks, and the fuel pump relay kicks on the pump for a couple seconds to prime it. All of these things must happen in order for your vehicle to start. If one is not happening, check steps 1 and 2, and recheck your wiring.
- 4) No fuel or no spark? Check continuity back from the coils and injector connectors back to the ECU. Check continuity from all other sensors back to the ECU.
- 5) Make sure all sensors, especially the crank and cam sensors, are undamaged and in good working order. If using a used harness, make sure it is undamaged with no shorts to the chassis or exposed wires.
- 6) If using Kpro or KTuner, make sure a tune is actually uploaded to the ECU. If the ECU is empty, the car will not fire up.
- 7) Make sure the immobilizer is disabled in either Kpro or KTuner. All reflashed ECUs come with the immobilizer already disabled.
- 8) Check that all pins in the conversion harness are in place, particularly the ones in the relay blocks. The harness should be handled with care, and mounted in a safe location so no wires can get caught and pulled out of place.
- 9) If using a used alternator and starter, make sure they are in good working order by bench testing them. Keep in mind that any used components could potentially be non-functional.

## Commonly Used K series Torque Specs

Valve cover	7.8 lb-ft
Camshaft caps	16 lb-ft
Intake cam gear	83 lb-ft
Exhaust cam gear	51 lb-ft
Intake manifold	16 lb-ft
Exhaust manifold	33 lb-ft
Timing chain case	8.7 lb-ft
Crank pulley	181 lb-ft
Windage tray	8.7 lb-ft
Oil pump 8x1.25	16 lb-ft
Oil pump 6x1.00	8.7 lb-ft
Oil pan	8.7 lb-ft
Flywheel	90 lb-ft
Pressure plate	20 lb-ft