



UTV & ATV Armor Kit Installation Tips

Thank for your purchase of this Ricochet Off-Road Armor Kit. All of our kits are custom designed to fit each model and should install hassle free with no additional modifications required. Please carefully read through all included instruction sheets before beginning your install.

The tips described on this sheet are general mounting tips that may or may not apply to your particular model, refer to the attached model specific instructions for a step by step mounting procedure.

If you do encounter a problem during installation please check the FAQ on our website or feel free to contact us by phone or email using the contact info at the bottom of this page.

Required Tools:

(refer to your hardware placement guide for bolt sizes)

Button Head TORX Bolts: (socket bit is highly recommended)

8mm bolts use a T-40 TORX bit

6mm bolts use a T-30 Torx bit

Hex Bolts & Nuts:

10mm bolts uses 17mm

8mm bolts uses 13mm

6mm bolts uses 10mm

1/4"-20 bolts uses 7/16"

Drill Bits:

While we try to avoid drilling whenever possible some models require one or two mounting points to be match drilled. When instructions call for a drilled mounting point use an **11/32"** bit to match drill through the mounting point on the skid plate only after the plate has been fully secured to your machine using the other hardware listed on your hardware guide.

Locking Nuts:

Most sets will include two types of locking nuts. Loose nuts are Nylock, and any nuts welded onto other hardware are pinch-style Stover lock nuts. It is highly recommended that you use a bit of Anti-seize or a drop of oil on the threads of the welded-on pinch style nuts, this will make the bolts go on and come off much easier.

Other helpful tips:

- Before you begin the installation organize all the included hardware according to the hardware placement sheet so you can quickly find the correct bolts and brackets when you need them.
- Install all bolts finger-tight at first until all hardware has been installed, this will give you maximum adjustability.
- When using the cupped washers to secure the plates to factory mounting points do not over torque the bolts because the threads can strip easily. If you do strip one out the simplest way to repair the thread is to use a 1/4"-20 x 5/8" self tapping bolt.
- You may find it easier to remove the rear tires when installing the rear a-arm guards, it's typically very tight and hard to see when the tires are left on.

Contact us at 1-866-273-1197 or dh_gibbs@comcast.net with any questions or concerns.

Hardware Placement Guide for P/N 7955X

8 x 45mm Button Head Bolts
 8mm Nylock Nuts
 2x 8mm HD Washers

749AFA

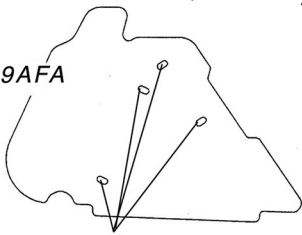

1" Clamp
 8 x 20mm Button Head Bolt
 8mm Flat Washer

749T

8 x 40mm Button Head Bolt
 (8 x 35mm if no bash plate)
 8mm Nylock Nut
 2x 8mm HD Washers

749AFB

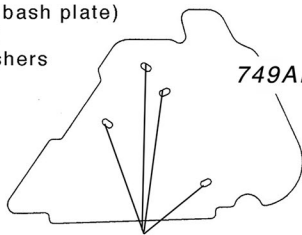

1" Clamp
 8 x 20mm Button Head Bolt
 8mm Flat Washer

749B

#836 Square Clamp
 8 x 20mm Button Head Bolt
 8mm Washer

6 x 60mm Hex Bolt
 6mm Nylock
 2x 6mm Flat Washer

749M

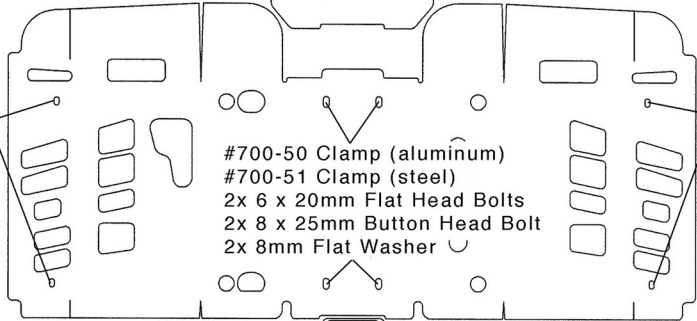

#700-50 Clamp (aluminum)
 #700-51 Clamp (steel)
 2x 6 x 20mm Flat Head Bolts
 2x 8 x 25mm Button Head Bolt
 2x 8mm Flat Washer

6 x 60mm Hex Bolt
 6mm Nylock
 2x 6mm Flat Washer

1 1/2" Clamp
 8 x 20mm Button Head Bolt
 8mm Flat Washer

749ARA

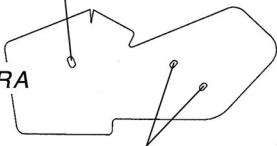

6 x 20mm Button Head Bolt
 6mm Nylock Nut
 2x 6mm Flat Washer

795M

8 x 70mm Button Head Bolt
 8mm Nylock Nut
 8mm Flat Washer
 8mm HD Flat Washer

#700-06 Nut Plate
 8 x 45mm Button Head Bolt
 8mm Flat Washer

1 1/2" Clamp
 8 x 20mm Button Head Bolt
 8mm Flat Washer

749ARB

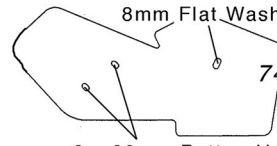

6 x 20mm Button Head Bolt
 6mm Nylock Nut
 2x 6mm Flat Washer

8 x 70mm Button Head Bolt
 8mm Nylock Nut
 8mm Flat Washer
 8mm HD Flat Washer

795R

#836 Square Clamp
 8 x 20mm Button Head Bolt
 8mm Flat Washer

1 1/2" Clamp
 8 x 20mm Button Head Bolt
 8mm Flat Washer

749ARA

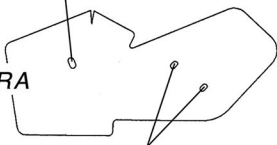

6 x 20mm Button Head Bolt
 6mm Nylock Nut
 2x 6mm Flat Washer

8 x 40mm Button Head Bolt
 #700-37 Nut Plate
 8mm Flat Washer

1 1/2" Clamp
 8 x 20mm Button Head Bolt
 8mm Flat Washer

749ARB

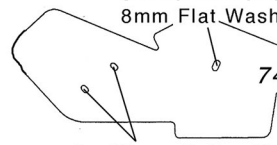

6 x 20mm Button Head Bolt
 6mm Nylock Nut
 2x 6mm Flat Washer