

DETAIL Y
SCALE 1:4

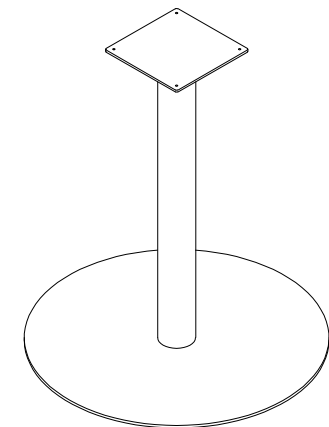
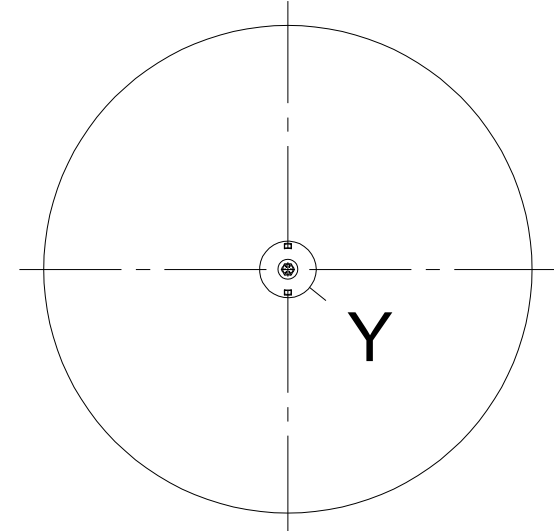
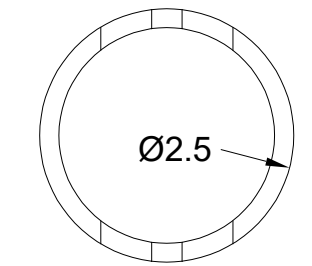
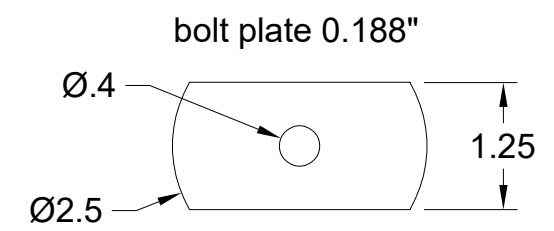
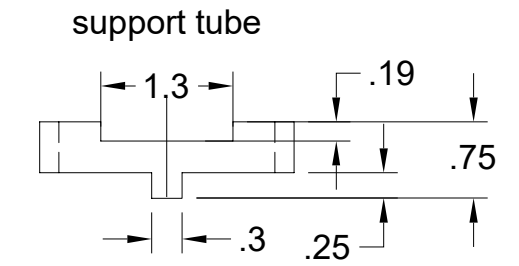
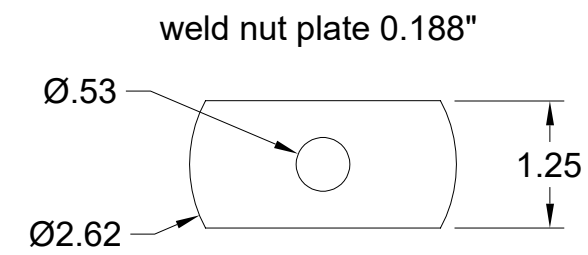
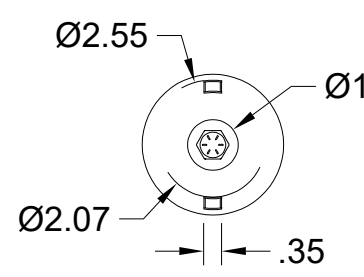

NOTES:
 1. PART TO BE FREE OF BURRS AND SHARP EDGES.
 2. ALL WELDS TO BE FREE OF SPATTER.

PROJECT				
Symmetry Hardware				
TITLE				
Ped Base Round				
APPROVED	SIZE	CODE	DWG NO	REV
CHECKED	B			1
DRAWN ZKO	17.5.2023	SCALE 1:16	WEIGHT 46.37 lb	SHEET 1/1