

 *Plastica*



Nazca Wooden Pool with Strap System

Self build installation guide for the 4x2m
Nazca Wooden Pool



www.woodenpools.net

Contents

Introduction	3
Recommendations for storage after delivery	3
Natural Timber Characteristics	4
Preparing the Base	5
Building the Concrete Base	6
Total or Partial In-ground Installation	6
Building the Timber Structure	7
Understanding the Wooden Wall Profiles	7
Building the Wall Structure	8
Installing the Strap System	11
Building the Wooden Step Ladder	14
Installing Wooden Top Ring-Beam and Support Blocks	15
Installing Vertical Supports: Part 1	17
Installing the End-capping Channel	19
Fixing the Top Shelving	20
Installing Vertical Supports: Part 2	22
Installing the Liner-lock, Fitting Inlets/ Low-level Suction or Vacuum Point	24
Laying the Felt Underlay	25
Foam Wall Protection	27
Installing the Liner	28
Installing the Pipework & Equipment	34
Installing Low-level Suctions/Inlets	35
Installing the Skimmer(s)	36
Installing the Stainless Steel Ladder	37
Tool Kit	39
Warranty	40

Introduction

A video is available on our wooden pools website www.woodenpools.net. The video shows a project from start to finish and is an informative guide to compliment this book. For detailed instructions please primarily use this book. You are advised to watch the whole video and read this complete book before starting your project.

In the event of any problems please contact your dealer immediately. Warranty claims may be affected if there is a delay in reporting a problem or if these instructions have not been followed.

Tools required are listed at the end of this book

Recommendations for Storage after Delivery

- Do not store the timber in direct sunlight or under a dark cover as this may cause distortion which will make installation extremely difficult.
- Assemble the structure as soon as possible after receipt.
- Assemble the structure in one go, preferably in the morning while temperatures are cooler.
- If a timber product must be stored, then use a cool well-ventilated place, sheltered from the rain and sun.
- Components that are damaged, cracked or distorted due to incorrect storage and/or handling will not be covered by the warranty.
- **Please ensure the liner is stored in a warm environment before installation.**

In the pre-assembly period, wood is sensitive to variations in temperature and humidity. It is therefore necessary to take precautions immediately after delivery.

Wood is a living material and once cut, the appearance of cracks, slight movements or changes in colour are normal and the planks (except in extreme circumstances) do not need replacing. The planks will have been recently treated and may still be moist when delivered.

In the case of rapid temperature change these planks can dry very quickly and lose one or two millimetres in height. This might give the impression that the planks are lifting but they are actually shrinking, whilst in cooler wet conditions the wood may expand back to its original size. This is completely normal.

Please note: some of the images in this installation manual may be from another type of pool and are being used for illustration purposes only.

Natural Timber Characteristics

Whilst we try to ensure that our timber products reach you in perfect condition, we are dealing with a natural material and there are many characteristics which can arise. These are completely normal and have no detrimental effect on the product.

We manufacture our products so that most natural characteristics are inside the product where you wouldn't see them, or the plank may be reversible so it can be used either way around.



Shake appears like a series of splits. With a timber section of this size you will always encounter some degree of this (usually on one side). This does not affect the strength of the product and you will find the shake opens in continued warm weather and then closes when the weather is wet and cooler or there is a lot of moisture in the air.



Pith is similar to the above characteristic and quite often found along side each other.



Knots & Sap are typically found in timber as shown. These are not generally an issue and can actually be beneficial, relieving stress points in timber. These can add character to the product. Sap can also be present and can be carefully scraped off with an appropriate tool.



Cupping is mainly caused by the treatment of the timber. Where timber is kiln dried and then pressure treated it can cause cupping. Although we limit this, the best way to counteract it is; as you build the walls of your product, have one plank with the growth rings facing one way and the next with the rings facing the opposite way (counter cupping). This is only possible on square or rectangular products as the planks are reversible. On octagonal products if you have a problematic plank try it in another wall position to see where it will fit best.



Please note we cannot accept returns for natural characteristic complaints (except in extreme circumstances, at the supplier's discretion). This includes planks which may arrive damp or containing mould residue (this is not a lasting or detrimental factor). Any damage caused by poor handling or failure to follow instructions is not covered by our returns or warranty procedures.

SAFETY NOTICE

Unless your filtration kit (filter, pump and any optional heating) is housed within a secure waterproof filtration enclosure, it should be placed at least 2 metres away from a swimming pool. You may need to purchase additional pipe and fittings if a filtration enclosure is not being used.

It is important to ensure the electricity supply for the filter pump or any other electrical equipment, has a 30 mA RCD protection circuit and conforms to current electrical regulations.

NEVER LEAVE CHILDREN UNATTENDED AROUND THE POOL WHEN COMPLETED OR ANY STAGE OF THE CONSTRUCTION.

The pool is designed for domestic use. Running along the top shelving, diving, or jumping in from the edge must not be allowed under any circumstances. The pool is not suitable for the addition of a diving board.

Preparing the base

You will need to either have a flat/level pre-existing hard standing, or create a solid base for your pool to stand on. **Our recommendation would be a 150mm thick concrete base with reinforcing mesh.** However, if you are confident that the area where the hard standing for the pool is strong enough you can start building the structure. If you are unsure, consult a ground engineer as you may need to modify an existing base. It is very important that the result on the concrete is smooth and level as water will always find a level and show, if the pool structure is not level. Due to this pool having a strap system the user may want to put a thin screed inside the pool to hide the strap. This must be level and smooth as any imperfection in the floor will show through the floor of the liner.

Below is the recommended concrete base size to suit the Nazca 4x2m pool.

BASE LAYOUT DETAILS FOR STRAP SYSTEM 4M x 2M NAZCA
 ISSUE 1 - JK 21/06/2021
 PLEASE REFER TO MAIN INSTRUCTIONS FOR STRUCTURE ASSEMBLY

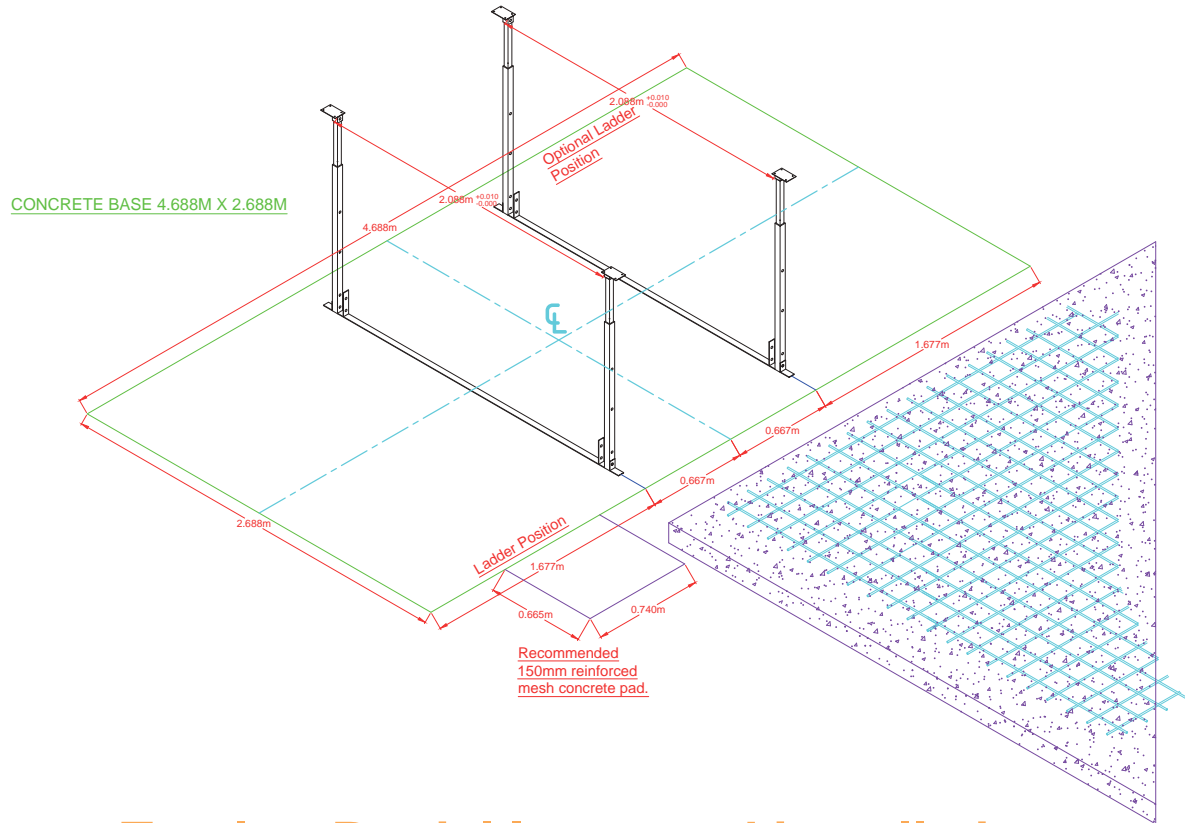

Total or Partial In-ground installation

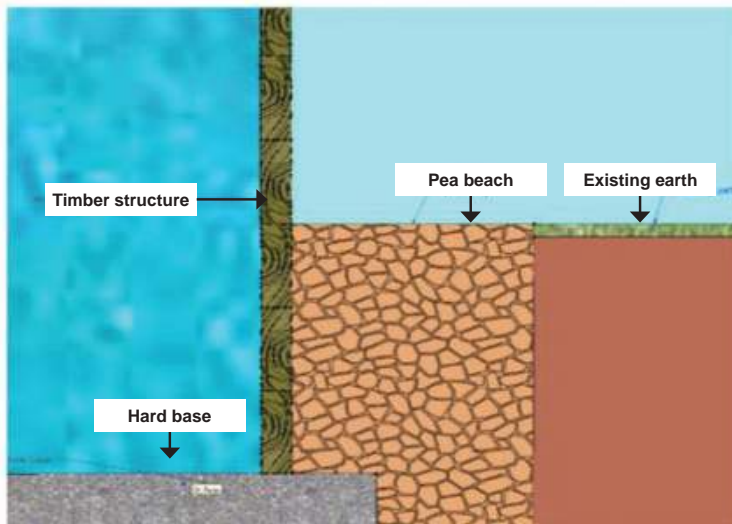

Plastica Wooden Pools can be installed above ground, partially in or fully in-ground. However, if you do have the pool fully or partially in ground you will need to ensure that there is adequate drainage so that the timbers of your pool are not to be permanently submersed in water. Use an adequate amount of pea beach around the structure, if possible with a run off to a soakaway or similar, so that water cannot build up around the structure and rot the timbers. If an adequate amount of drainage in the form of pea shingle or similar has not been used, this may affect the warranty.

This product has been treated with ACQ which is child play friendly and is warrantied against

rot and insect attack (10 years on 44mm wood and 5 years on 27mm wood). However, if this product is being installed completely or partially below ground level you will need to install adequate drainage around the pool. We recommend 300mm - 450mm width of pea shingle, all the way around the product. Never use a plastic membrane around the outside of the product as this will accelerate any deterioration of a timber product.

The timbers are treated for ground contact only and are not to be submersed permanently in water. Please also note that any modification to a wooden structure, including drilling or cutting of a wall plank will void the warranty on the modified plank. As a precaution, if you do require to modify a plank, we suggest that you treat the cut area with a good quality timber preservative if below ground level. Ensure any treatment does not come into contact with the liner.

Building the Timber Structure

Please check the contents list and drawing to establish that all parts are present on delivery, you must report any damaged or missing items as soon as possible.

Top Tip: lay out the wooden wall planks in an orderly fashion in the centre of the pool to be built. This will save you from having to climb in and out of the pool too much and could save you time and money.

Understand the Wooden Pool Wall Profiles



Note: the four different types of profile used for building the structure walls.

Building the Wall Structure



Once you are satisfied with the base for the wooden pool, locate the strap systems and the long bottom half planks with the small slots machined out. Place the strap set under and within the slots of the long half planks.



Once you have located the strap system in position, lay two standard planks over the bottom half planks.

Next, use standard planks to form the first layers/outline of your pool. Interlock the notches on the planks. From this point onwards, it is essential that you use the Knocking Block provided (see picture below) and do not use a mallet directly on the pool timbers, as it will flatten the tongues and may damage the timbers, making it extremely difficult to install the pool walls.



When fitting the wall planks, make sure to place the plank down evenly over both notches and locate the tongue and groove between each plank before using the mallet to close the tongue and groove tightly together. The plank should go downward with the plank remaining horizontal. When installing longer planks, get somebody to help you do this. The best way to install longer planks is two people tapping the plank downward at each end and locating the plank properly before it tightly together.



Knocking Block



Once you have 2 full planks on the ends of the pool, you can install the low level suction plank (hole located offset) and inlet plank.

(Hole located in the centre). We have installed the inlet and low level suction at opposite ends of the pool as this will increase water-flow. It is not usually necessary on small pools but on larger pools it helps gain better circulation of water. To do this, extra pipework would need to be purchased from your retailer.

Can be installed at the same end of the pool. However, it would be better to install the inlet one plank above the low level suction on the 4th layer.



The picture shows the cut out for either a low level suction or inlet, (note the flower pattern is on the inside of the pool).



Continue to lay down the planks until you reach the 8th plank from the ground on the filtration wall and insert the vac point plank. This will need to be installed on the same wall as the low-level suction.



This picture shows the cut out for either a low level suction or inlet, (note the flower pattern is on the inside of the pool).



Continue to lay planks until you reach the lower skimmer plank, the recess must be in the inside of the pool, see image below.



WARNING!

The skimmer must be placed into position before adding the upper skimmer plank, otherwise you will have to partly dismantle the pool to install the skimmer.



Once you have placed your skimmer in position, continue to build the layers of the pool. The structure wall will finish with two and half planks.



Level the skimmer and fix in place using the 40mm x 3.5mm screws provided in the Fixing Kit.



Note the four fixing positions.

You may need to drill pilot holes. This will need to be done before fixing the unit to the wall.



Insert the wall fittings for the inlet, low-level suction and vac point using the 3.5mm x 20mm screws provided in the Fixing Kit. Keep all gaskets, screws and face plates safe until the liner is installed.

Installing the Strap System



With the straps in their positions, insert the 40mm box section between the structure wall and the outer part of the bracket on the strap system.



Make sure it is vertical using a spirit level, then drill a 10mm hole through the timber wall.



Try and ensure the drill bit comes in the middle or as close to the middle of the hole on the strap system.



Gently tap an M10 coach bolt through the wall from the inside of the pool. Be careful not to damage the thread on the metal whilst inserting it, as this will make it difficult to attach a nut. When this is tightened, the bolt head should be sitting flush against the strap system.



Carry on drilling and inserting bolts through the wall into the box section.

On the outside of the pool connect the M10 nuts and washers to the bolt and tighten, ensuring the upright section is vertical with a spirit level.



Now install the top bolts on the insert sections ensuring they are vertical. This should be flush with the top of the pool. Try and tighten the bolt at the top of the pool so that the dome on the inside of the pool is as flush as possible with the timber, as this will make the liner-lock installation easier later.

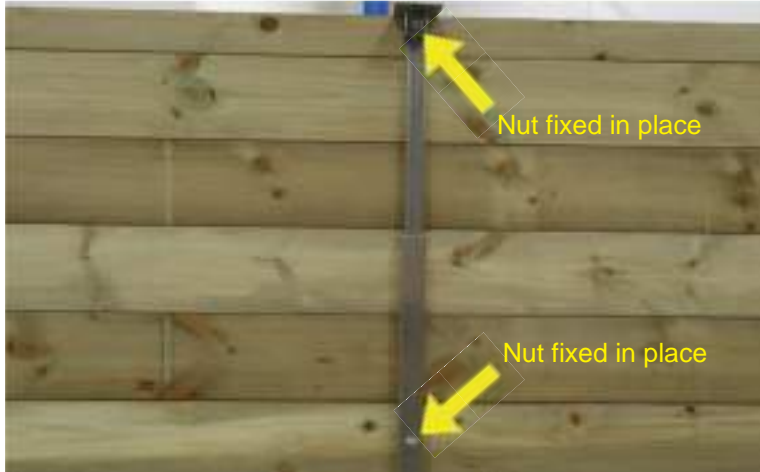

Building the Wooden Step Ladder



To help with the ring-beam installation and to make it slightly easier, the external ladder needs to be assembled as follows:

Lay down one of the wooden step sides, then insert all four treads into the slots machined out of the step side. It may need tapping gently in place with a rubber mallet.



Carefully insert the treads into the other side and press the steps together.



Carefully mark two holes on each of the treads and fix two coated screws 4.5mm x 65mm. Turn the unit over, ensuring everything is in place and repeat marking and fixing two screws to each side of the treads.



When you have finished assembling the wooden ladder put it aside until it is required to help with the installation of the ring-beam.

Installing Wooden Top Ring-Beam Support Blocks



Examine the laminated drawing provided carefully. There is a large timber (ring-beam) which runs around the perimeter of the pool at the top of the structure walls. This gives strength and support to the top of the pool, whilst also providing a fixing point for the top shelving. Take note on the provided A3 laminated drawing of the positions of the ring-beam and ring-beam blocks and carefully mark out locations. You will note that the ring-beam sections are pre-cut for the skimmer and ladder sections.

Please ensure the ring-beam timbers are not mixed up and used in the correct positions.



Fix the ring-beam blocks on your marked positions from the inside of the pool using the 5mm x 100mm screws.



On the inside of the pool use two 100mm gold screws to fix the ring-beam blocks.



When installing ring-beam and the ring-beam blocks pay particular attention to the skimmer and ladder locations ensuring the correct parts and positions are used.

Note: on the outside of the pool, either side of the skimmer or ladder positions, 6mm x 150mm Hex-head screws are used. Also, it may be necessary to trim either ring-beam or ring-beam block if it's too tight.



At every cross section in the main timber walls the 150mm x 6mm Hex-head screws must be used to fix the main ring-beam in place. Use a small section of the end-cap channel and place it on the end of the wall. This will help gauge the location of the ring-beam. It may be necessary to trim the ring-beam to fit.



Use the longer ladder ring-beam blocks in accordance with the drawings. Place your wooden steps against the wall ensuring it is seated properly against the floor and the wall. This helps set the spacing for the wooden steps.



This picture shows the installed ring-beam with ladder positioned.



On the outside of the pool, when fixing the ring-beam to the ring-beam-blocks, the majority of fixings are the 5mm x 70mm stainless countersunk screws as pictured left. Use the screw digger supplied in the Fixing Kit to countersink the screw hole slightly, this makes a neater fixing.

Installing the Vertical Supports: Part 1



Mark and cut the vertical supports and metal brace covers now but do not fix them in place yet as you will need to access two bolts on each set of strap set supports.

Firstly, mark the full height of the vertical supports and cut to length based on the wall and ring-beam height.



Next, individually mark each vertical support at the bottom of the ring-beam. Measure the distance from the outer wall to the inside of the ring-beam (it measures approximately 123mm).



Cut out the required amount, so when the vertical support is snugly in place it is no higher than the pool wall and sits nicely under the ring-beam.



Vertical supports should look as in the photograph when placed into position.



Measure and cut each metal brace cover to suit each set of vertical supports.

Do not fix anything permanently in place, this needs to be done once the top shelving has been fitted.

Installing the End-capping Channel



Fit an end-capping to each end section of wall, you may need to gently tap it in place with a rubber mallet. Then mark it with a pencil and cut to length.



Work your way around the pool trimming each end-capping to length.



Fix each end-capping in place using the 4.5mm x 65mm screws provided in the Fixing Kit.

Fix one into the top and bottom planks of each wall section, then two more spaced out evenly between the top and bottom screws. In total there should be four screws per end-cap channel.

Fixing the Top Shelving



The top shelving which surrounds the pool comes with four inner planks and four outer planks. When a section of top shelving joins another, stainless steel biscuits are slotted into a machined groove at the end of each plank, these should be used at every join.

Take your time to evenly space out the top shelving and manoeuvre it into the correct position. This is usually one of the trickiest parts of the build, so it is worthwhile taking your time and going around the pool, double checking everything before you start fixing it.



It is best to start with the outer shelving, measuring the back edge of the top shelving to the end-capping channel, so you can ensure you have an even overhang all the way around the pool.



Locate the top shelving packed with the label, this is the skimmer hatch, please ensure you do not lose any of the components, this particular plank is an outer shelving.

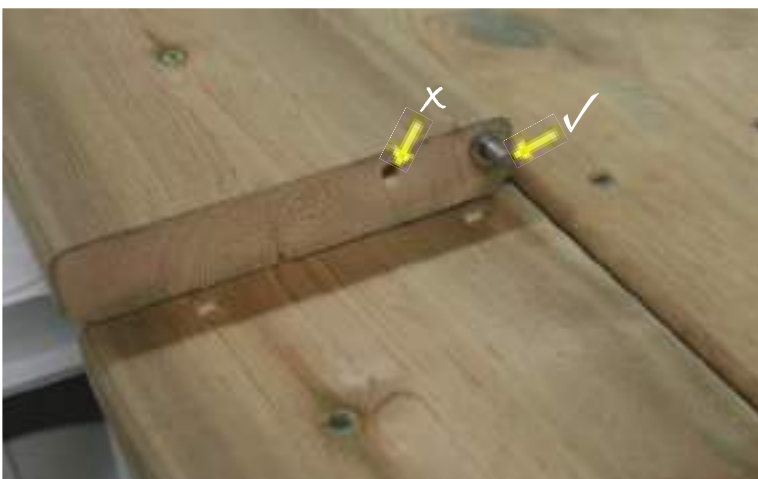

Make sure you use the hole at the edge of the timber, this will be the pivot point for the skimmer hatch, you should also have two washers per pin.

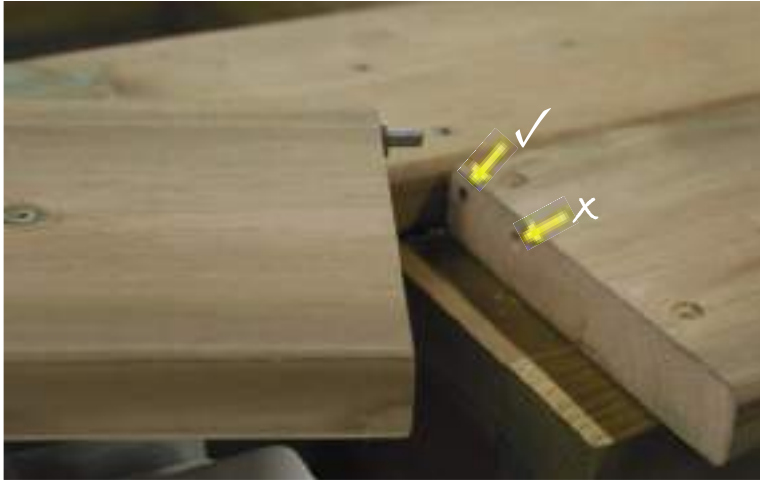

Connect the outer top shelving to form the skimmer access hatch.



Use a straight edge to line up the outer edge of the top shelving with the skimmer hatch to keep it in a straight line. You must make sure that when you mark out screw positions the screws will not come into contact with the liner or Liner-lock. Any warranty for a mechanically damaged liner will not be covered.



When you have connected the inner top shelving using the stainless steel biscuits, take your time to align top shelving evenly to create a gap between the inner and outer top shelving, of a similar size.



Use the 4.5mm x 65mm coated screws to fix down the top shelving. There should be two screws fixed per board at every support point i.e. ring-beam blocks, vertical supports and wall sections. Top tips: use the screw digger bits supplied with the Fixing Kit to pre-drill to a shallow depth and slightly counter sink for a nice clean finish. Also, you can use timber wedges or a clamp to open or close gaps in the top shelving if a board has a bend in it.

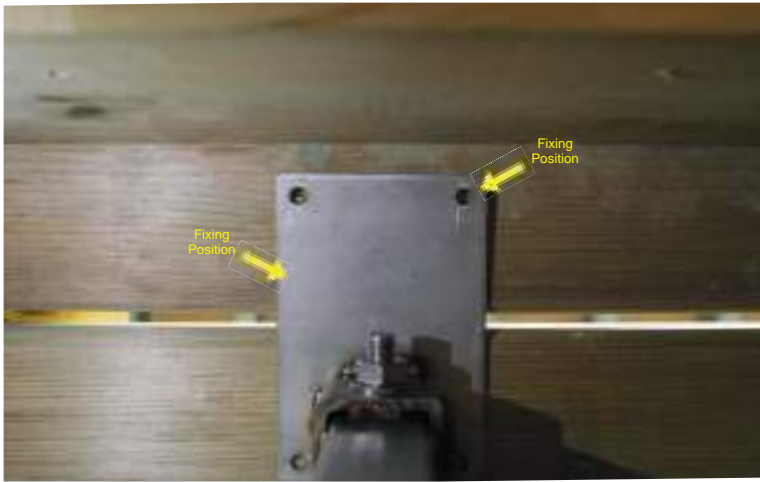

Finally, with regards to the top shelving drill two 6mm holes as vertical as possible through the two fixing positions of the strap system bracket. With a sharp drill bit and careful drilling you should have two nice holes to insert some M6 x 40mm coach bolts, supplied in the Fixing Kit. Repeat this for all the fixing brackets on the two strap systems.



Insert the M6 x 40 coach bolts and tighten using supplied M6 nuts.

Installing Vertical Supports - Part 2



Once you have secured the strap system to the top shelving, you need to fix the vertical supports and metal brace covers in place.



Place the vertical supports in the correct position.



Use the metal brace cover to ensure the correct spacing between the vertical supports, by using the width of the board as a guide.



On the inside of the pool using the 100mm screws provided in the Fixing Kit. Fix a screw into the vertical supports through each wall plank as shown. It is best to use a spirit level and fix a screw at the top and bottom of the wall first, then fix a screw through each individual plank. It is handy to have another person on the outside to hold the vertical supports against the wall while you do this.



On the outside, fit four 5mm x 70mm stainless screws (supplied in the Fixing Kit) through the ring-beam into the vertical support.



Finally, fit the metal brace covers using ten 4.5mm x 65mm coated screws per brace cover, evenly spaced.

Please note, further information in this booklet may be from generic instructions. However, the principal is always the same.

Installing the Liner-Lock



Liner-lock is a plastic extrusion that is used to secure the pool liner. This needs to be fitted to the inside of the pool around the entire perimeter. When cutting the Liner-lock cut it at either 45 degrees to fit the corners of the pool or 90 degrees. Other than aesthetics it makes no difference, as when the liner and Liner-lock wedge is installed you cannot see the Liner-lock. You can use a chop saw, panel saw or hack saw to do this. It is important that where the Liner-lock joins you make sure it is lined up at the groove to accept the liner running continuously, without any misalignment. As you can see in this photo the join runs with the groove completely in line.

Pre-drill the Liner-lock every 300mm with a 3mm drill bit, as this will ensure inserting the screws is much easier and prevent any injury from slipping with the drill when you are starting the screw.



Use the 3.5mm x 40mm screws provided to fix the Liner-lock all the way around the pool. Where the strap system bolt is on the inside of the pool, fix a screw either side of the bolt to prevent the Liner-lock bowing over the bolt.

Fitting Inlets/Low-Level Suction or Vacuum Point



When installing an Inlet or Low-level suction (number of Inlets/Low level Suctions and Vac - point dependant on model) you will notice a flower shaped recess on the inside of the pool where these fittings are located.



Insert the back part of the fitting and screw it to the wall using the 3.5mm x 20mm screws provided as shown. Keep the other parts and gaskets somewhere safe for later. Make sure you have screw holes in the 12 and 6 o'clock positions.



At this stage, you can carefully stick one gasket on to the face of the fitting as shown, ensuring you line up the holes correctly when applying the gasket. Insert one screw, top and bottom (do not fully tighten) with the cross in the screws facing North, East, South and West (N,E,S,W). This makes it easier when having to find the screw heads underneath the liner. The same instruction applies to all pool fittings in the walls, round fittings are done like this and rectangular fittings such as skimmers would have a screw in each corner.

Laying the felt Underlay



If there are any protruding fixings or sharp splinters inside the pool at this point, use a piece of underlay tape to cover them up. Do not use any other tape other than the underlay tape supplied.



Before laying the felt floor you may want to lay some self-levelling screed to the thickness of the stainless-steel strap. This will ensure you cannot see the strap once the liner is installed. We would also suggest using a product such as Rotabond to stick the strap to the floor prior to using a screed to ensure the strap stays flat. The other option is that you will see the strap but again stick it flat to a clean floor using the Rotabond.



Avoid joining edges together which have been cut on site. Always try and tape two machined edges together. Only use the tape provided, never use any other type of tape. Use a pair of sharp scissors to cut the felt, never use a knife. Make sure the felt does not overlap as this will show through the liner.



Finally, trim the perimeter of the pool by using the back edge of the scissors to score the felt between the pool floor and wall. This leaves a line in the felt that you can cut neatly along with a sharp pair of scissors.

Foam Wall Protection



Locate the foam and spray adhesive. Start in one corner of the pool. Spray the adhesive on about 2-3 metres of wall section. Start unrolling the foam from that corner of the pool, pressing it firmly against the area of wall that you have just sprayed and work your way around the pool repeatedly. You can seal a join in the foam by using the underlay tape provided.



Pay particular attention to pressing the foam firmly into the corners and under the Liner-lock of the pool. Avoid getting adhesive on any fittings such as the inlets or skimmer. Trim around the perimeter of the pool by running a sharp pair of scissors directly under the Liner-lock. Cut the foam away neatly around any pool fittings.



Finally, seal any joins with the underlay tape provided.

Installing the Liner



It is essential that shoes are removed for the next stage. Ensure you have read the Recommendations for Storage section at the front of this booklet and have kept your liner in a warm environment. If you haven't, we strongly recommend you do until the liner feels relatively warm and supple. A cold liner is much harder to install and you may not be able to remove any creases. Before installing, make sure any fittings such as inlets, skimmers and lights have gaskets in place and screws in the N, E, S, W positions as explained previously.



Image from different pool to show example

Unfold the liner and lay it to suit the shape of the floor. At one position on the wall of the liner, there is a welded seam. Ensure this doesn't run through with a skimmer. If it does, rotate the liner. Once unfolded, line up the floor corners of the liner with the floor corners of the pool structure.



Image from different pool to show example

Note: the pool liner will have been made smaller than the structure as the weight of the water stretches it into position.



Image from different pool to show example

Starting at a corner take one of the walls and feed it into the liner-lock. When you release it, the weight of the liner holds it in position.



Image from different pool to show example

Carefully work your way around the pool, paying attention to the corners to sure they line up correctly.



Image from different pool to show example

Use your feet to gently push the corners of the pool liner into place.



Image from different pool to show example

If the liner is not quite lined up, you can unhook it and straighten it so that it is lined up perfectly.



Image from different pool to show example

On larger pools, use underlay tape to completely seal the fittings on the pool such as skimmers, inlets and lights. The idea is to make the pool structure as air tight as possible.



Image from different pool to show example

Using a vacuum cleaner with just the hose attached, peel back a small section of liner, and insert the hose as far down to the pool floor as possible. Make sure nothing can get stuck behind the liner. Reattach as much liner as possible around the hose. Then use the underlay tape to seal around the hose. Turn on the vacuum to help you.



Image from different pool to show example

Start removing any creases by systematically pushing them away from the centre of the pool floor towards the walls.

If you have any main drains (optional) be very careful not to tread on them.

Continue adjusting the liner and removing as many creases as possible.



Image from different pool to show example

When you are happy with the position of the liner you can install the Liner-lock wedge. The wedge goes above the liner into the Liner-lock channel. This locks the liner in place. Start in a corner working your way around the pool pressing it firmly into place. When you reach a corner, measure it precisely and cut the Liner-lock wedge to length. Alternately, you can cut a simple 'V' shape out of the back of the Liner-lock wedge. Get somebody to cut it standing away from the liner to prevent any accidents or damage to the liner. Carry on working your way around the pool cutting the Liner-lock wedge to length as required.



Image from different pool to show example

You can now start filling the pool with water. Continue to push any creases out of the floor by sliding your foot from the middle of the floor towards the pool walls.

Any stubborn minor creases that are left may be packing creases and should come out when the pool is filled and the water heated.



Image from different pool to show example

If you have main drains installed, turn the water off after filling the pool with approximately 25mm of water.

Take extreme care whilst using a Stanley knife in a pool. Have somebody outside the pool who can hand you tools. Carefully feel for the head of the two screws under the liner. Remember you should have left the cross of the screw in the North, East South and West positions. Make a tiny cut in the “cross” of the screw head. Then gently tease the screw head through the small incision you have made.



Image from different pool to show example

You should have exposed the screw head, now carefully expose the other screw on the opposite side to the one you have just done. Once you have exposed both screw heads you need the face plate for the drain. Carefully apply the gasket to the face plate.

Remove one of the screws you have exposed (using a hand-held screwdriver) and insert the screw through the face plate back into the hole and start to tighten screw. Then swing the face plate to the correct position and remove and insert the second screw.



Image from different pool to show example

You can now fit the rest of the screws as the face plate gives the position of the remaining screws.

With a large circle gasket always insert one screw and then insert the screw on the opposite side, working your way around the gasket until all screws are tightened evenly.

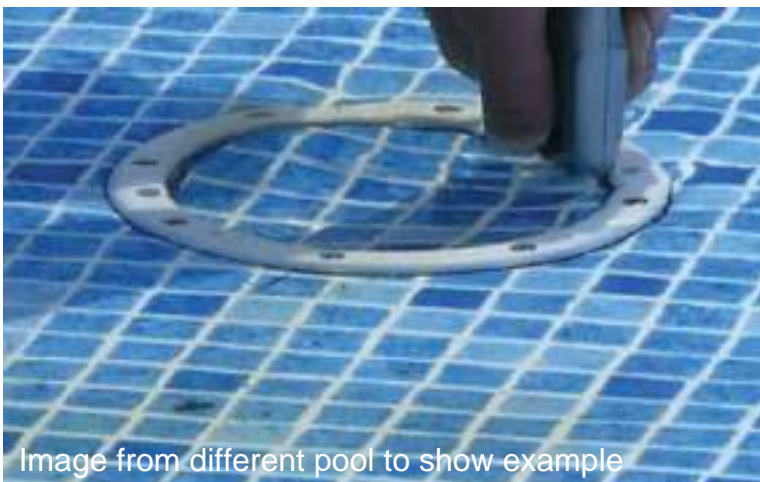

Image from different pool to show example

Assuming the pipe work for the main drains has had a ball-valve connected and the main drain face plate secured, you can carefully remove the liner material within the gasket with a sharp knife.



Image from different pool to show example

Repeat the whole process for the second main drain.



Image from different pool to show example

Now you can screw the main drain cover plate into place.



Image from different pool to show example

Before the water level reaches 50mm below the low-level suction/inlets you need to make the pool watertight. Start by using the PTFE tape provided. Use plenty of tape on the socket nipples to create a good watertight seal.



Image from different pool to show example

Screw the socket nipple into the back of the low-level suction/ inlets.



Ensure when you glue pipe work that you use the pipe cleaner supplied just before applying glue to both the fitting and pipe.

It is sometimes a good idea to dry fit pipe work before gluing. This way you can be sure your layout is to your satisfaction before gluing.

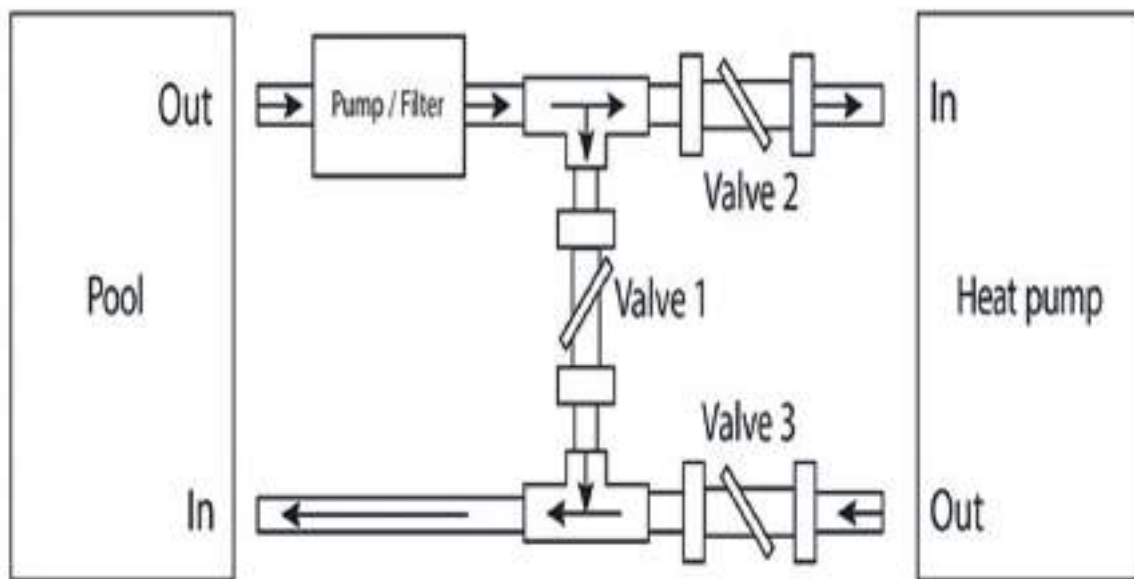

Before cutting in the fittings on the liner, plumb up any filtration equipment or counter current pipework to be installed. There is no specific diagram saying where each individual pipe fitting goes. However, as the diagram shows above, the principal is installing draining fittings from the pool such as skimmers, drains, low level suction or vac points. All of these should be on the “out” side of the pool going to the pump and filter. Any heat source should be plumbed in after a pump/filter before the returning to the pool. This system shows a bypass system with the use of valves so the heat source can be isolated or serviced.

Also, please be aware if you have a counter current/swim-jet system this would be an entirely separate pipework system.

Installing the Pipework and Equipment

To keep your swimming pool clear and hygienic you need to use a filtration system alongside chemicals, refer to the Wooden Pool Operating and Maintenance Manual.

The simplistic view is water needs to go the pump first via skimmer/s, low-level suction or main drains. It is then pushed through the filter which can contain either sand or glass media where the dirt is trapped. It can then return to the pool through the inlet fittings via a heater or heat pump (optional).

The valves and pipe work should be arranged so that it is impossible to have all the flow through the low-level suction. The high flow rate through one fitting could create an entrapment hazard which must be avoided.



Unpack the filter pump and position it before filling it with sand, it will be much easier to move whilst empty. Any electrical item must be at least 2 metres away from the pool unless enclosed by a filtration enclosure. We recommend enclosing the plant equipment for longevity.

The model of filter pump may vary depending on product purchased. Always read the manufacturer's instructions on how to assemble the product. Fill the filter with sand according to the instructions.



If you have an optional heater, assemble it after the filter pump according to the manufacturer's instructions.

The pipe work kit which is supplied is generous and there can be variations in fitting. It will only include fittings for filtration. If a heater or other piece of equipment is purchased, additional pipework will be needed.



Run your pipe work as neatly as possible. Where possible, install all pipe and fittings so they are resting on the ground. Trial fit all pipe and fittings without cleaner or glue, this "dry fitting" will save time in the long run and allow you to check work before committing to gluing.

Cut all pipework to 90 degrees, and remove any burs. Trial fit the pipe(s) and fitting(s) "dry fit".

Use pipe cleaner on both pipe and fittings, this removes any dirty or grease on the fittings and helps with adhesion of the glue. Give both the pipe and fitting a good coverage of glue and push together until set. On warm days, you may have to work fast, as the glue can set quickly.

Installing Low Level Suctions / Inlets



Next, you need to cut in the low-level suction/ inlet fittings. It's useful to have somebody outside the pool to hand you tools. The pool needs to be filled to approximately 50mm below the fittings. Feel for the screw heads with your fingers. Very carefully make an incision into the 'cross' of the screw head, remember the cross of the screw head is in the N, E, S, W position. Once you have made the incisions, gently push the screw heads through the liner, ensuring the holes are as small as possible.



One gasket is on the fitting behind the liner, you now need to fit a gasket on the face plate ensuring the holes line up. Once you have done this, remove the top screw that is exposed. Insert the screw through the face plate back into the small hole you have made in the liner. Now remove the bottom screw and let the face plate swing into position. You can now insert the second screw through the face plate and second screw hole you have made.



Always use a hand-held screwdriver. Gently tighten the screws and fit the other two screws. Cut out the liner material within the face plate.

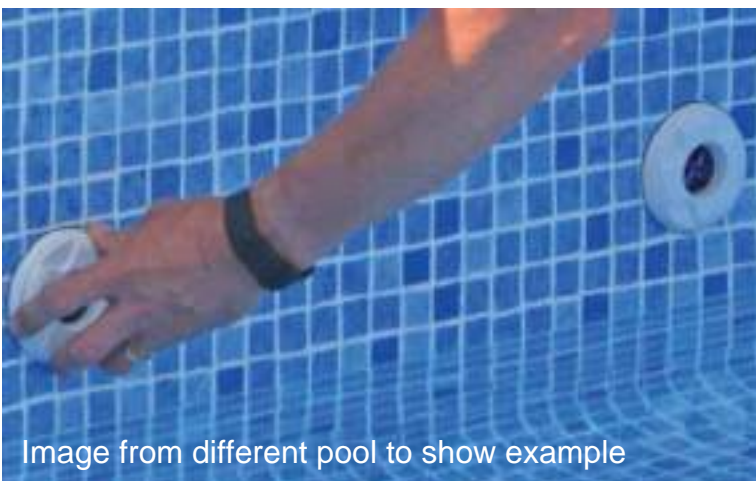

Finally, screw in the eyeball/ fixed grate or vac-point fitting.

Installing the Skimmer(s)



Installing the skimmer is the same method as all the other pool fittings, you should already have one gasket fitted to the skimmer behind the liner and the screws are in the four corners of the skimmer. When the water level is just below the skimmer carefully insert a small cut in the 'cross' of the screw heads, and gently push the screw head through the liner.

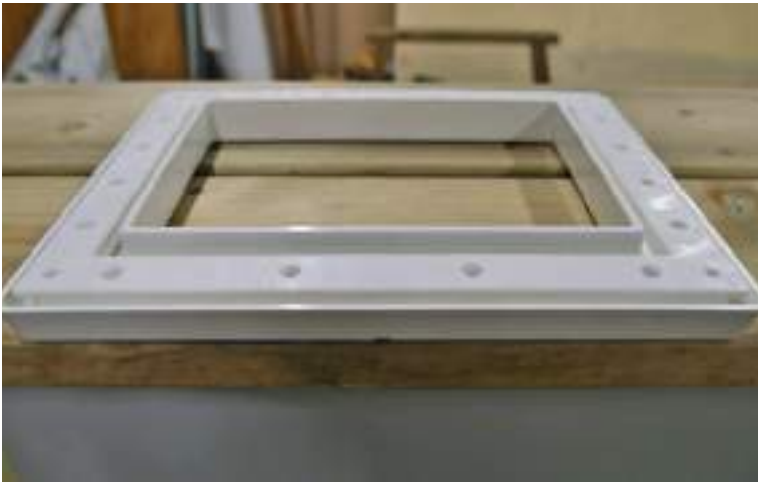

Apply the gasket carefully to the skimmer faceplate ensuring the holes line up.



Undo a top corner screw and insert it through the faceplate and back through the small hole you created. Swing the skimmer up and do the same for the other top corner.

You can now undo the bottom two screws and screw them back through the face plate into the small holes you made. Gently tighten the four screws.

Now insert the rest of the screws. Try and do it systematically, working from the middle of the skimmer, top and bottom. Work your way to the outer edges ensuring all the screws are tightened.



Insert the faceplate cover.



Carefully cut the liner from the inside of the skimmer with a sharp knife.

Installing the Stainless Steel Ladder



Assemble the stainless steel ladder according to the instructions supplied with the ladder.



Put the pots, which come with the ladder, on. Line up the stainless steel ladder in line with the inside of the wooden ladder so as to give you enough room for fixing the bolts under the top shelving.



Carefully mark around the stainless steel pots with a pencil, ensure your ladder is in the correct position. It should have the feet of the ladder resting against the inside of the pool wall, and remain vertical and straight before marking the hole positions.



With the Hole Saw provided with the ladder, drill out the holes you've marked for the ladder pots.



Insert the ladder in the pots and ensure it fits its final position, mark the holes for the bolts



Drill the bolt holes for the ladders pots with an 8mm drill bit.



Insert bolts using the washers and nuts provided and tighten in place. This completes the ladder which is now a removable ladder.

The pool is now complete.

Tools List

- Tape Measure
- Spirit Level
- Various Digging And Concreting Tools
- Socket set
- Heavy mallets
- Cordless drill driver
- Selection of driver bits
- 3mm, 4mm and 5mm drill bits
- Hand saw or chop saw (if available)
- Set Square
- Pencil
- Sharp scissors
- Hand-held screwdriver
- Sharp knife
- Hammer
- Sharp chisel
- Sand paper
- 85mm hole cutter (light installation only)
- Wet and dry vacuum cleaner
- Goggles/glasses and Protective gloves



Wooden Pool Warranty

Plastica give a 10 year parts only warranty to the timber structure against wood rot and insect infestation

Timber Structure	10 years
Liner	5 years
Top Deck	1 year
Pump	1 year
Filter	1 year

Terms of Warranty on Wooden Pool Structure:

The warranty duration on the wooden pool structure is 10 years on a pro-rata basis, reducing by 10% per annum. eg. after 3 years the warranty covers 70% of any valid claim.

The warranty covers the 44mm timber structure from insect attack and rotting. This applies to the damaged wall planks only, providing they are returned to our St Leonards factory at the consumers cost and risk. Any replacements will be arranged in accordance with the above warranty with free of charge delivery back to site (UK mainland only).

Terms of Warranty:

- 1. We will need to see the original proof of purchase.*
- 2. The pool must be installed in accordance with the installation instructions and remain in its original installation location.*
- 3. Wood is a natural product and movement and discolouration can be expected. Plastica Ltd accept no liability for any such issues that may arise.*
- 4. This warranty is between Plastica Ltd and the original purchaser and is not transferable.*
- 5. Plastica Ltd accepts no liability for any consequential loss.*

Structure Warranty

0 to 12 months	100%
13 to 24 months	90%
25 to 36 months	80%
37 to 48 months	70%
49 to 60 months	60%
61 to 72 months	50%
73 to 84 months	40%
85 to 96 months	30%
97 to 108 months	20%
109 to 120 months	10%

Liner Warranty

0 to 12 months	100%
13 to 24 months	80%
25 to 36 months	60%
37 to 48 months	40%
49 to 60 months	20%

Notes

Notes

Notes



The UK's Leading Independent Swimming Pool Manufacturer and Distributor

 www.woodenpools.net

 sales@woodenpools.net

Find us on     