

# Anti-Theft Mount For Google Nest Cam (battery)

USER MANUAL



W  
WASSERSTEIN



## In the Box

- 1 x anti-theft mount
- 2 x screws to lock the anti-theft mount
- 1 x security chain
- 1 x torx screwdriver
- 1 x user manual



anti-theft mount



security chain



screws to lock the anti-theft mount



torx screwdriver

## Pre-Installation

- Peel the plastic protection layers away from the silicone holders inside the Anti-Theft Mount.

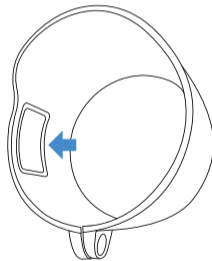

## Installation

1. Unscrew the magnetic mount of your camera if you have previously installed it on your wall.

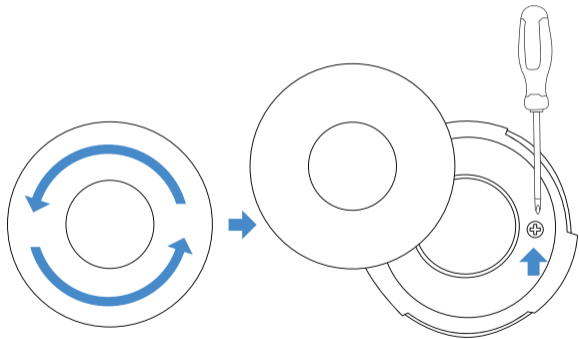

2. Place the security chain (the bottom end with the big hole) underneath the magnetic plate of the camera behind the screw hole.

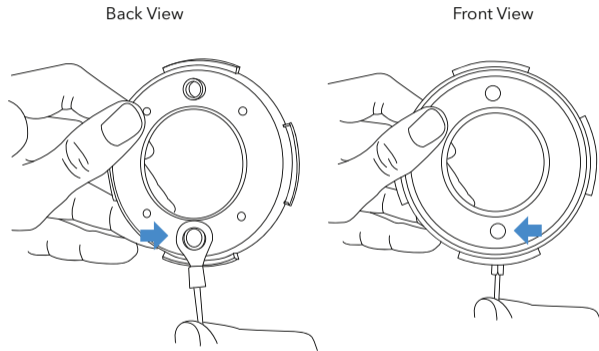

3. Making sure the holes of the security chain and magnetic plate are aligned, mount the magnetic mount to the wall.

**Note:** Make sure that the security chain is underneath the plate. The security chain touches the wall first and then the plate.

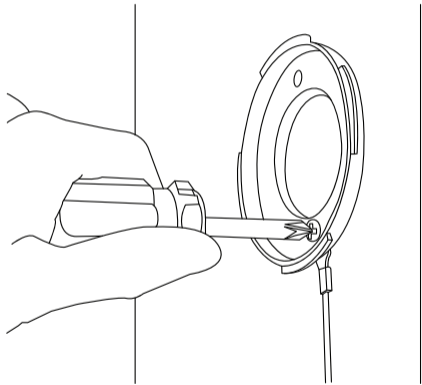

4. Attach the magnetic cover onto the mount and turn it clockwise.

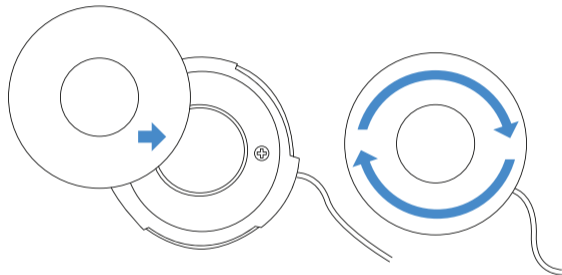

5. Slide in the Anti-Theft Mount onto the camera. Ensure that the speaker/charging port openings at the bottom are aligned.

**Note:** The screw holes of the Anti-Theft Mount should be towards the front of the camera.

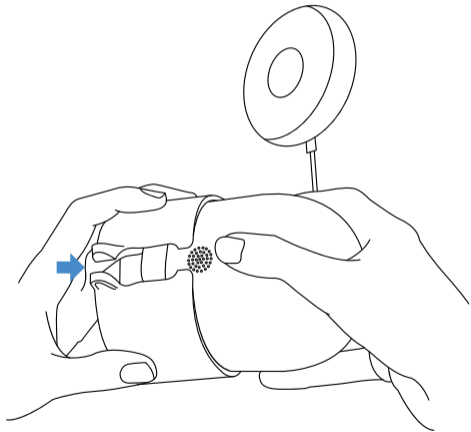

6. Make sure that the end of the security chain with the small hole goes in between the screw holes of the mount. Use the torx screwdriver to tighten the mount from the right side and lock the security chain.

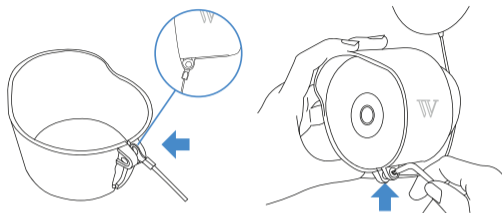

7. Attach your Nest Cam to the magnetic mount.

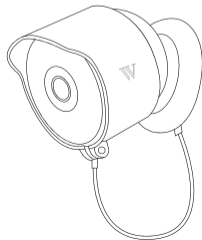

# Get More Support

Scan the QR code below or, email us at  
[contact@wasserstein-home.com](mailto:contact@wasserstein-home.com)



The Wasserstein Anti-Theft Mount has been certified by Wasserstein to meet Google's compatibility standards. Google is not responsible for the operation of this product or its compliance with any applicable safety or other requirements.

Learn more at [g.co/madeforgoogle](http://g.co/madeforgoogle).

Google's "made for" badge, Google Nest Cam (battery), and related marks are trademarks of Google LLC.

Google Nest Cam (battery) is not included.  
Wasserstein is not affiliated with Google LLC.  
Wasserstein is a trademark of Dropcases Ltd.  
Google Nest Cam (battery) is a trademark of Google LLC.

A large, serif, grey letter 'W' centered above the brand name.

WASSERSTEIN

For more information, please visit:  
[www.wasserstein-home.com](http://www.wasserstein-home.com)  
or contact us at:  
[contact@wasserstein-home.com](mailto:contact@wasserstein-home.com)  
Made in China

# Soporte Antirrobo Para Anti-Theft Mount For Google Nest Cam (battery)

MANUAL DE USUARIO



W  
WASSERSTEIN



## En la Caja

- 1 x soporte antirrobo
- 2 x tornillos para bloquear el soporte antirrobo
- 1 x cadena de seguridad
- 1 x destornillador torx
- 1 x manual de usuario



soporte antirrobo



cadena de seguridad



tornillos para bloquear el soporte antirrobo



destornillador torx

## Preinstalación

- Despega las capas de protección de plástico de los soportes de silicona del interior del Soporte Antirrobo.

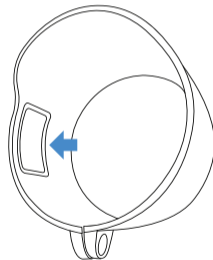



## Instalación

1. Desenrosca el soporte magnético de tu cámara si lo has instalado previamente en la pared.

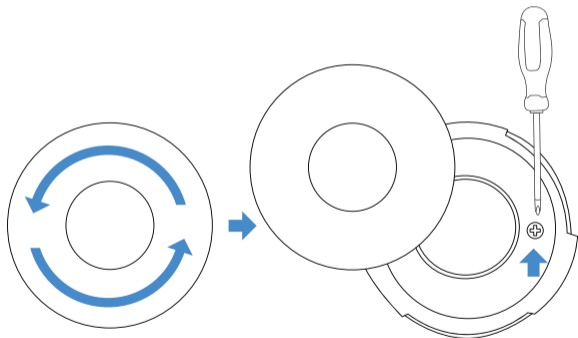

2. Coloca la cadena de seguridad (el extremo inferior con el agujero grande) debajo de la placa magnética de la cámara, detrás del agujero del tornillo.

Vista trasera

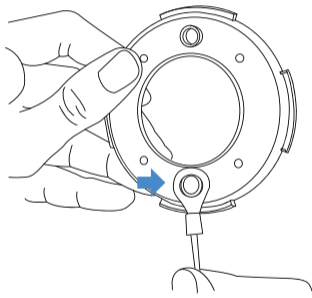

Vista frontal

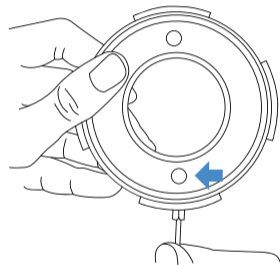

3. Asegurándote de que los agujeros de la cadena de seguridad y la placa magnética están alineados, monta el soporte magnético en la pared.

**Nota:** Asegúrate de que la cadena de seguridad esté debajo de la placa. La cadena de seguridad debe tocar primero la pared y luego la placa.

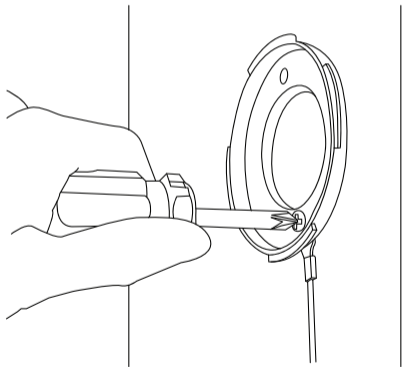

4. Coloca la cubierta magnética en el soporte y gírala en el sentido de las agujas del reloj.

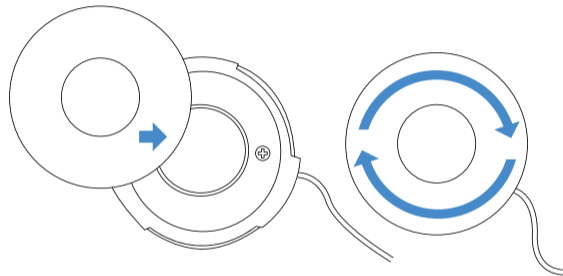

5. Desliza el Soporte Antirrobo en la cámara. Asegúrate de que las aberturas del altavoz y del puerto de carga de la parte inferior estén alineadas.

**Nota:** Los agujeros de los tornillos del Soporte Antirrobo deben estar hacia la parte delantera de la cámara.

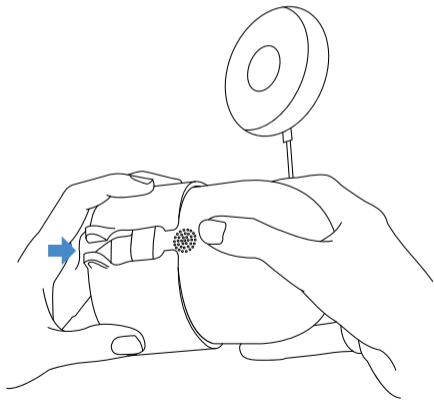

6. Asegúrate de que el extremo de la cadena de seguridad con el orificio pequeño entra entre los orificios de los tornillos del soporte. Utiliza el destornillador Torx para ajustar el soporte desde el lado derecho y bloquear la cadena de seguridad.

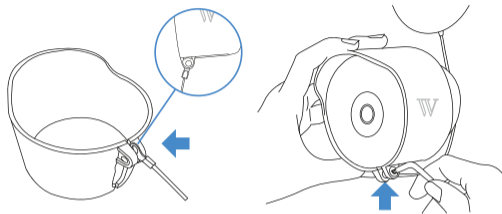

7. Coloca tu Nest Cam en el soporte magnético.

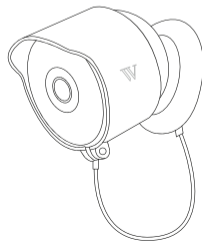

# Obtenga más apoyo

Escanee el código QR que aparece a continuación o envíenos un correo electrónico a [contact@wasserstein-home.com](mailto:contact@wasserstein-home.com)



El Soporte Antirrobo de Wasserstein ha sido certificado por Wasserstein para cumplir con los estándares de compatibilidad de Google. Google no se hace responsable del funcionamiento de este producto ni de su cumplimiento con los requisitos de seguridad u otros aplicables.

Más información en [g.co/madeforgoogle](http://g.co/madeforgoogle).

El distintivo "made for" de Google, Google Nest Cam (battery) y las marcas relacionadas son marcas comerciales de Google LLC.

Google Nest Cam (battery) no está incluido.  
Wasserstein no está afiliado a Google LLC.  
Wasserstein es una marca comercial de Dropcases Ltd.  
Google Nest Cam (battery) es una marca comercial de Google LLC.

W  
WASSERSTEIN

Para más información, visita:  
[www.wasserstein-home.com](http://www.wasserstein-home.com)  
o contacta con nosotros en:  
[contact@wasserstein-home.com](mailto:contact@wasserstein-home.com)  
Made in China

# Support antiviol pour Google Nest Cam (batterie)

GUIDE D'UTILISATION



W  
WASSERSTEIN



## Inclus dans la boîte

- 1 x support antiviol
- 2 x vis pour verrouiller le support antiviol
- 1 x chaîne de sécurité
- 1 x tournevis torx
- 1 x guide d'utilisation



support antiviol



chaîne de sécurité



vis pour verrouiller  
le support antiviol



tournevis torx

## Pré-installation

- Retirez les couches de protection en plastique des supports en silicone à l'intérieur du support antiviol.

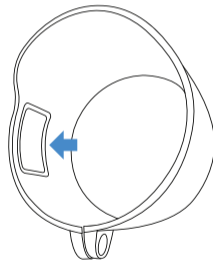

## Installation

1. Dévissez la plaque magnétique de votre caméra si vous l'avez préalablement installée sur votre mur.

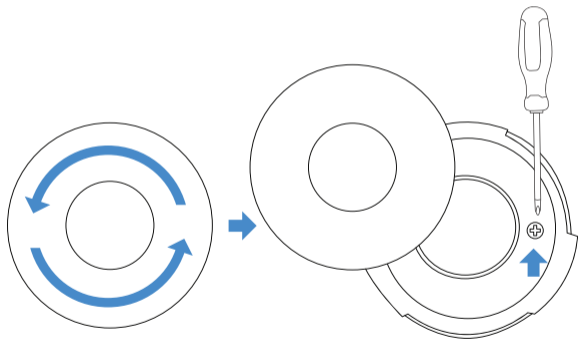

2. Placez la chaîne de sécurité (l'extrémité inférieure avec le gros trou) sous la plaque magnétique de la caméra, derrière le trou de vis.

Vue arrière

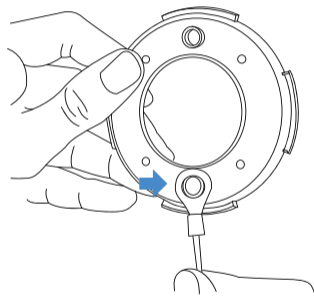

Vue de face

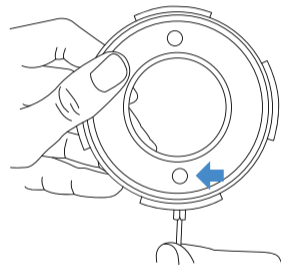

3. En vous assurant que les trous de la chaîne de sécurité et de la plaque magnétique sont alignés, fixez le support magnétique au mur.

**Note:** Assurez-vous que la chaîne de sécurité se trouve sous la plaque. La chaîne de sécurité doit d'abord toucher le mur, puis la plaque.

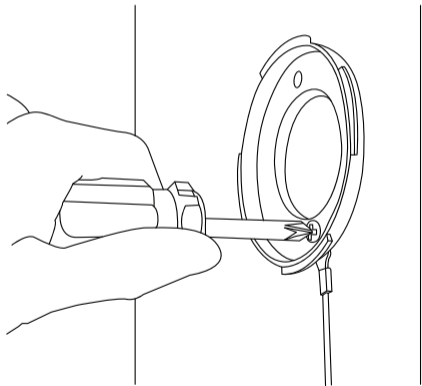

4. Fixez le couvercle magnétique sur le support et tournez-le dans le sens des aiguilles d'une montre.

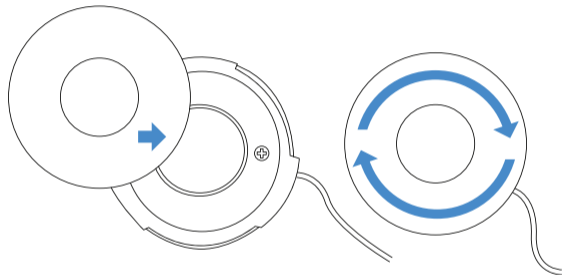



5. Faites glisser le support antivol sur l'appareil. Assurez-vous que les ouvertures du haut-parleur / du port de chargement bas sont alignées.

**Note:** les trous de vis du support antivol doivent être orientés vers l'avant de la caméra.

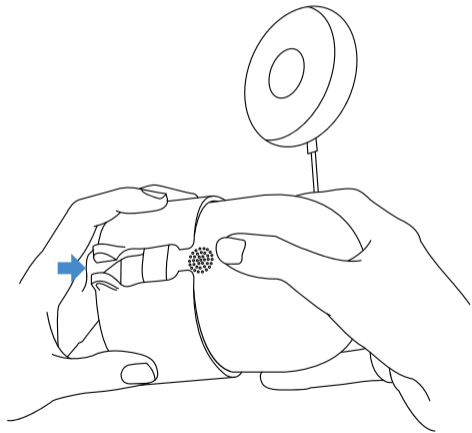

6. Assurez-vous que l'extrémité de la chaîne de sécurité avec le petit trou passe entre les trous de vis du support. Utilisez le tournevis torx pour serrer le support du côté droit et verrouiller la chaîne de sécurité.

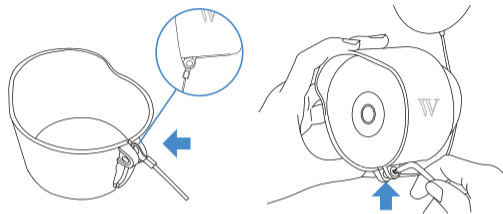

7. Fixez votre Nest Cam sur le support magnétique.

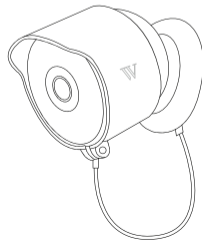

# Bénéficiez de notre support

Scannez le code QR ci-dessous ou adressez-nous  
un email à [contact@wasserstein-home.com](mailto:contact@wasserstein-home.com)



Le support antivol Wasserstein a été certifié par Wasserstein pour répondre aux normes de compatibilité de Google. Google n'est pas responsable du fonctionnement de ce produit ou de sa conformité à toute exigence de sécurité ou autre loi applicable.

Pour en savoir plus, rendez-vous sur [g.co/madeforgoogle](https://g.co/madeforgoogle).

Le badge ""made for"" de Google, Google Nest Cam (battery) et les marques associées sont des marques commerciales de Google LLC.

Le Google Nest Cam (battery) n'est pas inclus.  
Wasserstein n'est pas affilié à Google LLC.  
Wasserstein est une marque de Dropcases Ltd.  
Google Nest Cam (battery) est une marque de commerce de Google LLC.

**W**  
**WASSERSTEIN**

Pour plus d'informations, veuillez consulter le site  
**[www.wasserstein-home.com](http://www.wasserstein-home.com)**  
ou nous contacter à l'adresse suivante  
**[contact@wasserstein-home.com](mailto:contact@wasserstein-home.com)**  
Fabriqué en Chine

# Anti-Diebstahl-Halterung für Google Nest Cam (battery)

BENUTZERHANDBUCH



W  
WASSERSTEIN



made for  
Google

## Paket enthält

- 1 x anti-diebstahl-halterung
- 2 x schrauben zum Sichern der anti-diebstahl-halterung
- 1 x sicherheitskette
- 1 x torx-schraubenzieher
- 1 x benutzerhandbuch



anti-diebstahl-halterung



sicherheitskette



schrauben zum sichern der anti-diebstahl-halterung



torx-schraubenzieher

## Vorinstallation

- Ziehen Sie die Kunststofffolien von den Silikonhaltern im Inneren der Anti-Diebstahl-Halterung ab.

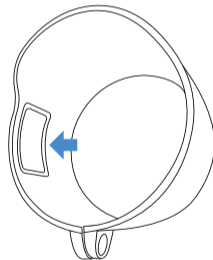

## Einbau

1. Schrauben Sie die Magnethalterung Ihrer Kamera ab, falls Sie diese bereits an der Wand montiert haben.

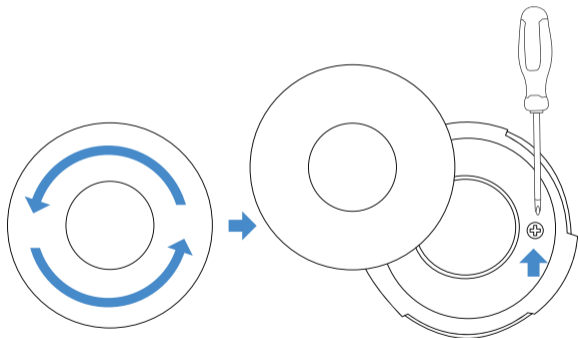

2. Halten Sie die Sicherheitskette (das untere Ende mit dem großen Loch) unter die Magnetplatte der Kamera hinter das Schraubloch.

Rückansicht

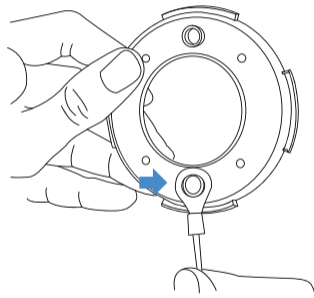

Vorderansicht

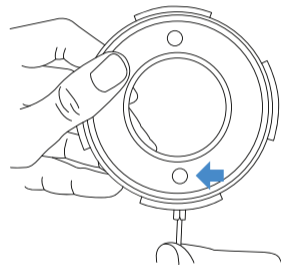

3. Achten Sie darauf, dass die Löcher der Sicherheitskette und der Magnetplatte in eine Linie gebracht sind und befestigen Sie die Magnethalterung an der Wand.

**Hinweis:** Achten Sie darauf, dass die Sicherheitskette unterhalb der Platte liegt. Die Sicherheitskette sollte zuerst die Wand und dann die Platte berühren.

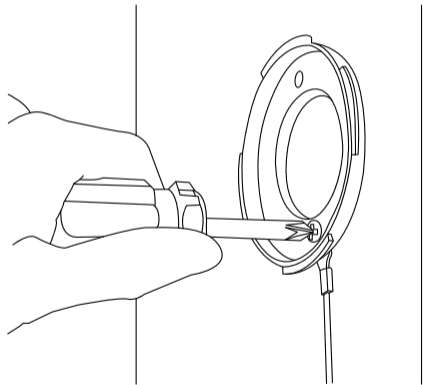

4. Bringen Sie die Magnetabdeckung an der Halterung an und drehen Sie sie im Uhrzeigersinn.

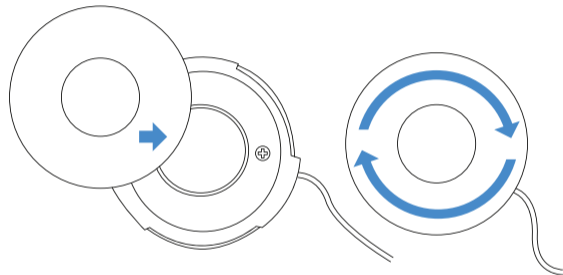

5. Schieben Sie die Anti-Diebstahl-Halterung auf die Kamera. Achten Sie darauf, dass die Öffnungen für den Lautsprecher/Ladeanschluss an der Unterseite an der richtigen Stelle sind.

**Hinweis:** Die Schraubenlöcher der Anti-Diebstahl-Halterung sollten in Richtung der Vorderseite der Kamera zeigen.

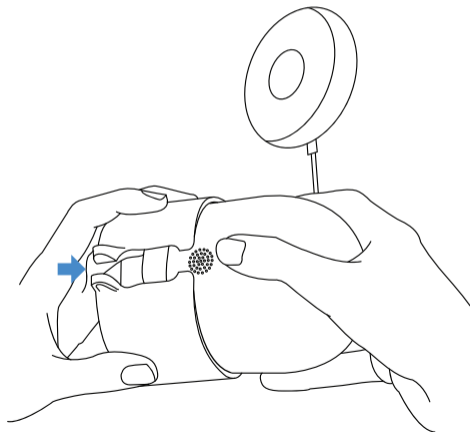

6. Achten Sie darauf, dass das Ende der Sicherheitskette mit dem kleinen Loch zwischen die Schraublöcher der Halterung passt. Verwenden Sie den Torx-Schraubenzieher, um die Halterung von der rechten Seite aus festzuziehen und die Sicherheitskette zu verriegeln.

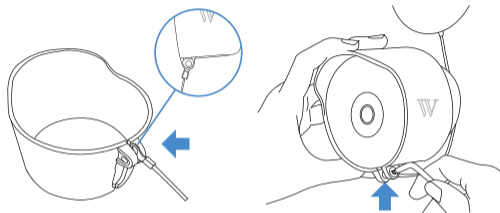

7. Bringen Sie Ihren Nest Cam an der Magnethalterung an.

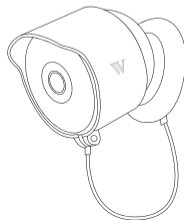

# Für mehr Unterstützung

Scannen Sie den QR-Code unten oder senden Sie uns eine E-Mail an [contact@wasserstein-home.com](mailto:contact@wasserstein-home.com)



Die Wasserstein Anti-Diebstahl-Halterung wurde von Wasserstein zertifiziert, um die Kompatibilitätsstandards von Google zu erfüllen. Google ist nicht verantwortlich für die Nutzung dieses Produkts oder dessen Konformität mit geltenden Sicherheits- oder anderen Anforderungen.

Erfahren Sie mehr unter [g.co/madeforgoogle](http://g.co/madeforgoogle).

Das "Made for"-Zeichen von Google, Google Nest Cam (battery) und verwandte Marken sind Marken von Google LLC.

Google Nest Cam (battery) ist nicht enthalten.  
Wasserstein gehört nicht zu Google LLC.  
Wasserstein ist eine Marke von Dropcases Ltd.  
Google Nest Cam (battery) ist eine Marke von Google LLC.

W  
WASSERSTEIN

Für weitere Informationen besuchen Sie bitte:  
**[www.wasserstein-home.com](http://www.wasserstein-home.com)**  
oder kontaktieren Sie uns unter:  
**[contact@wasserstein-home.com](mailto:contact@wasserstein-home.com)**  
Hergestellt in China