

LTRS SERIES Commercial Lighting

LTRS-2X2-MCTP LED STACK TROFFER

MCTP Multi Color Temperature & Multi Power/Wattage (Selectable)
NO PARTIAL. MUST BUY IN MASTER PKG. QTY. - 1-Minute field-assembly required



Customer Name: _____

Project Name: _____

Note: _____ Type: _____

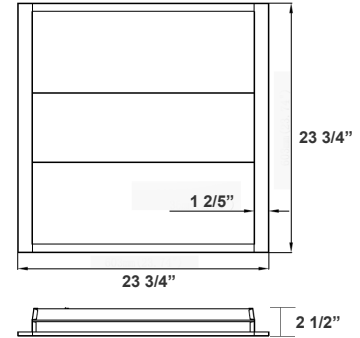

23 3/4"(L) x 23 3/4"(W) x 2 1/2"(H)

This Troffer Light is ideal for Hotels, Offices, Retail Outlets, Restaurants, Storage Rooms, Conference Rooms, Education Facilities, and more.

Features

- White Finish
- Rated Life: 50,000 Hours
- NO PARTIAL. MUST BUY IN MASTER PKG. QTY.
- 1-Minute Field-Assembly Required
- Lens: Polycarbonate
- Multi CCT & Power (Selectable Switch Under The Lens)
- 5-Year Warranty

Technical Specifications

Electrical:

- Voltage: 120-277VAC 50/60Hz
- Wattage: 25W/35W/36W/40W
- Power Factor: >0.97
- Efficacy: 125 LPW

Mechanical:

- White Finish
- Cold-Rolled Steel, 2.6" thickness
- Driver Box & Lens are separate. field-assembly required
- Earthquake Hooks Built into the Housing
- Operating Temperature: -4°F ~ 122°F
- 5-Year Warranty

Lighting:

- Multi CCT & Multi Power (Selectable Switch Under The Lens)
- Dimmable: 0~10V Dimming
- Total Lumens: 3125LM/4375LM/4500LM/5000LM
- Color Temperatures: 3500K/4000K/5000K
- Color Rendering Index: CRI ≥ 80
- Lifespan: 50,000 hrs

Applications:

- This LED Center Basket Troffer Light is ideal for Hotels, Offices, Retail Outlets, Restaurants, Storage

Other Models:

- 40W | 5000LM | LTRS-1X4-MCTP
- 50W | 6250LM | LTRS-2X4-MCTP



Photometrics: LTRS-2X2-MCTP

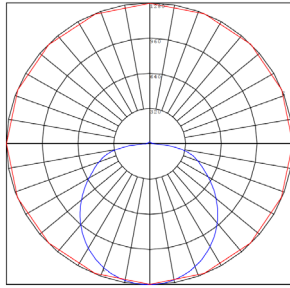
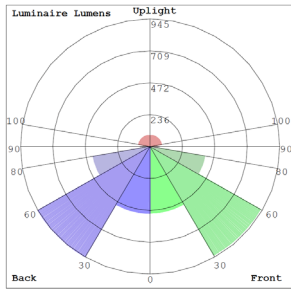

BUG Rating: B1-U3-G1

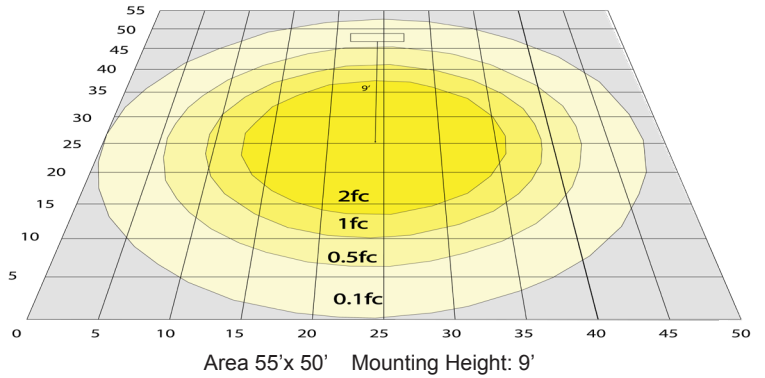

Other Views:



Side View

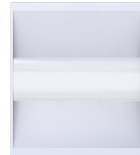

Front View

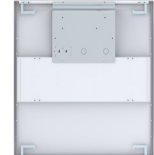

Back View

Performance Table: LTRS-2X2-MCTP

MODEL NO.	Wattage	Voltage	Lumens	Color Temp.	BUG Rating	LPW
LTRS-2X2-MCTP	25W 35W 36W 40W	120~277V	3125LM 4375LM 4500LM 5000LM	3500K 4000K 5000K	B1-U3-G1	125

Sample Ordering

Model Size Watt/Color Temp.

LTRS - 2X2 - MCTP

Accessories:

Blank = No Option For Accessories

ELB-20175-AC-FLEX = 20W MAX, 175VDC, Li-ion 4000mAh

Packaging Info:

	QTY	UOM	L (IN)	W (IN)	D (IN)	Weight (LBS)
Master Carton	6	Case	26.38	8.86	26.38	35.47

NO PARTIAL. MUST BUY IN MASTER PKG. QTY.

ACCESSORIES:



ELB-20175-AC-FLEX

Other Models: LTRS-2X4-MCTP



Side View

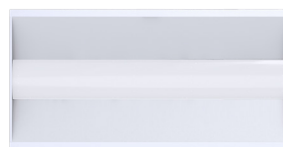

Front View



Back View