

TCL

2.1 Channel Sound Bar with Wireless Subwoofer

S522W



User Manual

Contents

1	Important safety instructions	1
	Important information	1
	Important safety instructions	3
	Battery Caution and Disposal Information	5
<hr/>		
2	Welcome	8
	What's in the box	8
	Overview	9
	Overview of the remote control	10
	Install/replace the remote control batteries	11
<hr/>		
3	Set up your Sound Bar system	13
	Position Your Sound Bar and Subwoofer	13
	Mount your Sound Bar on the wall	14
<hr/>		
4	Connect your Sound Bar system	17
	Connect with the AC power adaptor	17
	Connect with the HDMI cable	18
	Connect with the optical cable	19
	Direction for setting up your Sound Bar using an optical cable	20
	Connect with USB disk	20
<hr/>		
5	Use your Sound Bar system	21
	Operation instruction	21
	Volume and Sound effect regulation	23
<hr/>		
6	Specification	25
<hr/>		
7	Notice	26
	Declaration of conformity	26
	Disposal of your old product and battery	26
	Trademarks	28
<hr/>		
8	FAQ	29

1 Important safety instructions

Important information



CAUTION

**RISK OF ELECTRIC SHOCK
DO NOT OPEN!**



CAUTION: TO REDUCE THE RISK OF ELECTRIC SHOCK, DO NOT REMOVE COVER (OR BACK). NO USER SERVICEABLE PARTS INSIDE. REFER SERVICING TO QUALIFIED SERVICE PERSONNEL.



The lightning flash with arrowhead symbol, within an equilateral triangle is intended to alert the user to the presence of uninsulated dangerous voltage within the product's enclosure that may be of sufficient magnitude to constitute a risk of electric shock.



The exclamation point within an equilateral triangle is intended to alert the user to the presence of important operating and maintenance (servicing) instructions in the literature accompanying the product.

Warnings

- *To reduce the risk of fire or electric shock, do not expose this product to rain or moisture. This product should not be exposed to dripping or splashing. No objects filled with liquids, such as vases, should be placed on or near the product.*
- *The product is unstable if it is not properly placed or mounted to the wall. Be sure to follow the wall mounting instructions provided in this user manual or Quick start guide to ensure your safety.*
- *Do not expose batteries to excessive heat such as sunshine, fire, and so forth.*

Important safety instructions

- **Read these instructions** - Read all the safety and operating instructions before operating the product.
- **Retain these instructions** - Retain the safety and operating instructions for future reference.
- **Heed all warnings** - Adhere to all warnings on the product and in the operating instructions.
- **Follow all instructions** - Follow all operating and use instructions.
- **Do not use this apparatus near water** - The appliance should not be used near water or moisture - for example, in a wet basement or near a swimming pool and the like.
- **Clean only with a dry cloth.**
- **Do not block any ventilation openings.** Install in accordance with the manufacturer's instructions.
- **Do not install near any heat sources** such as radiators, heat registers, stoves, or other apparatus (including amplifiers) that produce heat.
- **Protect the power cord** from being walked on or pinched particularly at plugs, convenience receptacles, and the point where it exits from the product.

- **Use only attachments/accessories** specified by the manufacturer.



- **Use only with the cart**, stand, tripod, bracket, or table specified by the manufacturer, or sold with the apparatus. When a cart is used, use caution when moving the cart/apparatus combination to avoid injury from tip-over.



- **Unplug this apparatus** during lightning storms or when unused for long periods of time.
- **Refer all servicing** to qualified service personnel. Servicing is required when the apparatus has been damaged in any way, such as power-supply cord or plug damaged, liquid has been spilled or objects have fallen into the apparatus, the apparatus has been exposed to rain or moisture, does not operate normally, or has been dropped.

Cautions

- The product shall not be exposed to dripping or splashing.
- Do not place any sources of danger on the product (for example. liquid filled objects, lighted candles).

- Disconnect the power adapter to shut off when you find trouble or when not in use. The power adapter shall be easy to access.
- Use of controls or adjustments or performance of procedures other than those described herein, may result in hazardous radiation exposure or other unsafe operation.
- The power adapter/appliance coupler is used as the disconnect device, the disconnect device must remain readily accessible.
- Danger of explosion if battery is incorrectly replaced. Replace only with the same or equivalent type.
- No naked flame sources, such as lighted candles, should be placed on the apparatus.

Battery Caution and Disposal Information

- Do not ingest battery, Chemical Burn Hazard.
- Install only new batteries of the same type in your product.
- Failure to insert batteries in the correct polarity, as indicated in the battery compartment, may shorten the life of the batteries or cause batteries to leak.
- Do not dispose of batteries in fire, water or a hot oven, or mechanically crushing or cutting of a battery.
- Leaving a battery in an extremely high temperature surrounding environment that can result in an explosion or the leakage of flammable liquid or gas.

- A battery subjected to extremely low air pressure that may result in an explosion or the leakage of flammable liquid or gas.
- Recycle or dispose of batteries as per state and local guidelines.
- Danger of explosion if battery is incorrectly replaced. Replace only with the same or equivalent type.
- When the remote control is not to be used for a long time (more than a month), remove the battery from the remote control to prevent it from leaking.
- If the batteries leak, wipe away the leakage inside the battery compartment and replace the batteries with new ones.
- Keep away the batteries from heat or moisture.
- Do not carry or store batteries with other metallic objects.
- Doing so could cause batteries to short circuit, leak or explode.
- Never recharge a battery unless it is confirmed to be a rechargeable type.
- The product/remote control contains a coin/button type battery, which can be swallowed. Keep the battery out of reach of children at all times! If swallowed, the battery can cause serious injury or death. Severe internal burns can occur within two hours of ingestion.
- If you suspect that a battery has been swallowed or placed inside any part of the body, seek immediate medical attention.
- When you change the batteries, always keep all new and used batteries out of reach of children. Ensure that

the battery compartment is completely secure after you replace the battery.

- If the battery compartment cannot be completely secured, discontinue use of the product. Keep out of reach of children and contact the manufacturer.

Installation location

- This product is designed to sit on a firm, flat surface. Do not place the product on built-in installation such as a bookcase or rack because the ventilation slots around the product will be blocked, resulting in reduced lifetime from overheating. To assure adequate ventilation for this product, maintain a spacing of 20cm or more around the product.
- Make sure the product on the furniture is of adequate size and strength to prevent it from being accidentally tipped over, pushed off, or pulled off. This could cause personal injury and/or damage to the product.
- Installation of wall mount must be carried out by qualified personnel only. Incorrect assembly can result in severe personal injury and property damage (if you intend to install this product yourself, you must check for installations such as electrical wiring and plumbing that may be buried inside the wall). It is the installer's responsibility to verify that the wall will safely support the total load of the product and wall mount brackets.

2 Welcome

Congratulations on the purchase of your new TCL Sound Bar! After it is set up and connected, you can experience a super sound quality and state-of-the-art design to best fit your home entertainment system. You are recommended to read through this user manual which helps you set up, connect and operate the product easily and properly.

Let's get started.

What's in the box

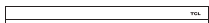

Sound Bar main unit



Wireless subwoofer



AC adaptor x 2



Remote control

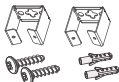

Wall anchor x 2
Wall mount bracket x 2
Wall bracket screw x 2



Warranty Card

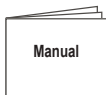

Manual



Wall Mount Template

Overview

Button and jack definition:

Buttons and jacks are defined as follows:

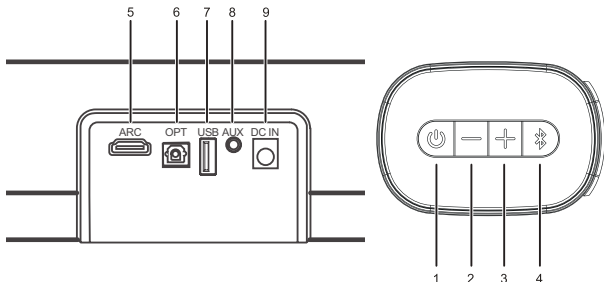

1. : Press to power on, short press to switch function, long press to power off
2. : Press for volume down
3. : Press for volume up
4. : Press for Bluetooth pairing
5. ARC: HDMI ARC
6. OPT: Optical input
7. USB: USB input
8. AUX: 3.5mm connector
9. DC IN: DC14V 2A input

Function indicator light:

1. Red light: In standby mode
2. White light: In operation

Overview of the Remote Control

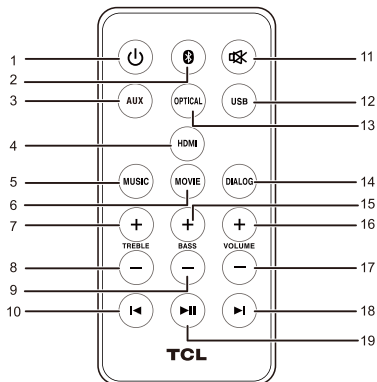

1. : Press to power on and power off.
2. : Press to switch to Bluetooth mode, long press to bluetooth pairing.
3. AUX: Press to switch to AUX input.
4. HDMI: Press to switch to HDMI mode.
5. MUSIC: Press to select the MUSIC sound mode.
6. MOVIE: Press to select the MOVIE sound mode.
7. TREBLE +: Press to increase treble sound (the white light flashes, when hit the maximum or minimum level white light will be on).
8. TREBLE -: Press to decrease treble sound (the white light flashes, when hit the maximum or minimum level white light will be on).
9. BASS -: Press to decrease bass sound (the white light flashes, when hit the maximum or minimum level white light will be on).
10. : Press to go to the previous track.
11. : Press to mute the sound.
12. USB: Press to switch to USB input.
13. OPTICAL: Press to switch to OPTICAL input.
14. DIALOG: Press to select the DIALOG sound mode.
15. : Press to increase volume.
16. : Press to decrease volume.
17. : Press to increase volume.
18. : Press to play or pause the media.
19. : Press to go to the next track.

10. ◀: Press to previous song under Bluetooth, USB or mode.
11. MUTE: Press the mute button and turn on the sound button (white light will flash slowly when mute).
12. USB: Press to switch to USB play when insert USB.
13. OPTICAL: Press to switch to the Optical input mode.
14. DIALOG: Short press to select the DIALOG sound mode.
15. BASS +: Press to increase bass (the white light flashes, when hit the maximum or minimum level white light will be on).
16. VOL +: Press or long press to increase volume (the white light flashes, when hit the maximum or minimum level white light will be on).
17. VOL -: Press or long press to decrease volume (the white light flashes, when hit the maximum or minimum level white light will be on).
18. ▶: Press to next song under Bluetooth or USB mode.
19. ▶||: Press to play or pause playing under Bluetooth or USB.

Install/replace the remote control batteries

Warnings

Batteries either installed or packed must not be to heat like direct sunlight, fire or similar.

Install the Remote Control:

The Remote Control has a pre-installed lithium CR2025 battery. Remove the protective tab to activate the Remote Control battery.

Note: The Remote Control works within a range of 6 meters.

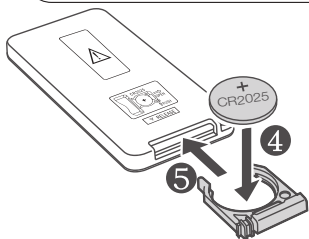
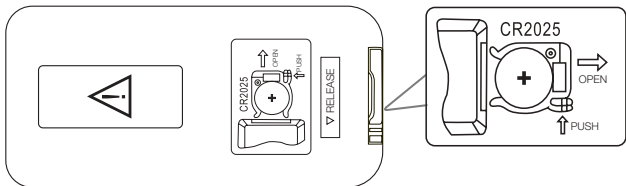
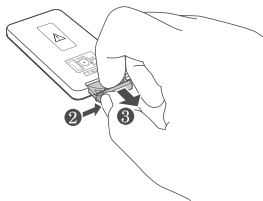
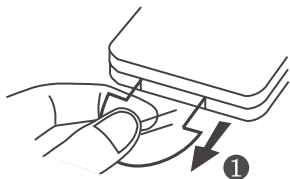

- This product contains a coin cell battery. If the coin cell battery is swallowed, it can cause severe internal burns in just 2 hours and can lead to death.
- Keep new and used batteries away from children.
- If the battery compartment does not close securely, stop using the product and keep it away from children.
- If you think batteries might have been swallowed or placed inside any part of the body, seek immediate medical attention.

CAUTION: Danger of explosion if battery is incorrectly replaced. Replace only with the same or equivalent type.

WARNING: The battery (battery or batteries or battery pack) shall not be exposed to excessive heat such as sunshine, fire or the like.

3 Set up your Sound Bar system

Make sure you read all the safety information before you mount the Sound Bar main unit on the wall.

Make sure you use screws provided or specified by the authorized manufacturer.

TCL Overseas Marketing Limited bears no responsibility for accidents or damage caused by improper wall mounting and screws installation or insufficient wall strength, etc. Additional tools (not supplied) are required for installation.

Position Your Sound Bar and Subwoofer

The ideal place to position the Sound Bar main unit is centered underneath your TV.

You are recommended to place the Sound Bar main unit on the top of the cabinet and right below the center of your TV. The distance between the subwoofer and the Sound Bar main unit should be less than 9.8'.

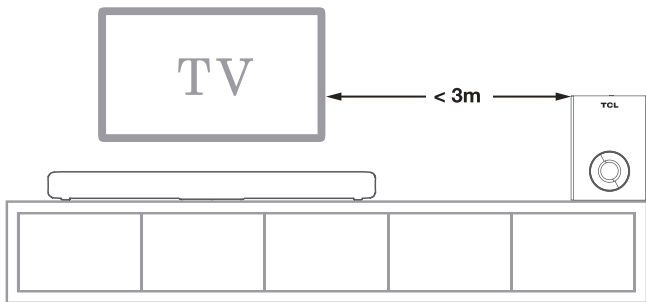

Mount your Sound Bar on the wall

You can choose to mount your Sound Bar main unit on the wall.

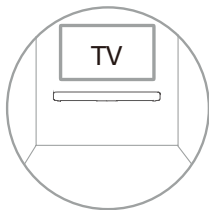

1. Place the supplied wall mount template on the wall. Make sure the wall mount template is at least 10cm below the center of the TV.
2. Use a level to make sure the Sound Bar is positioned accurately.
3. Use the tape to stick the wall mount template firmly on the wall.

4. Mark on the wall using each marking on the template through the mounting holes.
5. Take away the wall mount template.
6. Drill a screw hole at each marking on the wall.

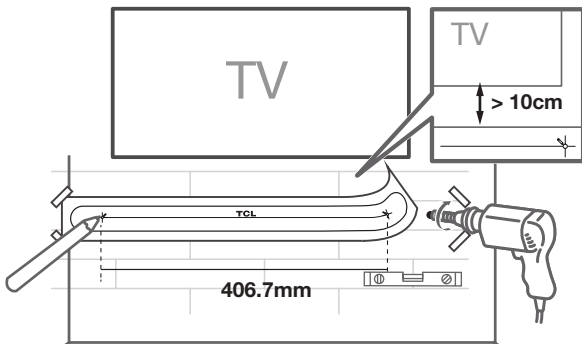

7. Take out the screws from the rear of the soundbar, 2 per side.
8. Use a screwdriver to attach the mounting brackets to the sound bar.
9. Installation complete.

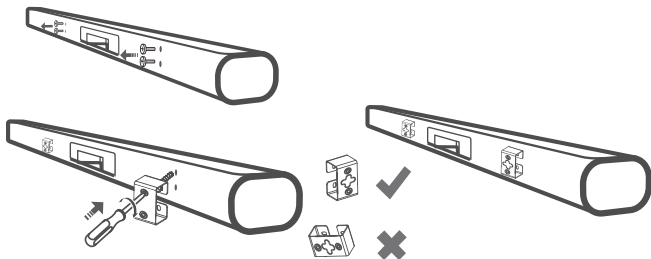

10. Insert the supplied wall anchors into 2 screw holes on the wall.
11. Insert the supplied screws into the wall anchors.
12. Fix and tighten the screws on the wall.
13. Hang the Sound Bar main unit on the screws.

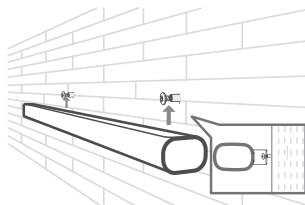
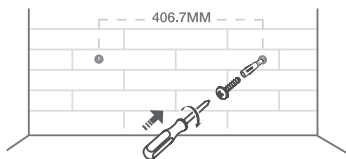

4 Connect your Sound Bar system

After you have fixed the position of the Sound Bar, you can start connecting it to your TV or other devices and listen to the audio through your Sound Bar. Make sure you have muted the audio of your TV or device. For information, check the user manual of your TV or device.

Connect with the AC power adaptor

Connect the supplied AC power adaptors to the sound bar main unit and subwoofer.

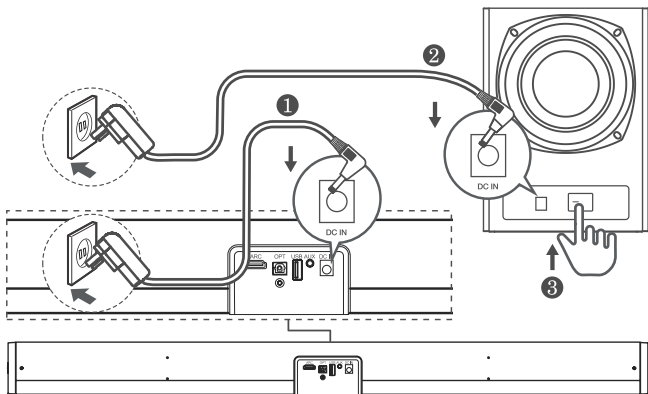

Connect with the HDMI cable

Note:

Make sure your TV or device supports the HDMI ARC feature. For information, check the user manual of your TV or device.

Connect one end of the HDMI cable to the HDMI ARC input connector on your Sound Bar and another end to the HDMI ARC output connector of your TV or device.

To get the best possible audio experience using the HDMI cable, follow below given steps:

For TCL TV:

- Connect HDMI cable from the HDMI (ARC) interface on the sound bar to the HDMI (ARC/eARC) interface on the TV. Connect power cord.
- Enable the CEC function in the settings of the TCL TV.

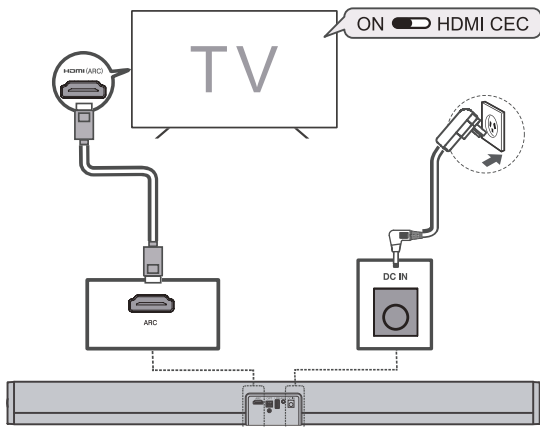

Connect with the optical cable

1. Remove the protective caps from the optical cable when necessary.
2. Connect one end of the optical cable to the optical input connector on your Sound Bar and another end to the optical output connector of your TV or device.

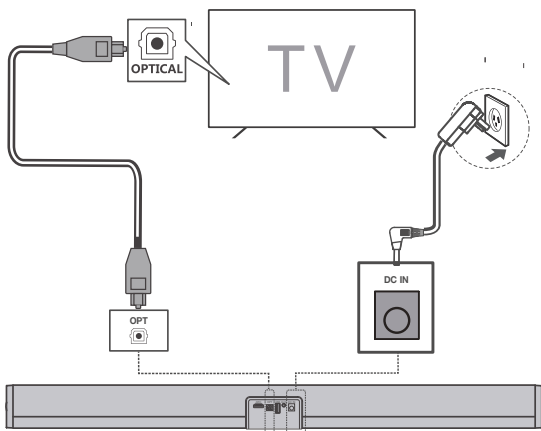

Note

- If there is no sound output from the Sound Bar, try to activate the PCM signal output on your TV or device. PCM is used to convert analog audio signals into digital audio signals in most devices. For more information of how to activate the PCM signal output, check the user manual of your TV or device.

Direction for setting up your Sound Bar using an optical cable



Do not bend or kink the optical cable (SPDIF) as it is fragile and can easily get damaged and broken.

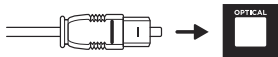

To get the best possible audio experience using the optical cable:

- 1 Press the Home button on your TCL TV Remote.
- 2 Navigate to **Audio option** under **Settings**.
- 3 Uncheck the “**TV speaker enabled**” option.
- 4 Under **S/PDIF** and **ARC**, select **PCM-Stereo**.

Notes

- *Different devices may have different menu options.*
- *Devices such as Blu-ray players, set-top boxes, etc. are also applicable.*

Connect with USB disk

- Press **▶||** on the remote control to listen to/pause/ resume the music.
- Press **◀|** or **▶|** on the remote control to skip to the previous or next track.
- Press **+** or **-** to increase or decrease the volume level.

5 Use your Sound Bar system

Get Started:

1. Make sure you have made all the necessary cable connections before connecting the Soundbar to a wall outlet, the soundbar will enter to standby mode, the indicator will light up in red.
 2. Make sure the subwoofer is connected to the power, and turn the button to "ON"
 3. Press "⏻" on unit or remote control to turn on the soundbar. The Bluetooth indicator will light up.
 4. Press "⏻" on unit or on remote control to choose various source.
-

Operation instruction

● Bluetooth Mode

After power on, the machine directly enters Bluetooth mode, along with voice prompt and white light slow flash; long press "📶" on Soundbar, Bluetooth enters the pairing status, with voice prompts and white light fast flash.

1. Put the phone within 3m in distance;
2. Activate the Bluetooth function of the phone, so that the phone starts to search for the Bluetooth device (please refer to the phone instructions for details);
3. Select "TCL S522W" from the device that has been

- searched for, click connection, with voice prompt;
4. If the phone remind you to enter password, enter "0000" and press confirm button to match soundbar to the phone;
 5. Press the back button of the phone to exit the phone menu. Make sure the distance between soundbar and phone is within 10m and there is no obstacles. At this time, music can be played on the soundbar;
 6. Short press "▶||" to play and pause music. Short press "◀◄" or "▶" button to previous or next song;
 7. To disconnect, short press or long press the "📶" button on the soundbar, At this time, another mobile phone device can be used to connect Bluetooth playing; If the connection is not selected, the machine will be on waiting for connection status.

● **AUX Mode**

After power on, connect the external audio sources to the AUX jack of soundbar by using the 3.5mm audio cable, and then Press the "🔊" button on the soundbar or the "AUX" button on the remote control to switch to "AUX" mode. At this time, music from the external audio sources such as MP3/CD can be played. (please adjust the volume of the external audio sources accordingly at a comfortable level.)

● **HDMI Mode**

Press the "🔊" button on the soundbar or "HDMI" button on the remote control to switch to "HDMI" mode. At this point, connect the HDMI cable to the TV set and then to the HDMI IN(ARC) jack on the back of the soundbar. Turn on the TV to power on the soundbar. Directly detect the digital signal

transmitted by the TV to decode and restore the music play. (Control the TV switch can control the soundbar switch directly).

● OPTICAL Mode

Press the "⏏" button on the soundbar or "OPTICAL" button on the remote control to switch to "OPTICAL" mode. At this time, connect the DVD audio and equipment to Soundbar's OPTICAL jack with the optical cable. This machine decodes optical fiber digital to restore sound through power amplifier.

● USB Mode

After power on, insert the USB into the USB jack of the soundbar; the sound bar automatically goes to USB playback mode and plays the music in USB. Press the "▶||" button to play and pause the music. Press "◀" or "▶" button to select music up and down.

Volume and Sound effect regulation

A. After power on, in any mode of playback, Press or long press the volume "-" button on the soundbar or remote control to lower the volume. Press or long press the volume "+" button on the soundbar or remote control to raise the volume.

Note: during volume increase and decrease, the indicator light flash; when the volume is increased to the maximum or decreased to the minimum, the indicator light will be on. So remind the user!

B. After power on, in any mode of playback, Press the

remote control to choose sound effect mode: MUSIC, MOVIE and DIALOG.

Note:

1. Under MOVIE mode, there is no function when press "BASS(+, -)", "TREBLE(+, -); Under MUSIC and DIALOG mode, It can adjust sound effect between positive and negative six grades when press"BASS (+, -)", "TREBLE (+, -)" on the remote control.

2. The user can adjust each kind of sound effect mode to enjoy the music according to the personal preference!

6 Specification

Product name	S522W
Output power	20W*2+30W
AC/DC adaptor	Input: 100-240V-50/60Hz 1.2A MAX Output: 14V  2A
Speaker frequency	50Hz-20KHz
Bluetooth version	5.1
Bluetooth range	Up to 10m
Included in the packaging	Soundbar, Subwoofer, Remote control, AC adaptors, AUX cable (3.5mm to RCA), UM, Wall-mounted bracket and screws, Wall mount template
Dimensions/Weight	Soundbar: 810 x 70 x 99 mm/1.34 kg Subwoofer: 165 x 240 x 298 mm/2.05 kg
Remote Control	Distance/Angel: 6m/30° Battery type: Lithium CR2025 battery

7 Notice

Declaration of conformity

Hereby, TCL Overseas Marketing Limited declares that this radio equipment type Sound Bar is in compliance with relevant UK statutory requirements.

The full text of the declaration of conformity is available at the following internet address: <http://www.tcl.com> go to Support and enter the model name.

Disposal of your old product and battery



Your product is designed and manufactured with high quality materials and components, which can be recycled and reused.



This symbol on a product means that the product is covered by European Directive 2012/19/EU.



This symbol means that the product contains a battery covered by European Directive 2013/56/EU

which cannot be disposed of with normal household waste. Inform yourself about the local separate collection system for electrical and electronic products and batteries. Follow local rules and never dispose of the product and batteries with normal household waste. Correct disposal of old products

and batteries helps prevent negative consequences for the environment and human health.

Remove the disposable battery

To remove the disposable batteries, see the section ‘Install/replace the remote control battery’.

Environmental protection and sustainability

We have omitted all unnecessary packaging and make sure it is eco-friendly and sustainable.

Trademarks

Bluetooth



The Bluetooth® word mark and logos are registered trademarks owned by Bluetooth SIG, Inc. and any use of such marks by TTE Corporation is under license. Other trademarks and trade names are those of their respective owners.

HDMI



The terms HDMI, HDMI High-Definition Multimedia Interface, HDMI trade dress and the HDMI Logos are trademarks or registered trademarks of HDMI Licensing Administrator, Inc.

8 FAQ

Question	Answer approach
Bluetooth paired connection cannot be completed	Another mobile device may be connected to the soundbar. Disconnect the other connected bluetooth device. Once the device is disconnected, your device should pair automatically-provided it was previously paired.
Volume of Bluetooth playback is low	<ol style="list-style-type: none"><li data-bbox="360 612 928 754">1. After connections with mobile devices, the volume of Bluetooth device is not up-but at the default output level. Turn up the mobile device volume.<li data-bbox="360 758 909 827">2. Output volume of Bluetooth device is low itself.
Short Bluetooth connection distance	Obstruction exists between mobile devices and Bluetooth device. Remove obstructions.

<p>Bluetooth connection plays normally, sometimes with broken sound.</p>	<ol style="list-style-type: none"> 1. Obstruction exists between mobile devices and Bluetooth device. Remove obstructions. 2. Too far away from Bluetooth device to connected mobile devices, beyond the connection range. Shorten the distance between the Bluetooth device and mobile devices.
<p>Subwoofer not working</p>	<p>Turn on the soundbar and enter Bluetooth mode, double press quickly the pair button, then turn on the subwoofer, the red LED light on subwoofer will be off.</p>
<p>Play no sound</p>	<p>Make sure you activate the PCM signal output on your TV or device when the HDMI ARC/Optical audio source is selected on the sound bar. For more information of how to activate the PCM signal output, check the user manual of your TV or device.</p>

Note: As the above methods are all excluded, the device still can not work, please notify the technician or the customer service!

WARNING:

BATTERIES EITHER INSTALLED OR PACKED MUST NOT BE TO HEAT LIKE DIRECT SUNLIGHT, FIRE OR SIMILAR.

TCL support:

Please visit www.tcl.com

**WE ARE
READY TO**

HELP contact us first
with any questions



**TAKE CARE WHEN
REMOVING THE SOUND BAR**

Copyright © 2023 TCL. All rights reserved.

EN_S522W-EU_UM_V1.3

