

TCL

S522W Series

2.1 Channel Sound Bar with Wireless Subwoofer

Quick Start Guide



English | Albanian | Bulgarian | Croatian | Czech | Danish | Dutch | Estonian | Finnish | French | German | Greek | Hungarian | Italian | Latvian | Lithuanian | Macedonian | Norwegian | Polish | Portuguese | Romanian | Russian | Serbian | Slovak | Slovene | Spanish | Swedish | Turkish | Ukranian

1



EN Make sure you read all the safety information before you use this product.

SQ Siguroruni që të lexoni të gjithë informacionin e sigurisë përpara se të përdorni produktin.

BG Преди да използвате продукта, задължително прочетете всички инструкции за безопасност.

HR Obavezno pročitaite sve sigurnosne informacije prije korištenja ovog proizvoda.

CS Před použitím tohoto výrobku si přečtěte všechny bezpečnostní informace.

DA Læs alle sikkerhedsoplysninger, før du bruger produktet.

NL Zorg ervoor dat u alle veiligheidsinformatie leest voordat u dit apparaat gebruikt.

ET Enne seadme kasutamist lugege kindlasti kõiki ohutuseeskirju.

FI Lue kaikki turvallisuuohjeet ennen tuotteen käyttöä.

FR Assurez-vous d'avoir lu toutes les informations relatives à la sécurité avant d'utiliser cet appareil.

DE Vergewissern Sie sich, dass Sie sämtliche Sicherheitshinweise gelesen haben, bevor Sie dieses Produkt verwenden.

EL Βεβαιωθείτε ότι έχετε διαβάσει όλες τις πληροφορίες ασφαλείας πριν χρησιμοποιήσετε αυτό το προϊόν.

HU A készülék használatba vétele előtt olvassa el az összes biztonsági előírást.

IT Assicurarsi di aver letto tutte le informazioni sulla sicurezza prima di utilizzare questo prodotto.

LV Pirms produkta lietošanas noteikti izlasiet visu drošības informāciju.

LT Prieš pradėjami naudoti šį gaminį, būtina perskaitykite visus saugos nurodymus.

MK Погрижете се да ги прочитате сите безбедносни информации пред да го користите овој производ.

NO Sørg for å lese alle sikkerhetsinstruksjonene før du bruker produktet.

PL Przed użyciem produktu należy dokładnie przeczytać wszystkie wskazówki dotyczące bezpieczeństwa.

PT Certifique-se de ler todas as informações de segurança antes de usar este produto.

RO Asigurați-vă că ați citit toate informațiile de siguranță înainte de a utiliza acest produs.

RU Прежде чем приступать к эксплуатации устройства, прочтите все инструкции по безопасности.

SR Obavezno pročitaite sve informacije o bezbednosti pre upotrebe ovog proizvoda.

SK Pred použitím tohto produktu si prečítajte všetky bezpečnostné informácie.

SL Zagotovite, da ste pred uporabo tega izdelka prebrali vse varnostne informacije.

ES Asegúrese de leer toda la información de seguridad antes de utilizar este producto.

SV Se till att du läser all säkerhetsinformation innan du använder produkten.

TR Bu ürünü kullanmadan önce tüm güvenlik bilgilerini okuduğunuzdan emin olun.

UA Уважно ознайомтеся із усією інформацією стосовно техніки безпеки перед використанням пристрою.

A



B

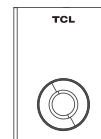

C



x2

D



E



F



G



H

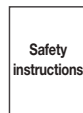

I



J

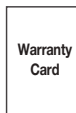

K

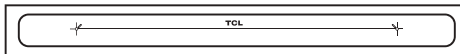

L



2



A

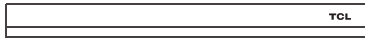

B

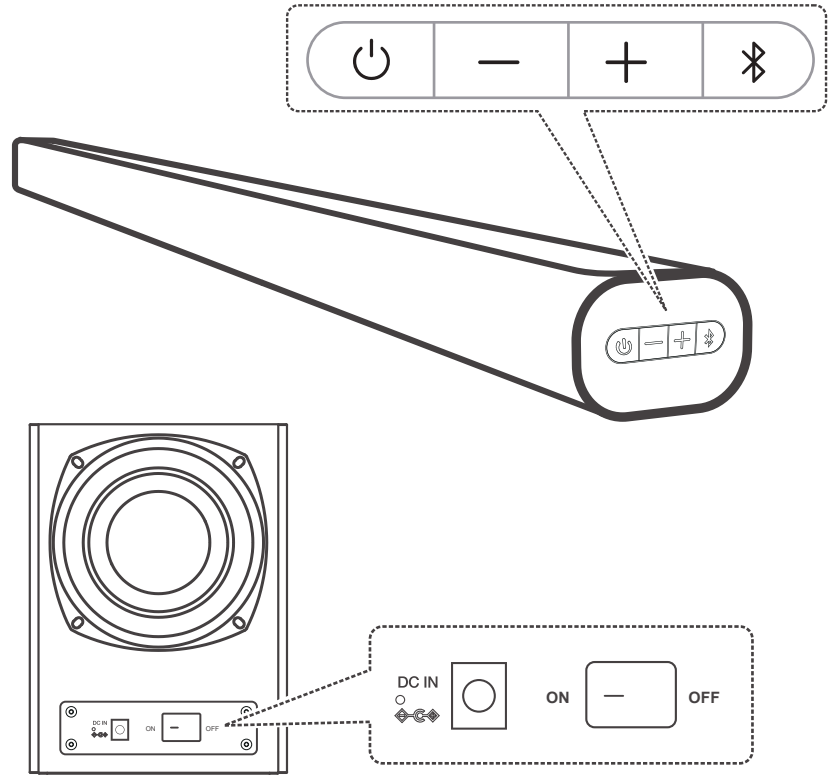

3a

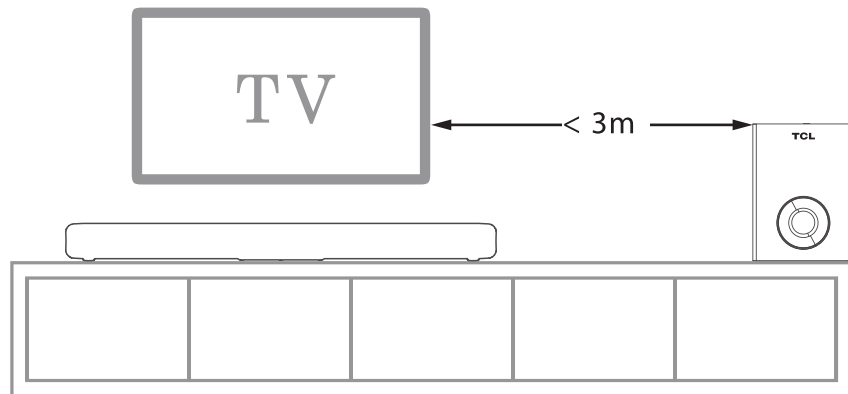
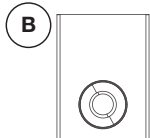

3b

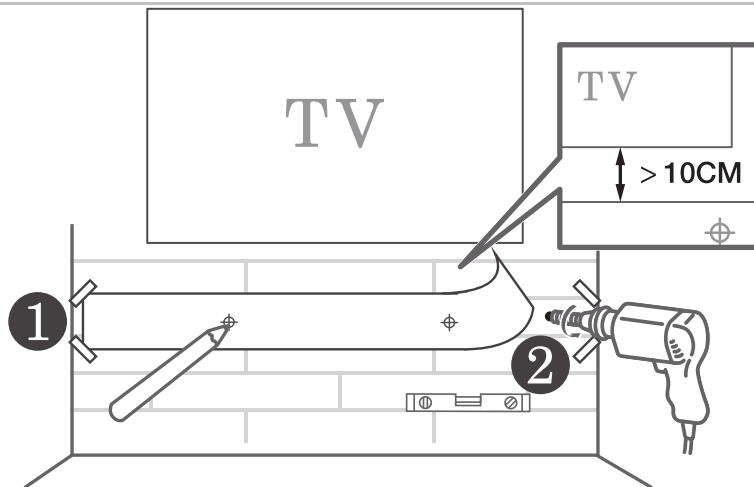
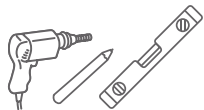
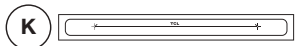

3c

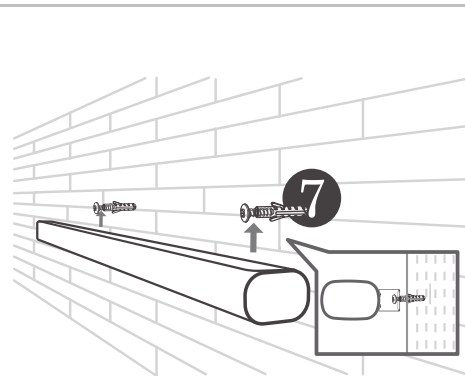
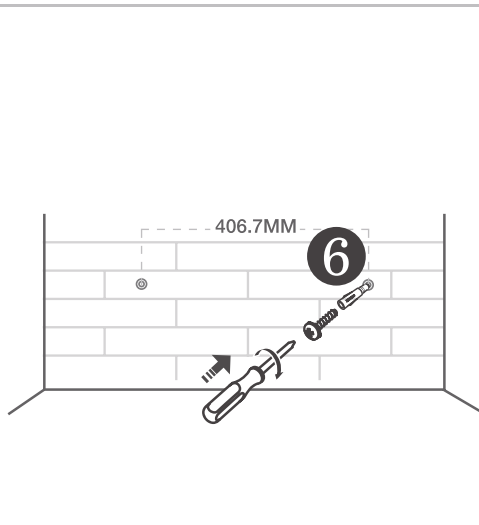
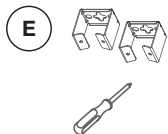
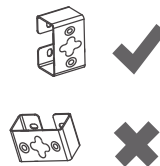
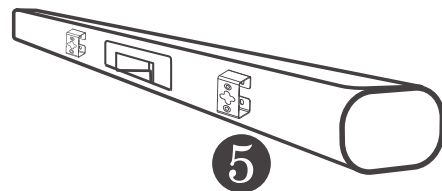
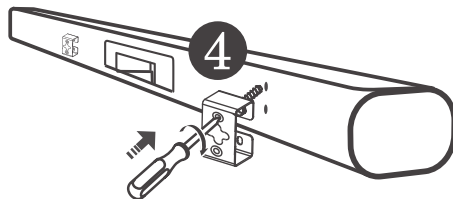
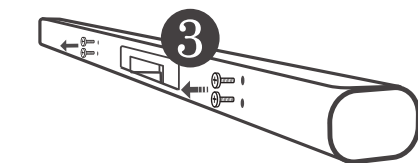
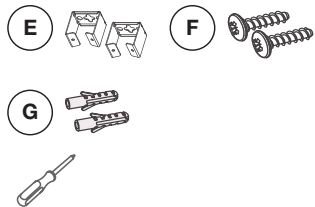

4



L

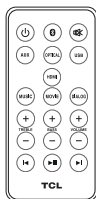

- EN Battery type: CR2025
- SQ Lloji i baterisë: CR2025
- BG Тип батерија: CR2025
- HR Tip baterije: CR2025
- CS Typ baterie: CR2025
- DA Batteritype: CR2025
- NL Soort batterij: CR2025
- ET Patarei tüüp: CR2025
- FI Akun tyyppi: CR2025
- FR Type de pile : CR2025
- DE Batterietyp: CR2025
- EL Τύπος μπαταρίας: CR2025
- HU Elem típusa: CR2025
- IT Tipo di batteria: CR2025
- LV Akumulatoru tips: CR2025
- LT Baterijų tipas: CR2025
- MK Тип батерија: CR2025
- NO Batteritype: CR2025
- PL Typ baterii: CR2025
- PT Tipo de pilha: CR2025
- RO Tipul bateriei: CR2025
- RU Тип батареи: CR2025
- SR Тип батерије: CR2025
- SK Typ batérie: CR2025
- SL Vrsta baterije: CR2025
- ES Tipo de batería: CR2025
- SV Batterityp: CR2025
- TR Pil türü: CR2025
- UA Тип батареї: CR2025

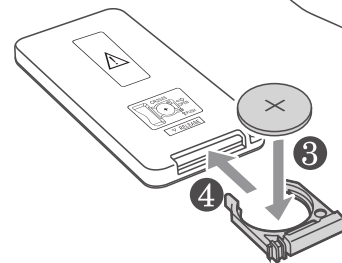
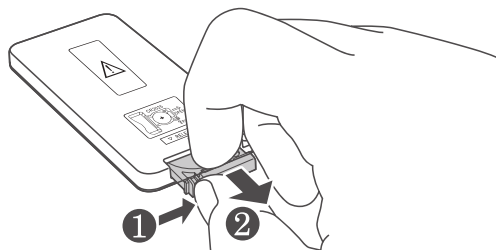
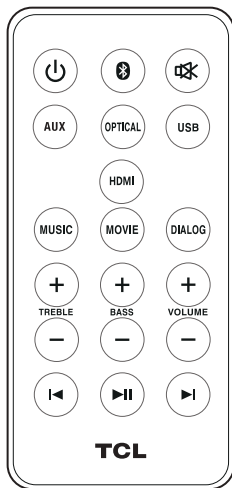
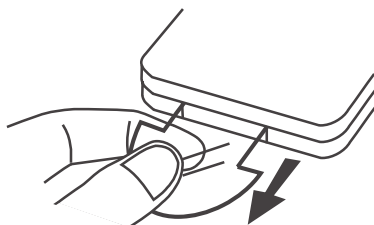

5



C

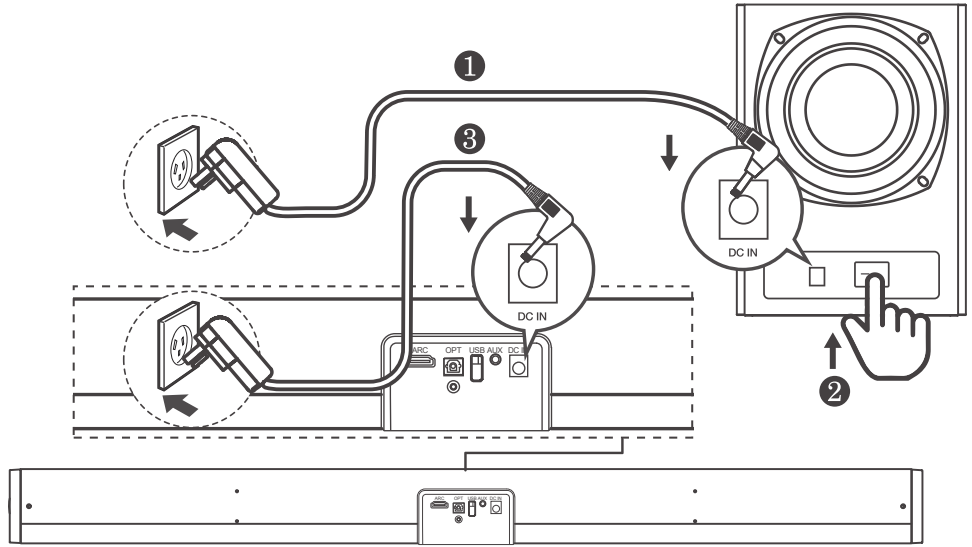
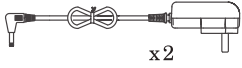

6



- EN** Cables are sold separately.
SQ Kabllot shiten veçmas.
BG Кабелите се продават отделно.
HR Kabeli se prodaju zasebno.
CS Kabele se prodávají samostatně.
DA Kabler sælges særskilt.
NL De kabels worden afzonderlijk verkocht.
ET Kaablid müüakse eraldi.
FI Kaapelit myydään erikseen.
FR Les câbles sont vendus séparément.
DE Kabel können separat erworben werden.
EL Τα καλώδια πωλούνται ξεχωριστά.
HU A kábeleket külön kell megvásárolni.
IT I cavi vengono venduti separatamente.
LV Kabeļi tiek pārdoti atsevišķi.
LT Laidai parduodami atskirai.
MK Каблите се продаваат отделно.
NO Kabler selges separat.
PL Kable są sprzedawane oddzielnie.
PT Os cabos são vendidos separadamente.
RO Cablurile se vând separat.
RU Кабели продаются отдельно.
SR Каблови се продају одвојено.
SK Káble sa predávajú samostatne.
SL Kable je treba kupiti ločeno.
ES Los cables se venden por separado.
SV Kablar säljs separat.
TR Kablolar ayrı olarak satılır.
UA Кабелі продаються окремо.

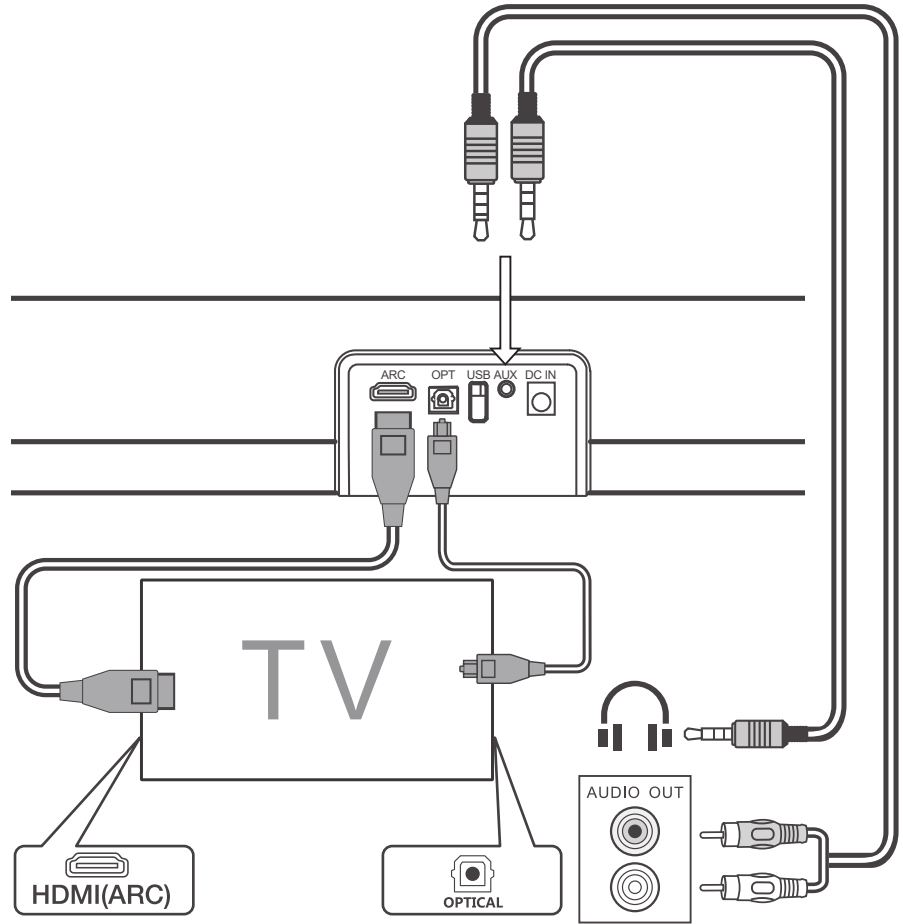

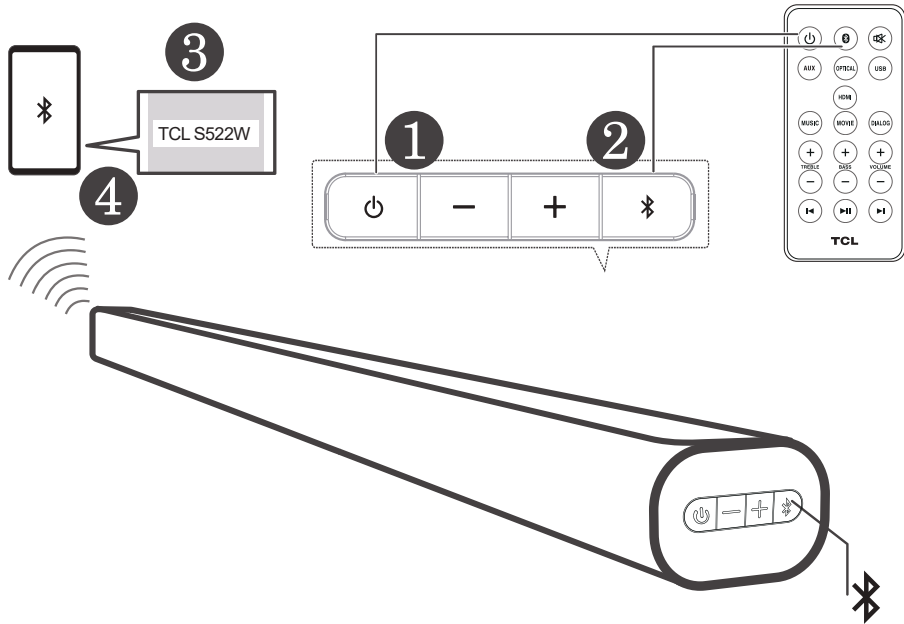

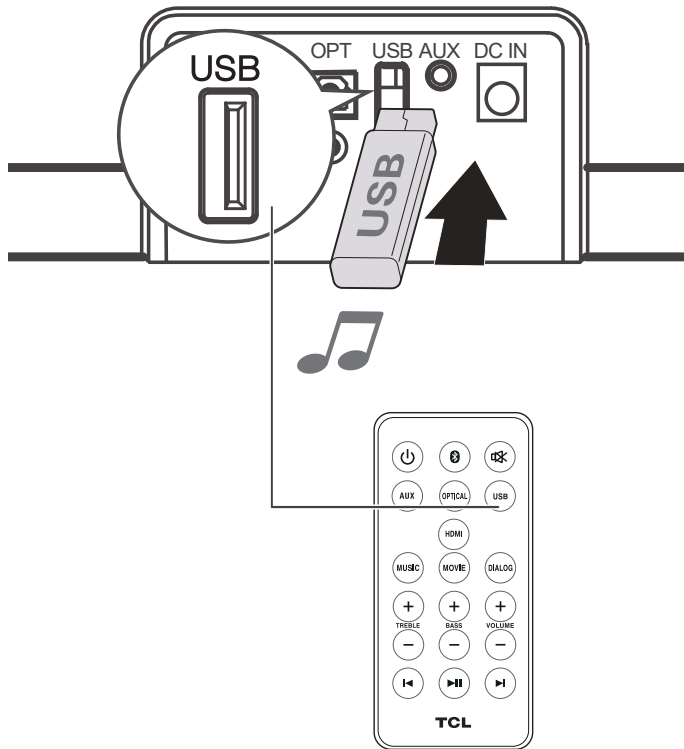

9

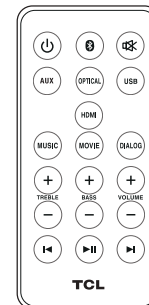
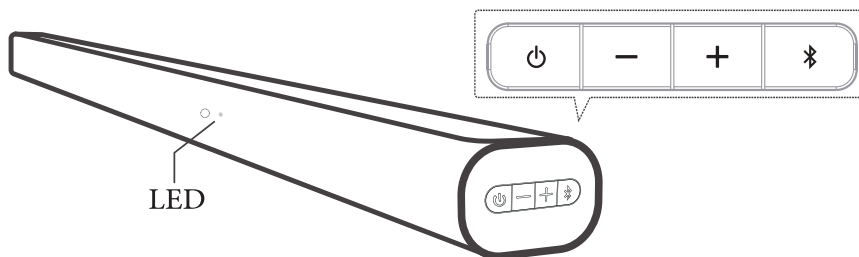

EN		SQ		BG	
Source/Status	LED	Burimi/statusi	LED	Източник/ Статус	LED
Standby	Red	Në pritje	E kuqe	Режим на готовност	Червен
Source	White (20s, light off)	Burimi	E bardhë (20 sekonda, drita e fikur)	Burimi	Бяло (20 секунди, светлината изключена)
HR		CS		DA	
Izvor/Status	LED	Zdroj/stav	LED	Kilde/status	Lysdiode
Mirovanje	Crveno	Pohotovostní režim	Červená	Standby	Rød
Izvor	Bijela (20 sekundi, svjetlo isključeno)	Zdroj	Bílá (20 sekund, světlo vypnuté)	Kilde	Hvid (20 sekunder, lys slukket)

9

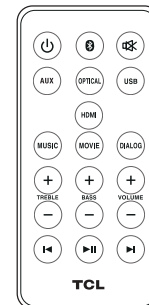
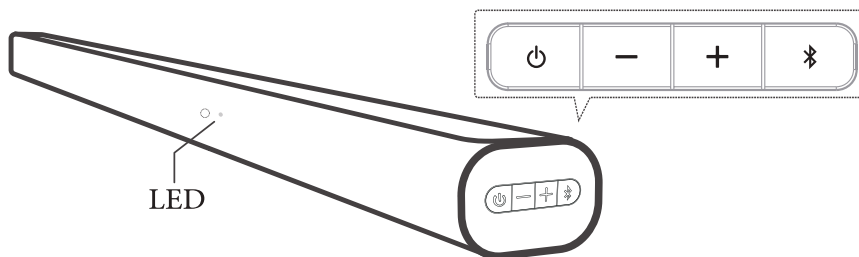

NL		ET		FI	
<i>Bron/status</i>	<i>LED</i>	<i>Allikas/olek</i>	<i>LED</i>	<i>Lähde/tila</i>	<i>LED</i>
Stand-by	Rood	Ooterežiim	Punane	Valmiustila	Punainen
Bron	Wit (20 seconden, licht uit)	Allikas	Valge (20 sekundit, tuli väljas)	Lähde	Valkoinen (20 sekuntia, valo pois päältä)
FR		DE		EL	
<i>Source/État</i>	<i>Voyant</i>	<i>Quelle/Status</i>	<i>LED</i>	<i>Πηγή/Κατάσταση</i>	<i>Lysdiode</i>
Veille	Rouge	Standby	Rot	Αναμονή	Κόκκινο
Source	Blanc (20 secondes, lumière éteinte)	Quelle	Weiß (20 Sekunden, Licht aus)	Πηγή	Λευκό (20 δευτερόλεπτα, φως σβηστό)

9

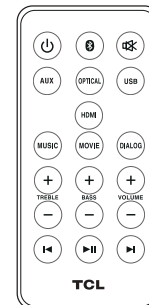
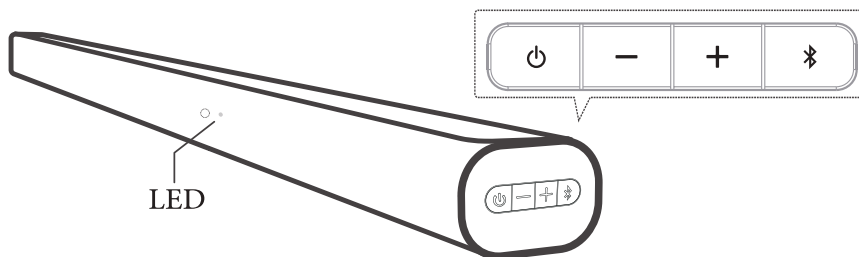

HU		IT		LV	
Jelforrás/állapot	LED	Sorgente/Stato	LED	Lähde/tila	LED
Készenlét	Piros	Standby	Rosso	Gaidstāve	Sarkans
Jelforrás	Fehér (20 másodperc, nem világít)	Sorgente	Bianco (20 secondi, luce spenta)	Lähde	Balts (20 sekundes, gaisma izslēgta)
LT		MK		NO	
Šaltinis/būsena	Voyant	Извор/смауyc	LED	Kilde/Status	LED
Budėjimo veikseną	Raudona	Во мирување	Црвено	Standby	Rød
Šaltinis	Balta (20 sekundžių, šviesa išjungta)	Извор	Бело (20 секунди, светло исклучено)	Kilde	Hvit (20 sekunder, lys av)

9

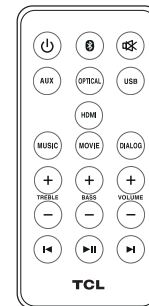
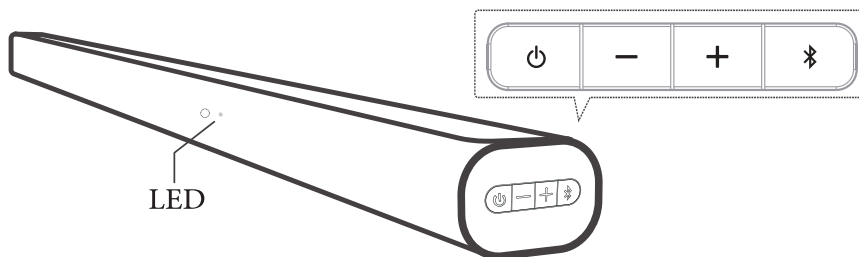

PL		PT		RO	
Źródło/Stan	LED	Fonte/Estado	LED	Sursă/Stare	LED
Czuwanie	Czerwony	Em espera	Vermelho	Mod așteptare	Roșu
Źródło	Biały (20s, światło wyłączone)	Fonte	Branco (20s, luz apagada)	Sursă	Alb (20s, lumina stinsă)
RU		SR		SK	
Источник/ Состояние	Светодиод	Извор/смагус	LED	Zdroj/Stav	LED
Ожидание	Красный	Приправност	Црвено	Pohotovostný režim	Červená
Источник	Белый (20 с, свет не горит)	Извор	Бела (20с, светло искључено)	Zdroj	Biela (20 s, svetlo vypnuté)

9

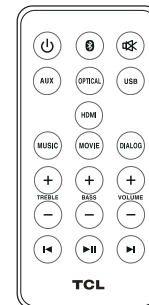
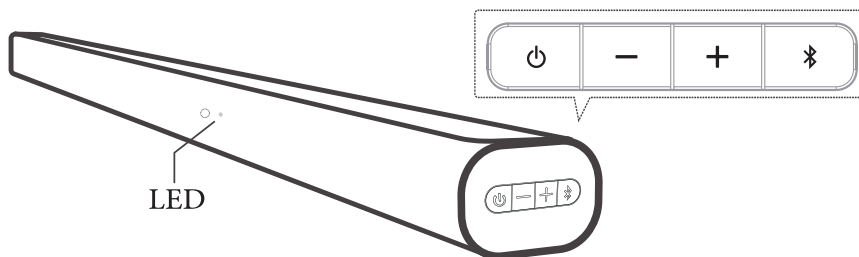

SL		ES		SV	
Vir/stanje	LED	Fuente/Estado	LED	Källa/status	LED
V pripravljenosti	Rdeča	Espera	Rojo	Viloläge	Röd
Vir	Bela (20s, luč ugasnjena)	Fuente	Blanco (años 20, luz apagada)	Källa	Vit (20s, ljus av)
TR		UA			
Kaynak/Durum	Светодиод	Джерело/Стан	LED		
Bekleme	Kırmızı	Режим очікування	Червоний		
Kaynak	Beyaz (20s, ışık kapalı)	Джерело	Білий (20 секунд, світло вимкнено)		

WE ARE READY TO HELP

contact us first
with any questions



TCL SUPPORT:
www.tcl.com

HDMI™
HIGH-DEFINITION MULTIMEDIA INTERFACE

The Adopted Trademarks HDMI, HDMI High-Definition Multimedia Interface, and the HDMI Logo are trademarks or registered trademarks of HDMI Licensing Administrator, Inc. in the United States and other countries.

 **Bluetooth**®

The Bluetooth® word mark and logos are registered trademarks owned by Bluetooth SIG, Inc. and any use of such marks by TTE Corporation is under license. Other trademarks and trade names are those of their respective owners.

**UK
CA**

CE

Copyright © 2022 TCL.
All rights reserved.

S522W_EU_QSG_V1.4