

CORNER WARDROBE(L) INSTALLATION  
MODEL NO: W3002-CL

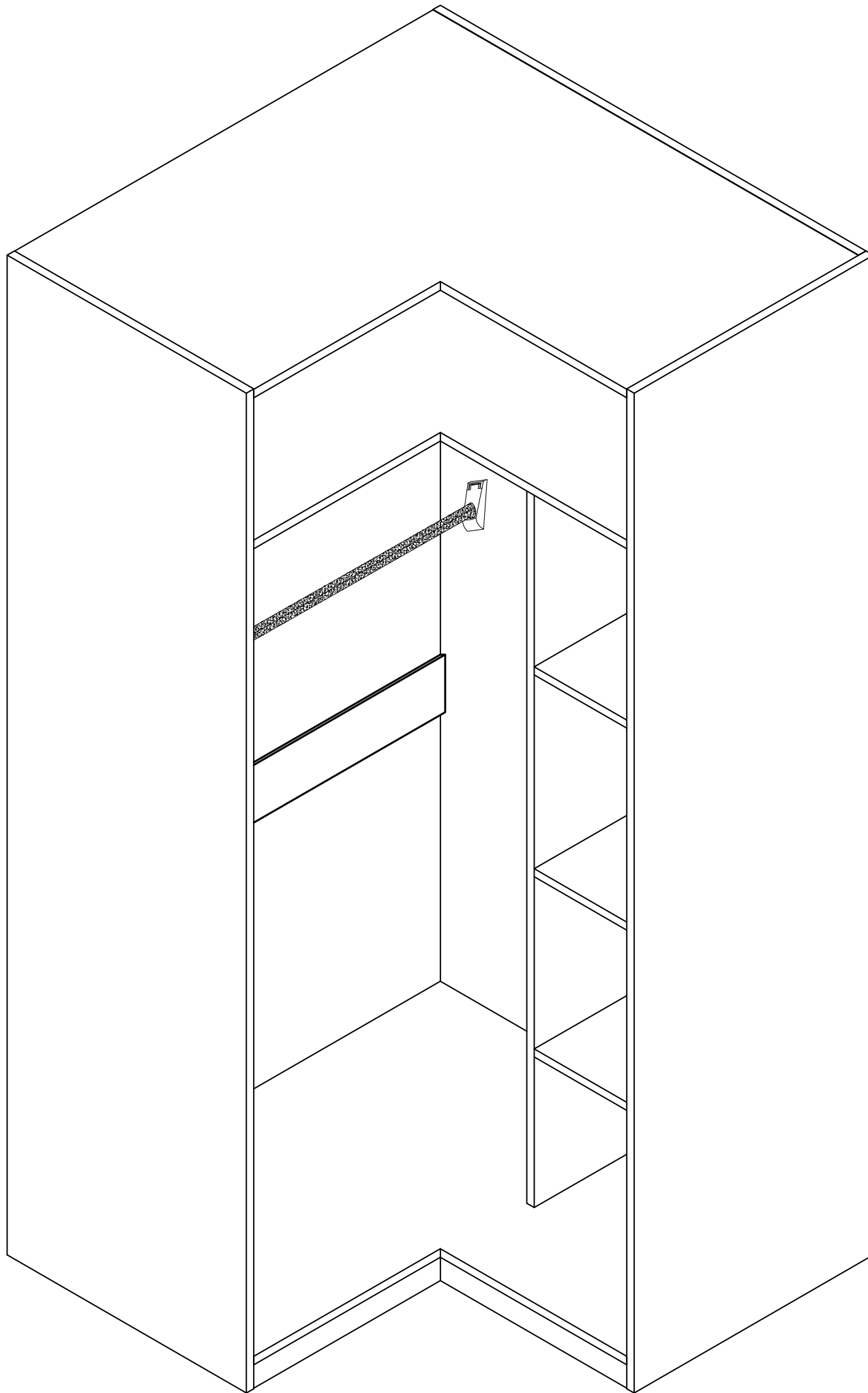

# Tool Needed

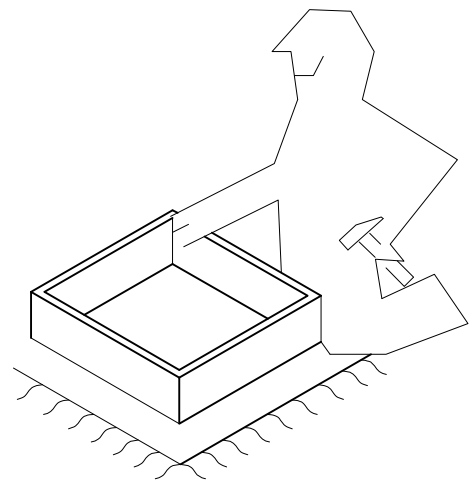
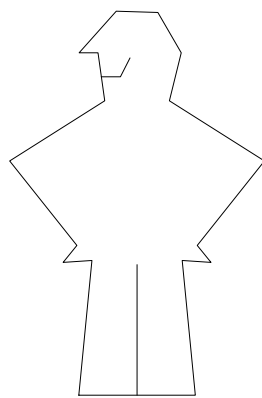
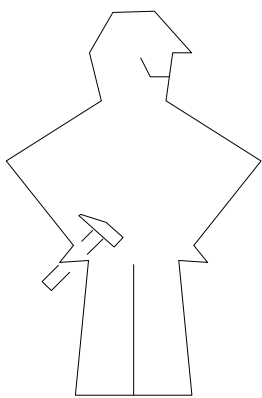
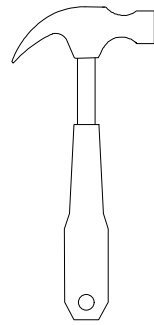
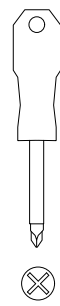
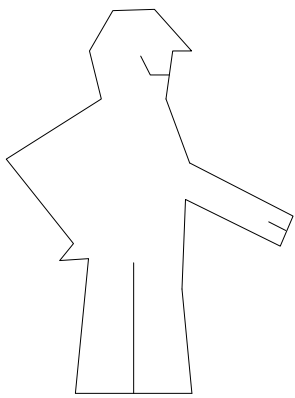

Two Man Work

Protection On Floor

# Accessories Instruction

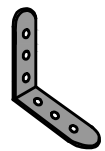
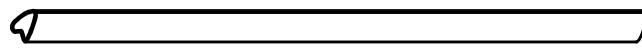
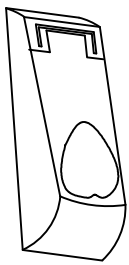
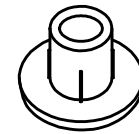
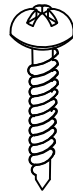
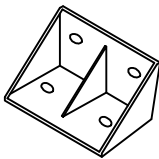
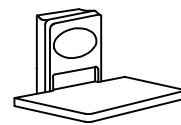
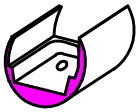
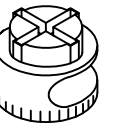
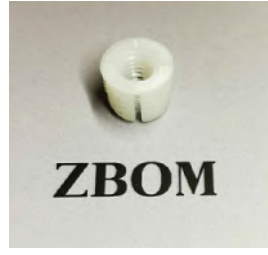
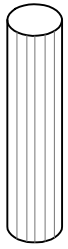

# Size of each panel

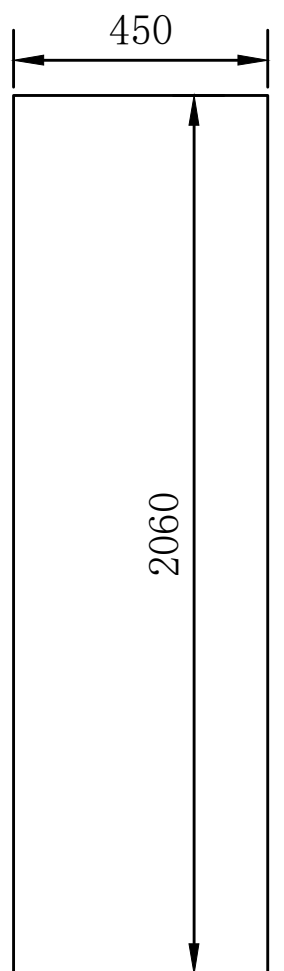
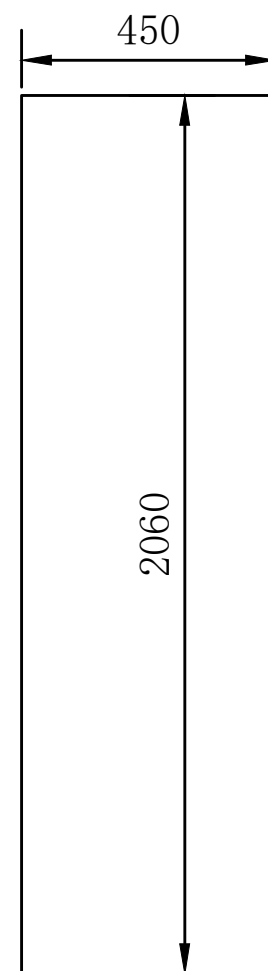
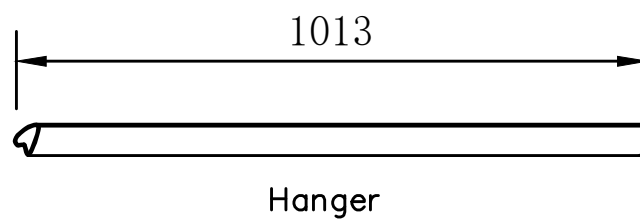
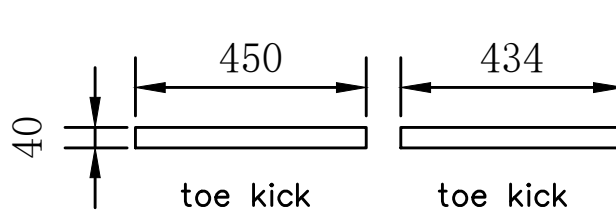
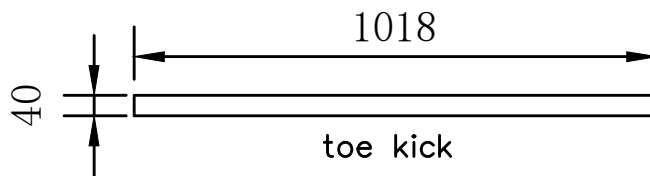
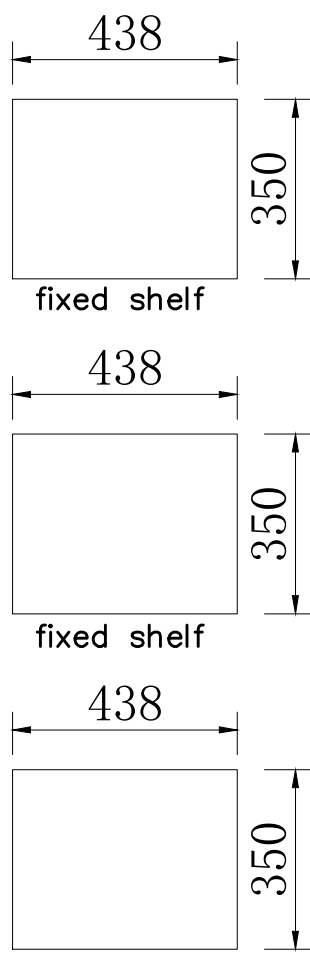
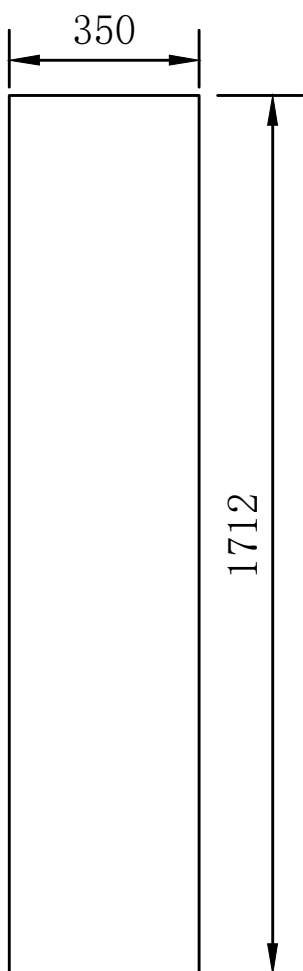
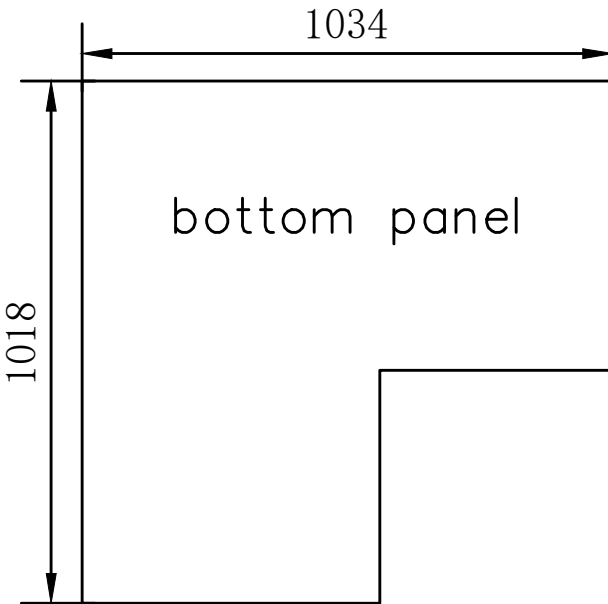
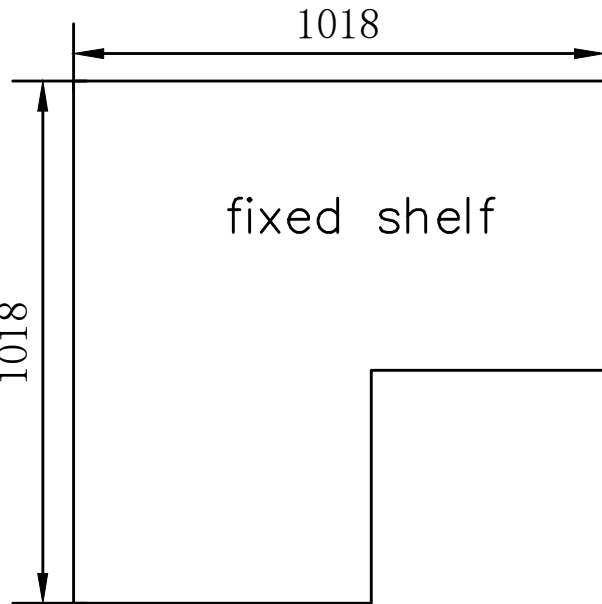
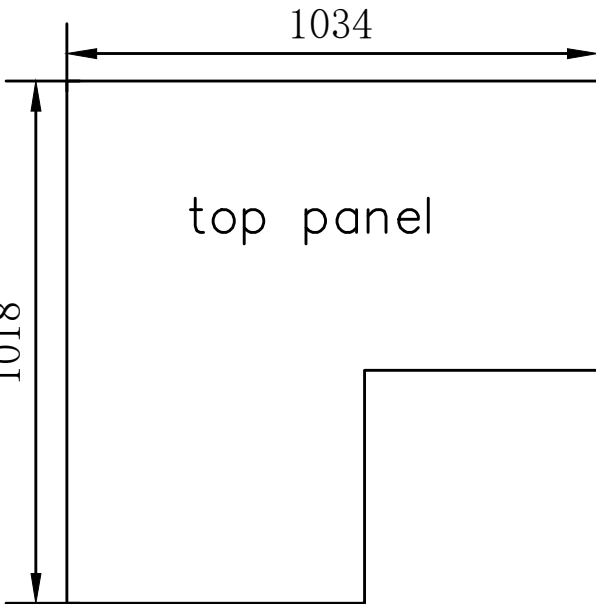
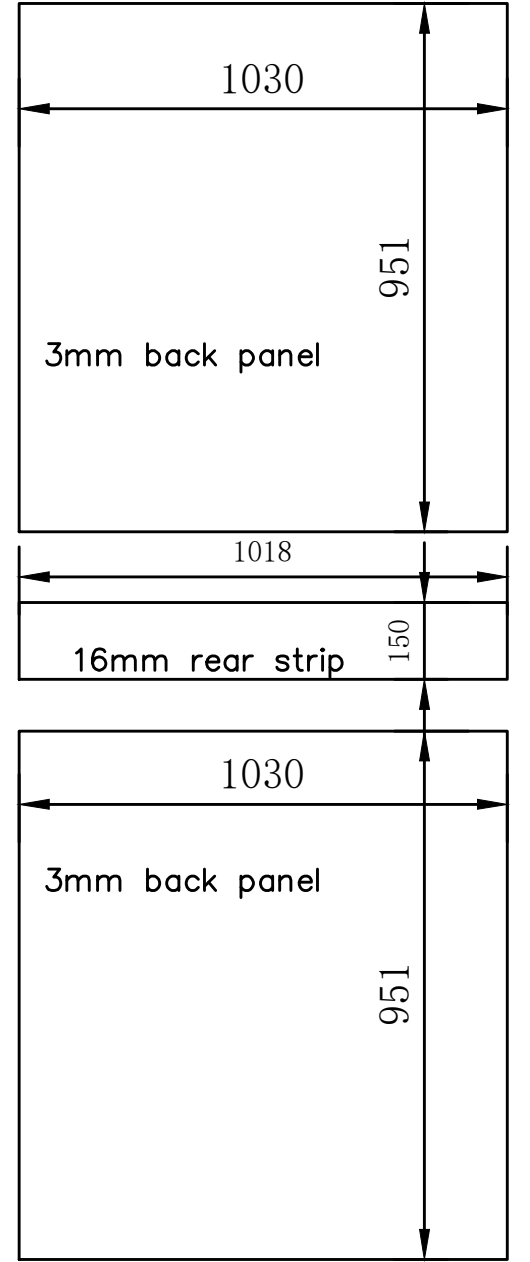
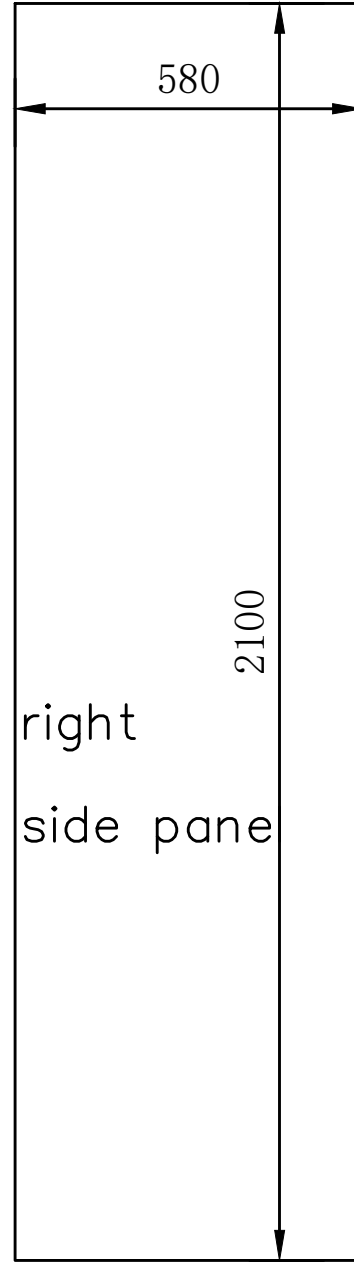
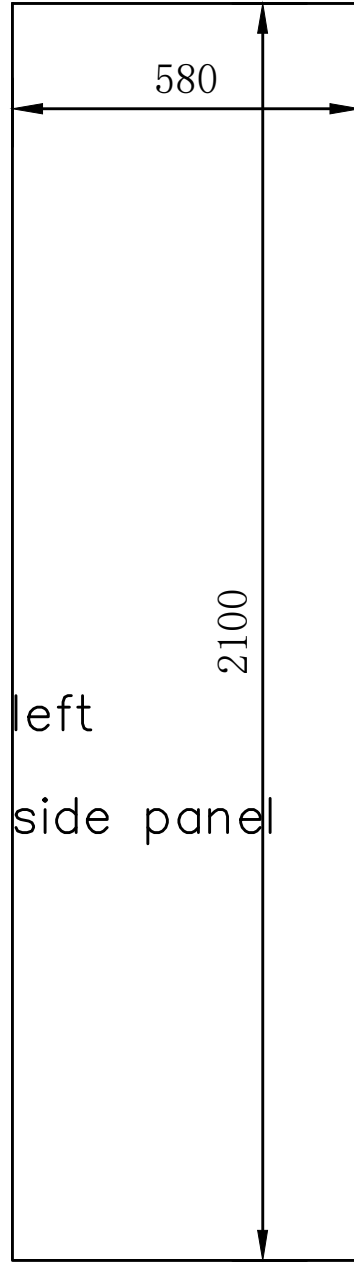
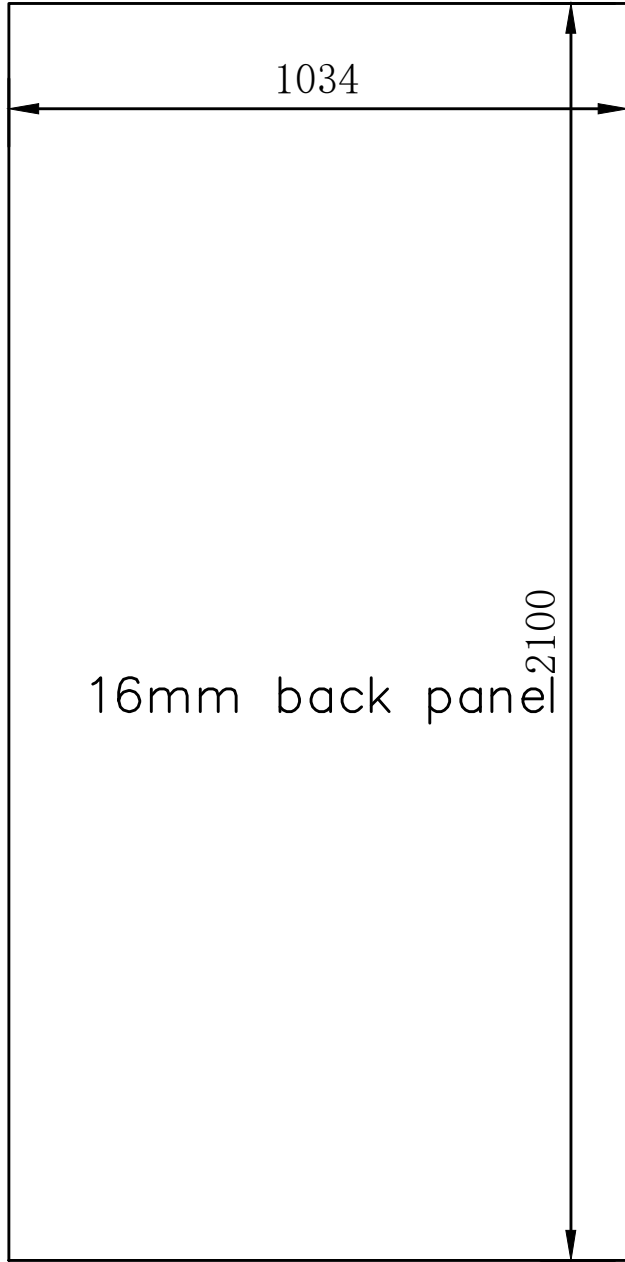

# Opening hole location diagram

