

CORNER WARDROBE(R) INSTALLATION

MODEL NO: W3001-CR

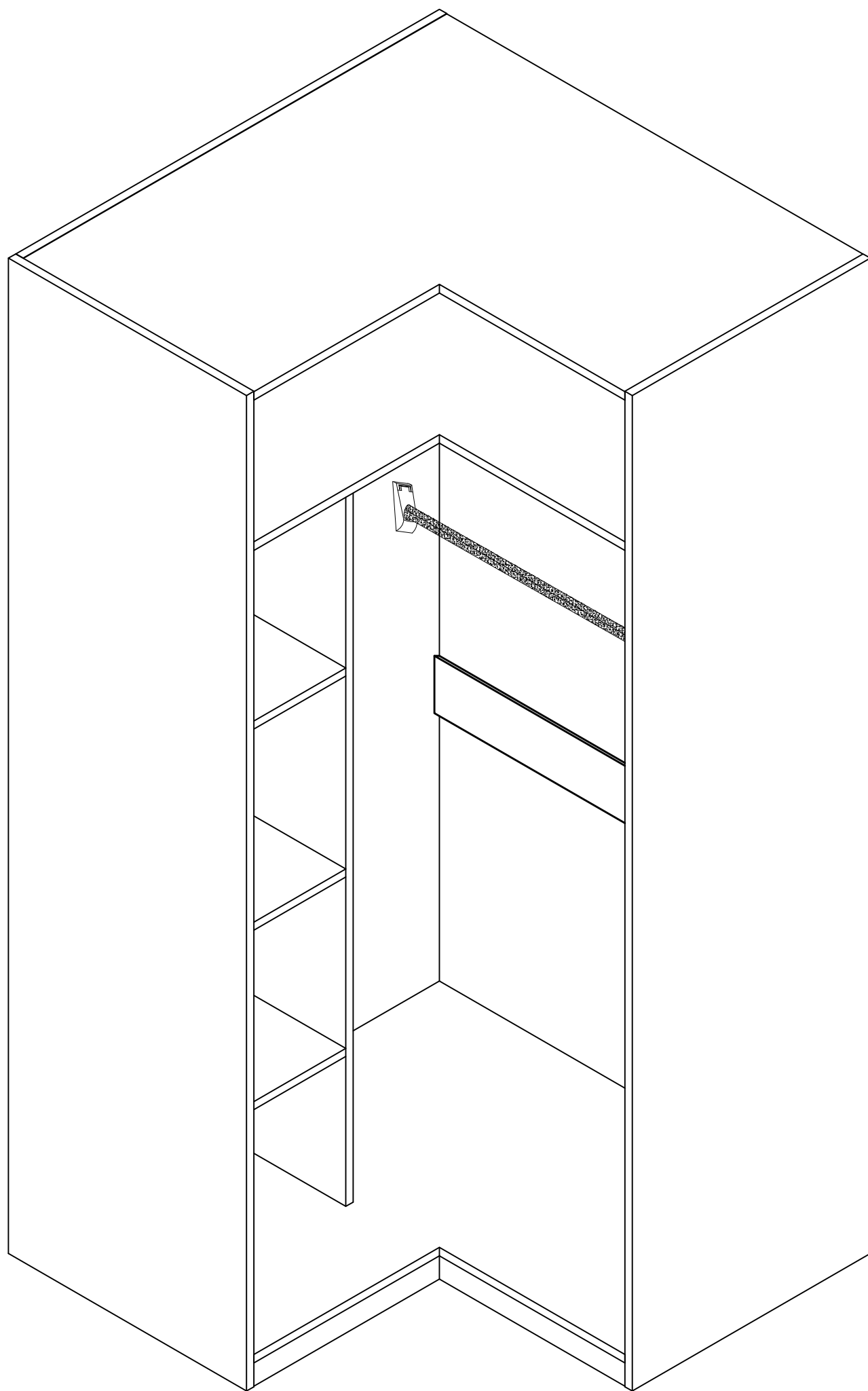

Tool Needed

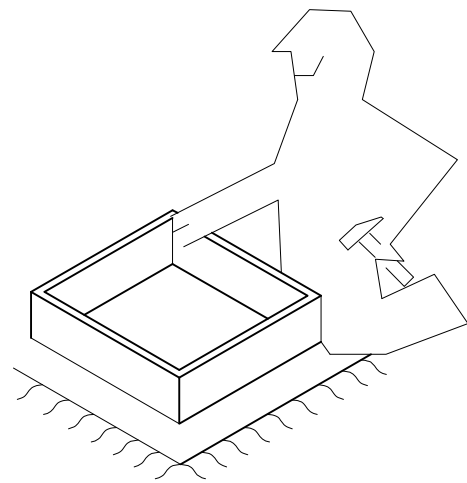
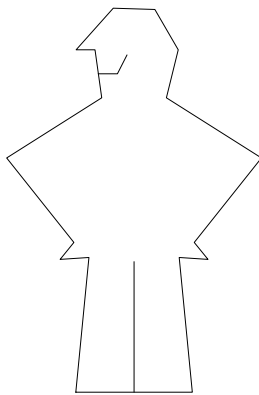
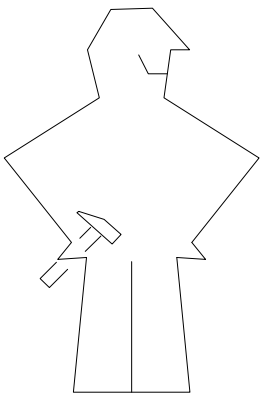
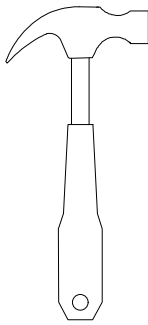
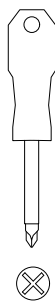
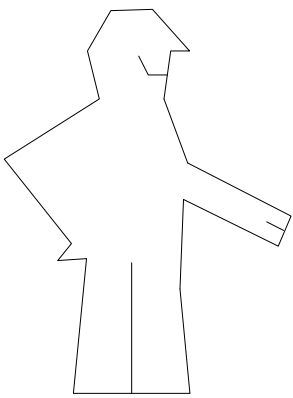

Two Man Work

Protection On Floor

Accessories Instruction

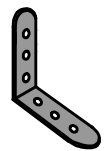
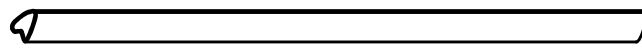
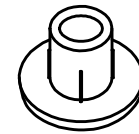
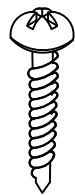
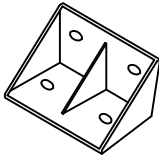
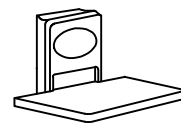
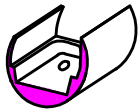
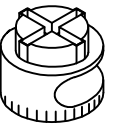
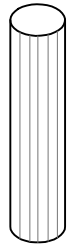

Size of each panel

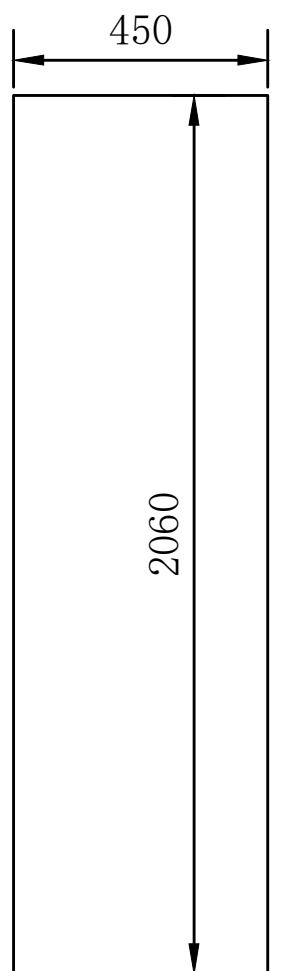
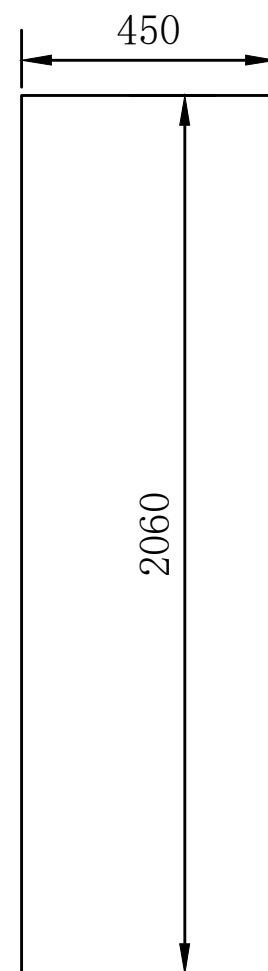
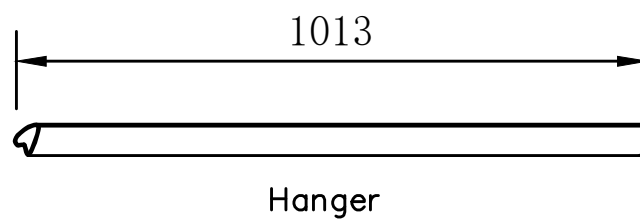
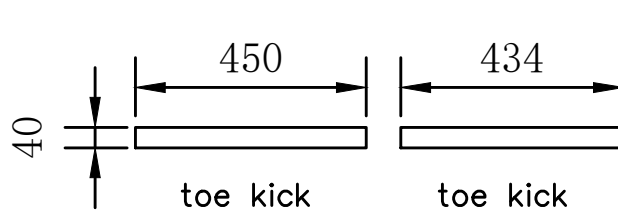
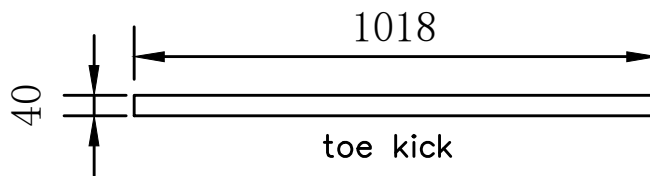
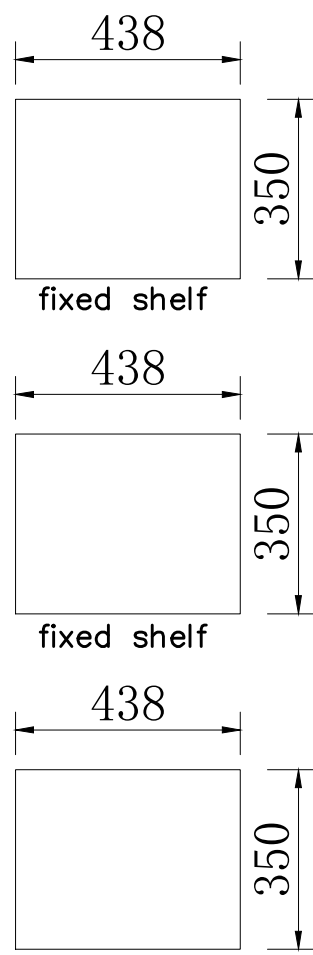
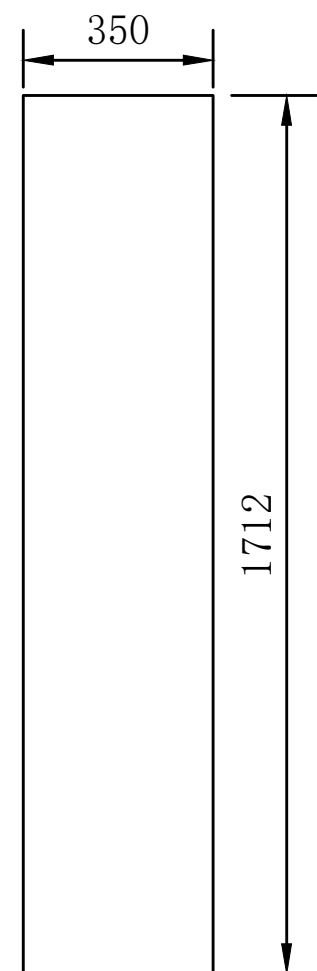
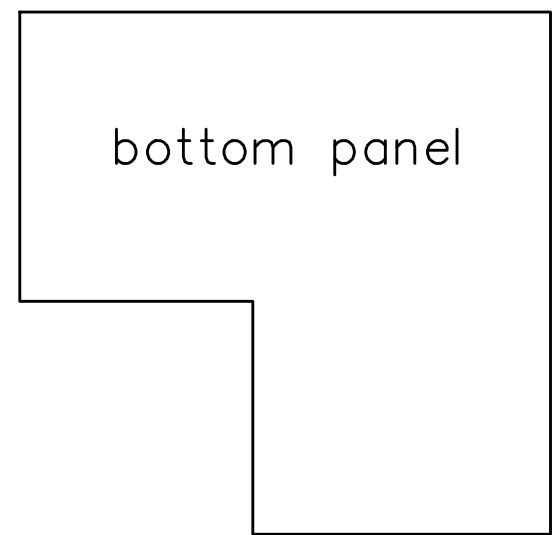
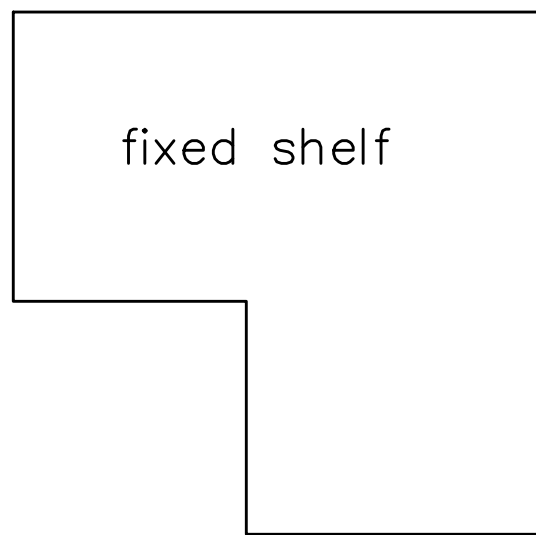
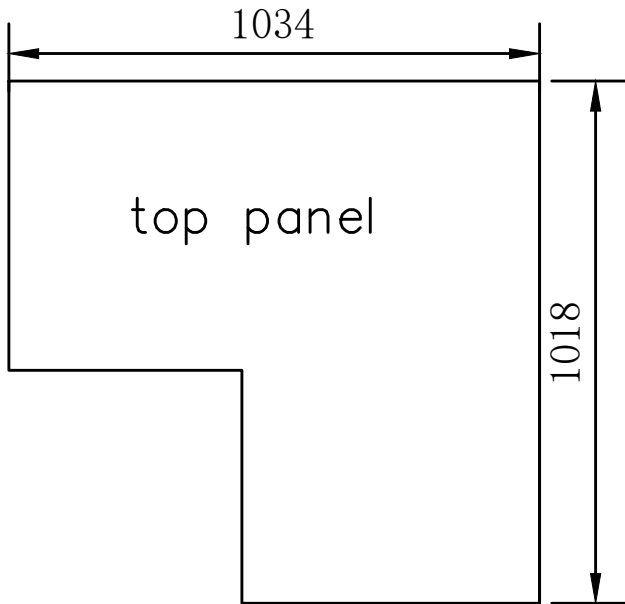
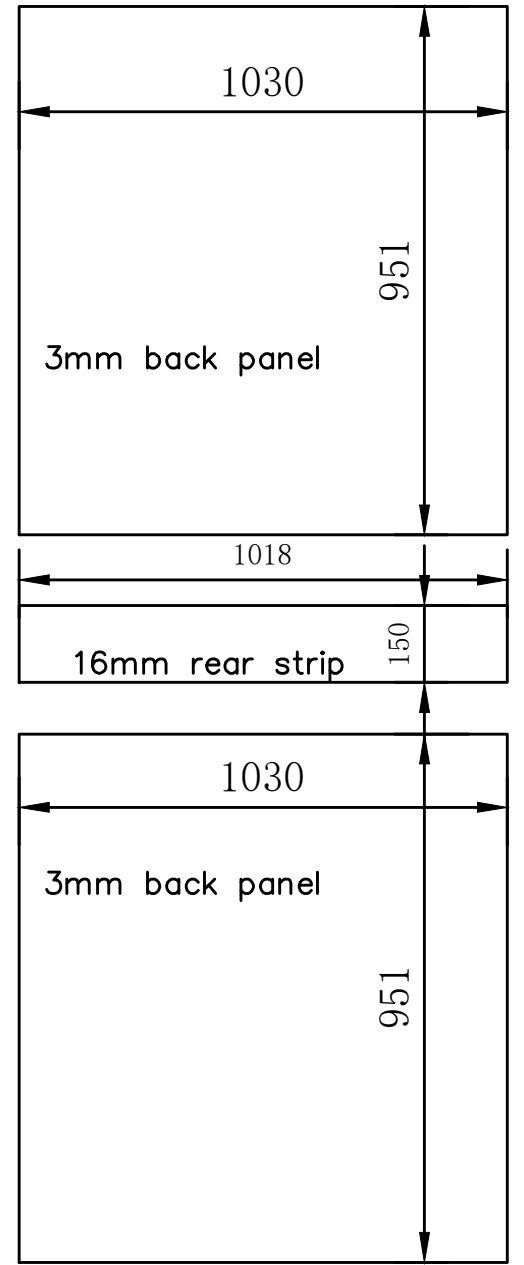
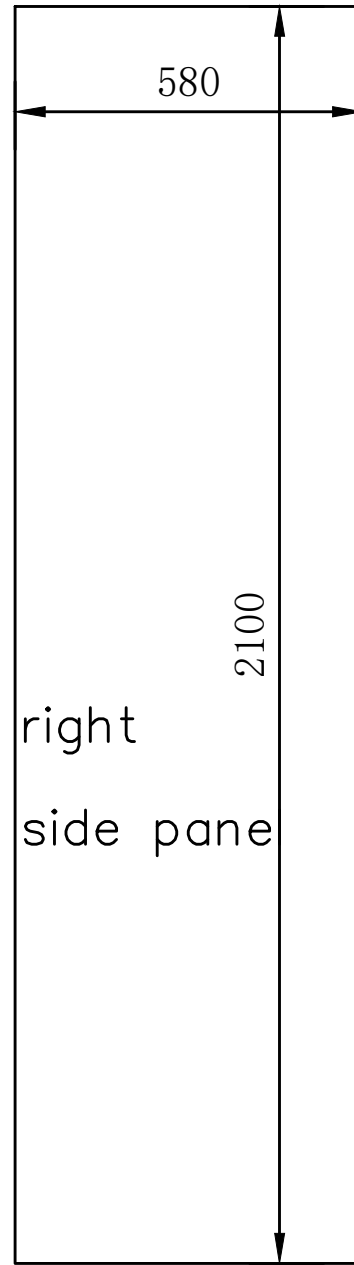
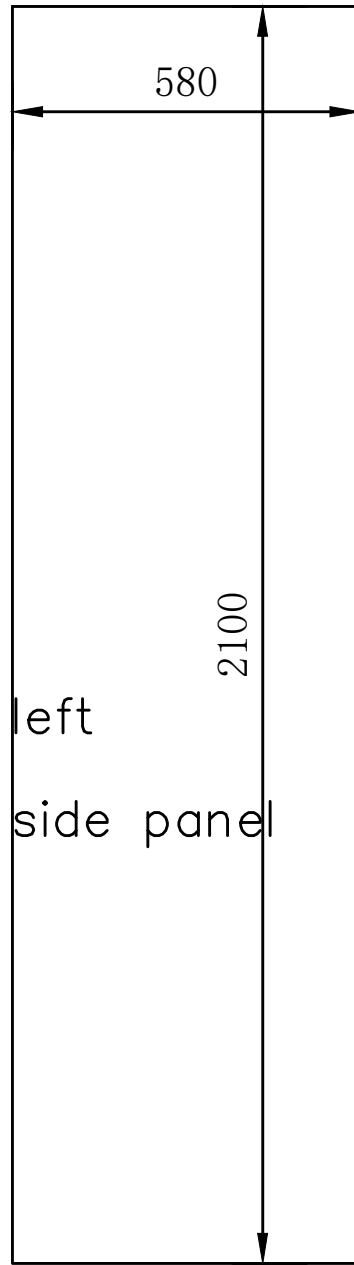
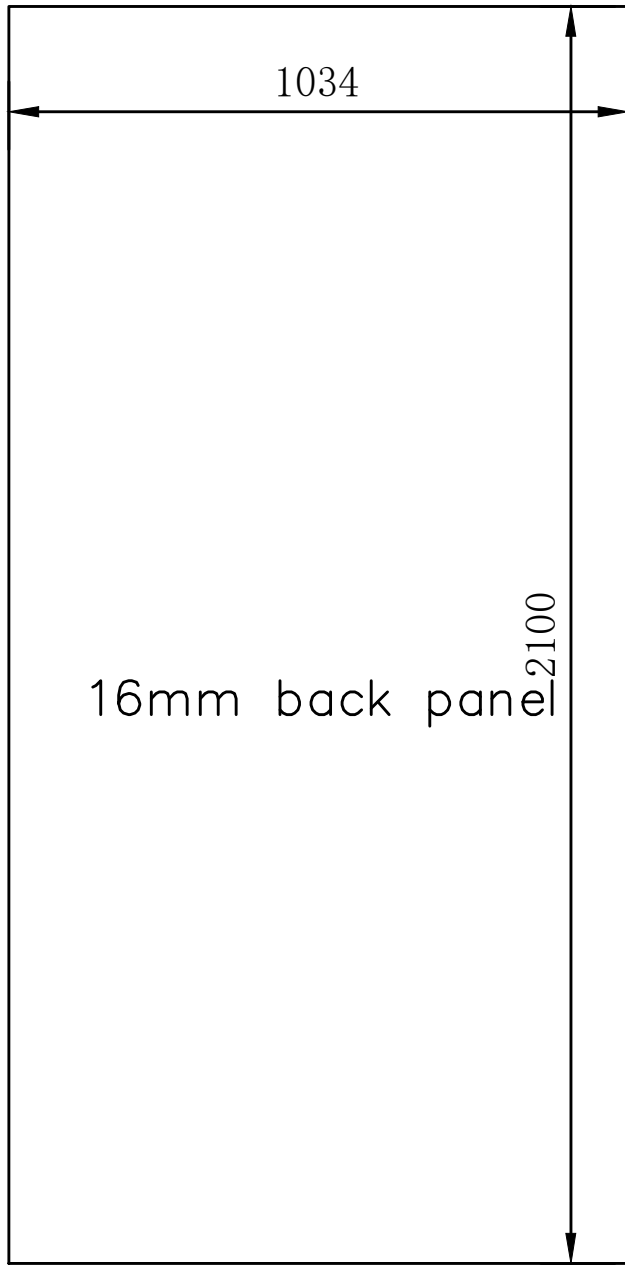

Opening hole location diagram

