



The Creative Life

- Before using your washing machine, please read this manual carefully and keep it for future reference.
- This manual shall also be available by sending E-mail to client.
- The drawings in this manual are for instruction only, it may vary from the model you buy.

WASHING MACHINE OWNER'S MANUAL

TCL Home Appliances(Hefei)Co.,Ltd.

Contents

Products Specification.....	2
Safety Precaution.....	3
Important Hints.....	5
Overview of Washing Machine.....	6
Install Washing Machine.....	7
Operate Washing Machine.....	11
Maintenance.....	20
Troubleshooting.....	23
Appendix.....	25
Products Fiche.....	27

PRODUCT REGISTRATION

Thank you for purchasing our TCL product. This easy-to-use manual will guide you in getting the best use of your washer. Inside you will find many helpful hints on how to use and maintain your washing machine properly. You'll find many answers to common problems in the chart of troubleshooting tips. Remember to record the model and serial numbers. They are on the back of the unit.

Model number

Serial number

Date of purchase

Products Specification

Parameter/Capacity	Inverter Motor Series
	8kg
Model	P608FLW
Voltage	220-240V~/50Hz
Rated Power	1900W
Water Pressure	0.05-0.8MPa
Outer Dimension (W*D*H) mm	595*520*850
Net(KG)	58

NOTE:

1. All the pictures in the manual are used for schematic only. It may be different from the machine you buy.
2. The actual function and the data in kind prevail.

WARNING

To reduce the risk of fire, electric shock, or injury to persons when using your appliance, follow basic precautions, including the following

- If the power cord is damaged, it must be replaced by the manufacturer, service agent or similarly qualified persons in order to avoid the hazard.
- The new hose-sets supplied with the washer are to be used and that old hose-sets should not be reused.
- This appliance is not intended for use by persons (including children) with reduced physical, sensory or mental capabilities, or lack of experience and knowledge, unless they have been given supervision or instruction concerning use of the appliance by a person responsible for their safety. Children should be supervised to ensure that they do not play with the appliance. (This warning is not for EUROPEAN market)
- This appliance can be used by children aged from 8 years and above and persons with reduced physical, sensory or mental capabilities or lack of experience and knowledge if they have been given supervision or instruction concerning use of the appliance in a safe way and understand the hazards involved. Children shall not play with the appliance. Cleaning and user maintenance shall not be made by children without supervision. (This warning is for EUROPEAN market)
- Carpet does not obstruct the opening for washing machine with ventilation openings in the base.
- Children of less than 3 years should be kept away unless continuously supervised.
- This appliance is intended to be used in household and similar applications such as:
 - staff kitchen areas in shops, offices and other working environments;
 - farm houses
 - by clients in hotels, motels and other residential type environments;
 - bed and breakfast type environments;
 - areas for communal use in blocks of flats or laundrettes.
- Take care that power voltage and frequency shall be identical to those of washing machine.
- To ensure your safety, power cord plug must be inserted into an earthed socket. Check carefully and make sure that your socket is proper and earthed reliably.
- Do not use any socket with rated current less than that of washing machine.
- Do not operate your washer when parts are missed or broken.
- Never pull out power plug with wet hands.

Safety precaution

- Replace immediately worn power cord, loose plugs/power sockets.
- Unplug your washer before cleaning or making any repair.
Please check whether the water inside the drum has been drained before opening the door. Please do not open the door if there is any water visible.
- Glass door may be very hot during the operation. Keep kids and pets far away from the washer during the operation.
- Make sure that the water and electrical device must be connected by a qualified technician in accordance with the manufacturer's instruction and local safety regulations.
- Before operating this machine, all packages and transit bolts must be removed. Otherwise, the washing machine may be seriously damaged while washing the clothes.
- Flammable and explosive or toxic solvents are forbidden. Gasoline and alcohol etc. shall not be used as detergents. Please only select the detergents suitable for machine washing.
- Be careful of scald while the washer draining hot washing water.
- Never unplug your washer by pulling on the supply cord. Always grasp the plug firmly and pull straight out from the outlet.
- If your old appliance is not being used anymore, we recommend that you remove the door and cut off the supply cord.
- Packing materials may be dangerous to the kids. Please keep all packing materials (plastic bags, foams etc) far away from the kids.
- Do not climb up and sit on top cover of the machine.
- Pets and kids may climb into the machine. Check the machine before every operation.
- Do not lean against the door of the washer.

Important Hints

- The household washing machine isn't intended to be built-in.
- This washing machine is for indoor using only.
- Make sure that all pockets are empty. Sharp and rigid items such as coin, brooch, nail, screw or stone etc. May cause serious damages to the washer.
- Please remember to disconnect water and power supply immediately after the clothes are washed.
- The washing machine shall not be installed in bath room or very wet rooms as well as in the rooms with explosive or caustic gases.
- Before washing the clothes at first time, the washing machine shall be operated in one round of the whole procedures without the clothes inside.
- Do not repair or replace any part of the washer unless you have been specifically recommended in the user-repair instructions and you have the knowledge and skills to make it.
- It is forbidden to wash carpets and bras inset with steel wire.
- Never refill water by hand during washing.
- After the program is completed, please wait for two minutes to open the door.
- When handing the machine, the accumulated water shall be drained out of the machine firstly. Handle the machine carefully. Never hold each protruded part on the machine while lifting. Machine door can not be used as the handle during the conveyance.
- The washing machine with single inlet valve only can be connected to the cold water supply. The washing machine with double inlet valves can be connected to the hot water and cold water supply.

SAVE THESE INSTRUCTIONS

THE MACHINE IS HOUSEHOLD USE ONLY

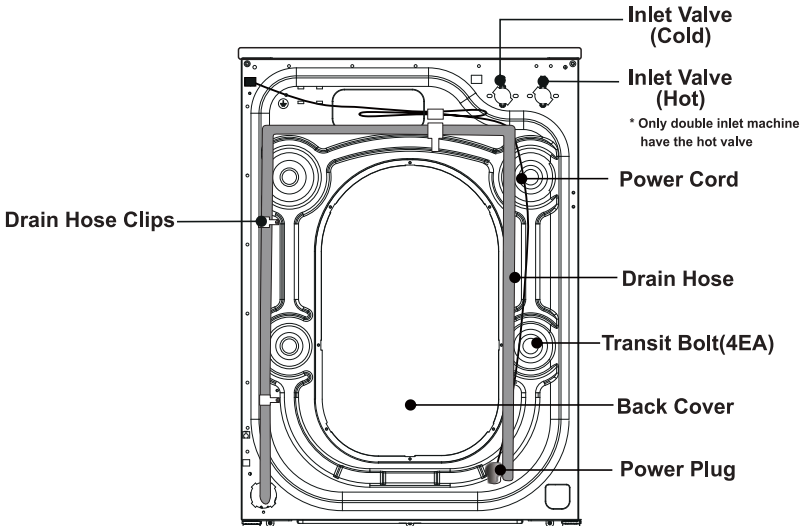
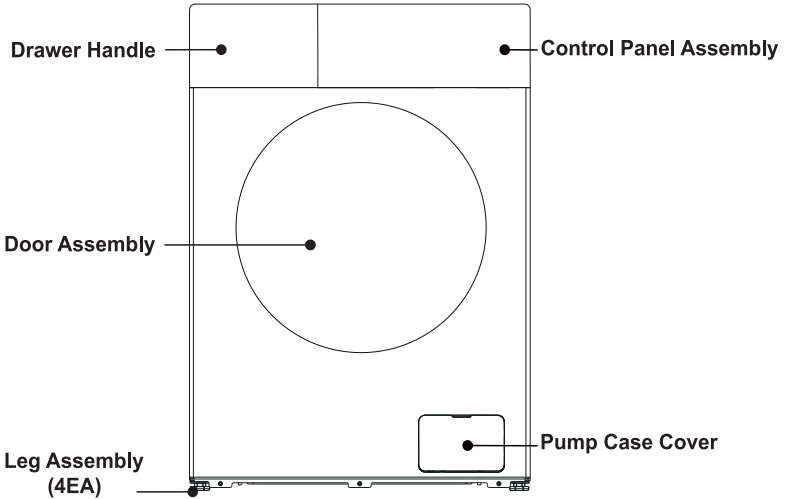

Install Washing Machine

NOTE

We recommend that your new washer should be installed by a qualified appliance technician. If you feel that you have the skills to install the washer, please read the installation instructions carefully before installing.

■ Tools needed





You may need to have the following tools to help you in the installation of your washer:

- Scissors
- Pliers
- Standard Screwdriver
- Gloves
- Spanner

■ Unpacking the washing machine

Unpacking your washing machine and check if there is any damage during the transportation. Also make sure that all the items (as shown below) in the attached bag are received. If there is any damage to the washing machine during the transportation, or any item is missing or damaged, please contact the local dealer immediately.

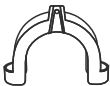
***If washing machine is not double inlet, the machine does not have the hot inlet hose.**

Inlet Hose (Connect to cold water supply)	Hot Inlet Hose (Connect to Hot water supply)	Hole Cover (4EA) (Used to plug transit bolt holes)	Drain Hose Support Bracket (Used to loop the end of drain hose)	Spanner (1. Used to adjust the bottom of the machine, 2. Remove the transport bolt on the back of the machine)
				

■ Select the location

Before installing the washer, the location characterized as follows shall be selected:

- Rigid, dry, and level surface (if not level, please make it level with reference to the following figure "Adjustable Leg").
- Avoid direct sun light.
- Sufficient ventilation.
- The ambient temperature shall be between 0-40°C.
- The ambient humidity shall be below 95% (When the temperature is 25°C).
- Keep far away from the heat resources such as coal or gas. Make sure that the washer will not stand on power cord. Do not install the washer on the carpet floor.

Install Washing Machine

■ Remove transit bolts

Before using this washing machine, transit bolts must be removed from the backside of this machine. Please take the following steps to remove the bolts:

⚠ Keep the transit bolts properly for further use.

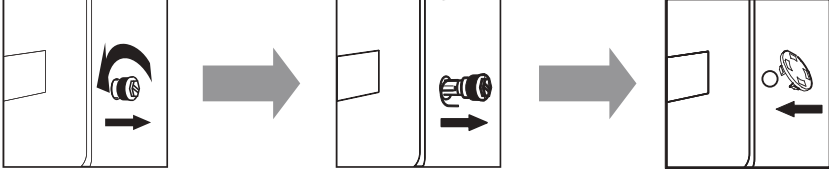

1. Loosen the four transit bolts with a spanner

2. Take each bolt head and pull it through the wide part of the hole. Repeat for each bolt.

3. Fill the holes with the supplied plastic covers.

■ Level the washing machine

Install or place the washing machine under the environmental temperature of not less than 0°C but not outdoors, for it may damage the programming controller.

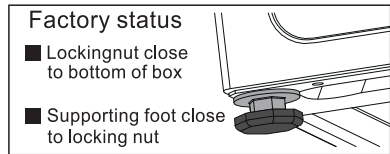
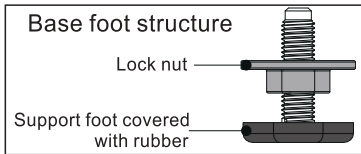

⚠ **Note:** In order to facilitate installation, the factory status of the foot may not be all locked, please be sure to lock all four feet before adjusting the level

1. When placing the machine, check whether the bottom foot is in the factory state. If not, please restore the bottom foot to the factory state: the locking nut is locked tightly on bottom of the box, and the support foot is locked tightly on the locking nut.

2. After the machine is placed, press the opposite corner of the top cover plate of the washing machine with both hands to turn and shake it vertically downward to check whether the supporting foot is close to the ground and whether the machine is shaken.

3. To ensure that the machine is placed in the right state, loosen the locking nut according to the direction shown in the diagram with the attached spanner to the appropriate height until the supporting foot is close to the ground and the machine is free from shaking.

4. Finally, use the spanner to turn the lock nut back to the bottom of the box to lock it (you can also slightly fix the support foot by hand to avoid the support foot moving again).

⚠ CAUTION

1. The machine must be perfectly leveled and stabilized when the four supporting feet are close to the ground. Lower the feet as much as possible on the basis that the machine is leveled.
2. Improper leveling adjustment may cause loud noise, machine vibrating, machine displacement and other abnormal phenomena.
3. Air-vent is designed on the bottom of the machine (prevent blockage). Install the washing machine on solid, smooth and skid-proof ground. Do not place the washing machine on soft blanket or wooden floor, or various desktops and stands, in case of unnecessary injury.

Install Washing Machine

The provided water hose may differ depending on the model. Please follow the instruction according to the provided water hose.

■ Connect the inlet hose

Connecting to a threaded water tap

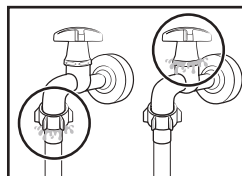
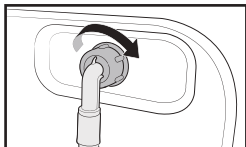
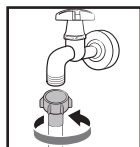

1. Connect the water hose to the water tap, and then turn the connector clockwise as shown.
2. Connect the other end of the water hose to the inlet valve on the back of the washing machine. Turn the hose clockwise to tighten.
3. Open the water tap and check if there are any leaks around the connection areas. If there are water leaks, repeat the steps above.

Connecting to a non-threaded water tap

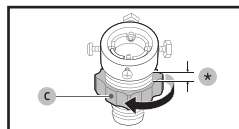
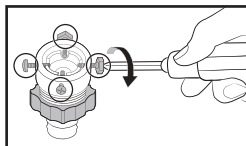
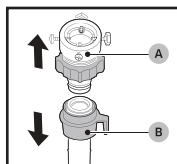

1. Remove the **adaptor (A)** from the water **hose (B)**.
2. Use a Phillips screwdriver to loosen four screws on the adaptor.
3. Hold the adaptor and turn **part (C)** in the arrow direction to loosen it by 5mm (*).

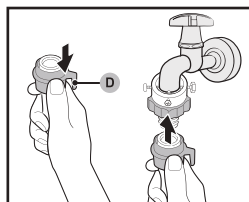
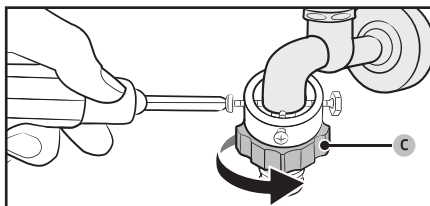

4. Insert the adaptor onto the water tap, and then tighten the screws while lifting the adaptor.
5. Turn **part (C)** in the arrow direction to tighten it.
6. While pulling down **part (D)** on the water hose, connect the water hose to the adaptor. Then, release **part (D)**. The hose fits into the adaptor with a clicking sound.
7. To complete connecting the water hose, see 2 and 3 on the "Connecting to a threaded water tap" section.

Install Washing Machine

NOTE

- If there is any leakage with hose after the connection, then repeat the steps to connect inlet hose.
- Do not bend the hose.
- Check for inlet hose connection carefully before using the washer each time.

■ Connect the drain hose

- The drain hose shall be placed at a height of 65-100cm above the floor, otherwise, it can cause poor drainage.
- You can use the supplied drain hose support bracket to loop the drain hose down into the wall, standpipe or laundry tub.
- Take care to ensure all hose connections are tight.

NOTE

- The end of the drain hose cannot be immersed in water for the washer to work properly.

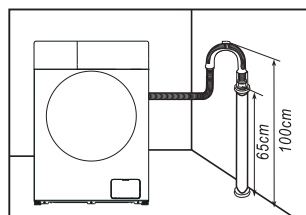
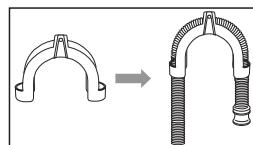
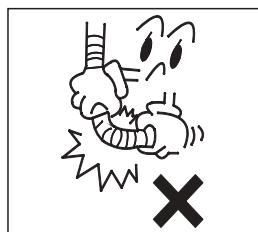

■ Connect the power

- As the maximum current through the unit is 10A when you are using its heating function, please make sure the power supply system (current, power voltage and wire) at your home can meet the normal loading requirements of the electrical appliances.
- Please connect the power to a socket which is correctly installed and properly earthed.
- Make sure the power voltage at your plate is same to that in the machine's rated voltage.
- Power plug must match the socket.
- Do not use multi-purpose plug or socket as extension cord.
- Do not connect and pull out plug with wet hands.
- When pulling out the plug, hold the plug tightly and then pull it out. Do not pull power cord forcibly.
- If power cord is damaged or has any sign of being broken, special power cord must be selected or purchased from its manufacturer or service center for replacement.

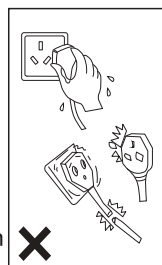

WARNING

1. This machine must be earthed properly. If there is any short circuit, earthing can reduce the danger of electrical shock.
2. Washing machine shall be operated in a circuit separate from other electrical appliances. Otherwise, power protector may be tripped or fuse may be burned out.

Operate Washing Machine

NOTE

Ensure your machine is installed properly before use.

Before washing clothes for the first time, you must run a complete cycle without clothes.

To do this:

1. Connect power source and water.
2. Put a little detergent (about 10g) into the drawer and close it.
3. Press the **On/Off** button.
4. Turn the knob to be “Cotton” program.
5. Press the **Start/Pause** button.

This will remove any water from the manufacturer's test run remaining in the machine.

Sort clothes

Please read this recommendation carefully to avoid the troubles of washing machine and damages of clothes.

1. Do not put clothes over load the rated capacity.
2. Sort the laundry by colour and by care label. Most garments have a textile care label in the collar or side seam.
3. Make sure all the pockets are empty, Foreign objects (e.g. nails, coins, paper clips, etc.) can cause damage to garments and components in the machine.
4. Close any zips, fasten hooks etc. before washing.
5. For clothes to be washed, they should be sorted according to color. Dark clothes should not be washed with light clothes especially.
6. Badly soiled areas, stains etc. should be pre-treated with liquid detergent, stain removers etc.
7. Turn over the clothes which pill easily and is with woolen surface before putting them into the machine.

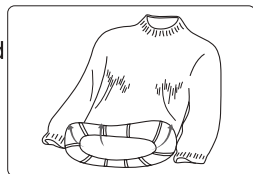
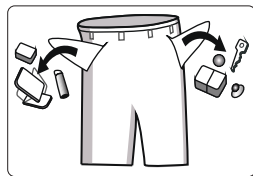

NOTE: Make sure that no clothes is caught between the door and the seal.

Put detergent

- Pull out the detergent drawer.
- Add detergent for prewash into compartment I. Used only for prewash programs. (option1: detergent that is solid; option2: detergent that is liquid.)
- Add detergent for main wash into compartment II. (option1: detergent that is solid; option2: detergent that is liquid.)
- Add fabric softener into compartment III.

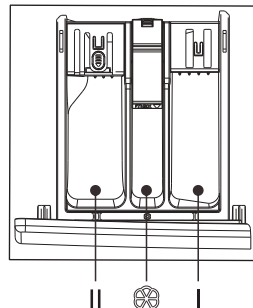

Operate Washing Machine

- Please choose suitable type of detergent for the various washing temperature to get the best washing effect with less water and energy consumption.
- The amount of detergent/softener used should be added only once at a time. Please refer to the manufacturer's instructions for the dosage of detergent/softener.
- Excessive detergent will produce a lot of foam, easy to overflow, and will affect its dissolution, resulting in rinsing difficulties.

Detergent Release(automatically release)

Use Liquid Detergent (Automatically)

You could add liquid detergent in box ① before washing. During operation, washing machine would add liquid detergent automatically according to the weight. It can achieve manually add once, smartly, accurately and automatically add for several times.

Use Washing powder or Softener(Manually)

If you would like use washing powder or softener, please push the button to close automatically add function. (The LED indicator will now be OFF) Choose non-foaming or low-foaming detergent, which are suitable for front loading washing machines.

Everytime put once washing machine quantity, which could refer to manual.

Over-loading washing powder could generate a lot of bubbles. It causes difficulties for washing because of the influence of powder's dissolution.

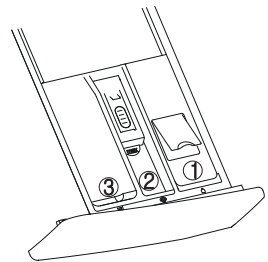

- ① liquid detergent box: liquid detergent
- ② softener box: liquid softener
- ③ washing powder box: powder or liquid detergent

⚠ NOTE

1. At the first time using liquid detergent and automatically release function, please operation "Super Quick" program to washing tube and drum.
2. It is normal that a few liquid detergent flow into down-water box when pulling liquid detergent box. Please avoid pull the box frequently to decrease the cost of liquid detergent.
3. The quantity of softener please refer to manual. Over-loading softener would destroy artificial fiber.
4. Liquid level do not over the MAX of Distributor box.
5. Please dilute the thick softener or bleach first and then release in distributor box.

Operate Washing Machine

■ Washing steps

① Connect inlet hose and turn on the tap



② Insert power plug

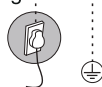

③ Place drain hose



④ Open the door, put in clothes and shut it down; put detergent in detergent case and close the case;

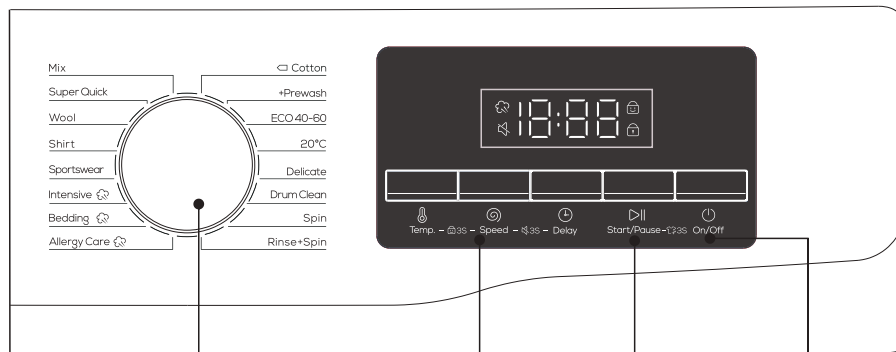

⑥ Select program as needed

⑦ Customize settings like delay time, temperature, spin rate other Settings, etc.

⑧ Press down Start button.

⑤ Press down power key

- Press Power **On/Off** to turn on the washing machine.
- Turn the Cycle Selector to select a cycle.
- Change the cycle settings (Temperature and Speed, etc.) as necessary.
- Set Time Delay if you want to finish the wash cycle at the desired time.
- Press **Start/Pause**.

To change the cycle during operation

- Press **Start/Pause** to stop operation.
- Select a different cycle.
- Press **Start/Pause** again to start the new cycle.

Operate Washing Machine

■ Control panel

* The following illustration is a simple example of the model control panel. The illustration is for reference only. Please refer to the actual effect.

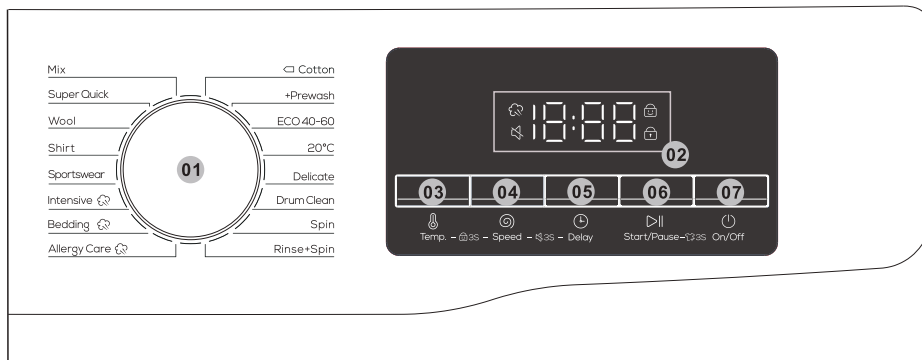

01 Cycle Selector	Turn the dial to select a cycle.
02 Display	The display shows current cycle information and estimated time remaining, or an information code when a problem occurs.
03 Temp.	Press to change the water temperature for the current cycle. Available temperature range depends on the cycle. The selected temperature will be displayed on the display.
04 Speed	Press to change the spinning speed for the current cycle. Available spin speed depends on the cycle. The selected spin speed will be displayed on the display.
05 Delay	Press Delay repeatedly to cycle through the available Delay options (from 3 to 24 hours in one hour increments).
06 Start/Pause	Press to Start/Pause operation. Press the button once to start a cycle. To pause operation, press the button again. You may change the cycle settings and options. To resume paused operation, press the button again.
07 On/Off	Press to turn On/Off the washing machine. If you turn on the washing machine and do not use it for 10 minutes, it will turn off automatically.

Operate Washing Machine

Delay

You can set the washing machine to finish your wash automatically at a later time, choosing a delay of between 3 to 24 hours (in 1 hour increments). The hour displayed indicated the time the wash will finish.

1. Select a cycle. Then change the cycle settings if necessary.
2. Press **Delay** repeatedly until a desired end time is set.
3. Press **Start/Pause**.

The corresponding indicator turns on with the clock running.

4. To cancel the **Delay**, restart the washing machine by pressing **On/Off**.

Real-life case

You want to finish a two-hour course 3 hours later from now. For this, you add the Delay option to the current cycle with the 3-hour setting, and press **Start/Pause** at 2:00 p.m. Then, what happens? The washing machine starts operating at 3:00 p.m., and ends at 5:00 p.m.

Steam Wash Icon

If this icon is always bright, it means the Steam Wash function is enabled. Due to the different configuration of models, some models do not have this configuration, please refer to the actual model.

Child Lock

To prevent accidents by children, Child Lock locks all buttons except for **On/Off**.

- To activate or deactivate the Child Lock function, press and hold **Temp.** and **Speed** simultaneously for 3 seconds.

When Child Lock is activated, the indicator  lights up.

Alarm Off

You can turn on or off the sound of the cycle selector and all buttons.

- To turn on or off the sound, press and hold **Speed** and **Delay** simultaneously for 3 seconds. When the sound is off, the  indicator lights up.

Door Lock

When the door is not closed or locked normally, the icon is not bright; Lock the door correctly, the icon is always bright.

Reload

Long press the **Start/Pause** button for 3 seconds. After the lock is unlocked, the function of adding clothes in the middle can be started.

Operate Washing Machine

■ Programe

Mix: For mixed load consisting of cotton and synthetic.

Super Quick: For lightly soiled garments in less than 2.0 kg that you want to wash quickly.

Wool: The wool course features gentle cradling and soaking to protect the wool fibres from shrinkage/distortion. A neutral detergent is recommended.

Shirt: You can select this procedure to wash shirts made of cotton, linen, synthetic fibers or blended fabrics.

Sportswear: This procedure is applicable to the cleaning of sportswear.

Intensive: For heavily soiled items. The operation time is longer than other cycles.

Bedding: This procedure is suitable for washing heavier clothes. Jeans, bedding, etc.

Allergy Care: Featuring a high-temperature wash and extra rinses to help remove the remaining detergent effectively.

□ **Cotton:** For cottons, bed linens, table linens, underwear, towels, or shirts. The washing time and the rinse count are automatically adjusted according to the load.

+ **Prewash:** Add a preliminary washing process before starting the Cotton cycle.

ECO 40-60: For cleaning normally soiled cotton items which are declared to be washable at 40 °C or 60 °C, together in the same cycle.

20°C: New European standard special procedures, used for washing some gentle clothes, the temperature can only choose 20°C, protective clothing.

Operate Washing Machine

Delicate: For sheer fabrics, bras, lingerie (silk), and other handwash-only fabrics. For best performance, use liquid detergent.

Drum Clean: Cleans the drum by removing dirt and bacteria from it. Make sure the drum is empty. Do not use any cleaning agents for cleaning the drum.

Spin: Featuring an additional spin process to effectively remove moisture from laundry.

Rinse + Spin: Featuring an additional rinse process after applying fabric softener to the laundry.

■ Circuit Diagram

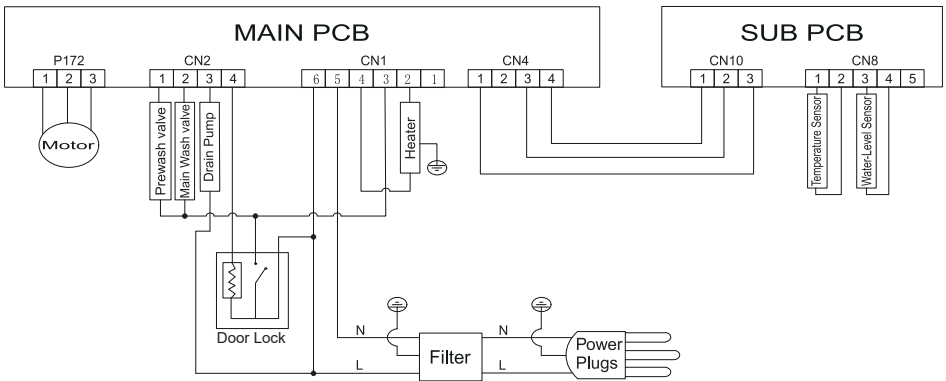

Operate Washing Machine

■ Table of Washing Procedures

- Washing efficiency and performance is determined by used detergent quality. Use only machine wash approved detergent.
- If need use specific detergent, e.g. for synthetic and woolen fabric. Mind always detergent manufacturer recommendations.
- Do not use dry cleaning agents such as trichloroethylene and similar products. Choose the best detergent.

Program	Max Load (kg)					Kind of detergent		
	6	7	8	9	10	Universal	Special	Softener
Mix	3	3.5	4	4.5	5	L/P	-	○
Super Quick	2	2	2	2	2	L/P	-	○
Wool	1.5	2	2	2	2	-	L/P	-
Shirt	2	2.5	3	3.5	4	L/P	L	○
Sportswear	2	2.5	3	3.5	4	L/P	-	○
Intensive ☁	6	7	8	9	10	L/P	-	○
Bedding ☁	4	5	6	7	8	L/P	L/P	○
Allergy Care ☁	3	3.5	4	4.5	5	L/P	L/P	○
□ Cotton	6	7	8	9	10	L/P	-	○
+ Prewash	4	5	6	7	8	L/P	-	○
ECO 40-60	6	7	8	9	10	L/P	-	○
20°C	3	3.5	4	4.5	5	L/P	-	○
Delicate	3	3.5	4	4.5	5	L/P	L/P	-
Drum Clean	0	0	0	0	0	-	-	-
Spin	6	7	8	9	10	-	-	-
Rinse + Spin	6	7	8	9	10	-	-	○

L=gel-/liquid detergent P=Powder detergent O=optional -=no

If using liquid detergent, it is not recommended to activate the time delay.

We recommend by using: Laundry powder 20°C to 95°C; Wool detergent 20°C to 40°C;

*Choose 95°C wash temperature only for special hygienic requirements.

Operate Washing Machine

■ Introduction of Other Functions

Unlock of emergency door (not applicable in some models)

- If you want to take out the clothes when there is a long-time power cut, make sure the water level in the drum is below the safe level, the temperature is under 40°C, and the inner drum is does not rotate, then detach the drain hose and lower it, replace the hose after water runs out;
- Open the drain pump cover at the bottom right of the front side, pull down the rod lightly, when hearing a light sound then open the door and take out or put in the clothes;
- Replace drain pump cover;
- This method can only be used in emergency.

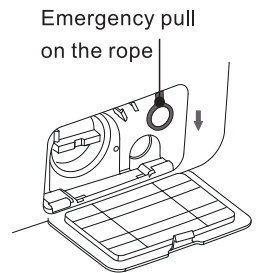

Auto Dispensing (not applicable in some models)

- This machine can dispense the laundry detergent automatically. When you want to use the powder detergent by yourself, please turn off the combination button to stop this function;
- When you start the machine, if the indicator light shows full, it means the detergent is abundant; when the washing finishes, if there is only one bar of the light left, and it shows “□□□□” for the service time, it means the detergent is running out, then you need to add the detergent.
- Before the washing, you can put the detergent in the detergent case, then the machine will dispense the detergent according to the weight of the clothes in the process of washing automatically.
- Please find the process table for further information of the default state for this function.

Resume Function

- This machine has the resume function in case of power-down. If there is a power failure or plug loose in the process of machine, the machine can remember the working status and resume work when the power is restored.

Memory Function (not applicable in some models)

- This machine can remember the latest working process automatically. When you turn on the machine again, the machine remembers the washing process and the settings you made last time (it means the whole working process of the latest washing will be selected by default when the machine starts)

Cloth Weigh Awareness

- In the beginning of the washing, the machine will estimate the weight of the clothes and dispense the detergent automatically (on condition that there is enough detergent in the case), then decide the amount of the water accordingly to achieve the goal of saving water.

Operate Washing Machine

Unbalance Protection

- When the machine is ready to spin, The washer may take a few time to balance clothes due to great unbalance.
- If clothes is still unbalance in the drum after that, the spinning speed can be slow down to avoid great vibration.
- If clothes in drum is too less, the machine may not to spin due to the unbalance protection, then you should add more clothes in the machine to make it to spin.

Sprinkling (not applicable in some models)

- This machine adopts detergent auto dispensing technology; water will flow out from the detergent case to delivery detergent into inner drum. It will also spray water on the glass of observation window, which has better effect of cleaning the foam and stains on the clothed and window. This will make washing process cleaner and construct a high efficient, water-saved and clean washing environment!

Drum lamp (not applicable in some models)

- At the beginning of the program, at the end of the program and at the pause of the washing state, the lamp of the washing machine cylinder will be lit. You can observe the situation of the clothes in the washing machine and feel the fun of smart laundry.

Note: Due to the product model upgrade, the function configuration may be different from this description, please take the actual model function as the standard!

Maintenance

Proper maintenance on the washing machine can extend its work life.



Before your maintenance starts, please do pull out the power plug or disconnect power and close the tap.

■ Clean internal drum

The rusts left inside the drum by the metal articles shall be removed immediately with chlorine-free detergents. Never use steel wool.

■ Clean surface

- 1.If there is any water overflow, use the dry cloth to wipe it off immediately. No sharp items are allowed to strike the washer.
- 2.The surface can be cleaned with diluted non-abrasive neutral detergents when necessary.

Maintenance

■ Clean the drain pump

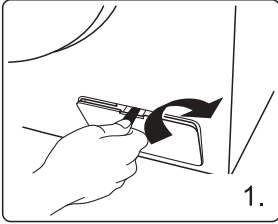

Open the filter cover with tools such as coins according to the direction of the graphic;



Unscrew the filter and pay attention to the remaining water, taking out any foreign material from the drain pump filter;

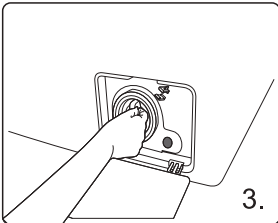
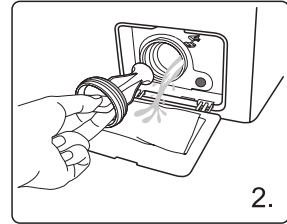

Reinstall the filter.

■ Clean Inlet valve filter

The inlet filter shall be cleaned if there is not any or insufficient water in when the tap is opened.

1. Lower the water pressure:

a. Close the tap.

b. Select any procedure except "Spin" procedure.

c. Press the button "Start / Pause" and keep the procedure running for about 40 seconds.

d. Pull out the power plug.

2. Remove the inlet hose from the tap.

3. Use water to wash the filter.

4. Reconnect the inlet hose.

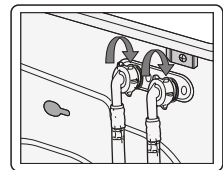
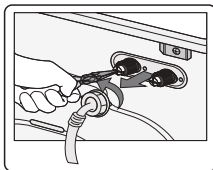
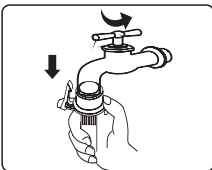

Maintenance

■ Clean detergent drawer

The structure of detergent case varies from different machine models; please follow steps and methods shown in below figure to clean the detergent case:

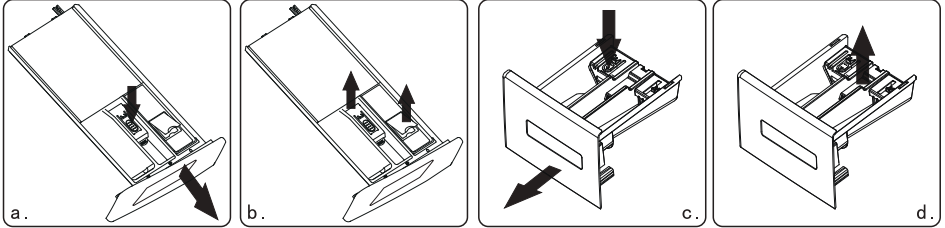

Auto dispenser

Common dispenser

■ If there is detergent or softener residue in the case:

- ◆ As fig. a(c) shows, pull the case and press down the limit rod; pull the whole drawer out;
 - ◆ As fig. b(d) shows, open the case (pick it up slowly) and take out syphon plate (lift it up);
 - ◆ Use tap water or brush to wash detergent case and syphon pipe;
 - ◆ Restore case cover and syphon pipe, and push the drawer in.
- A little detergent will flow into water box when drawing the case, this is normal.

Try not repeatedly opening and closing the case of detergent loss;

■ Pay attention to the spillover of detergent that may cause inconvenience when adjusting (like tilting and moving, etc.) the machine (draw out the case before adjusting).

■ Recovery from freezing

The washing machine may freeze when it drops below 0°C.

1. Turn off the washing machine, and unplug the power cord.
2. Pour warm water over the water tap to loosen the water hose.
3. Disconnect the water hose, and soak it in warm water.
4. Pour warm water into the drum and leave it for about 10 minutes.
5. Reconnect the water hose to the water tap.

▲ NOTE

1. When the washing machine is reused, make sure the ambient temperature is above 0°C.
2. If your washing machine is located in the room where it can get frozen easily, please drain the remaining water inside drain hose and inlet hose thoroughly.
3. Please contact a technician if your washer is frozen.

Troubleshooting

TROUBLES

SOLUTIONS

There is some remaining water in the machine



This is normal and is the result of water tests performed at the factory.

The washer does not run



Check if the power plug is inserted well.
Check if the tap is opened.
Check if the button "Power" is pressed.
Check if the button "Start/Pause" is pressed.
Check if the delay feature is activated.

Water leakage



Check and fasten inlet hose.
Clean up drain hose and ask a specialized person to repair it when necessary.

Abnormal noise and great vibration



Check if the transit bolts has been removed.
Check if the adjustable legs are adjusted level.
Check if the washer is installed on the solid and level floor.
Check if there are any barrettes or metal articles inside.

Washing efficiency is not satisfied



Select a proper procedure.
Add the proper detergent quantity according to the instructions in detergent package.

The machine take no answer after press buttons



Check if the "Child-lock" feature has been activate.
Press button "Start/Pause" first then press other buttons.

Actually running time of procedures is not corresponded to the display time



Check if clothes in the drum is dispersive enough.
Check if the water is drain out or inflow well.

The washer fills while draining



Check if the max height of the drain hose is lower than 65cm.
Check if the drain hose is immersed.

Troubleshooting

























DISPLAY	MEANS	SOLUTIONS
E1	The washer fills over time	Check if the tap is opened. Check if the water pressure is too low. Check if the inlet hose is blocked.
E2	Water drainage over time	Check if the drain pump is blocked. Contact a technician if necessary.
E3	Door lock is breakdown	Close the door well again. Check if the clothes is caught between the door and seal. Contact a technician if necessary.
E4	Water is overflowed	water automatically until the water level is suitable for wash procedure. Contact a technician if necessary.
E5	The electrical motor is breakdown	Please contact a technician.
E6	The heater does not work	Please contact a technician.
E7	There is a temperature sensor fault	Please contact a technician.
E8	Unmatched software/hardware on mainboard and frequency inverting plate	Please contact a technician.
E9	communication failures	Please contact a technician.
E10	Inverter failures	Please contact a technician.
EP	The procedure running is not corresponded to the cycle that the knob points.	Turn the cycle selector to the cycle corresponded to the procedure working on.

Note:

Please refer to the actually purchased model for fault display here. Different models have different fault displays.

Appendix

■ Fabric Care Lable

	Resistant material		Can be ironed at 100°C max
	Delicate fabric		Do not iron
	Item may be washed at 90°C		Can be dry cleaned using any solvent
	Item may be washed at 60°C		Dry clean with perchloride, lighter fuel, pure alcohol or R113 only
	Item may be washed at 40°C		Dry clean with aviation fuel, pure alcohol or R113 only
	Item may be washed at 30°C		Do not dry clean
	Item may be hand washed		Dry flat
	Dry clean only		Can be hung to dry
	Can be bleached in cold water		Dry on clothes hanger
	Do not bleach		Tumble dry, normal heat
	Can be ironed at 200°C max		Tumble dry, reduced heat
	Can be ironed at 150°C max		Do not tumble dry

■ Electrical Warning

To avoid fire, electrical shock and other accidents, please remember the following reminding:

- Only the voltage indicated in power label can be used. If you are not clear of the voltage at home, please contact the local power bureau.
- When you are using the heating function, the maximum current through the washing machine will reach 10A. Therefore, please make sure the power supply units(current, voltage and cable) can meet the normal laod requirements for the machine.
- Protect the power cord properly. Power cord shall be fixed well so that it will not trip the people or other things and be damaged. Special attention shall bepaid to the plug location.
- Do not make the wall-mounted socket overloaded or cable extended. Over loading of the wiring may cause fire or electrical shock. Do not pull out power plug with wet hand.
- To ensure your safety, power plug shall be inserted into an earthed socket. Carefully check and ensure that your socket is properly and reliably earthed.

Appendix

■ Protecting the environment

- The washer is manufactured by recyclable materials. If you decide to dispose of this washer, please observe the local waste disposal regulations. Cut off the power cord so that the washer cannot be connected to power. Remove the door so that small animals and children cannot get trapped inside the washer.
- Do not exceed the detergent quantities recommended in the detergent manufactures' instruction.
- Use stain removal products and blesches before the wash cycle only when strictly necessary.
- Save water and electricity by only washing full loads(the exact amount depends upon the program used).
- Correct Disposal of this Product



This marking indicates that this product should not be disposed with other household wastes throughout the EU. To prevent possible harm to the environment or human health from uncontrolled waste disposal, recycle it responsibly to promote the sustainable reuse of material resources. To return your used device, please use the return and collection systems or contact the retailer where the product was purchased. They can take this product for environmental safe recycling.

⚠ NOTE:

1. The energy efficiency rating was tested under “□Cotton” procedure (Adjuted at 40°C and 60°C+Maximum RPM)
2. For the purpose of improving the performance of the whole washing machine, the appearance and specifications shall be changed without additional notice.

Products Fiche

Brand: TCL
Model: P608FLW

Rated capacity: 8.0kg
Energy efficiency class: A+++
EU Ecolabel: N/A

Energy consumption 194 kWh per year, based on 220 standard washing cycles for cotton programmes at 60°C and 40°C at full and partial load, and the consumption of the low-power modes. Actual energy consumption will depend on how the appliance is used.

Water consumption 10780 litres per year, based on 220 standard washing cycles for cotton programmes at 60°C and 40°C at full and partial load, Actual water consumption will depend on how the appliance is used.

Spin-drying efficiency class B on a scale from G (least efficient) to A (most efficient).

Maximum spin speed: 1400rpm
The moisture content: 53%
Consumption values:

Standard Programme	Load	Energy consumption	Water consumption	Programme time
Cotton 60°C	8.0kg	0.98kWh	54.0L	285min
Cotton 60°C	4.0kg	0.78kWh	45.0L	265min
Cotton 40°C	4.0kg	0.77kWh	45.0L	255min

Note:

The actual parameters will depend on how the appliance is used, and maybe different with the parameters in above mentioned table.

The household washing machine is equipped with a power manager system.

The duration of the left-on mode is: 10min
Power consumption of off-mode: 0.5W
Power consumption of left-on mode: 1.0W
Airborne acoustical noise (washing): 62dB
Airborne acoustical noise (spinning): 76dB

Note:

The airborne acoustical noise emissions during washing/spinning for the standard 60°C cotton programme at full load.



The Creative Life

By service email:www.tcl.com

8C108-000xxx

A.1