

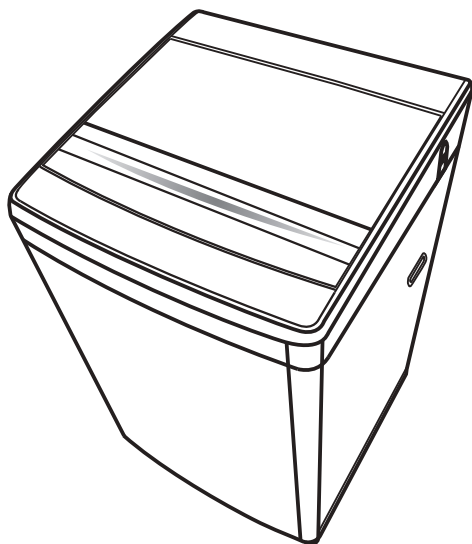

The Creative Life

- Before using your washing machine, please read this manual carefully and keep it for future reference.
- The drawings in this manual are for instruction only, it may vary from the model you buy

## ***Automatic Electric Washing Machine*** **OWNER'S MANUAL**



This manual is for  
TWA70-A101M

Inside you will find many helpful hints on how to use and maintain your washing machine properly. Just a little preventative care on your part can save you a great deal of time and money over the life of your washing machine. You'll find many answers to common problems in the chart of troubleshooting tips. If you review the chart of Troubleshooting Tips first, you may not need to call for service.

# Contents

Specifications and parameters .....	2
Safety precautions .....	3
Use precautions .....	5
Parts identification .....	6
Packing list .....	7
Remove the package .....	7
Install the bottom plate .....	7
Adjust the position .....	8
Install the drain hose .....	8
Install the inlet hose .....	9
The operation panel .....	10
Preparation before washing .....	12
The operation steps .....	13
Cleaning of The lint bag and filter .....	14
Cleaning the pump filter .....	14
Trouble shooting tips .....	14

# Specifications and parameters

Type/Mode	F107TLW
Rated power supply	220-230V~/50Hz
Application water pressure	(0.03~1.0)MPa
Rated washing capacity	7.0kg
Rated spinning capacity	7.0kg
Rated washing power	360W
Rated spinning power	300W
Net weight	23kg
Dimensions(mm)	515(W)X530(D)X870(H)

## Electronic controller

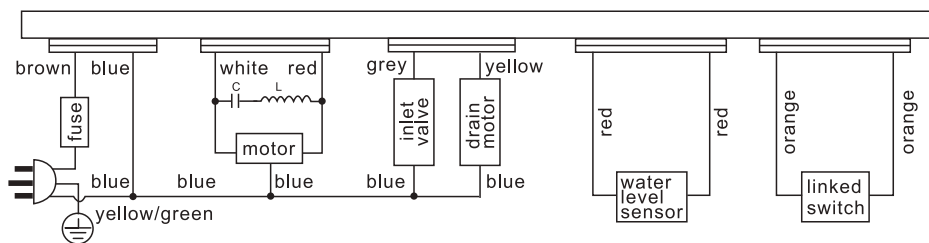

## Safety precautions

### WARNING

To reduce the risk of fire, electric shock, or injury to persons when using your appliance, follow basic precautions, including the following:

1. This appliance is not intended for use by persons (including children) with reduced physical, sensory or mental capabilities, or lack of experience and knowledge, unless they have been given supervision or instruction concerning use of the appliance by a person responsible for their safety. Children should be supervised to ensure that they do not play with the appliance.
2. If the supply cord is damaged, it must be replaced by the manufacturer, its service agent or similarly qualified persons in order to avoid a hazard.
3. The new hose-sets supplied with the appliance are to be used and that old hose-sets should not be reused.
4. Do not obstruct the opening in the base of the washing machine.
5. To ensure your personal safety and protect your property, please check the appliance grounded regularly.
6. For your safety, the information in this manual must be followed to minimize the risk of fire, explosion or electric shock, or to prevent property damage, injury to persons, or death. Your safety and the safety of others is very important. There are many important safety precautions in this manual and on your appliance. Always read and obey all safety messages.
7. This appliance is intended to be used in household and similar applications such as:
  - staff kitchen areas in shops, offices and other working environments;
  - farm houses
  - by clients in hotels, motels and other residential type environments;
  - bed and breakfast type environments;
  - areas for communal use in blocks of flats or launderettes.

# Safety precautions

## WARNING

To reduce the risk of fire, electric shock, or injury to persons when using your appliance, follow basic precautions, including the following:



### FORBIDDEN

Contents marked with this symbol are actions forbidden. Performing of those actions may result in damage of the machine or injure the personal safety of the user.

- ⊘ 1. Please do not damage power flexible cord and power plug to avoid electric shocking, short circuit and catching fire.
- ⊘ 2. Please do not pull out or insert the plug with wet hands to avoid electric shocking.
- ⊘ 3. Please do not disassembly and assembly the machine without authorization.
- ⊘ 4. Please do not wash down jacket, raincoat, fishing coat and similar clothes in the washer.
- ⊘ 5. Please do not let children climb the machine or peer into the rotating spin barrel to avoid accidents.
- ⊘ 6. Please do not install the machine in damp and raining environment to avoid electric shocking, catching fire, faults and distortion accidents.
- ⊘ 7. It is strictly prohibited to place and sit children or lay weights on the washer.
- ⊘ 8. Do not turn the appliance off by unplugging the power plug while the washer is in operation. Plugging the power plug into the wall socket again may cause a spark and result in electric shock or fire.



### NOTICE

Contents marked with this symbol are related to the safety of the product and the personal safety of the users. Please operate in strict conformity to the contents, otherwise it may cause damage of the machine or injure the personal safety of the user.

- ☺ 1. Please use correct power source . Turn off the water faucets and unplug the washer if the machine is to be left for an extended period of time, such as during vacations.
- ☺ 2. Please put the clothes evenly into the washing machine, clothes placing uneven will produce noise or vibration. Can not be hot, heavy objects (such as hot kettle, iron) is put in the washing machine.
- ☺ 3. It is prohibited to wash the clothes touching with kerosene, gasoline, alcohol and other flammable materials.
- ☺ 4. The water temperature shall not exceed 55°C when washing with warm water.
- ☺ 5. The machine must away from direct sunlight or heat source just like a heater.



### GROUNDED

This appliance must be grounded. In the event of malfunction or breakdown, grounding will reduce the risk of electric shock by providing a path of least resistance for electric current.

- 👉 1. This appliance is equipped with a cord having an equipment-grounding conductor and grounding plug.
- 👉 2. The plug must be plugged into an appropriate outlet that is properly installed and grounded in accordance with all local codes and ordinances.
- 👉 3. To ensure your personal safety and protect your property , please check the appliance grounded regularly.

## Use precautions

### ⚠ CAUTION

1. Your washing machine is for house use. Your washing machine can only wash for machine washable fabrics. Use the washer only for its intended purpose as described in this owner's Manual. Before use, the washer must be properly installed as described in this manual.
2. Regularly clean the power plug to remove dust and dirt to avoid connecting failure.
3. To prevent personal injury or strain, wear protective gloves whenever lifting or carrying the unit.
4. If a drain error occurs during an operation, check if there is a draining problem. If the washer is used when it is flooded because of a draining problem, it may result in electric shock or fire due to electric leakage.
5. To minimize the possibility of electric shock, unplug this appliance from the power supply or disconnect the washer at the household distribution panel by removing the fuse or switching off the circuit breaker before attempting any maintenance or cleaning.
6. If the water supply hose comes loose from the faucet and floods the appliance, unplug the power plug. Failing to do so may result in electric shock or fire.
7. Store and install the washer where it will not be exposed to temperatures below freezing or exposed to outdoor weather conditions. Failure to follow this warning can cause serious leak damage.

### ⚠ WARNING

1. Customers are not allowed to change the power line without professional skills.
2. Do not leave metal objects (safety pins, hair pins, etc.) or bleach in the tub for long periods of time. This may cause the tub to rust. If rust appears on the surface of the tub, apply a neutral cleansing agent to the surface and use a sponge to clean it. Never use a metal brush.
3. Do not wash articles that have been previously cleaned in, washed in, soaked in, or spotted with gasoline, dry cleaning solvents, or other flammable or explosive substances, as they give off vapors that could ignite or explode.
4. Do not place items exposed to cooking oil in your washer. Items contaminated with cooking oils may contribute to a chemical reaction that could cause a load to catch fire.
5. Please do not place on the washer burning candle, mosquito-repellent incense, cigarette and other flammable things, as well as electric stove, air heating fan and other heating sources.
6. Please do not insert your hand and take out clothes inside the spin barrel before it is fully stopped.
7. Do not use natural hand-washing soap in the washer. If it hardens and accumulates inside the washer, it may cause problems with the product, discoloration, rust, or bad odors.
8. Do not wash large laundry items such as bedding in the washing net. Failing to do so may result in injury due to abnormal vibrations. Place smaller items, such as lace socks and lingerie in the washing net.
9. Do not place any non-laundry objects, such as shoes, food waste, or animals into the washer. This can cause abnormal vibrations that can damage the washer, and, in the case of pets, cause severe injury or death.

## ▲ DANGER

1. Keep laundry products out of children's reach. To prevent injury to persons, observe all warnings on product labels. Failure to comply with these warnings could result in serious injury to persons or death. If a child places a bag over their head, the child may suffocate. Do not let children or infirm persons use this washer unsupervised. Failing to do so may result in electric shock, burns or injury. Destroy the carton, plastic bag, and other packing materials after the washer is unpacked. Children might use them for play. Cartons covered with rugs, bedspreads, or plastic sheets can become airtight chambers. Failure to comply with these warnings could result in serious injury to persons or death.
2. If the appliance is flooded, cut the power immediately and contact your nearest service center. If the appliance emits a strange noise, a burning smell, or smoke, unplug the power plug immediately and contact your nearest service center. Failing to do so may result in electric shock or fire.
3. Do not attempt to repair, disassemble, or modify the appliance yourself. Do not use any fuse (such as copper, steel wire, etc.) other than the standard fuse. If you need to repair or reinstall the appliance, contact your nearest service center. Failing to do so may result in electric shock, fire, problems with the product, or injury.

## Parts identification



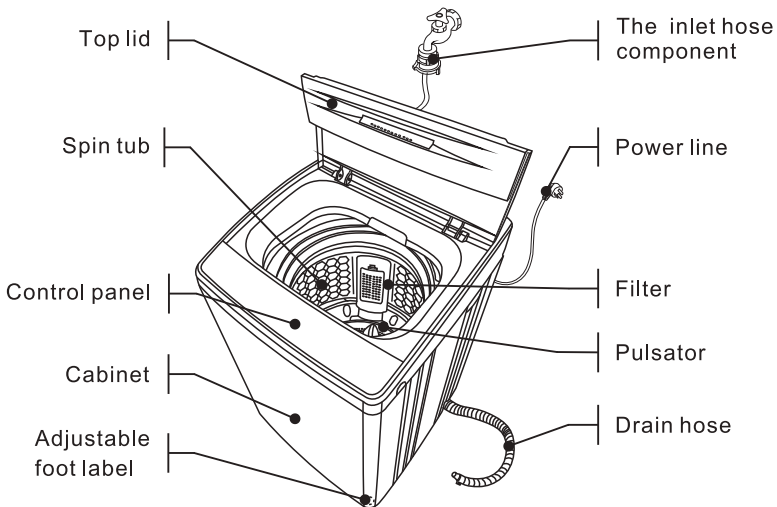

### Parts



## ▲ CAUTION

Please put washing powder into the dispenser drawer directly. Be sure to use the new water pipes in the packing, the old water inlet pipe which house's kept can not be used repeated.

# Packing list

Name	Owner's Manual	Tapping screw	Water inlet hose	Bottom cover	Drain hose component
Diagram					
Quantity	1	1	1	1	1

## Remove the package

- Remove the package straightly from the top of the washing machine.
- Take out the machine from the foam cushion.

### ⚠ WARNING

- Operation or washing on the foamed cushion is strictly forbidden.
- Do not open the package from the top. It is very easy to damage the package, and makes it difficult to remove the package.
- Do not put the package on fire place, so as to avoid injury to people and damage to property.
- Packaging material can be dangerous for children. There is a risk of suffocation! Keep all packaging from children.

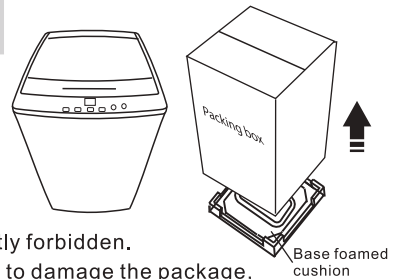

## Install the bottom plate

- The one purpose of the bottom plate is to protect the personal safety of the user or the safety of the machine .
- The other purpose of the bottom plate is to block noise and give a quiet performance from the washing machine during operation.

Steps:

- 1.Lay the washer on its back.
- 2.Insert the plate in the bottom of the machine as shown in the figure.
- 3.Use a screwdriver to tighten the screw securing the panel to bottom of the washer.
- 4.Once the screw is tight, and the panel is secure return the washer to the its standing position.

### ⚠ CAUTION

- Using the washing machine without leveling it may result in malfunction caused by the production of excess vibration and noise.
- Use the leveling feet only for leveling the washing machine. If you raise the leveling feet unnecessarily, it may cause abnormal vibration of the washing machine.

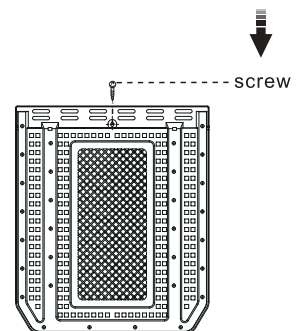



## Adjust the position

The largest allowable slope of the base of the machine is  $2^{\circ}$ .

Slanting or rough ground will result in unstable running or stoppage of the machine. Please adjust it by the following method:

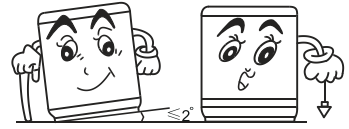

The right foot in front of the washing machine is an adjustable foot. When the washing machine is placed unevenly, the foot can be adjusted to be stable by left or right rotation. For models with adjustable foot lock fasteners, the adjustable foot lock fasteners can be screwed to the top to lock the adjustable foot.

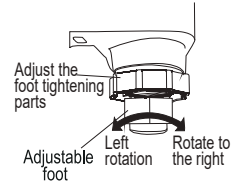

## Install the drain hose

- First install the drain hose hook on the part of outer drain hose component.
- Put the drain hose clamp on the outer drain hose, Insert the outer drain hose into the joint for it, and then clutch tightly with drain hose hoop.
- Completely slide the drain hose over the sewer.
- Fix it with the hoop. ( As shown in the figure )

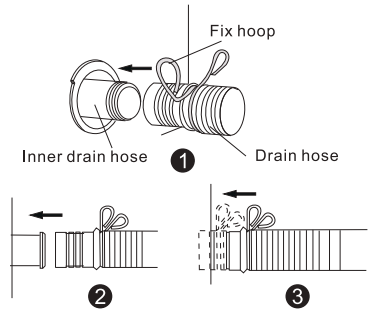

### ⚠ CAUTION

Your washing machine using the common drain system, please place the drain hose as the Figure 1.

- Drain height should be less than 10cm, otherwise it will cause poor drainage. Meanwhile prohibited stampede or squeeze drain hose.
- If the drain hose need to be lengthen , please purchase another drain hose, and it shall not be less than the inner diameter of 30mm, the length should not less than 1.5m.

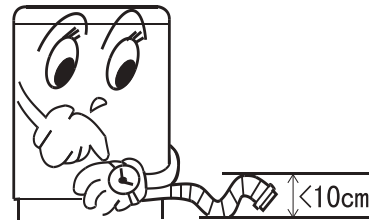

Figure 1

If you use the Upper drain system, please place the drain hose as the Figure 2. (For option)

- Ensure the drain hose is mounted at a suitable height. (Between 800~1200mm above the floor)
- Do not push it too far down the drain pipe or siphoning will occur.

For appliances intended for use at altitudes exceeding 2000m, the maximum altitude of use shall be stated.

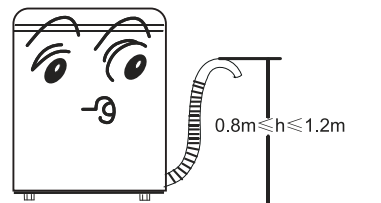

Figure 2

# Install the inlet hose

Washing machine has two different kinds of the water inlet style, one is the cold water inlet valve and the other is the cold and hot water inlet valves. For your appliance, you can only use the cold water inlet valve.

## The cold water inlet valve

1、 If you choose the hose of one touch type, you can install it as the following steps.

- 1** untighten the upper connector screw.

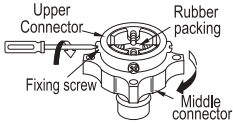

In case the diameter of the faucet is large remove the guide plate.

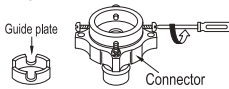

- 2** Push the upper connector up till the rubber packing is in tight contact with the faucet. Then tighten the 4 screws.

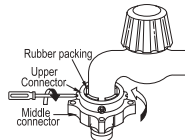

Turn the middle connector not to have water leaked.

- 3** Connect the water supply hose to the middle connector, pushing the plate down.

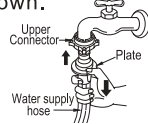

To separate the water supply hose from the middle connector shut off the faucet. Then pull the inlet hose down, pushing the plate down.

- 4** Make sure that the rubber seal is inside the hose connector.

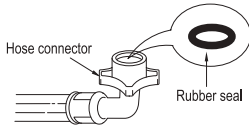

Your machine comes with only cold water connection. Make sure that there are no kinks in the hose and that it is not crushed.

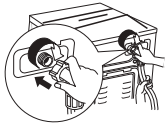

1. Connect the water inlet hose.
2. Insert the power plug into the electrical socket.
3. Ensure the drain hose is mounted at the correct height.
4. Select a suitable location for the washer on a hard, even surface away from direct sunlight or heat sources, e.g. radiators, cooking appliances, etc.

**Notice**

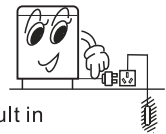

5. Any floor unevenness may result in unstable working or abnormal noise. Please ensure the machine is level.

2、 If you choose the hose of screw type, you can install it as the following steps.

- 1** Check the tap mouth. Let the taps to mate with the skirtlike nut of water inlet hose.



- 2** Pull the skirtlike nut of one end of the water inlet hose upwards, and then screw into the tap tightly.



- 3** Grasp the water inlet hose by hand and pull it downwards to see whether it is secured.



- 4** Screw the nut on the other end of the water inlet hose into the water inlet of the washing machine to the most.

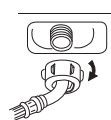

## ⚠ CAUTION

After installation water inlet hose, do not start the washing machine in haste. Open the tap to create certain water pressure in the hose to check whether there is any leakage in the connector on both ends. If the pressure is too high, please shut the tap a little to avoid water leakage.

### The cold and hot water inlet valves.(For option)

If you choose the washing machine which have cold and hot water inlet valves, you can install it as the following steps.

1

Inspect the threaded fitting on each hose and make sure there is a rubber seal in place in both end.

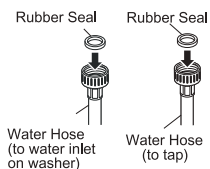

2

Connect the water supply hoses to the hot and cold water faucets tightly by hand and then tighten another 2/3 turn with pliers.

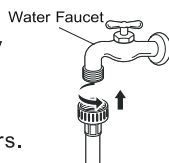

3

Always run a gallon or two of water through each inlet hose to flush dirt, scale and other debris out of the water lines. Doing so will help prevent future problems with clogged filter screens, and will also allow you to verify which hose is hot and which is cold.

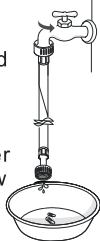

4

Attach the hot water line to the hot water inlet on the back of the washer. Attach the cold water line to the cold water inlet on the back of the washer. Tighten the fittings securely. Turn on both faucets all the way and check for leaks at both ends of the hoses.

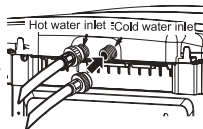

## ⚠ WARNING

- Do not overtighten. Damage to the coupling can result.
- Do not overtighten the hoses. Overtightening can damage the valves resulting in leaking and property damage.

## The operation panel

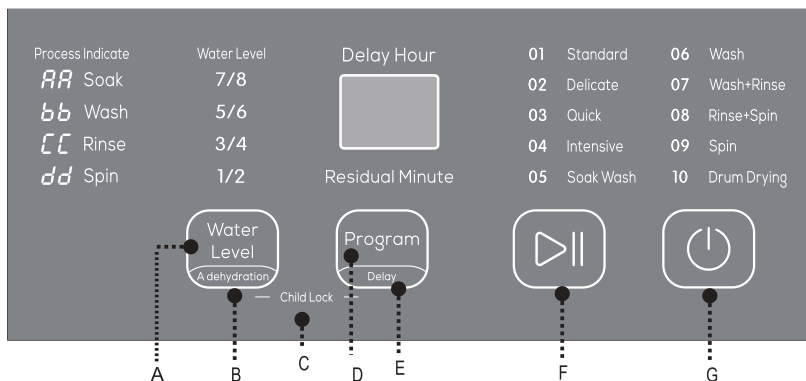

#### **A、 The "water level"button**

- When turn on the power, the default setting is standard procedure. Press the "Start / Pause" button, will perform fuzzy function, the machine will automatically detect the amount of laundry, the water level is set automatically because of as the different degree of wet and dry cloth to determine the actual water level. When the choice is not the standard procedure, there is no fuzzy function, washing machine will display the default level.
- When the machine is on power , press the [water level] key to select the water level, indicator shows from "1" to "8", then the fuzzy function is canceled, you can select the appropriate level based on the amount of laundry.
- In the process of washing(including rinsing),if you want to add water, you can push the"Star/Pause" button,then push the " Water level" button to select higher level of water, the push the" Star/Pause" button again, it will add water to given water level automatically. If you choose a lower water level, it will be reflected in next wash.
- Automatic feed water control: In the process of soaking, washing and rinsing, the washing machine will add water to given water level if it detect the water level reduce.

#### **B、 The "A dehydration" button**

- After pressing the"ON/OFF" button, it can directly enter into the singer-spin program by pressing the "A dehydration" button for 3 seconds. The spin-time last 8 minutes in total.

#### **C、 The"Child Lock"button**

- After washing machine start up, the machine is running, and if necessary, you can simultaneously press the [Water level] + [Program] key three seconds or more to start the "child lock" function, beep issue "Didi, Didi" twice, under the child lock, any key is invalid, when any button is touched at this time ,the machine will issue an invalid beep.
- Lift: Press the [Water level] + [Program] key about three seconds to cancel child lock, beep issue "Didi, Didi" twice, lifting the child lock, key functional recovery. When the program ends, or failure alarm error child lock is automatically released.
- Note: Under the "child lock" function, opening the top lid will start the "pause" program, there will be beep alarm with "Didi, Didi", the indicator shows "CL" and water will be drained automatically until water is emptied after 15 seconds. Once closed the top lid, only if unlock the "child lock" function, the program will be proceeded. Otherwise the washing machine will automatically switch off the power after 10 minutes.

#### **D、 The"Program"button**

- The default setting is standard procedure.
- According clothing material, quantity and dirty laundry degree, you can choose the right program. For details, see the special features.

#### **E、 The"Delay"button**

- Push the "Delay" button to set delay time option (2-24hr) and then push the "Start/Pause" button to start the delay function.

#### **F、 The"Start/ Pause"button**

- After the power is switched on ,press the "start/pause" button to start the machine.
- During operation, press the "start/pause" button to pause the machine.
- Press the "start/pause" button again to restart the machine.

#### **G、 The"ON/OFF"button**

- Push the "ON/OFF" button to switch on the power.
- To turn off the power, press the "ON/OFF" button.
- If the "start /pause" button is not pushed within 10 minutes, the washing machine will automatically switch off the power.



**Energy efficiency testing procedures**

- Plug in the power plug again, and press the **【Power】** + **【Start/Pause】** for more than 3 seconds within 10 seconds after the whole machine is powered on, select the 8th water level, and enter the BEE energy efficiency test program.

**Special features**

Program	Properties and Uses	Program	Properties and Uses
<b>Standard</b>	● Washing the Mixed fabrics laundry.	<b>Wash</b>	● Independent single-washing procedure, suitable for cotton type fabric.
<b>Quick</b>	● Small load of lightly soiled laundry .	<b>Intensive</b>	● Independent strong washing procedure, suitable for jeans, overalls stains such as serious, large weight of the fabric.
<b>Delicate</b>	● Delicate items that are machine washable.	<b>Spin</b>	● Independent spinning procedure, suitable for cotton type fabric.
<b>Drum Drying</b>	● Drying the inner and outer tub to avoid the growth of mildew.	<b>Wash+ Rinse</b>	● Independent washing and rinsing procedures, suitable for cotton type fabric.
<b>Soak Wash</b>	● Increasing washing effects, suitable for washing cotton type fabric.	<b>Rinse+ Spin</b>	● Independent rinsing and spinning procedures, suitable for cotton type fabric.

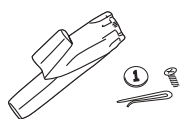
**Preparation before washing**

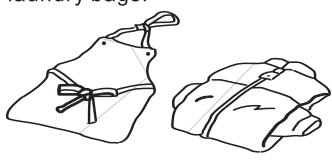
<p>Check if the laundry has any special washing instructions.</p>  <p style="text-align: center;">Dry-cleaning</p>	<p>Clear the pockets. Take out loose items such as coins, sand, hairpins etc.</p> 
<p>Tie any long strips, fasten buttons and close zippers.</p> 	<p>The weight of the laundry shall not exceed the rated capacity. Loosen the laundry before placing it evenly in the tub.</p> 
<p>When the machine is running buttons may cause noise. To reduce the noise turn clothes inside out or place them in a laundry bags.</p> 	<p style="text-align: center;"><b>NOTICE</b></p> <ol style="list-style-type: none"> <li>Check if the laundry is suitable for machine washing.</li> <li>Divide the laundry into color fast and non-colour fast items.</li> <li>Place items that do not absorb water easily into the water by hand.</li> <li>For heavily soiled items, please first remove loose dirt, then apply detergent directly to the stain before washing.</li> <li>For those items that may get lint or are furry or fluffy, please turn them inside out before washing.</li> <li>Do not put laundry polluted by chemicals into the washing machine.</li> </ol>

# The operation steps

**1** Connect the water resource and open the faucet.

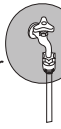

**2** Connect the power.

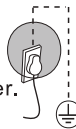

**3** Place the upper drain hose as the figure.

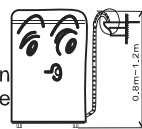

or: Place the drain hose as the figure.



Process Indicate	Water Level	Delay Hour	01 Standard	06 Wash
RR Soak	7/8		02 Delicate	07 Wash+Rinse
bb Wash	5/6		03 Quick	08 Rinse+Spin
cc Rinse	3/4	Residual Minute	04 Intensive	09 Spin
dd Spin	1/2		05 Soak Wash	10 Drum Drying



----- Child Lock -----

**4** Open the lid, put in clothes and suitable amount of washing power. Close the lid.

**5** Press the "ON/OFF" button.

**6** Depending on your needs, select necessary procedures personalize.

**7** Press the "start/pause" button.

## When the programme has finished.

- When the machine stops, the buzzer will buzz continuously for 6 times and the power will be automatically cut off.
- Turn off the water tap.
- Pull out the power plug for safety.

## ⚠ WARNING

- Please check if power point has been earthed condition before using to guarantee your safety.
- Close the lid of the door when machine is running, otherwise, it will automatically stop working during spin process and send out abnormal warning.
- The washer will not work when the filled water does not reach the set water level.
- The selection of rinse water level: the level is equal to wash water level. When the rinse program start, the indicator light which stand for rinse level flickered. User can select the rinse water level according to needs. Rinse level exceed that wash level all the time. It shows the wash level if not press this button. And only show rinse level when rinse.
- After pressing down [ ON/OFF ], if the [ Start / Pause ] button is not pressed, the power will be automatically cut off after 10 minutes.
- The thickness, size and type of clothes will influence the actual capacity. Be careful to only load a reasonable amount of laundry.
- It is suggested not to use high sudsing detergent. Choose a low suds or high efficiency detergent.
- To reduce the risk of fire, electric shock, or injury to persons, read and follow this entire Owner's Manual, including the Important Safety Instructions, before operating this washer.
- Unplug the washer before cleaning to avoid the risk of electric shock. Failure to follow this warning can cause serious injury, fire, electric shock, or death.
- Never use harsh chemicals, abrasive cleaners, or solvents to clean the washer. They will damage the finish.

## Cleaning of The lint bag and filter

The special circulation water flow is designed for this washer, thus the flock powder and flock residues will be automatically collected into the filtering bag. After application, the user shall regularly clean the filtering bag to remove the flock powder and flock residues. Detail operation methods are following.

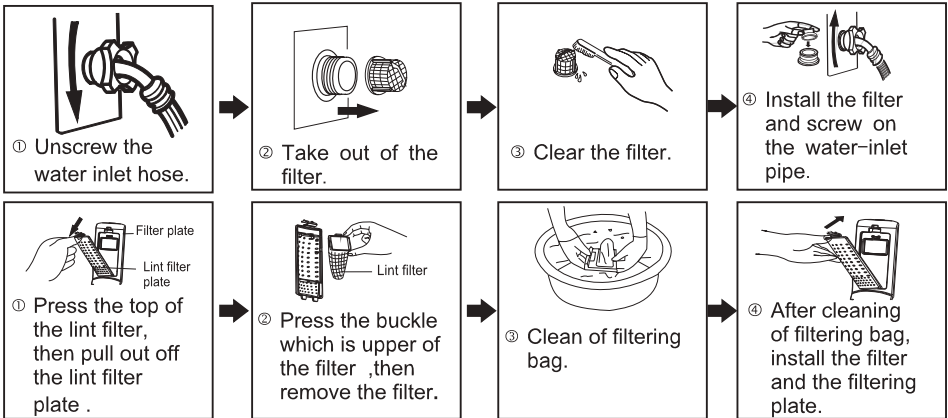

## Cleaning the pump filter

Only for the upper drain system,detail operation methods are following.Clean up every two months.



## Trouble shooting tips

### Common occurrences

Situation	Cause
• The spinning is intermittent when it starts.	• Redistribute the load evenly. Close the top lid.
• The wash procedure pauses.	• The cloth sensor is detecting, it will add water after about 55 seconds.
• Select spin program, but it does not work.	• The program is setting the drain time ,a period of time is needed before the spin program starts.
• There maybe have some water in the drain hose when the first use.	• It is the water remaining after the performance inspection by the factory.

















※ If the machine does not work normally, or alarms, please check as the following list.If the problem persists, please contact local service office or the sales service department of our company. The customer should not dismantle the machine without professional skills.

Phenomenon	Inspection Items	Phenomenon	Inspection Items
Washer will not turn on.	Reset circuit breaker or replace fuse. Do not increase fuse capacity. If the problem is a circuit overload, have it corrected by a qualified electrician.	Suddenly stop working.	Is the power or water supply cut off suddenly? If you press the "start/pause" button?
At the first time you use, the machine may have a small amount of water.	Normally, the water was the factory inspection remained.	No spin	When washing machine settings drainage time, it is starting spin after go through a period of time .
No washing	If the power is off or the fuse is burned out. If the power supply voltage is too low. If the water reaches to the required water level.(The machine will not work before reaching the required water level)	Noise	The machine is tilted or shaking? If the coins, zippers and other objects dropped in? Is the noise normal when the motor working ?
Can not operate the buttons.	Did you use the "Child Lock" function ? If you want to choose other function after power on, please press "start/pause" button firstly.	No drain or drain too slowly	Whether the drain is bent, blocking, freezing? Is the highest point of drain above ground 10cm?
No water flows in, or flows slowly.	If the tap turn on, or the water supply cut off? If the screen of the inlet valve is blocked by dirt. whether the tap or the Water-filling pipe has been frozen . If you have choose the "Delay" function? If the "start/pause" button has not pressed?	Control pane become hot.	Electronic Components thermal effect is a normal phenomenon.
Load is too wet at the end of the cycle.	The spin effect will change due to different types of clothing .	Washing effects are not good.	Select a proper procedure . Add the proper detergent quantity according to the instructions in detergent package.
		Wash cycle time is longer than usual.	This is normal. The washer adjusts cycle time automatically to provide optimal results for the selected cycle. The time remaining shown in the display is only an estimate. Actual time may vary.

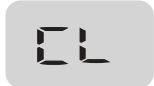

## Trouble Phenomenon

## Solutions

		No water flows in.		If the tap turn on, or the water supply cut off ? If it still has such problem , please contact local service office.
		The machine does not drain.		Is the water drain hose placed too high? Is the end of water drain hose blocked?
		The lid is not closed.		Close the lid.
		The water level sensor has failed.		please contact local service office.
		The machine is not balance.		If clothing piled up at one side of the barrel or If the machine is placed unsteadily.
		The child-lock alarm.		Remove the child-lock function.



The Creative Life

8C104-000XXX  
A.1

