



**ROBOT Vacuum
Cleaner
MVC-15C**

**PLEASE READ THE
MANUAL CAREFULLY
BEFORE USING AND
KEEP IT PROPERLY FOR
FUTURE USE**

Warning notices: Before using this product, please read this manual carefully and keep it for future reference.

The design and specifications are subject to change without prior notice for product improvement. Consult with your dealer or manufacturer for details.

INSTRUCTION MANUAL

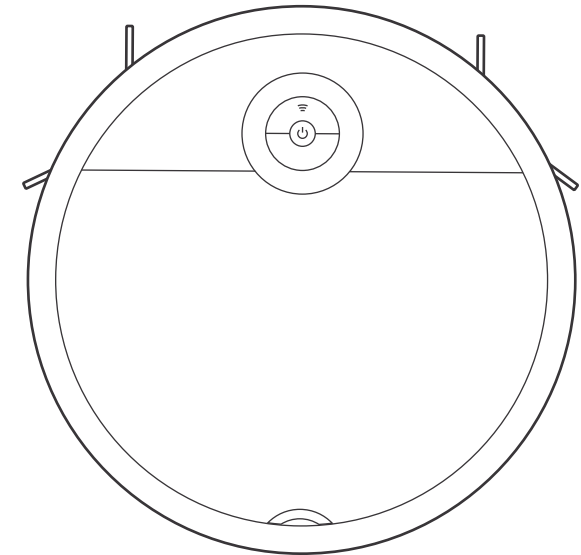

make yourself at home

CONTENTS

Safety Instructions 01

Technical data 09

Product Introduction 11

Illustration of Appliance 13

Product Operation 15

Installing the Side Brushes 15

Charging your Robot Vacuum 16

Introduction of Remote Control 17

Power ON/OFF 19

Clean/Pause 19

Using APP 20

Mopping 21

Product Maintenance 22

Cleaning the Side Brush 22

Cleaning the Dust Bin, Sponge and Filter 22

Cleaning the Water Tank 23

Cleaning the Sensor and Wheel 24

Cleaning the Charge Terminal 24

Cleaning the Brushroll 25

Trouble Shooting 26

SAFETY INSTRUCTIONS

Warning for the machine

1. This appliance can be used by children aged from 8 years and above and persons with reduced physical, sensory or mental capabilities or lack of experience and knowledge if they have been given supervision or instruction concerning use of the appliance in a safe way and understand the hazards involved.
Children shall not play with the appliance.
Cleaning and user maintenance shall not be made by children without supervision.
2. Plug must be removed from the socket-outlet before cleaning or maintaining the appliance.
Switch off before cleaning or maintaining the appliance.
3. If the supply cord is damaged, it must be replaced by a special cord or assembly available from the manufacturer or its service agent.
4. WARNING: For the purposes of recharging the battery,
only use the detachable docking station provided with this appliance.
Use only with i5-DS docking station.
5. This appliance contains batteries that are only replaceable by skilled persons.

6. Do not bring the smart robot close to heat source, radiation or burning cigarette butts. It is strictly forbidden to vacuum the following objects:
 - 1) All liquids such as water and solvents;
 - 2) Lime, cement dust and other construction dust and garbage;
 - 3) Heat generating objects, such as unextinguished carbon butts, cigarette butts;
 - 4) Sharp fragments, such as glass, etc.;
 - 5) Flammable and explosive items, such as gasoline and alcohol products.
7. Before using, please remove all fragile items from the ground (such as glasses, lamps, etc.), and items that may be tangled with the side brush, Roller brush and drive wheels (such as wires, curtains and other easily-entangled materials).
8. Please pay attention to your hair and avoid entanglement on wheels or roller brushes when using, cleaning and maintaining the robot.
9. Do not use this product at an altitude of more than 2000m.



10. Correct Disposal of this product.

This marking indicates that this product should not be disposed with other household wastes throughout the EU. To prevent possible harm to the environment or human health from uncontrolled waste disposal, recycle it responsibly to promote the sustainable reuse of material resources. To return your used device, please use the return and collection systems or contact the retailer where the product was purchased. They can take this product for environmental safe recycling.

11. Warranty Information

The manufacturer provides warranty in accordance with the legislation of the customer's own country of residence, with a minimum of 1 year (Germany: 2 years), starting from the date on which the appliance is sold to the end user.

The warranty only covers defects in material or workmanship.

The repairs under warranty may only be carried out by an authorized service centre. When making a claim under the warranty, the original bill of purchase (with purchase date) must be submitted.

The warranty will not apply in cases of:

- Normal wear and tear

- Incorrect use, e.g. overloading of the appliance, use of non-approved accessories
- Use of force, damage caused by external influences
- Damage caused by non-observance of the user manual, e.g. connection to an unsuitable mains supply or non-compliance with the installation instructions
- Partially or completely dismantled appliances

12. Wireless network:2400-2483.5MHz, MAX POWRE:20dBm.

To satisfy RF exposure requirements, a separation distance of 20 cm or more should be maintained between the antenna of this device and persons during device operation.To ensure compliance, operations at closer than this distance is not recommended.

Warning for docking station







1. "IMPORTANT SAFETY INSTRUCTIONS – SAVE THESE INSTRUCTIONS" and "DANGER – TO REDUCE THE RISK OF FIRE OR ELECTRIC SHOCK, CAREFULLY FOLLOW THESE INSTRUCTIONS".
2. This appliance can be used by children aged from 8 years and above and persons with reduced physical, sensory or mental capabilities or lack of experience and knowledge if they have been given supervision or instruction concerning use of the appliance in a safe way and understand the hazards involved.
Children shall not play with the appliance.
Cleaning and user maintenance shall not be made by children without supervision.
3. Plug must be removed from the socket-outlet before cleaning or maintaining the appliance.
Switch off before cleaning or maintaining the appliance.
4. If the supply cord is damaged, it must be replaced by a special cord or assembly available from the manufacturer or its service agent.
5. Docking base is only applicable to the product MVC-I5C. (Battery pack type: Li-ion, DC 14.4 V, 2600 mAh)
The Docking base will automatically start charging after Robot Vacuum Cleaner returned to the base.

6. Warning: The battery charger(Docking station) is not intended to charge non-rechargeable batteries.

Warning for battery

1. The product must be powered off before removing the battery.
2. Please note that do not disassemble the battery by yourself.
3. If you need to replace it, please contact the after-sales service center.
4. Please dispose of used battery according to local laws and regulations.
5. Do not dismantle, open or shred the battery.
6. Do not expose batteries to heat or fire. Avoid storage in direct sunlight.
7. Do not short-circuit a battery.
8. Do not store batteries haphazardly in a box or drawer where they may short-circuit each other or be short-circuited by other metal objects.
9. Do not subject batteries to mechanical shock.
10. In the event of a leaking, do not allow the liquid to come in contact with the skin or eyes. If contact has been made, wash the affected area with copious amounts of water and seek medical advice.
11. Do not use any charger other than that specifically provided for use with the equipment.

12. Do not use any battery which is not designed for use with the equipment.
13. Do not mix different manufacture, capacity, size or type within a device.
14. Keep batteries out of the reach of children.
15. Seek medical advice immediately if the battery has been swallowed.

	[symbol IEC 60417-5957 (2004-12)]	for indoor use only
	[symbol ISO 7000-0790 (2004-01)]	read operator's manual
	[symbol IEC 60417-5031 (2002-10)]	direct current
	time-lag miniature fuse-link where X is the symbol for the time/current characteristic as given in IEC 60127	
	[symbol IEC 60417-5032 (2002-10)]	alternating current
	[symbol IEC 60417-5172 (2003-02)]	class II equipment

16. Keep batteries clean and dry.
17. Do not leave a battery on prolonged charge when not in use.
18. After extended periods of storage, it may be necessary to charge and discharge the batteries several times to obtain maximum performance.
19. The batteries give their best performance when they are operated at normal room temperature ($20\text{ }^{\circ}\text{C} \pm 5\text{ }^{\circ}\text{C}$).
20. Retain the original product literature for future reference.
21. The battery may be irreversibly damaged if the battery is in low power for a long time. It is recommended that the battery retain sufficient power before storage.

TECHNICAL DATA

1. Product Model: MVC-I5C
2. Host Charging Voltage: 17.2V $\overline{=}$
3. Host Rated Voltage:14.4V $\overline{=}$
4. Host Rated Power:55W
5. Docking Station Model:i5-DS
6. Docking Station Input:100-240V \sim ,50/60Hz,24W
7. Docking Station Output:17.2V $\overline{=}$,1A
8. Battery Model:BP14426E
9. Battery Rated Voltage:14.4V $\overline{=}$
10. Battery Capacity:2600mAh 37.44Wh
11. Charging Limit Voltage:16.8V $\overline{=}$

Note: you can also view the instructions on the app.

PRODUCT INTRODUCTION

Robot Vacuum

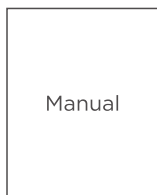
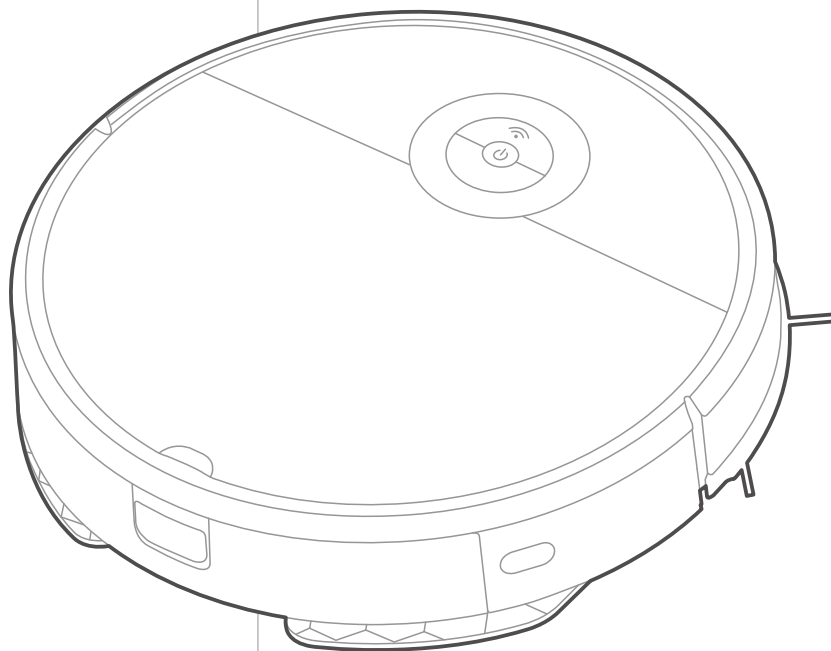

Instruction manual x1

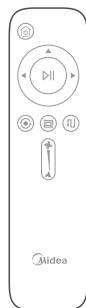

Remote control x1

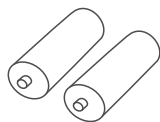

Battery x2

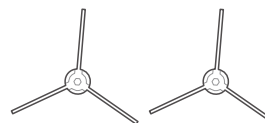

Side brush x2 Pairs

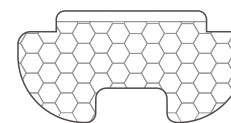

Mop holder x1

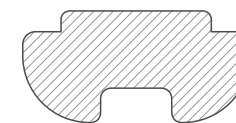

Mopping pad x2

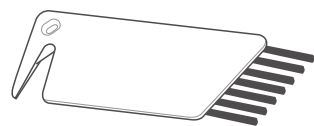

Cleaning brush x1

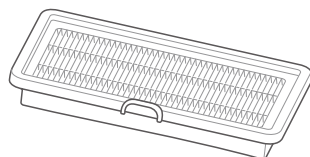

Filter x1

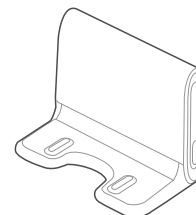

Docking station x1



Power cord x1

Illustration of Appliance

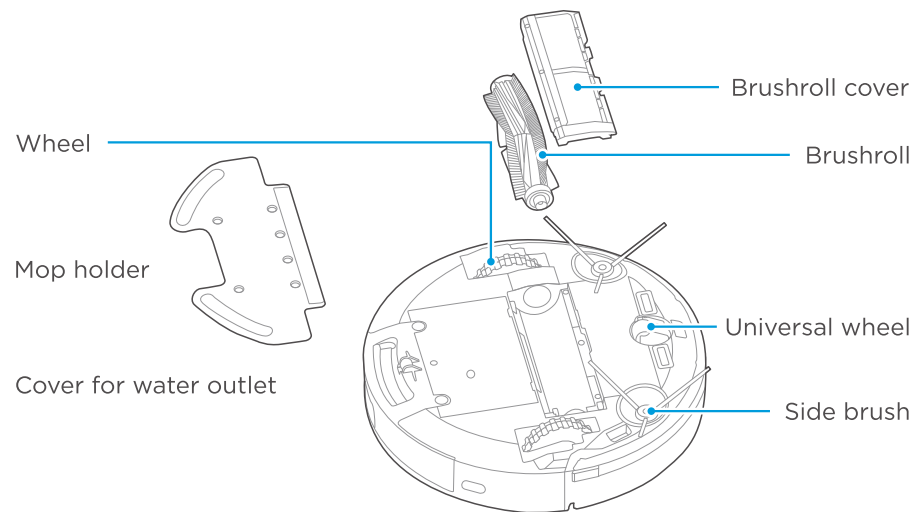
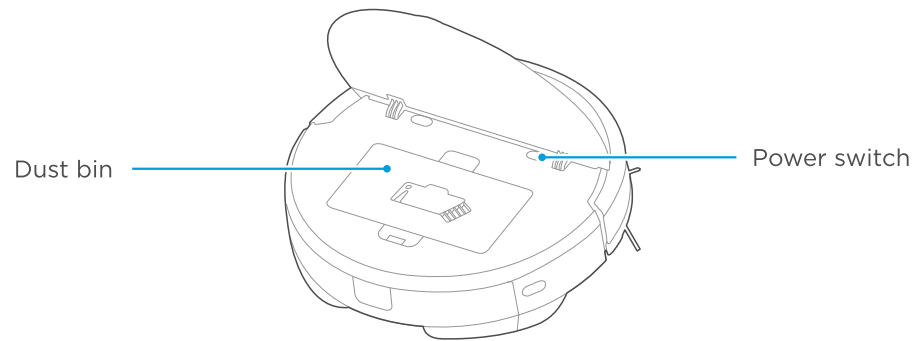
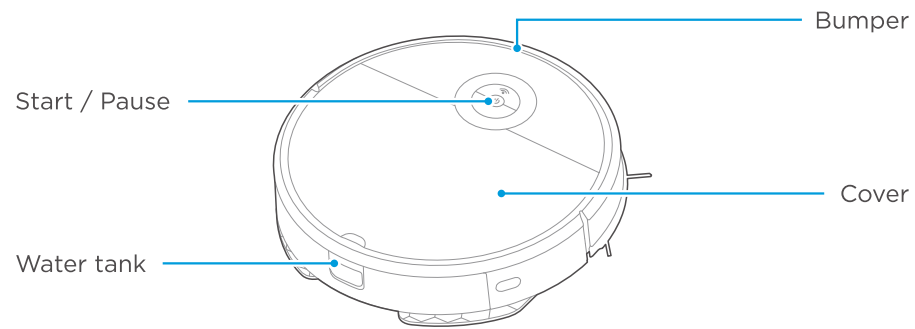
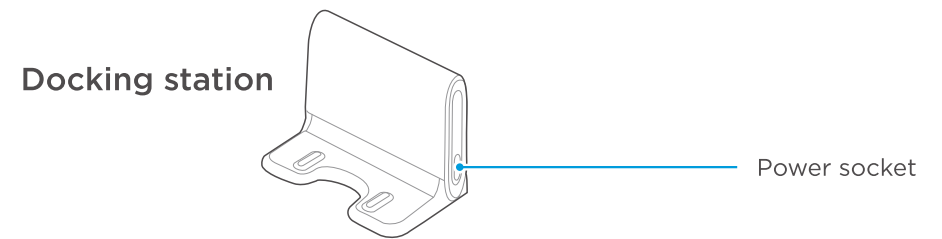
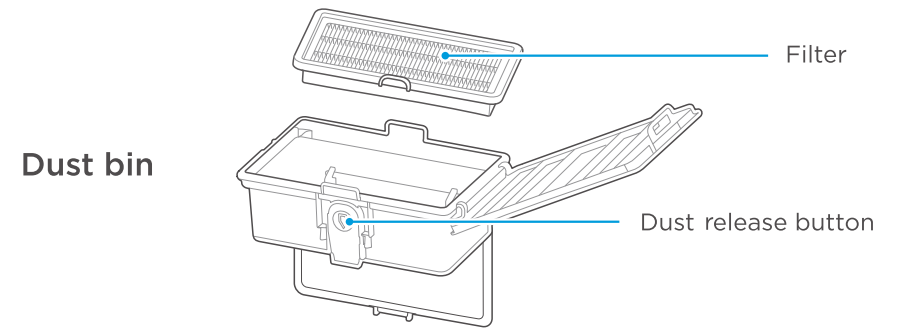
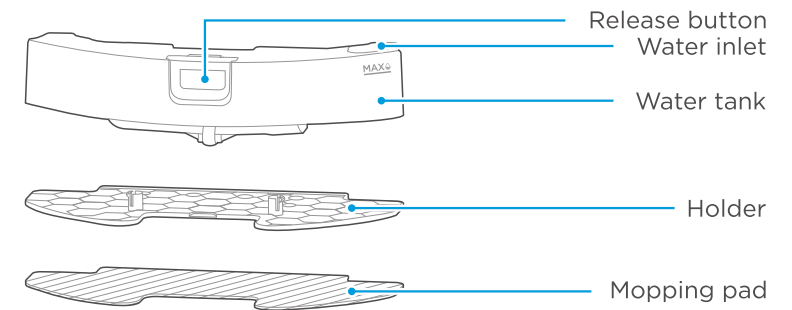

Illustration of Appliance



Water tank assembly



PRODUCT OPERATION

NOTE

- 1 Do not use your robot on wet surfaces or surfaces with standing water. Before using the product on a rug with tasseled edges, please fold the rug edges under.

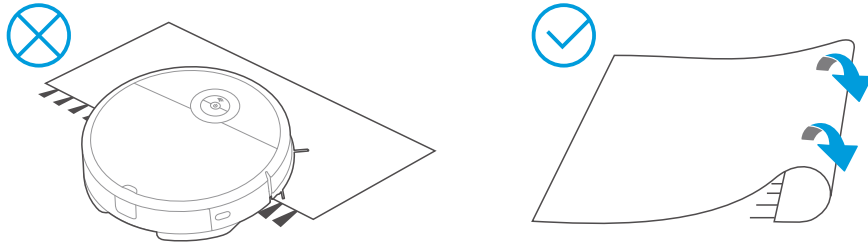

- 2 Prepare room for cleaning, it is suggested to tidy up the room such as picking up small objects from the floor and clearing away loose cords.

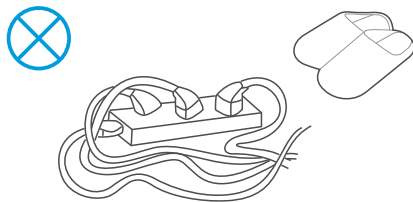

- 3 When vacuum is charging, a white light will flash on the top of the vacuum;
- 4 When charging is complete, the white light will remain constant;
- 5 When the battery is low, a red flashing light will show;
- 6 If the robot is cleaning when low battery is identified, the robot will automatically find the docking station to charge.
- 7 The robot can also be manually sent back to the docking station to charge by using the remote, or app.
- 8 Before charging, it is suggested to empty the water tank and remove the mopping pad and holder.

Installing the Side Brushes

- 1 Turn the unit over.
- 2 With unit upside down, align side brush over brush post.
- 3 Press down side brush until it snaps in place.
- 4 Ensure side brushes can rotate freely.

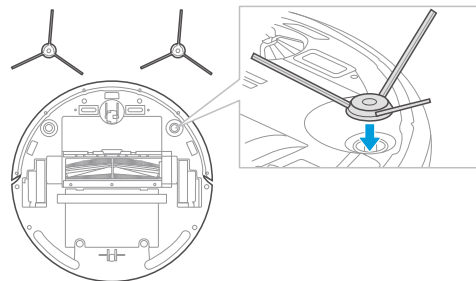

Charging your Robot Vacuum

- 1 Put the docking station well: Place the docking station against a wall and remove all of obstructions around the docking stand, as shown in the figure below.

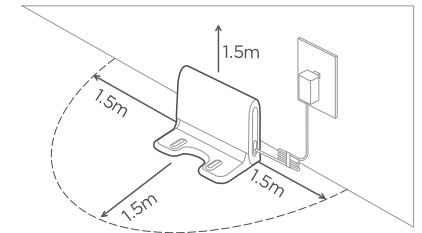

- 2 Open the cover and slide power switch to on.

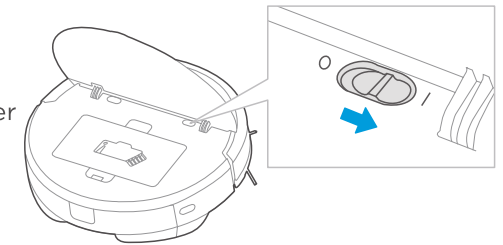

- 3 Place vacuum on the docking station, ensuring the charging contacts are touching. A white light will start flashing, indicating the robot is charging.

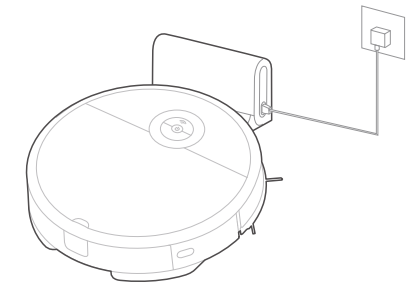

Charge for 12 hours before first use.

NOTE

To effectively extend battery life, you should:

- 1 For the first use, please charge for 12 hours;
- 2 When the battery is low power, please charge it as soon as possible;
- 3 If you do not use the appliance for an extended period of time, fully charge the battery and put it in a ventilated and dry place;
- 4 If the appliance is not used for more than 3 months, charge the appliance for 12 hours.

Introduction of Remote Control



Remote control will work when within 16 feet of the robot.

Docking

Vacuum will return to docking station to charge.

Start/Pause

Start or pause cleaning. The robot will automatically begin Smart Path cleaning.

Spot cleaning

The robot will clean a specific area in a spiral pattern.

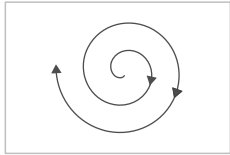

Suction decrease

Decreases the suction power.

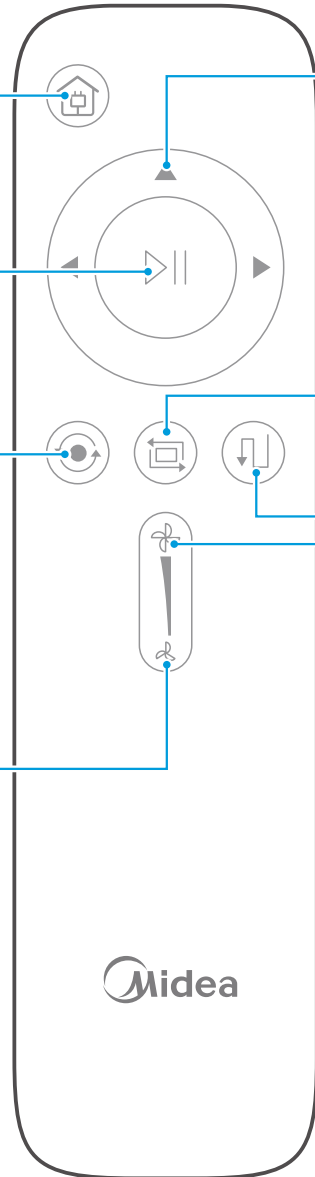

Direction

Manually control the direction of the robot (forward, left, and right). Note that the robot does not vacuum when in manual mode.

Edge cleaning

The robot will clean edges of the room and furniture.

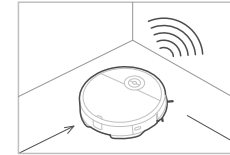

Zig-zag cleaning

The robot will clean in a zig-zag route.

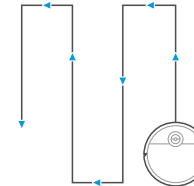

Suction increase

Increases the suction power.



- 1 Before using remote, insert the 2 included AAA batteries. Remove back battery cover and insert in correct orientation.
- 2 To prevent the robot from accidentally falling down stairs, there is no backwards direction.

Power ON/OFF

- 1 Open the cover and slide power switch to on.

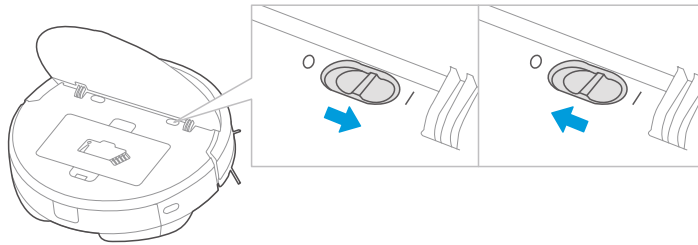

Clean/Pause

Clean

- 1 Ensure the power switch is in the "ON" position.

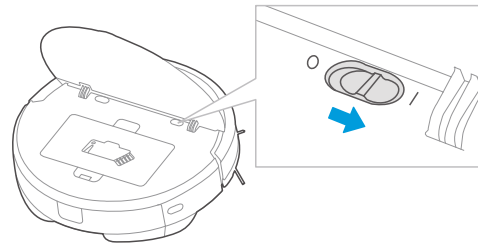

- 2 To begin cleaning, use one of the options below:
 - a. Press the "⏻" key to start cleaning.
 - b. Press the Start/Pause button on the remote.
 - c. Press the Start button on the APP.

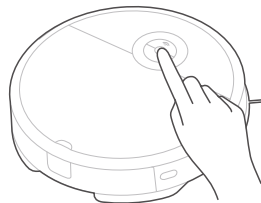

NOTE

The robot will enter a sleep mode if it is not used for an extended period of time. Press the "⏻" button to wake the robot, and then use one of the options above to start cleaning.

Pause

When robot is working, press the "⏻" and it will stop cleaning.

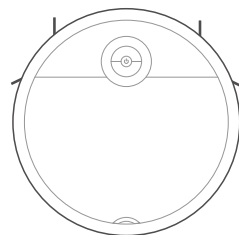

Using APP

NOTE

If your home wireless network name or password is changed, you will need to re-established connection with your robot vacuum.

1. App supports iOS 9.0 and above, Android 6.0 and above phone system versions, but Pad device is not accepted; generally the phone system version may be checked by clicking "Setting- About Mobile Phone".
2. This model does not support WEP encrypted router.
3. The network accessing configuration of the cleaner requires wireless network of 2.4GHz frequency range, 5GHz frequency range is currently incompatible.
4. Wireless network is mandatory for network accessing configuration of the cleaner; once the network accessing is configured successfully, App may be operated in wireless network/2G/3G/4G/5G network environment and the cleaner may be controlled remotely.
5. If your home wireless network password is changed, the cleaner will be displayed as off-line on App; Without any changes of App account number, one just needs to configure network accessing for the cleaner once again.
6. If others want to use App to operate same cleaner, they need to be invited on App by the device owner by sharing the device to the new user's account (on the condition that the invitee has downloaded App and has registered an account).
7. The device will be removed from the former device owner's device list if a new account owner connect the device successfully.
8. Once the cleaner is configured successfully network accessing, the following operations will result in clearance of wireless network settings and secondary network accessing configuration is required; Long press the network accessing configuration key on the device for over 3 seconds, and after a tick sound is heard, all wireless network information will be cleared.

- 1 Ensure mobile phone is connected to your home wireless network 
- 2 Download the **MSmartHome** app and register your vacuum:
 - a. Scan the QR code or search for the **MSmartHome** app in the Apple or Google Play store. Download the app.
 - b. Open the app and create your personal account. Follow instructions on the screen.



- 3 Add your robot vacuum to your app
Press the "+" button on the main screen of the app and select i5C from the available list of products.

- 4 Connect your robot to your wireless network
After assembling and powering on the robot, press and hold down the "⏻" button for 3 seconds until a beep is heard. The indicator light should start to flicker. Follow instructions on app for next steps.

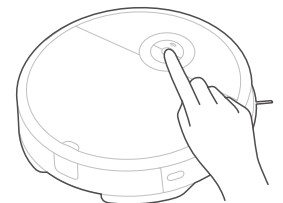

NOTE

Once the network access is configured successfully, you will be the owner of this cleaner and can operate your security intelligent cleaner by accessing to cleaner operating interface.

Mopping

- 1 Attach the mopping pad to the holder.

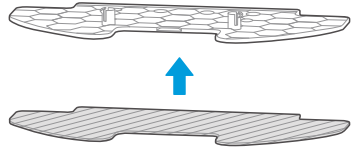

- 2 Press the button on tank and pull to remove.

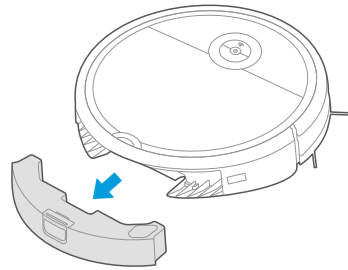

- 3 Fill the water.

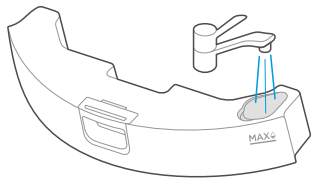

- 4 Attach mopping pad and holder to the water tank.

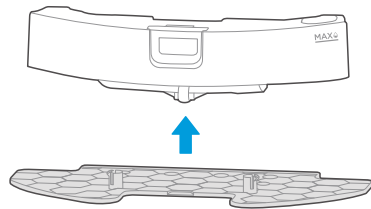

- 5 Reinsert the water tank assembly into the vacuum.

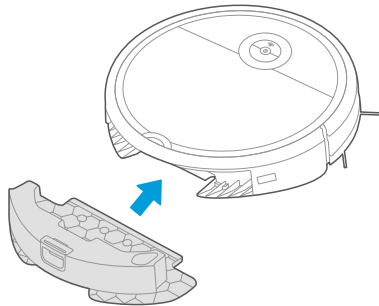

- 6 Press "⏻" to start mopping.

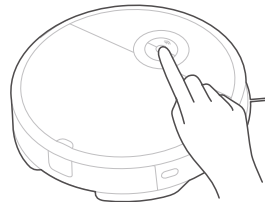

NOTE

- 1 It is recommended to fill the water tank 80% full before mopping for the first time.
- 2 It is recommended to use tap water in the water tank. Do not use any cleaning solutions.
- 3 It is recommended to observe the robot when mopping to ensure it does not go onto carpet.

PRODUCT MAINTENANCE

Cleaning the Side Brush

- 1 Regularly check the side brush for hair wrapping.
- 2 Clean the side brush with the cleaning tool or a rag.
- 3 If the side brush has deformed from hair wrap, remove the side brush by pulling it off of the vacuum and place it in warm water for 5 seconds.
- 4 If the side brush is permanently damaged, replace with the spare set of brushes.



Cleaning the Dust Bin, Sponge and Filter

NOTE

- 1 Empty the dust bin after each use.
- 2 Wash the filter and sponge ever 2-4 weeks.

- 1 Open the cover.

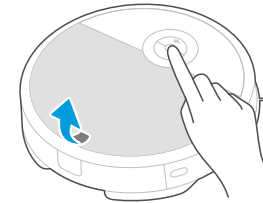

- 2 Press the dust bin removal button and lift out the dust bin.

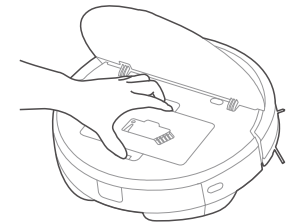

- 3 Press dust release button to empty into a trash bin.

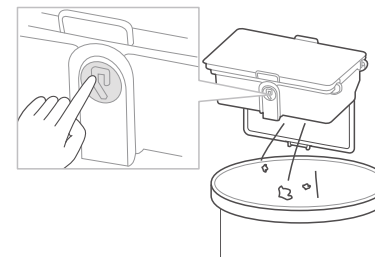

- 4 Lift open the top of the dust bin to access the spare filter.

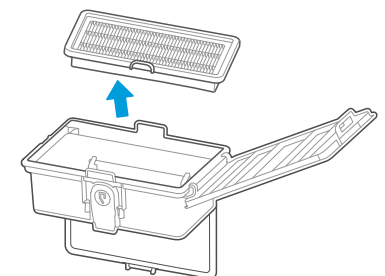

5 Rinse the dust bin, sponge, and filter with warm water. dry THOROUGHLY for 24 hrs.

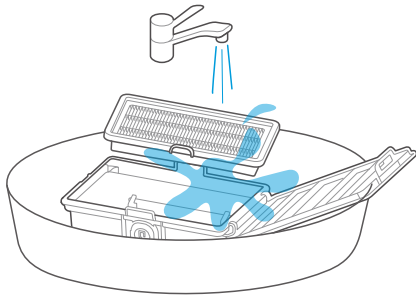

6 Replace the spare filter holder back into the dust bin.

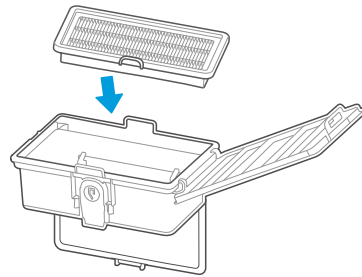

Cleaning the Water Tank

1 Once finished mopping, press the water tank release button and pull to remove the water tank. Detach the mop holder and mopping pad by pulling them apart.

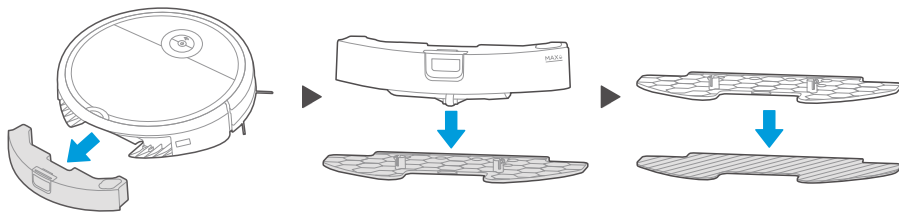

2 Wash the mopping pad and dry THOROUGHLY

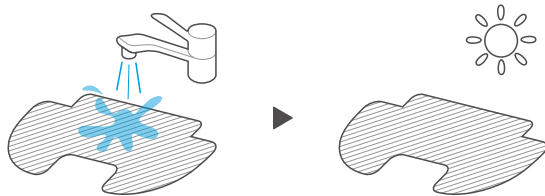

3 Lift open the Pour out the remaining water from the water tank.



4 Wipe dry the water tank and set aside. Exposure to sunlight is not recommended.



Cleaning the Sensor and Wheel

Wipe the sensor and wheels gently with a soft cloth, as shown in the figure below.

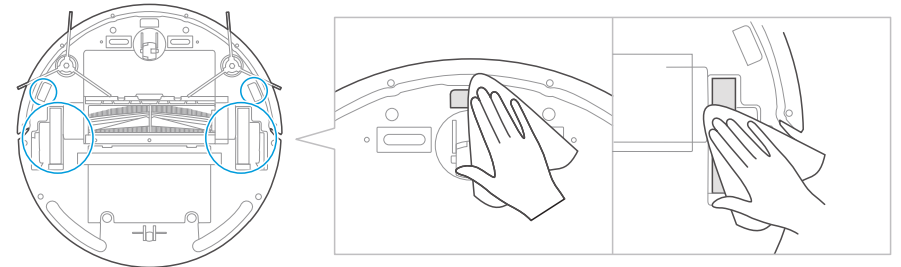

Cleaning the Charge Terminal

Wipe the charging terminals on both the robot and charging dock with a soft cloth, as shown in the figure below.

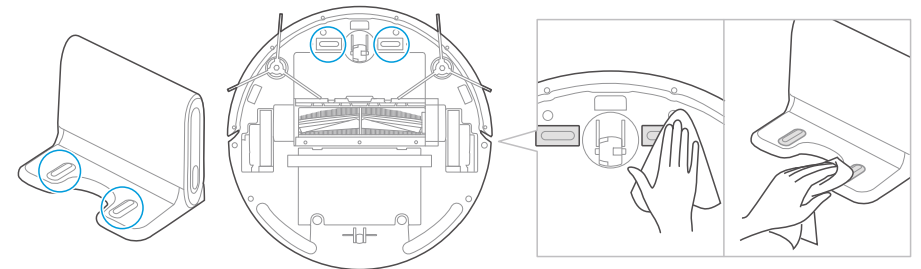

Cleaning the Brushroll

- 1 With the vacuum turned upside down, place your thumb in the open slot between the two tabs and lift off to remove brushroll cover.

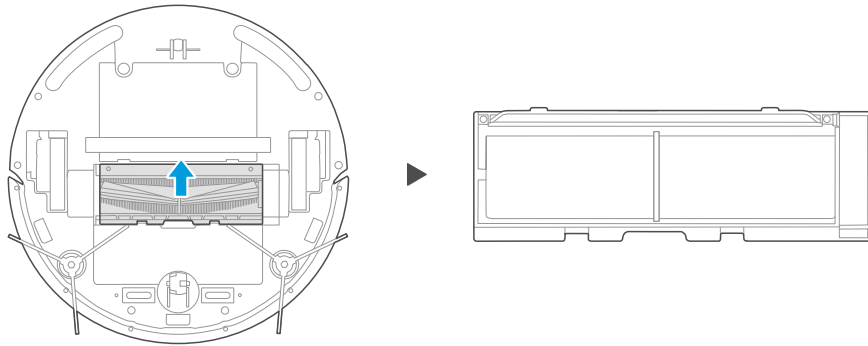

- 2 Press brushroll lock and lift up to access brushroll.

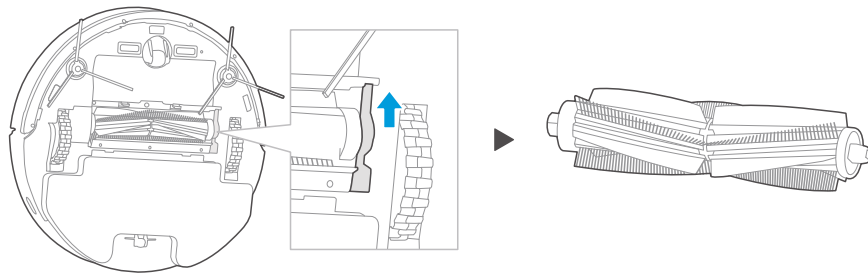

- 3 Clean the brushroll with a soft cloth or warm water. Dry THOROUGHLY and reinstall.

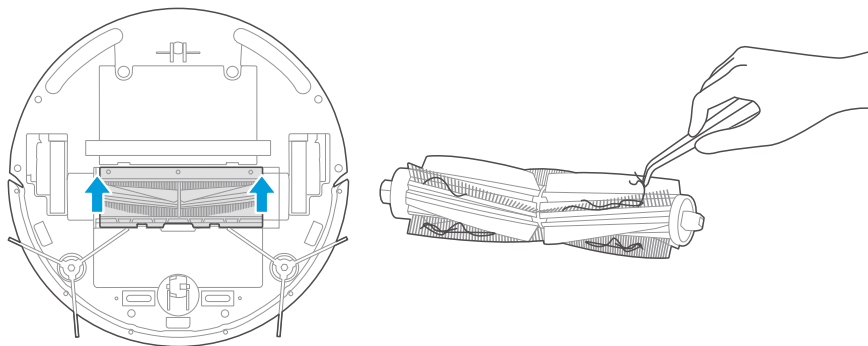

TROUBLE SHOOTING

In case of mis-function, please refer to the following table.

Problem	Possible reason	Solution
The appliance will not be charged	<ul style="list-style-type: none"> ▶ The power switch is not turned on while charging. ▶ The appliance and charging terminals are not in full contact. 	<ul style="list-style-type: none"> ▶ Power on the appliance . ▶ Make sure the appliance is fully in contact with the charging terminal.
The appliance gets stuck	<ul style="list-style-type: none"> ▶ The appliance is covered by wires on the ground, drooping curtain fabric or blankets are twined. ▶ Side brush and brushroll, etc. get stuck, and the appliance cannot run normally. 	<ul style="list-style-type: none"> ▶ The appliance will automatically start the escape mode. If it is not out of trouble, it needs manual help. ▶ Clean the windings on the side brush and restart it. If not, contact the after-sales department.
Not cleaned completely, and recharge it	<ul style="list-style-type: none"> ▶ The appliance does not sense enough battery power. 	<ul style="list-style-type: none"> ▶ Charge the appliance.
No cleaning according to the preset time	<ul style="list-style-type: none"> ▶ The power switch is not on. ▶ Scheduled appointment is cancelled. 	<ul style="list-style-type: none"> ▶ Turn on the power switch of appliance. ▶ Reset and make appointment.
After the mop holder is installed, the appliance is impermeable	<ul style="list-style-type: none"> ▶ The mop holder magnet falls off. ▶ There's no water in water tank. ▶ The appliance base outlet hole is blocked. 	<ul style="list-style-type: none"> ▶ Contact the aftersales service center. ▶ Add water. ▶ Clear water outlet and tank filter.
The appliance has missed sweeps, there is no plan for cleaning, and the map in app shows irregularly	<ul style="list-style-type: none"> ▶ The ground is slippery. ▶ Wires, shoes and other objects placed on the ground, affecting the normal operation of the appliance. ▶ Cleaning is interrupted halfway. 	<ul style="list-style-type: none"> ▶ If the floor is waxed, dry it before use. ▶ Minimize ground items as much as possible. ▶ Do not move or block the appliance during work.
Appliance does not work	<ul style="list-style-type: none"> ▶ The power switch is not turned on. ▶ Low battery. ▶ Wheels are dropped and the three groups of drop sensors are in a falling state. 	<ul style="list-style-type: none"> ▶ Turn on the power switch. ▶ Charge the appliance. ▶ Place the appliance close to the ground. ▶ Contact aftersales service center.
Appliance retreats	<ul style="list-style-type: none"> ▶ There's obstacle ahead. ▶ Bumper rail is clamped. 	<ul style="list-style-type: none"> ▶ Clear the front obstacles. ▶ Tap the bumper rail to check for if there's foreign matter stuck.

TROUBLE SHOOTING

In case of mis-function, please refer to the following table.

Problem	Cause	Troubleshooting	Solution
App displays disconnection	Disconnection between the mobile phone and the equipment	<ul style="list-style-type: none"> ▶ Judge if the mobile phone is accessed to network; ▶ Judge if the router works normally; ▶ The cleaner is required to be powered; ▶ The wireless network configurations of the equipment are cleared; ▶ The wireless network password or network is changed. 	<ul style="list-style-type: none"> ▶ The mobile phone shall be accessed to network once again; ▶ Re-start the router; ▶ Power on the cleaner once again; ▶ Add new appliances into App; ▶ After system start-up, long press "⏻" 3 seconds and release it after a tick sound is heard; clear all network configurations of the cleaner and add household electrical appliances once again for operation.
Slow App operation	Network connection is not so smooth	<ul style="list-style-type: none"> ▶ Network busy; ▶ Poor network signal reception of the mobile phone; ▶ The network bandwidth is not so adequate. 	<ul style="list-style-type: none"> ▶ Re-start the router and reduce the number of access users; ▶ Check the settings of the mobile phone itself; ▶ Broaden network bandwidth.
The QR code of the mobile phone itself cannot be scanned by App.	The hardware configurations of the mobile phone are very low, the camera has no focus function.	<ul style="list-style-type: none"> ▶ Change mobile phones for confirmation; 	<ul style="list-style-type: none"> ▶ Change mobile phones and scan; ▶ Add equipment by product category.