

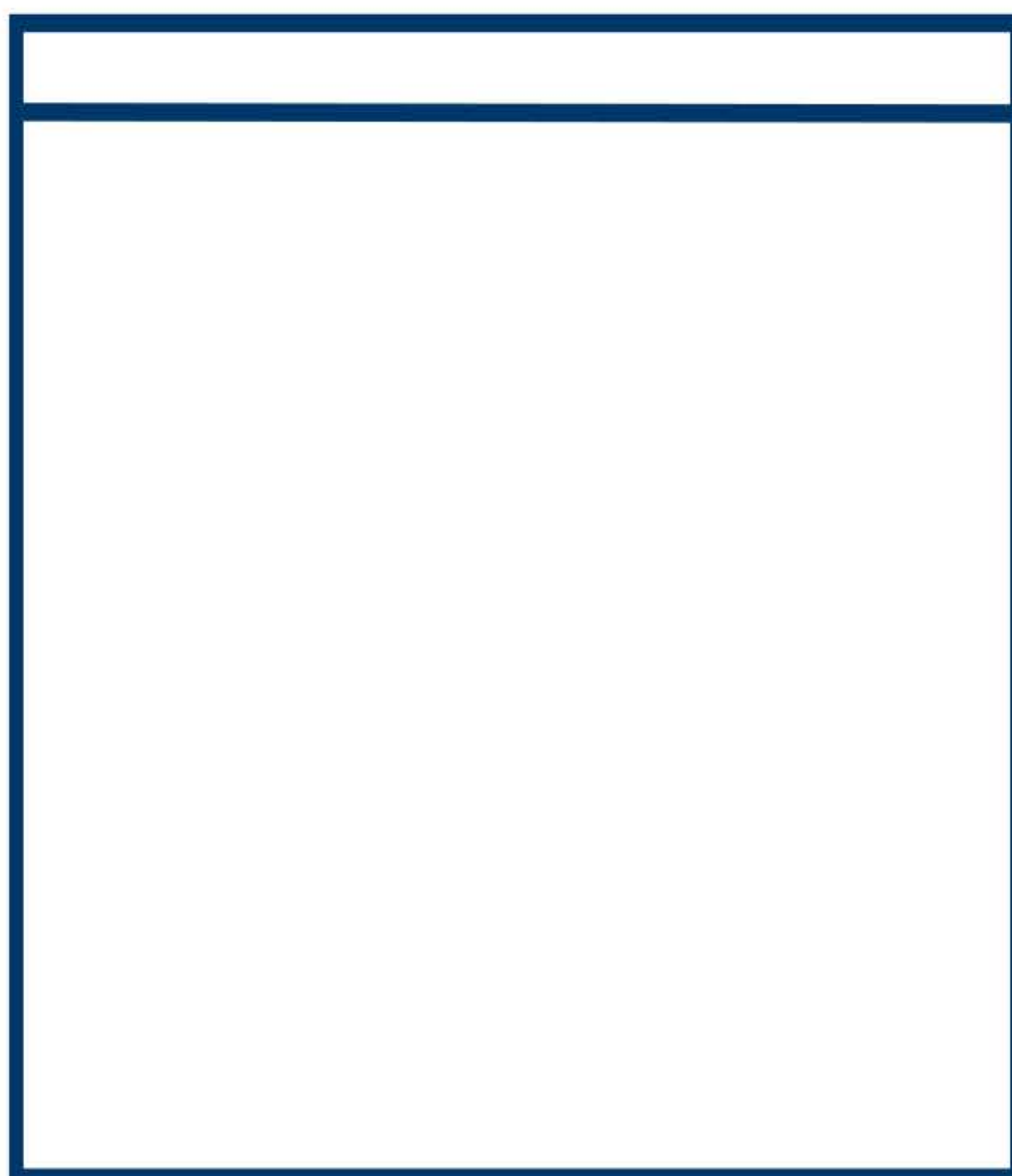

EN

CHEST FREEZER

USER MANUAL



Please read the Manual carefully before use.
The Manual shall be kept in good custody for later reference

**MODEL: MDRC152FZG01-SG
MDRC207FZG01-SG
MDRC280FZG01-SG
MD-RC143-CCDMF01
MD-RC199-CCDMF01**

www.midea.com

CONTENTS

1	Safety warnings	
1. 1	Warning	1-2
1. 2	Meaning of safety warning symbols	3
1. 3	Electricity related warnings	3
1. 4	Related warnings for use	4
1. 5	Warnings related to placing items	5
1. 6	Warnings for energy	5
1. 7	Warnings related to disposal	5
2	Proper use of freezer	
2. 1	Names of components	6
2. 2	Temperature Control	7
2. 3	Placement	8
2. 4	Start to use	8
2. 5	Energy saving tips	8
3	Maintenance of freezer	
3. 1	Cleaning	9
3. 2	Defrost	9
3. 3	Stop using	9
4	Trouble shooting	10

DEAR CUSTOMER:

Thank you for buying this freezer. To ensure that you get the best results from your new freezer, please take time to read through the simple instructions in this booklet. Please ensure that the packing material is disposed of in accordance with the current environmental requirements. When disposing of any freezer equipment please contact your local waste disposal department for advice on safe disposal. This appliance must be only used for its intended purpose.

1 Safety warnings

1.1 Warning



Warning: risk of fire / flammable materials

THIS appliance is intended to be used in household and similar applications such as staff kitchen areas in shops, offices and other working environments; farm houses and by clients in hotels, motels and other residential type environments; bed and breakfast type environments; catering and similar non-retail applications.

THIS appliance is not intended for use by persons (including children) with reduced physical, sensory or mental capabilities, or lack of experience and knowledge, unless they have been given supervision or instruction concerning use of the appliance by a person responsible for their safety.)

IF the supply cord is damaged, it must be replaced by the manufacturer, its service agent or similarly qualified persons in order to avoid a hazard.

DO not store explosive substances such as aerosol cans with a flammable propellant in this appliance.

THE appliance has to be unplugged after use and before carrying out user maintenance on the appliance.

WARNING: Keep ventilation openings, in the appliance enclosure or in the built-in structure, clear of obstruction.

WARNING: Do not use mechanical devices or other means to accelerate the defrosting process, other than those recommended by the manufacturer.

WARNING: Do not damage the refrigerant circuit.

WARNING: Do not use electrical appliances inside the food storage compartments of the appliance, unless they are of the type recommended by the manufacturer.

WARNING: Please abandon the refrigerator according to local regulators for it use flammable blowing gas and refrigerant.

WARNING: When positioning the appliance, ensure the supply cord is not trapped or damaged.

WARNING: Do not locate multiple portable socket-outlets or portable power supplies at the rear of the appliance.

DO not use extension cords or ungrounded (two prong) adapters.

DANGER: Risk of child entrapment. Before you throw away your old refrigerator or freezer:

–Take off the doors.

–Leave the shelves in place so that children may not easily climb inside.

THE refrigerator must be disconnected from the source of electrical supply before attempting the installation of accessory.

REFRIGERANT and cyclopentane foaming material used for the appliance are flammable. Therefore, when the appliance is scrapped, it shall be kept away from any fire source and be recovered by a special recovering company with corresponding qualification other than be disposed by combustion, so as to prevent damage to the environment or any other harm.

CHILDREN should be supervised to ensure that they do not play with the appliance.

FOR EN standard: This appliance can be used by children aged from 8 years and above and persons with reduce physical sensory or mental capabilities or lack of experience and knowledge if they have been given supervision or instruction concerning use of the appliance in a safe way and understand the hazards involved. Children shall not play with the appliance. Cleaning and user maintenance shall not be made by children without supervision. Children aged from 3 to 8 years are allowed to load and unload refrigerating appliances.

TO avoid contamination of food , please respect the following instructions:

- Opening the door for long periods can cause a significant increase of the temperature in the compartments of the appliance.
- Clean regularly surfaces that can come in contact with food and accessible drainage systems.
- Clean water tanks if they have not been used for 48 h; flush the water system connected to a water supply if water has not been drawn for 5 days. (note 1)
- Store raw meat and fish in suitable containers in the refrigerator, so that it is not in contact with or drip onto other food.
- Two-star ****** frozen-food compartments are suitable for storing pre-frozen food, storing or making ice-cream and making ice cubes. (note 2)
- One ***** -, two ****** -and three-star ******* compartments are not suitable for the freezing of fresh food.
□ note 3□
- If the refrigerating appliance is left empty for long periods, switch off, defrost, clean, dry, and leave the door open to prevent mould developing within the appliance.



Note 1,2,3: Please confirm whether it is applicable according to your product compartment type.

WARNING: To avoid a hazard due to instability of the appliance, it must be fixed in accordance with the instructions.

WARNING: Connect to potable water supply only. (Suitable for ice making machine)

TO Prevent A Child From Being Entrapped, Keep Out Of Reach Of Children And Not In The Vicinity Of Freezer (Or Refrigerator)." (Suitable for products with locks)

1.2 Meaning of safety warning symbols

	The symbols indicate prohibited matters, and those behaviors are forbidden. Non-compliance with the instructions may result in product damages or endanger the personal safety of users.
Prohibition symbols	
	The symbols indicate matters that must be followed, and those behaviors must be strictly executed in line with the operation requirements. Non-compliance with the instructions may result in product damages or endanger the personal safety of users.
Warning symbols	
	The symbols indicate matters to pay attention to, and these behaviors shall be specially noted. Due precautions are needed or minor or moderate injuries or damages of the product will be caused.
Note symbols	

This manual contains lots of important safety information which shall be observed by the users.

1.3 Electricity related warnings

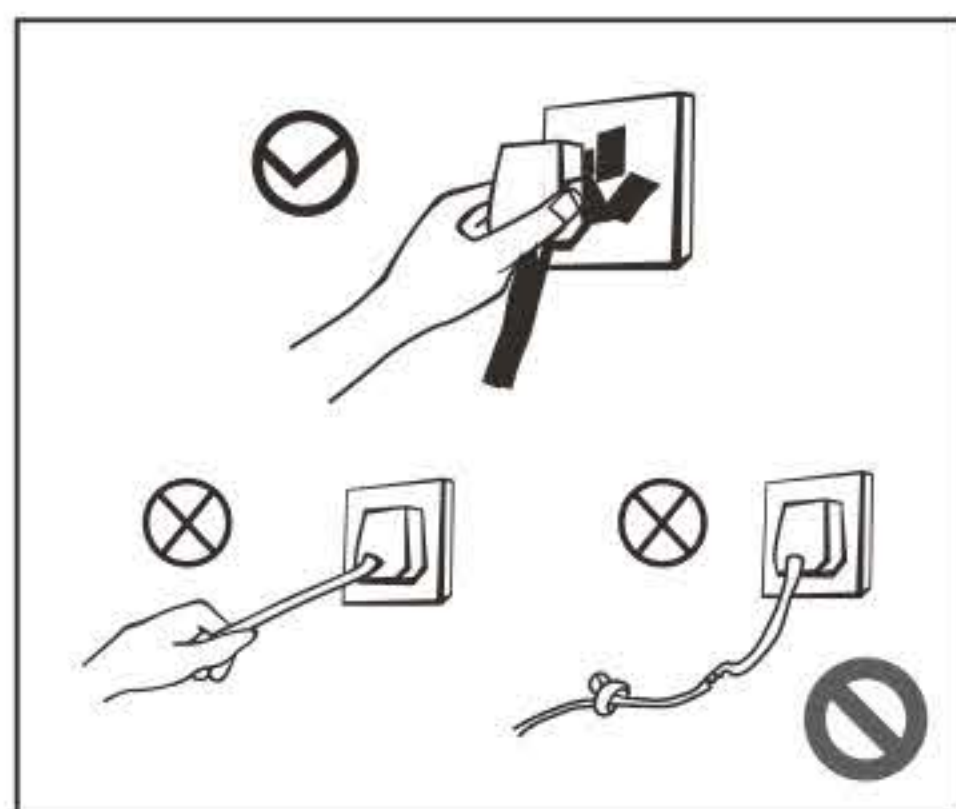

- Do not pull the power cord when pulling the power plug of the freezer. Please firmly grasp the plug and pull out it from the socket directly.
- Do not damage the power cord under any condition so as to ensure safety use, do not use when the power cord is damaged or the plug is worn.
- Worn or damaged power cord shall be replaced in manufacturer-authorized maintenance stations.

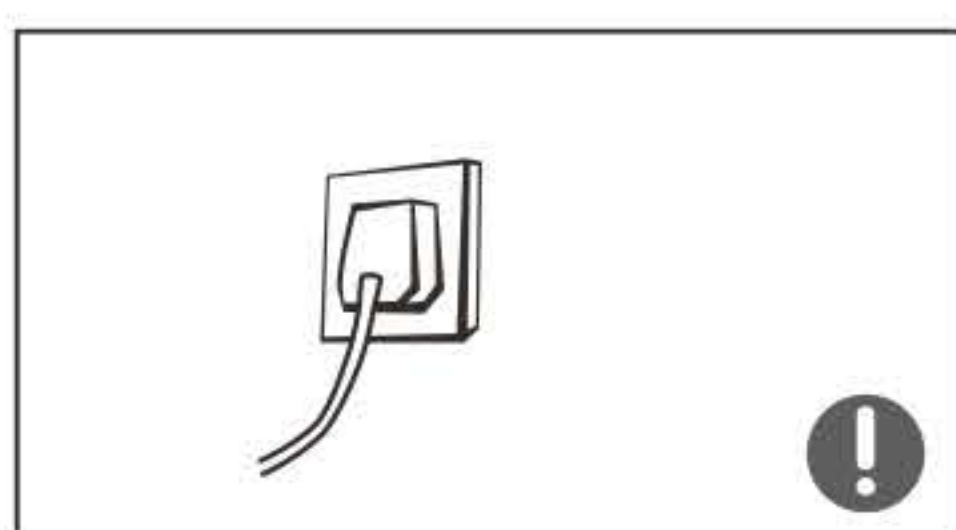

- The power plug should be firmly contacted with the socket or else fires might be caused. Please ensure that the grounding electrode of the power socket is equipped with a reliable grounding line.

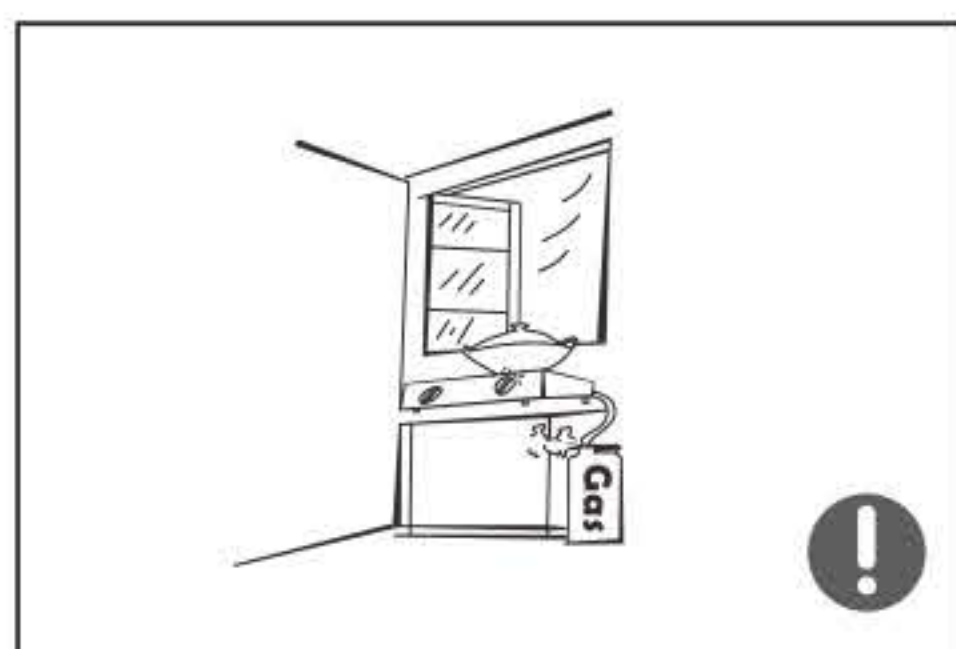

- Please turn off the valve of the leaking gas and then open the doors and windows in case of leakage of gas and other flammable gases. Do not unplug the freezer and other electrical appliances considering that spark may cause a fire.

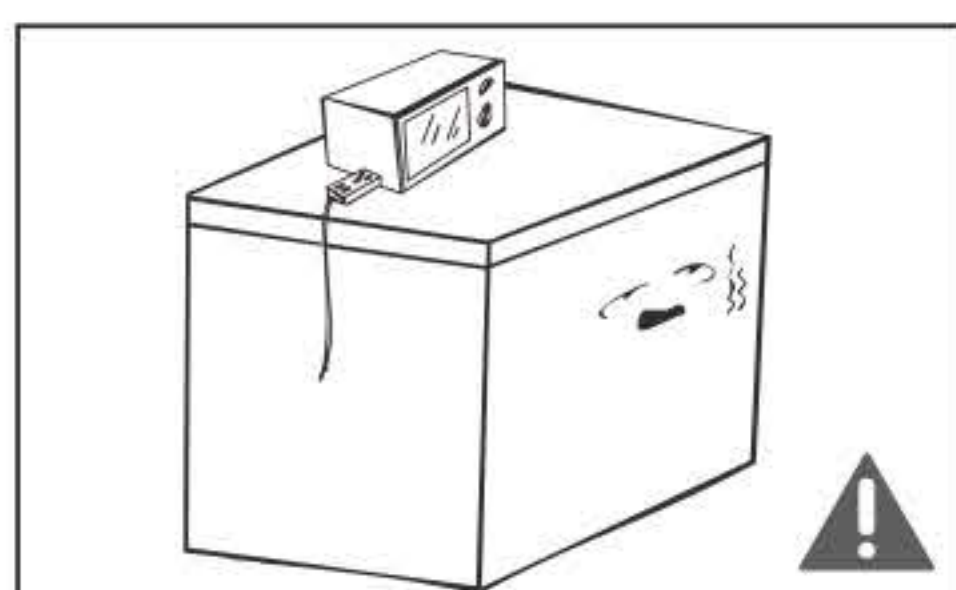

- To ensure safety, it is not recommended that to place regulators, rice cookers, microwave ovens and other appliances on the top of the freezer, those recommended by the manufacturer are not included. Do not use electrical appliances in the food pan.

1.4 Related warnings for use

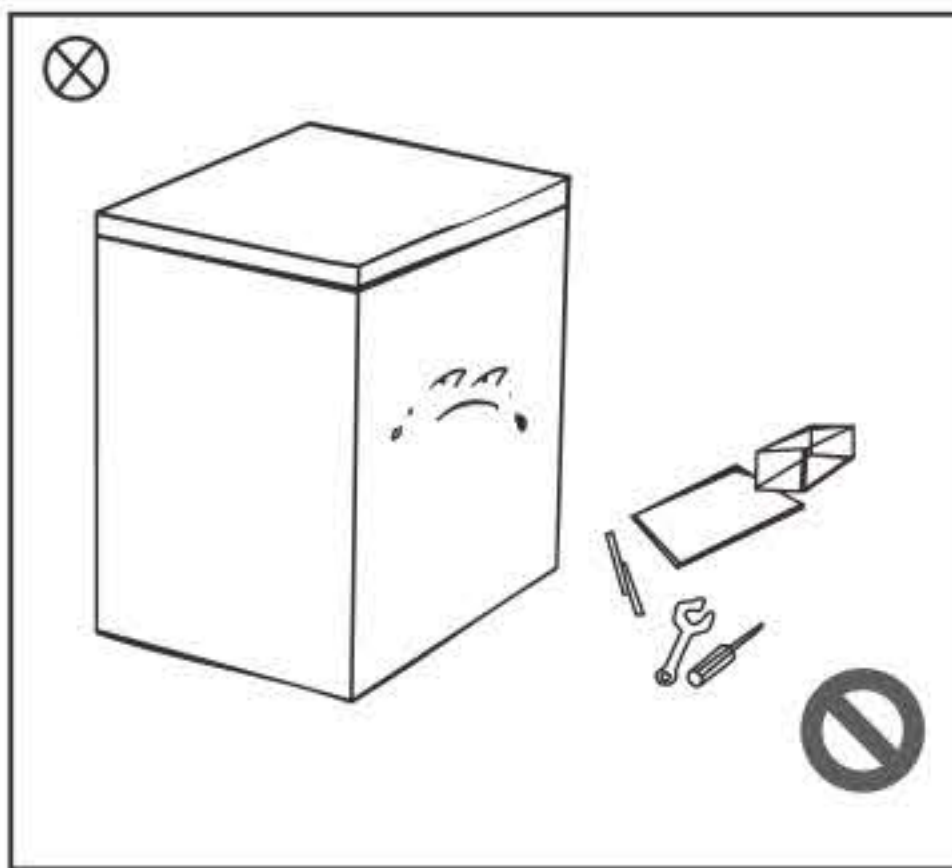

- Do not arbitrarily disassemble or reconstruct the freezer, nor damage the refrigerant circuit; maintenance of the appliance must be conducted by a specialist.
- Damaged power cord must be replaced by the manufacturer, its maintenance department or related professionals in order to avoid danger.

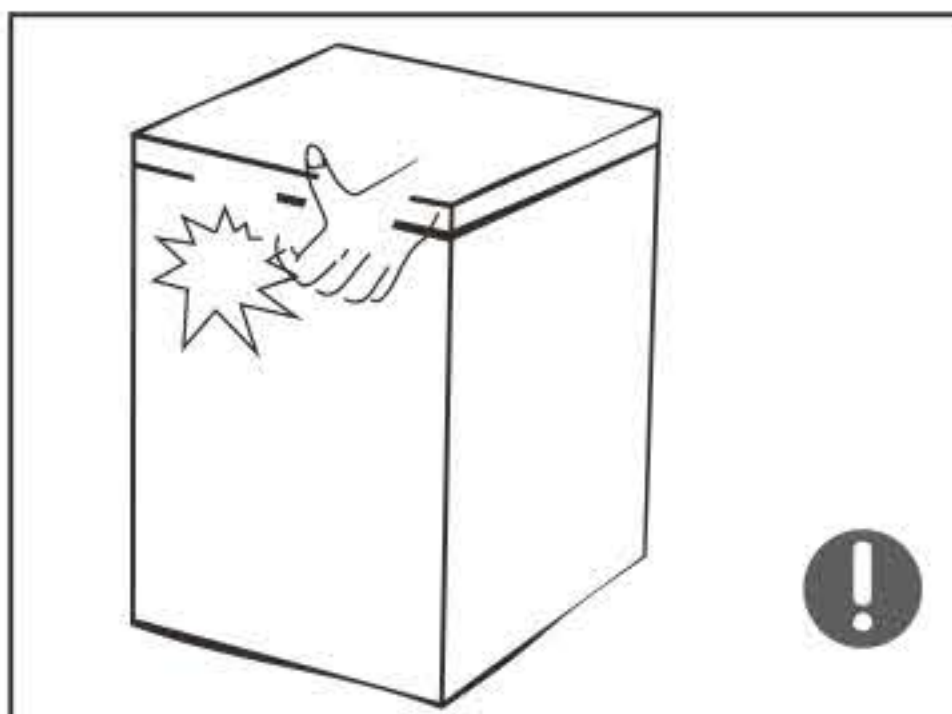

- The gaps between freezer doors and between doors and freezer body are small, be noted not to put your hand in these areas to prevent from squeezing the finger. Please be gentle when open the freezer door to avoid falling articles.
- Do not pick foods or containers with wet hands in the freezing chamber when the freezer is running, especially metal containers in order to avoid frostbite.



- Do not allow children to enter or climb the freezer to prevent that children are sealed in the freezer or children are injured by the falling freezer.
- Do not spray or wash the freezer; do not put the freezer in moist places easy to be splashed with water so as not to affect the electrical insulation properties of the freezer.

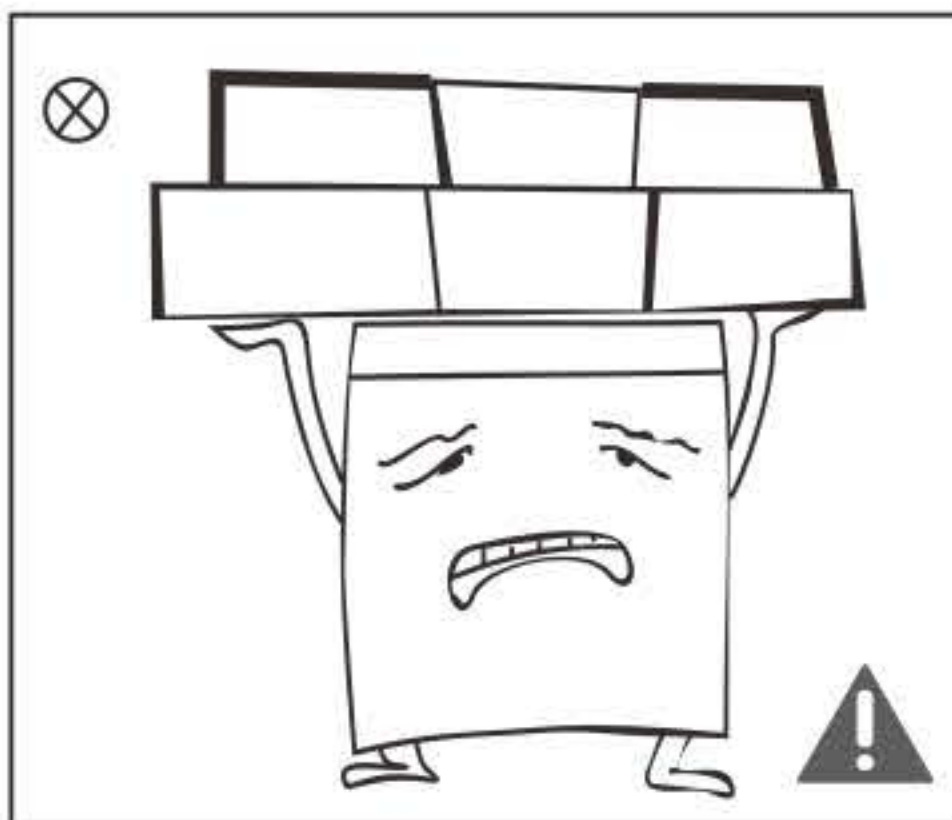

- Do not place heavy objects on the top of the freezer considering that objects may fall when open the door, and accidental injuries might be caused.
- Please pull out the plug in case of power failure or cleaning. Do not connect the freezer to power supply within five minutes to prevent damages to the compressor due to successive starts.

1.5 Warnings related to placing items

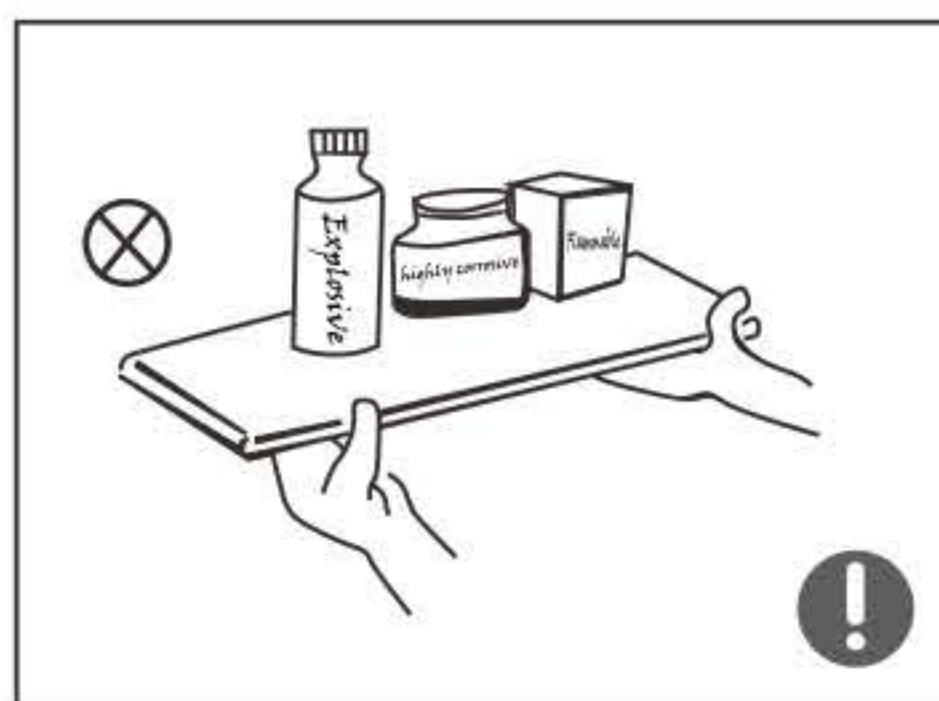

- Do not put flammable, explosive, volatile and highly corrosive items in the freezer to prevent damages to the product or fire accidents.
- Do not place flammable items near the freezer to avoid fires.

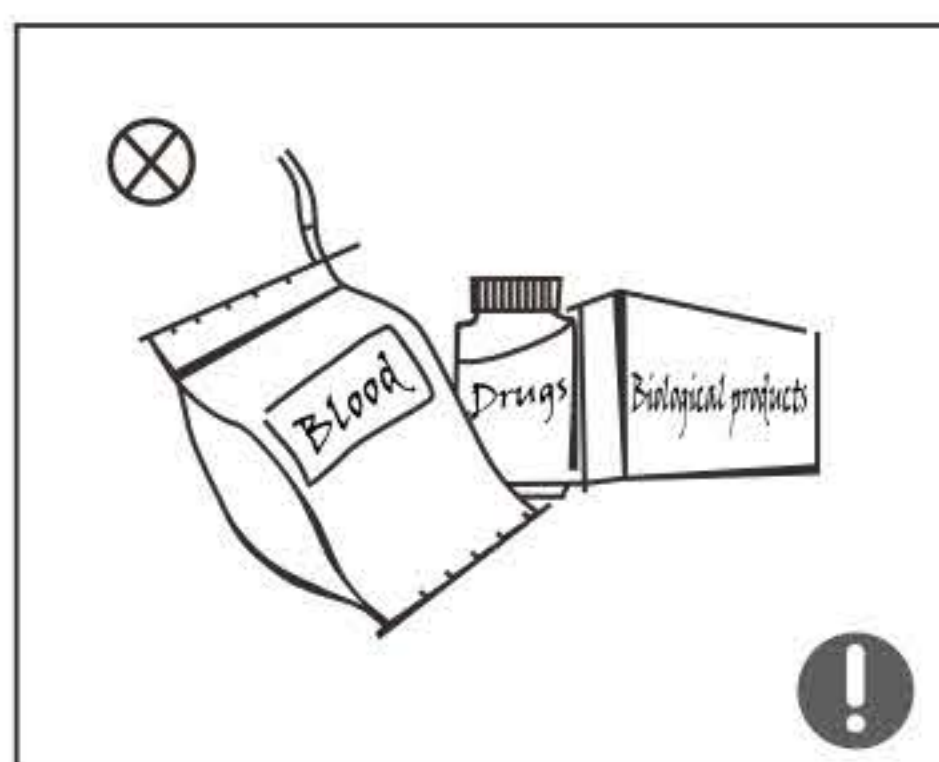

- This product is household freezer and shall be only suitable for the storage of foods. According to national standards, household freezer shall not be used for other purposes, such as storage of blood, drugs or biological products.

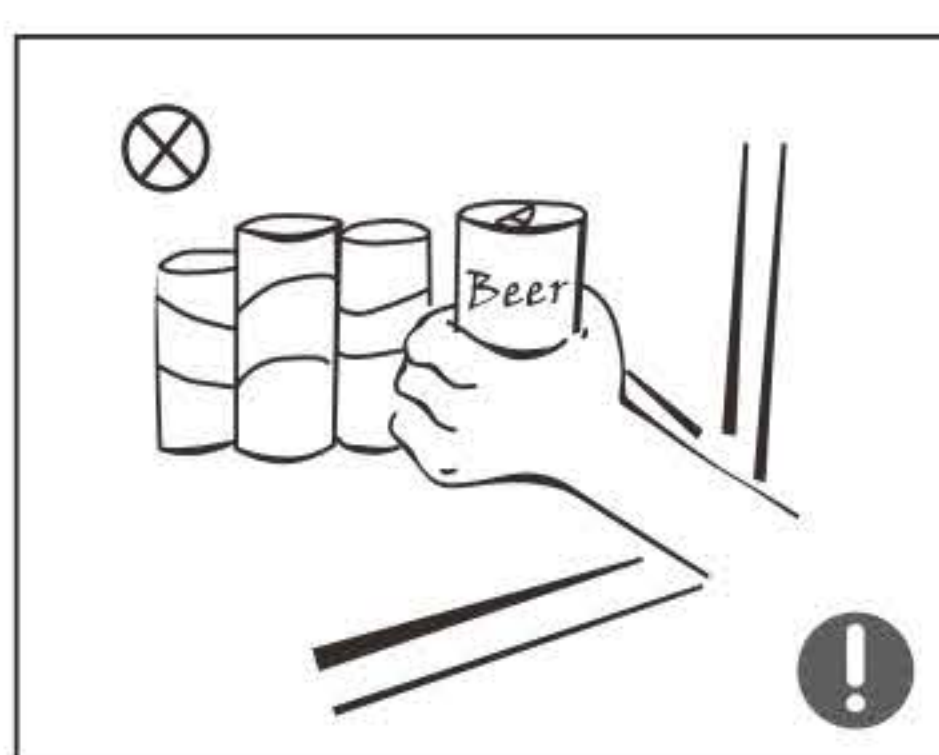

- Do not place items such as bottled or sealed container of fluid such as bottled beers and beverages in the freezer to prevent bursts and other losses.

1.6 Warnings for energy

- 1) Freezer might not operate consistently when sited for an extended period of time below the cold end of the range of temperatures for which the freezer appliance is designed.
- 2) The fact that effervescent drinks should not be stored in food freezer compartments or cabinets or in low-temperature compartments or cabinets, and that some products such as water ices should not be consumed too cold;
- 3) The need to not exceed the storage time recommended by the food manufacturers for any kind of food and particularly for commercially quick-frozen food in food-freezer and frozen-food storage compartments or cabinets;
- 4) The precautions necessary to prevent an undue rise in the temperature of the frozen food while defrosting the refrigerating appliance, such as wrapping the frozen food in several layers of newspaper.
- 5) The fact that a rise in temperature of the frozen food during manual defrosting, maintenance or cleaning could shorten the storage life.
- 6) The necessity that, for doors or lids fitted with locks and keys, the keys be kept out of the reach of children and not in the vicinity of the freezer appliance, in order to prevent children from being locked inside.

1.7 Warnings related to disposal



The freezer's refrigerant and cyclopentane foam materials are combustible materials and discarded freezers should be isolated from fire sources and can not be burned. Please transfer the freezer to qualified professional recycling companies for processing to avoid damages to the environment or other hazards.



Please remove the door of the freezer and shelves which shall be properly placed to avoid accidents of children entering and playing in the freezer.



Correct Disposal of this product:

This marking indicates that this product should not be disposed with other household wastes. To prevent possible harm to the environment or human health from uncontrolled waste disposal, recycle it responsibly to promote the sustainable reuse of material resources. To return your used device, please use the return and collection systems or contact the retailer where the product was purchased. They can take this product for environmental safe recycling.

2 Proper use of freezer

2.1 Names of components

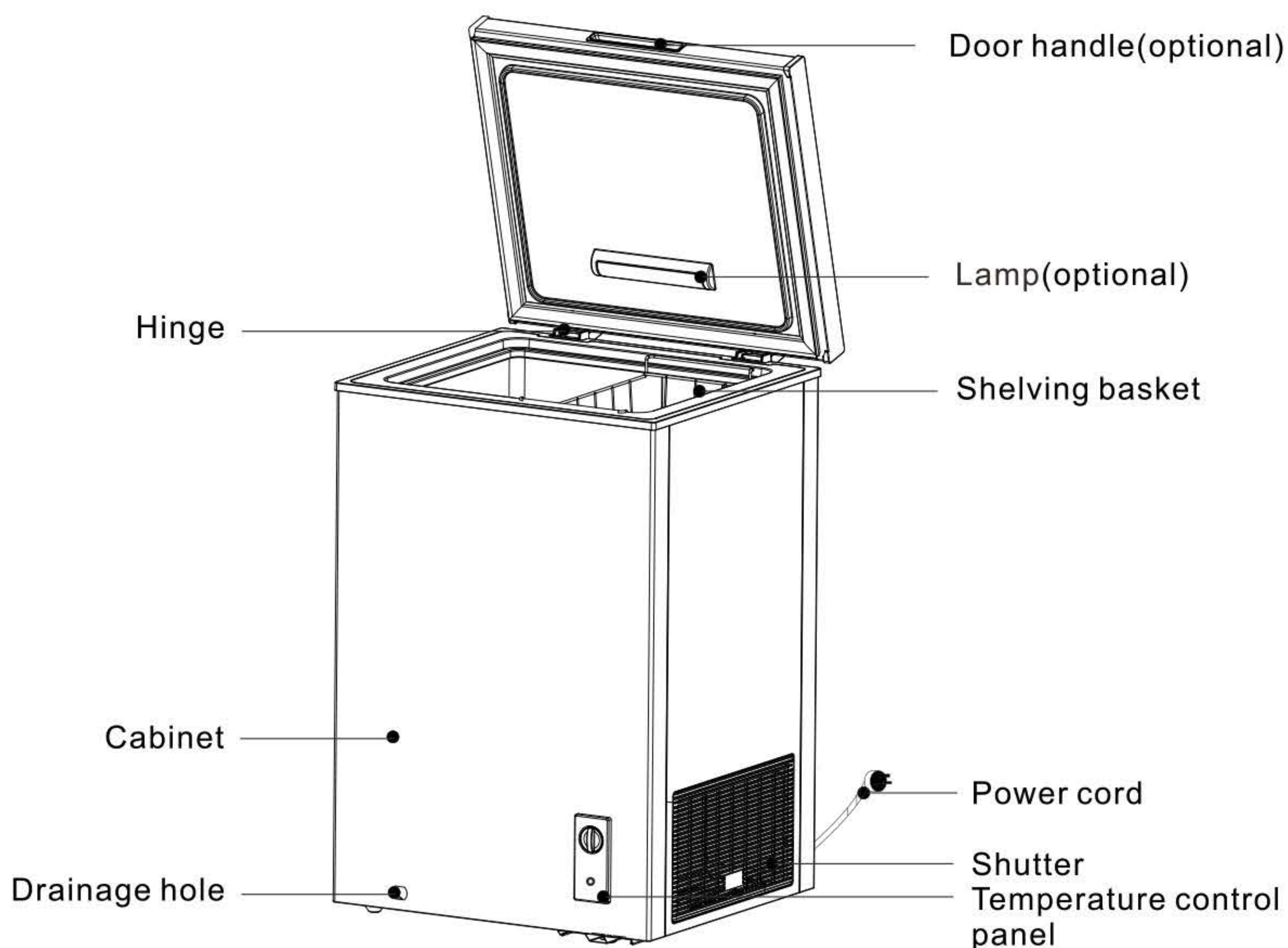

(The picture above is only for reference. The actual configuration will depend on the physical product or statement by the distributor)

- The low temperature of freezer may keep food fresh for a long time and it is mainly used to store frozen foods and making ice.
- The freezer is suitable for storage of meat, fish, shrimp, pastries class and other foods not to be consumed in short term.
- Chunks of meat are preferably to be divided into small pieces for easy access. Please be noted food shall be consumed within the shelf time.

Notice:

After long term using, there may be a certain degree of wear with the hinge, it will cause the noise when open/close the door and reduce the service life of hinge. It is recommended to put the grease on hinge for maintenance regularly, it can effectively eliminate noise and extend the service life of the hinge.

2.2 Temperature Control

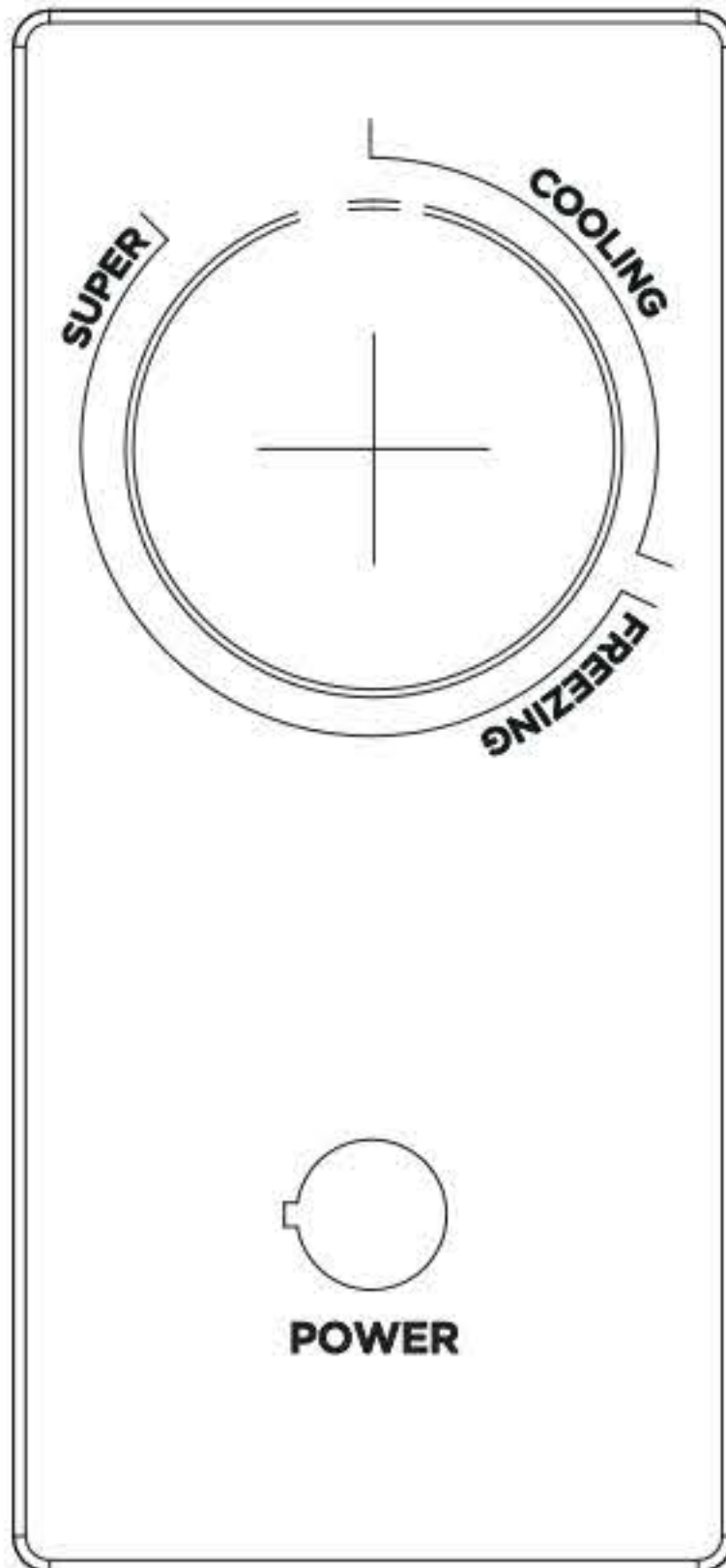

- Please electrify the chest freezer, the "POWER" lamp will shine(green light).
- Rotate the thermostat knob clockwise,the temperature inside chest freezer will be lower and lower.
- "COOLING " means cooling zone,"FREEZING--SUPER"means the freezing zone.
- When set the thermostat knob to "SUPER" position, the chest freezer enters into super freeze mode, during this mode the compressor keeps running without interruption.

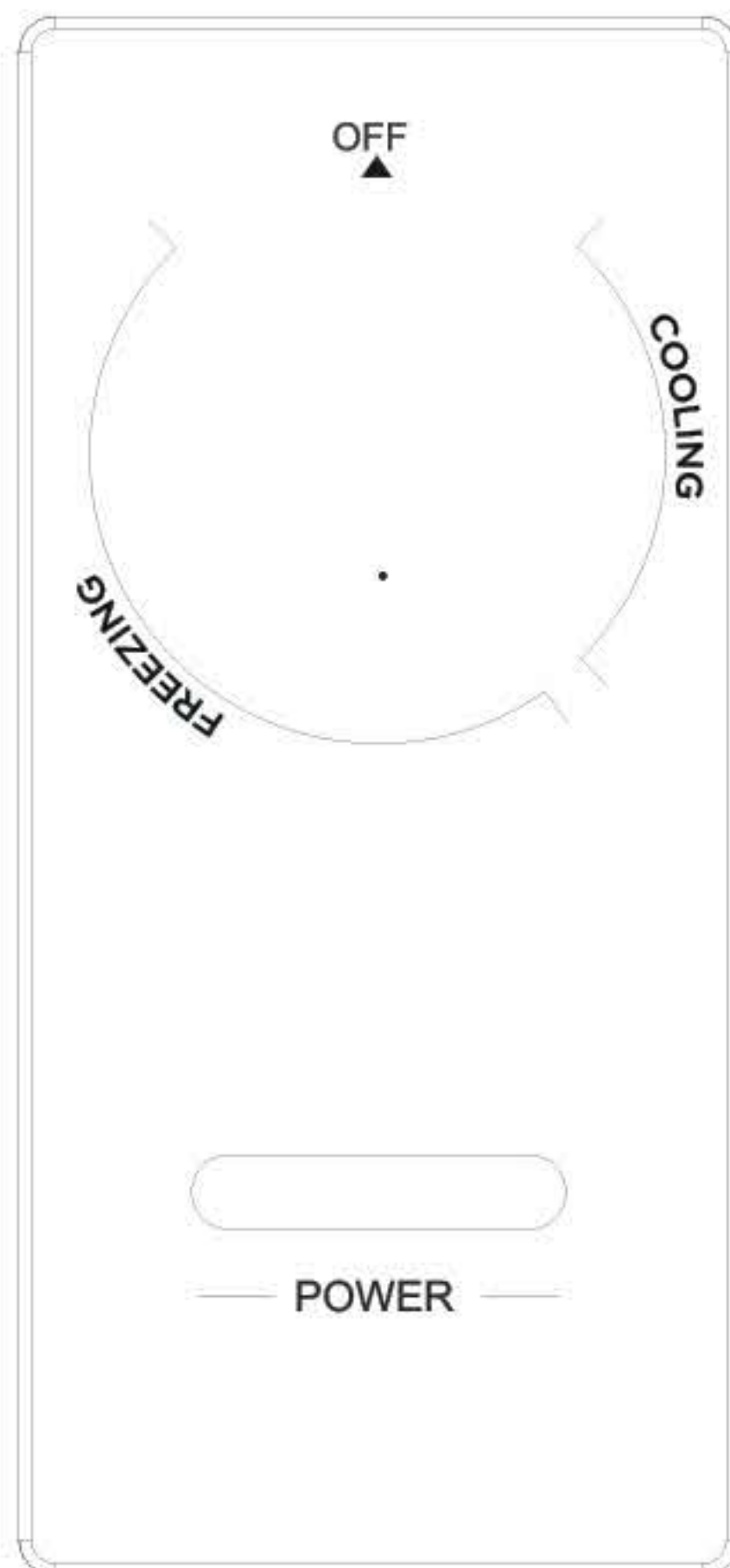

- After power on , the "POWER" indicator light will belight(blue).
- The temperature in the box is adjusted by the temperature control knob; when knob adjusted within the scope of "COOLING", the box is refrigerator;when knob is adjusted within the scope of "FREEZING , the box is frozen.The knob rotates clockwise to reduce the temperature in the box.
- "OFF" file indicates stop.

(The picture above is only for reference. The actual configuration will depend on the physical product or statement by the distributor)

2.3 Placement

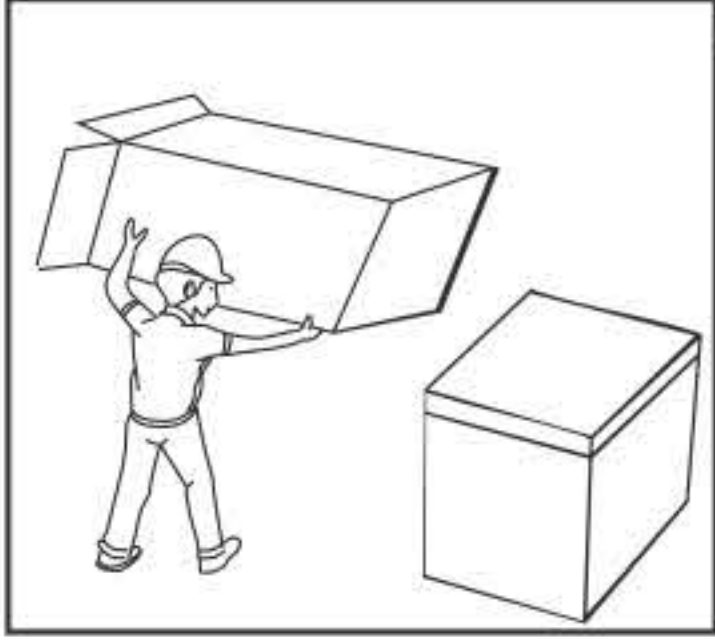

- Before using the freezer, remove all packaging materials including bottom cushions and foam pads and tapes inside the freezer, tear off the protective film on the door and the freezer body.

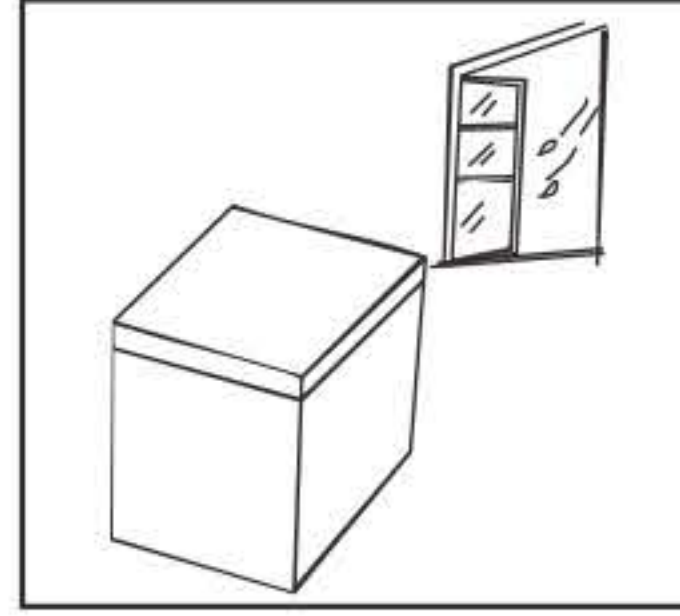

- The freezer should be placed in a well-ventilated indoor place; the ground shall be flat, and sturdy .

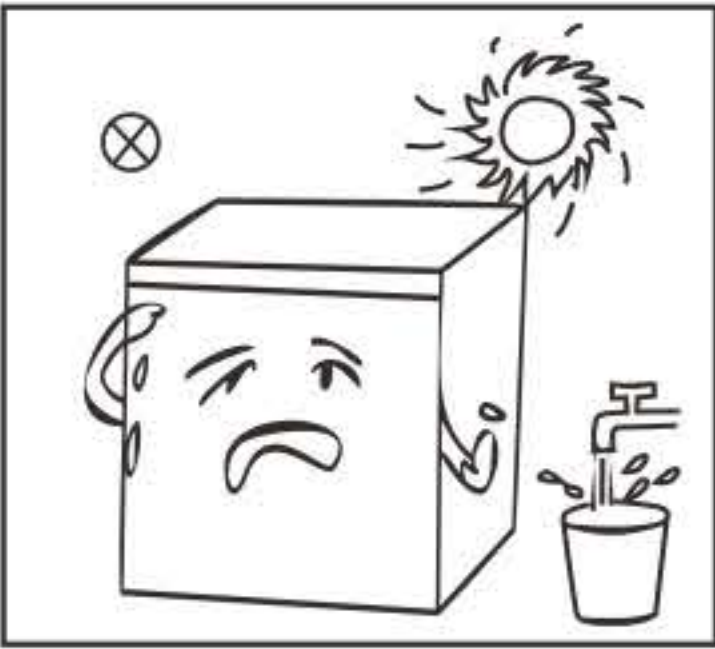

- Keep away from heat and avoid direct sunlight. Do not place the freezer in moist or watery places to prevent rust or reduction of insulating effect.

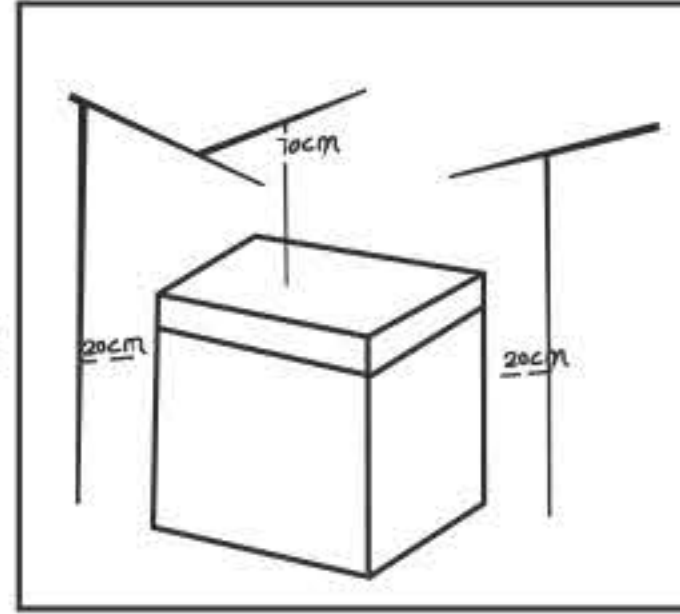

- The top space of the freezer shall be greater than 70cm, and the distances from both sides and backside shall be more than 20cm to facilitate heat dissipation.

2.4 Start to use

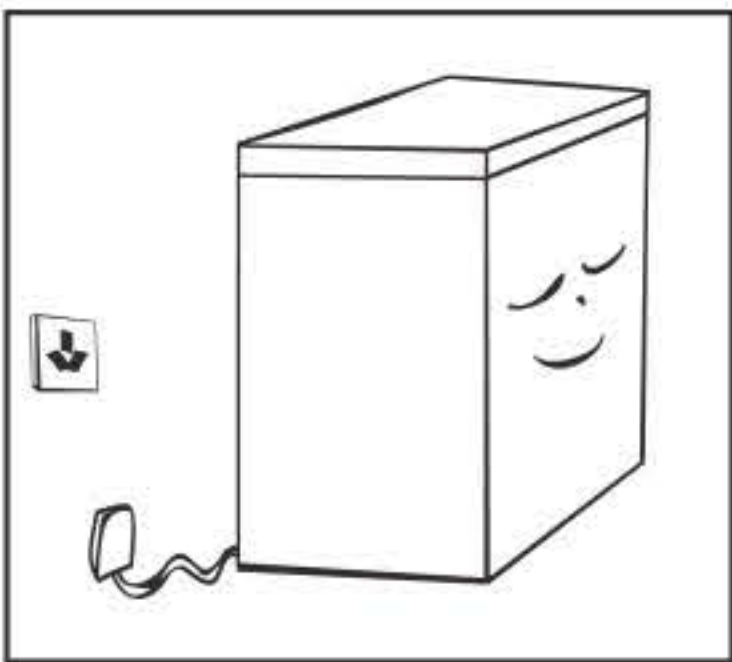

- The freezer shall stay for half an hour before connecting power when it is firstly started.
- The freezer shall run 2 to 3 hours before loading fresh or frozen foods; the freezer shall run for more than 4 hours in summer in advance considering that the ambient temperature is high.

2.5 Energy saving tips

- The appliance should be located in the coolest area of the room, away from heat producing appliances or heating ducts, and out of the direct sunlight.
- Let hot foods cool to room temperature before placing in the appliance. Overloading the appliance forces the compressor to run longer. Foods that freeze too slowly may lose quality, or spoil.
- Be sure to wrap foods properly, and wipe containers dry before placing them in the appliance. This cuts down on frost build-up inside the appliance.
- Appliance storage bin should not be lined with aluminum foil, wax paper, or paper toweling. Liners interfere with cold air circulation, making the appliance less efficient.
- Organize and label food to reduce door openings and extended searches. Remove as many items as needed at one time, and close the door as soon as possible.

3 Maintenance of freezer

3.1 Cleaning

- Dusts behind the freezer and on the ground shall be timely cleaned to improve the cooling effect and energy saving.
- Check the door gasket regularly to make sure there are no debris. Clean the door gasket with a soft cloth dampened with soapy water or diluted detergent.
- The interior of the freezer should be cleaned regularly to avoid odor.
- Please turn off the power before cleaning, remove all food, basket, container, etc.
- Use a soft cloth or sponge to clean the inside of the freezer, with two tablespoons of baking soda and a quart of warm water. Then rinse with water and wipe clean. After cleaning, open the door and let it dry naturally before turning on the power.
- For areas that are difficult to clean in the freezer (such as gaps or corners), it is recommended to wipe them regularly with a soft rag, soft brush, etc. and when necessary, combined with some auxiliary tools (such as thin sticks) to ensure no contaminants or bacteria accumulation in these areas.
- Do not use soap, detergent, scrub powder, spray cleaner, etc., as these may cause odors in the interior of the freezer or contaminated food.
- Clean the baskets with a soft cloth dampened with soapy water or diluted detergent. Dry with a soft cloth or dry naturally.
- Wipe the outer surface of the freezer with a soft cloth dampened with soapy water, detergent, etc., and then wipe dry.
- Do not use hard brushes, clean steel balls, wire brushes, abrasives (such as toothpastes), organic solvents (such as alcohol, acetone, banana oil, etc.), boiling water, acid or alkaline items, which may damage the freezer surface and interior. Boiling water and organic solvents such as benzene may deform or damage plastic parts.
- Do not rinse directly with water or other liquids during cleaning to avoid short circuits or affect electrical insulation after immersion.



⚠ Please unplug the freezer for defrost and cleaning.

3.2 Defrost

- Freezer shall be manually defrosted.
Unplug the freezer and open the freezer door, remove foods and shelving basket before defrosting; Open the outflow hole and drainage hole (and place water container at the outflow hole); indoor frost will naturally melt, wipe the defrost water with a dry, soft cloth. When the frost softens, an ice scraper might be used to the accelerate de-icing process.
- Please remove the food and put in a cool place when defrosting before removing accessories.

⚠ Other mechanical devices or other means shall not be used to accelerate except those recommended by the manufacturer. Do not damage the refrigerant circuit.

3.3 Stop using

- Power failure: Foods can be preserved for a couple of hours even in summer in case of power failure; it is recommended to reduce the frequency of opening door and do not put fresh foods into the freezer.
- Long-time nonuse: Please unplug the freezer left unused for a long time for cleaning. Keep the door open to avoid the bad odor.
- Moving: Do not turn upside or vibrate the freezer, the carrying angle can not be greater than 45°. Do not hold the door and hinge when moving this unit.

⚠ Continuous operation is recommended when the freezer is started. Please do not stop the freezer under normal circumstances so as not to affect the freezer's service life.

4 Trouble shooting

The following simple issues can be handled by the user. Please call the after-sale service department if the issues are not settled.

Inoperation	Whether the freezer is plugged and connected to power; Low voltage; Whether temperature control knob is in the work area; Failure power or tripping circuit.
Odor	Odorous foods should closely wrapped; Whether foods are rotten; Whether the interior shall be cleaned.
Long-term operation of compressor	It is normal that freezer operates for longer time in summer when the ambient temperature is higher; Do not put too much food in the freezer at one time; Do not put foods until they are cooled; Frequent opening of freezer door; Thick frost layer (defrost is needed).
Illuminating light does not shine	Whether the freezer is connected to power, whether the light is damaged.
The freezer door can not be properly closed	The freezer door is stuck by food packages; Too much food; Unbalanced freezer.
Loud noises	Whether the floor is flat, whether the placement of freezer is stable; Whether the freezer accessories are properly placed.
Transient difficulty in door opening	After refrigeration, there will be pressure difference between the inside and outside of the freezer to result in transient difficulty in door opening. This is a normal physical phenomenon.
Freezer enclosure heat Condensation	The freezer enclosure may emit heat during operation specially in summer, this is caused by the radiation of the condenser, and it is a normal phenomenon. Condensation: condensation phenomenon will be detected on the exterior surface and door seals of the freezer when the ambient humidity is large, this is a normal phenomenon, and the condensation can be wiped away with a dry towel.
Airflow sound Buzz Clatter	Refrigerants circulating in the refrigerant lines will produce eruption of sound and grunts which is normal does not affect the cooling effect. Buzz will be generated by running compressor specially when starting up or shutting down. The solenoid valve or electric switch valve will clatter which is a normal phenomenon and does not affect the operation.



make yourself at home