

cecotec

PURE AROMA 150 YIN

Aroma diffuser and humidifier with 150-ml tank.

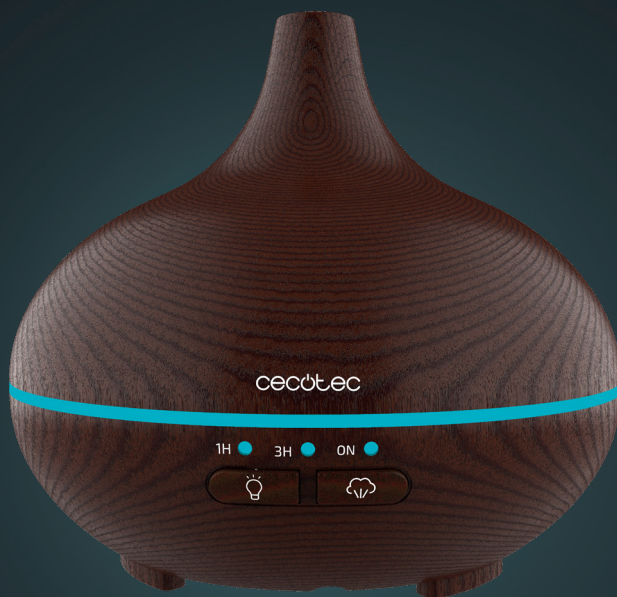

Instruction manual

INDEX

1. Parts and components
2. Before use
3. Operation
4. Cleaning and maintenance
5. Troubleshooting
6. Technical specifications
7. Disposal of old electrical appliances
8. Technical support and warranty

SAFETY INSTRUCTIONS

- Read these instructions thoroughly before using the appliance. Keep this instruction manual for future reference or new users.
- Do not twist, bend, strain, or damage the power cord in any way. Protect it from sharp edges and heat sources. Do not let it touch hot surfaces. Do not let the cord hang over the edge of the surface.
- Check the power cord regularly for visible damage. If the cord is damaged, it must be replaced by the official Technical Support Service of Cecotec in order to avoid any type of danger.
- Place the device on a flat, stable surface. Do not place it on carpets.
- Keep the device away from direct sunshine, heat sources, air conditioner or fans.
- The steam concentration may be affected by the type of water, humidity, temperature and wind direction.
- The product can only be used with 100 % natural essential

oil. Do not use oils containing chemicals, spices or impurities as these could cause product damage.

- Use tap or bottled water only.
- Do not move or cover the product while it is operating.
- Keep the product away from electrical appliances such as TVs or music equipment.
- Do not operate the product if it emits unusual smells or sounds.
- Do not allow steam to come into direct contact with furniture, clothing, walls or other obstacles.
- Do not try to disassemble or repair the product by yourself. Contact the official Technical Support Service of Cecotec.
- The appliance is not intended to be used by children under the age of 8. It can be used by children over the age of 8, as long as they are given continuous supervision.
- This product can be used by children and persons with reduced physical, sensory or mental capabilities or lack of experience and knowledge, as long as they have been given supervision or instruction concerning the use of the appliance in a safe way and understand the hazards involved.
- Supervise young children to make sure that they do not play with the appliance. Close supervision is necessary when the appliance is being used by or near children.

1. PARTS AND COMPONENTS

Fig. 1.

1. Steam outlet
2. Top cover
3. On/Off/Timer
4. Light
5. Base
6. Power socket
7. Water tank
8. Air inlet

2. BEFORE USE

- Take the product out of the box and remove all packaging materials.
- Make sure all parts and components are included and in good conditions. If any sign of visible damage is observed, contact immediately with our official Technical Support Service.

3. OPERATION

Fig. 2.

1. Place the product on a flat surface and remove the upper lid.
2. Connect the adapter to the product's socket.
3. Use a measuring cup to pour water inside the water tank. Then, add 2-3 drops of essential oil per each 100 ml.
4. Use the upper lid to close the unit again.
5. Connect the power adapter to a power supply.

Light button

1. Press the button once to turn on the product's light.
2. The colour will change from one to another automatically.
3. Press again to set the current colour steady.
4. Hold down the button to turn the light off.

On/Off/Timer button

1. Press the button to activate the mist. The yellow light will turn on.

2. Press the button again to select the timer: 1 h, 3 hrs, off.
3. Long press the button to turn the unit off.
4. If the product is knocked or tipped over:
5. Unplug the cord from the power supply.
6. Remove the upper lid and pour out the remaining water from inside.
7. Gently shake the unit and allow it to dry naturally for, at least, 24 hours. Fig. 3.

Note

If the device runs out or there is not enough water, the diffuser and its light indicators will automatically turn off.

Warnings

- Do not add water while the product is operating.
- Do not use water over 40 °C.

4. CLEANING AND MAINTENANCE

- After each 5-6 uses, follow the below steps to clean it:
- Unplug the product from the power supply and remove the upper lid.
- Pour out any remaining water through the emptying nozzle.
- Use a soft, damp cloth with some cleaning agent to clean the diffuser's outside.
- If the inside part is dirty, remove the inner cover to clean it.
- Do not use alcohol or abrasive detergents to clean the product as these could damage the surface.
- If the product is not going to be used for a long time, pour out the remaining water and store it in a safe place.

Warning

Do not pour the remaining water through the air inlet or any other part. Water can only be poured through the water outlet in order to avoid product damage. Fig. 4.

5. TROUBLESHOOTING

Problem	Cause	Solution
The unit does not turn on or off.	There is not enough water in the tank.	Add water to tank.
	The power cord is not properly plugged.	Disconnect the power cord, check the cord and connect it again.

The product emits unusual or no steam.	Not enough or too much water in the tank.	Add the correct amount of water (do not exceed the max. mark).
	The water tank is dirty.	Follow the "Cleaning and maintenance" steps.
	The air inlet or the product's base is dirty.	Clean both the air inlet and the product's base in order to remove blockages.
Water leaks.	The upper lid and the inner cover are not fixed properly.	Remove the upper lid and the inner cover so mist can be released and installed them back in their correct position.
	Temperature is too low or there is too much humidity and steam condenses, forming water droplets.	Do not operate the product under humid or extremely cold conditions.

6. TECHNICAL SPECIFICATIONS

Model: Pure Aroma 150 Yin

Product reference: 05285

Power: 15,6 W, 100-240 V, 50/60 Hz

Made in China | Designed in Spain

7. DISPOSAL OF OLD ELECTRICAL APPLIANCES



The European directive 2012/19/EU on Waste Electrical and Electronic Equipment (WEEE), specifies that old household electrical appliances must not be disposed of with the normal unsorted municipal waste. Old appliances must be collected separately, in order to optimise the recovery and recycling of the materials they contain and reduce the impact on human health and the environment.

The crossed out "wheeled bin" symbol on the product reminds you of your obligation to dispose of the appliance correctly.

Consumers must contact their local authorities or retailer for information concerning the correct disposal of old appliances and/or their batteries.

8. TECHNICAL SUPPORT AND WARRANTY

This product is under warranty for 2 years from the date of purchase, as long as the proof of purchase is submitted, the product is in perfect physical condition, and it has been given proper use, as explained in this instruction manual.

The warranty will not cover the following situations:

The product has been used for purposes other than those intended for it, misused, beaten, exposed to moisture, immersed in liquid or corrosive substances, as well as any other fault attributable to the customer.

The product has been disassembled, modified, or repaired by persons, not authorised by the official Technical Support Service of Cecotec.

Faults deriving from the normal wear and tear of its parts, due to use.

The warranty service covers every manufacturing defects of your appliance for 2 years, based on current legislation, except consumable parts. In the event of misuse, the warranty will not apply.

If at any moment you detect any problem with your product or have any doubt, do not hesitate to contact Cecotec Technical Support Service at +34 963 210 728.

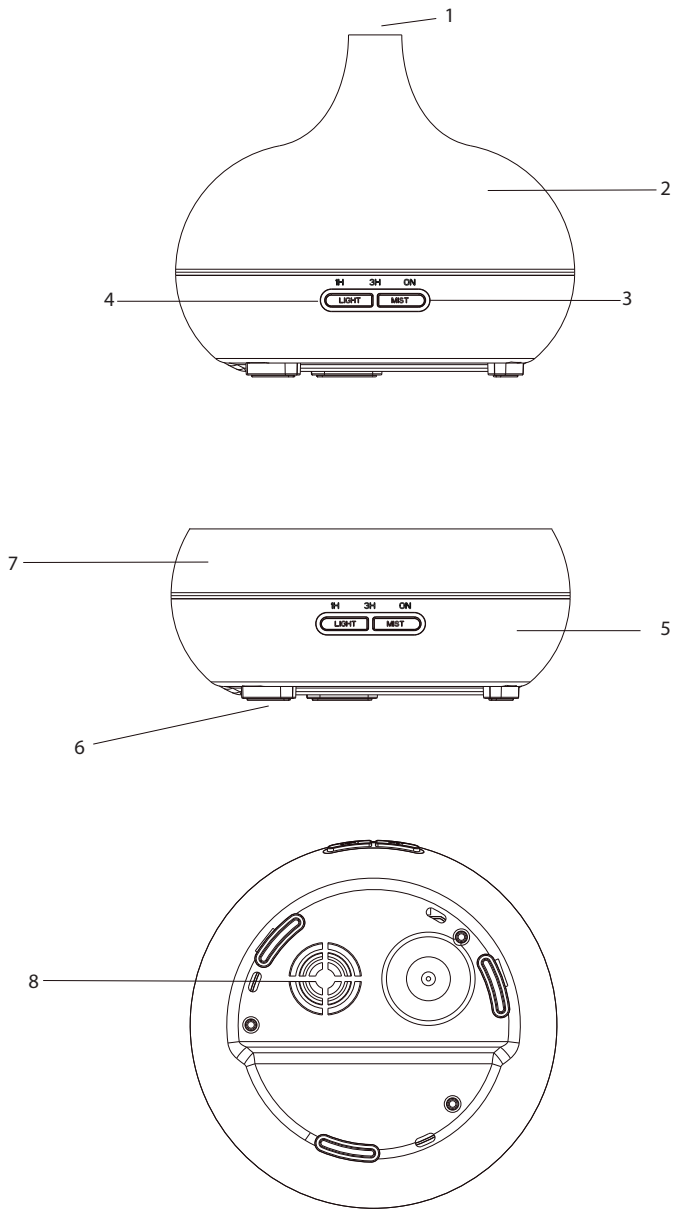

Fig./Img./Abb./Afb./ Rys./Obr. 1



Fig./Img./Abb./Afb./
Rys./Obr. 2

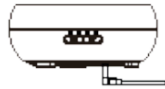

Fig./Img./Abb./Afb./
Rys./Obr. 3

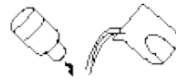

Fig./Img./Abb./Afb./
Rys./Obr. 4

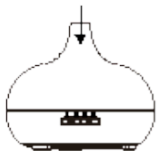

Fig./Img./Abb./Afb./
Rys./Obr. 5

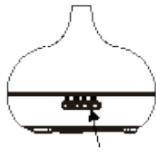

Fig./Img./Abb./Afb./
Rys./Obr. 6

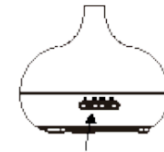

Fig./Img./Abb./Afb./
Rys./Obr. 7

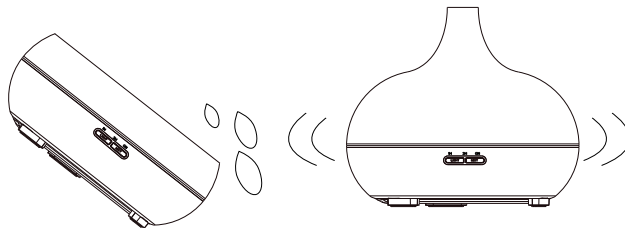

Fig./Img./Abb./Afb./ Rys./Obr. 8

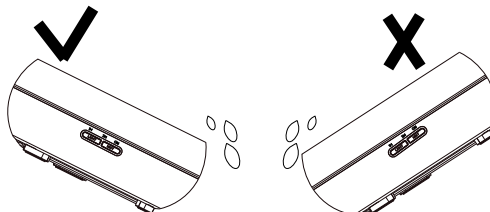

Fig./Img./Abb./Afb./ Rys./Obr. 9

www.cecotec.es

Cecotec Innovaciones S. L.
C/de la Pinadeta s/n, 46930
Quart de Poblet, Valencia, Spain

EA02210511