

SOFA BED

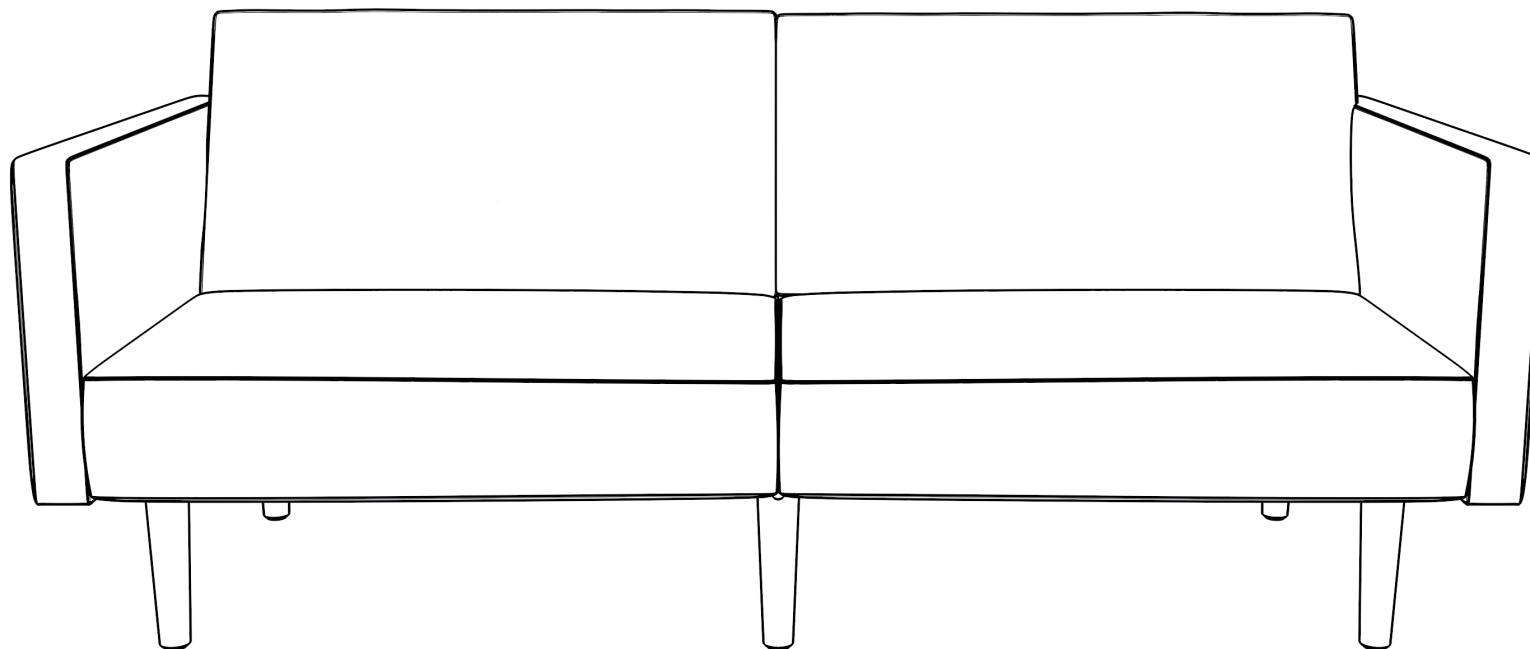

THIS INSTRUCTION BOOKLET CONTAINS **IMPORTANT** SAFETY INFORMATION. PLEASE READ AND KEEP FOR FUTURE REFERENCE.

Warranty Information

We warrant this product to be free from defects in material and workmanship and agrees to remedy any such defect. This warranty covers one year from the date of original purchase. This is solely limited to the repair or replacement of defective parts and assembly labor is not included.

This warranty does not apply to any product which has been improperly assembled, subjected to misuse or abuse or which has been altered or repaired in any way. Liability for consequential damages is excluded to the extent exclusion is permitted by law. This warranty gives you specific legal rights and you may also have other rights which vary from state to state.

To obtain warranty service, purchaser must present original bill of sale. Components repaired or replaced are warranted through the remainder of the original warranty period only. The defective components will be repaired or replaced without charge, subject to the terms and conditions described above.

Caution

- This product is designed for home use and not intended for commercial use.
- This product contains small components. Please ensure that they are kept away from small children.
- Do not use power tools to assemble your furniture. Power tools may strip or damage the parts.



Read Before Beginning Assembly

- Call our toll free number if you need assistance.
- Work in a spacious area and near where the unit will be used, preferably on a carpet, or use a piece of the cardboard packaging to protect your floor and product.
- Recommended # of people needed for assembly: **2** (however it is always better to have an extra hand). Estimated assembly time is **30 min**.
- Make sure all parts are included. Most parts are labeled or stamped on the raw edge.
- Read each step carefully. It is very important that each step of the instructions is performed in the correct order. If these steps are not followed in sequence, assembly difficulties will occur.

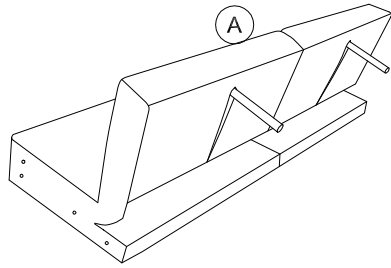

☐
Seat
X 1

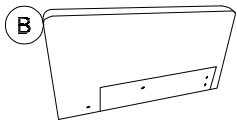

☐
Armrest
X 1

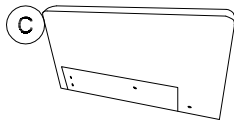

☐
Armrest
X 1

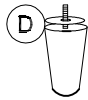

☐
Leg
X 4



☐
Middle Leg
X 2

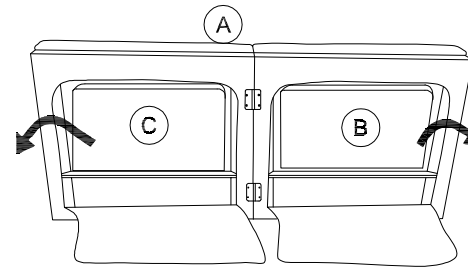

Parts

- ⚠ All in 1 big box!
- ⚠ There are inner box(es) that include components required to complete this assembly.
- ☑ Before you throw the package, please use the Check Box to identify the parts and ensure that you have all the parts needed for the assembly.

⚠ Some parts will be found in the compartment under the seat as shown.

Hardware Pack

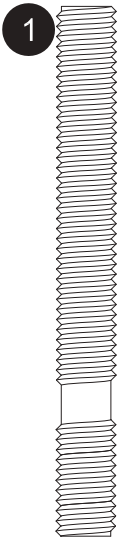

1

X 8

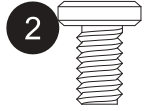

2

M6 X 10mm
X 8



3

Allen Key 4mm
X 1

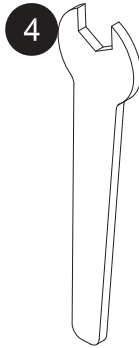

4

Wrench
X 1

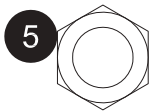

5

Nut
X 8



6

Spring Washer
X 8



Please do not completely tighten all the hardware, until the entire assembly is complete, unless otherwise indicated in the step-by-step instructions.



The screw(s), bolt(s) to be used at each step are shown in actual size in the lower right corner of the page.

Step 1

Finger tighten **1** to **C**, as shown.

Then repeat the same procedure for **B**.

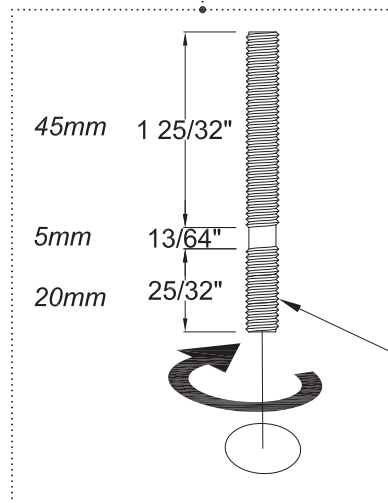
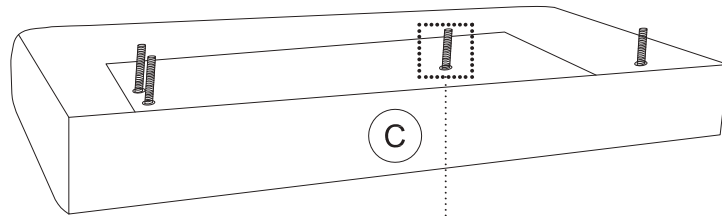

Note: Only screw in the shortest threaded part of the Bolts.

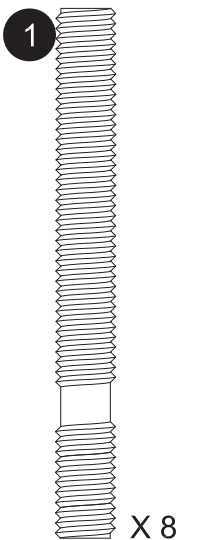

Step 2

Attach **B** & **C** to **A** with **5**, **6**,
as shown.

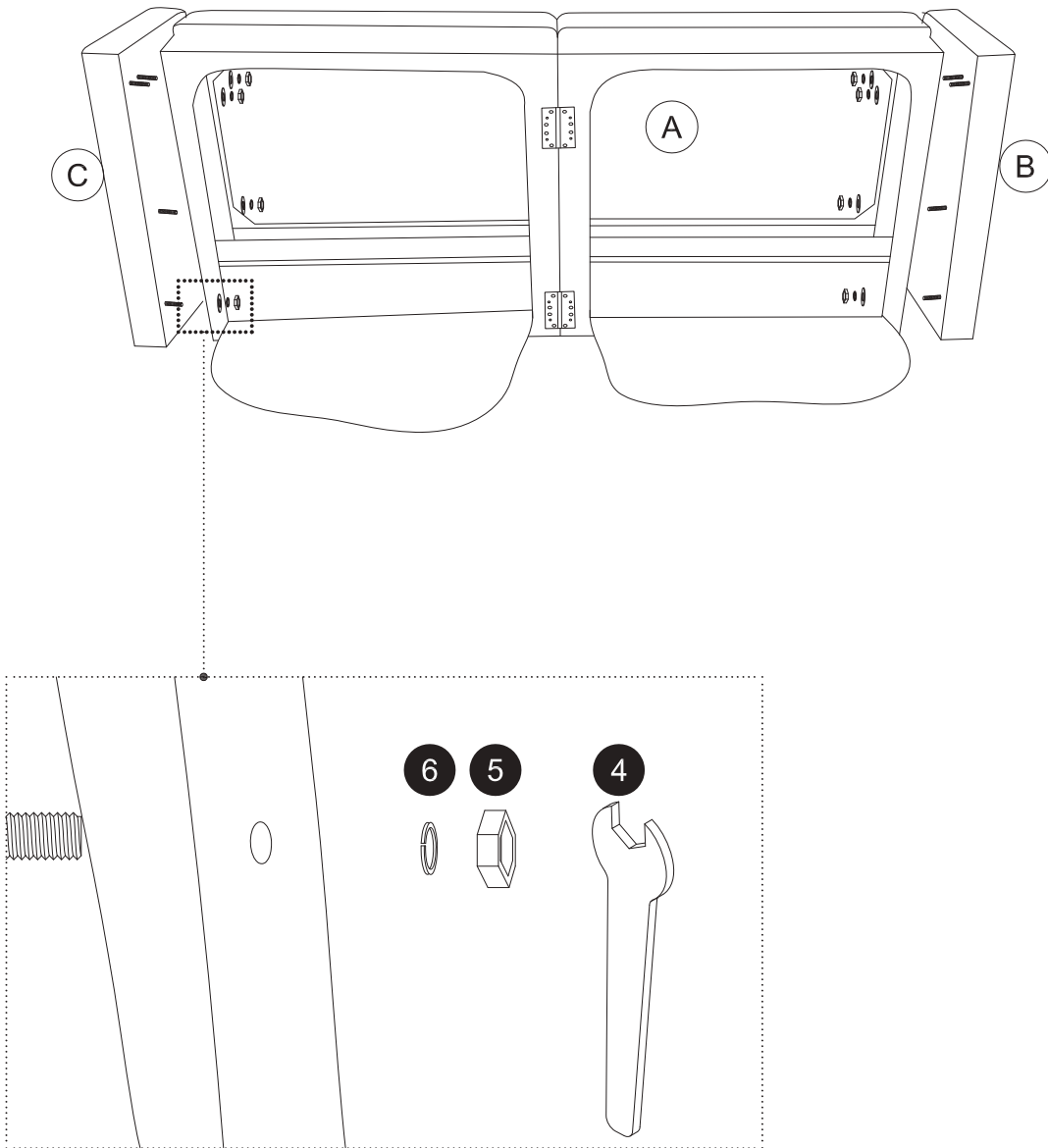

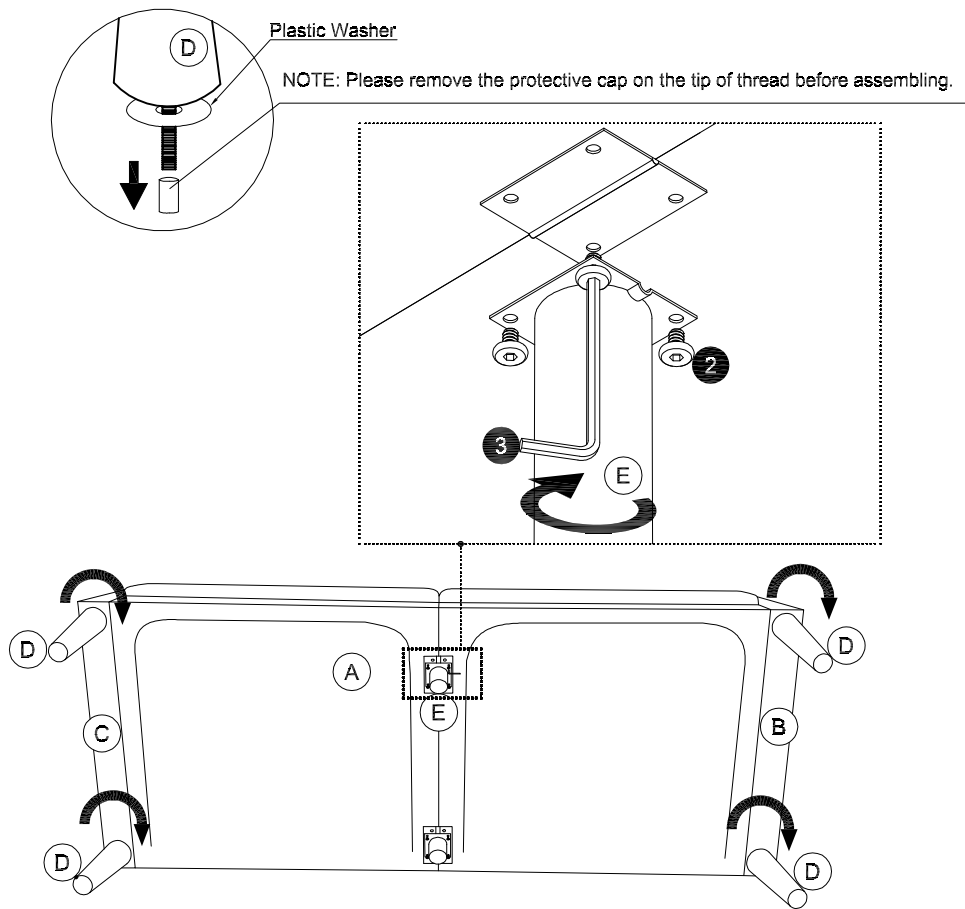

Step 3

Attach D to B & C .

Attach E to A with 2 , as shown .

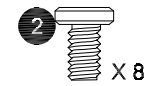

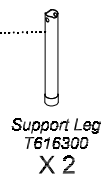
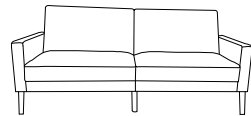
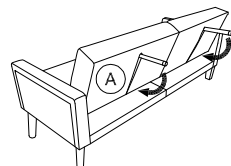
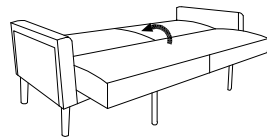
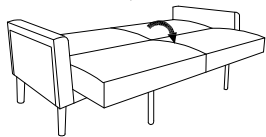
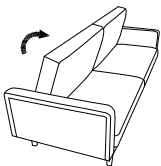
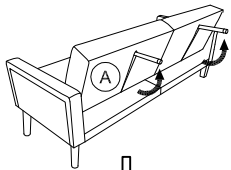
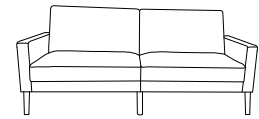

Helpful Hints

- Move your new furniture carefully, with two people lifting and carrying the unit to its new location.
- Clean the product with a soft damp cloth. DO NOT use harsh chemicals or abrasive cleaners.
- Some parts have been pre-assembled for this item. They are illustrated on this page and available for replacement.