

WATER BOTTLE FILTRATION SYSTEM **Instruction Manual**

Before installing and operating your water purifier, please read the instruction manual carefully and keep it for future reference.

1. Technical Parameters

Model	QU1646-25L
Dimension	Assembly size: 322*289*505mm; carton size: 302*302*300mm
Capacity of upper barrel	9L
Capacity of lower barrel	16L
Filter	PP cotton + active carbon + ultra-filtration
Service life of filter	6~12 months (the replacement cycle is subject to the local water quality)
Applicable water temperature	4~38°C
Filtering capacity	Active Carbon: reduce the chlorine and absorb organic contaminants
	UF Membrane: reduce sediment, suspended Solid, bacteria
Working range	For using cold municipal water supply only

2. Assembly Drawing

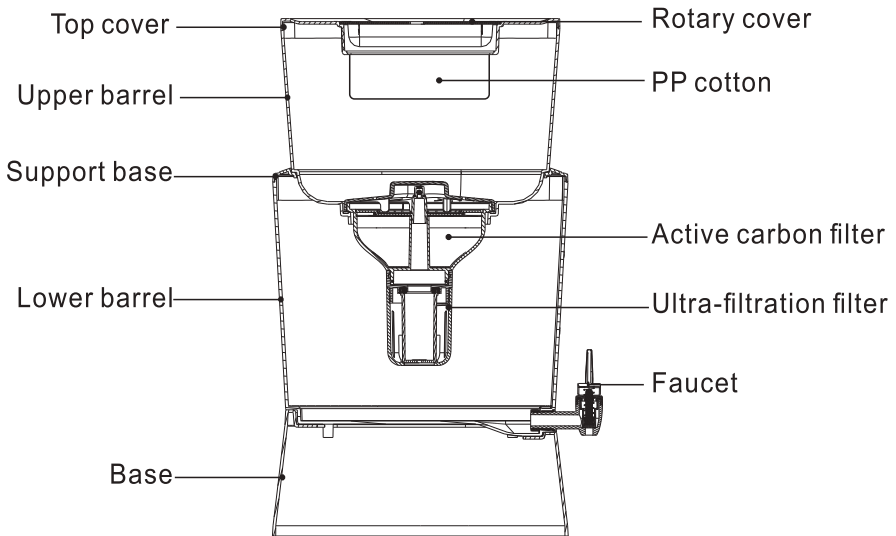

3. Explosive View

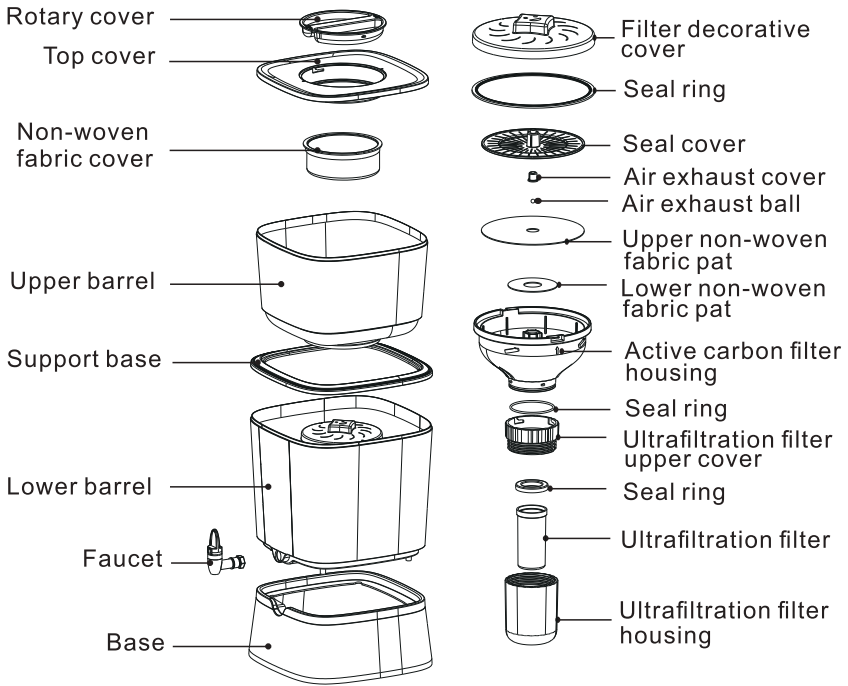

4. Install and Flush the filter

4.1 Install the active carbon filter

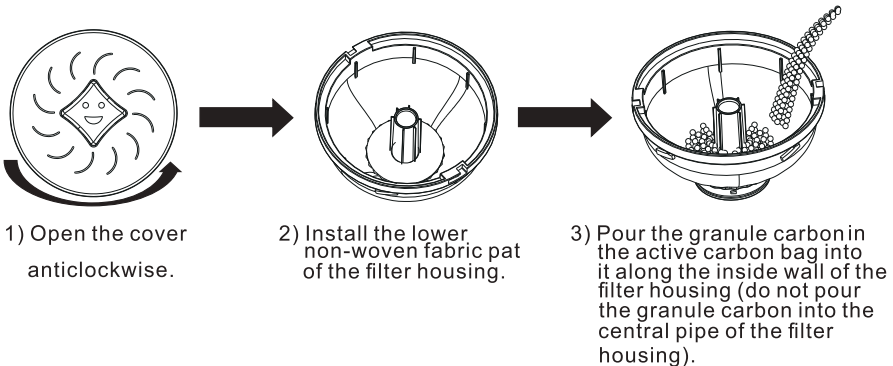

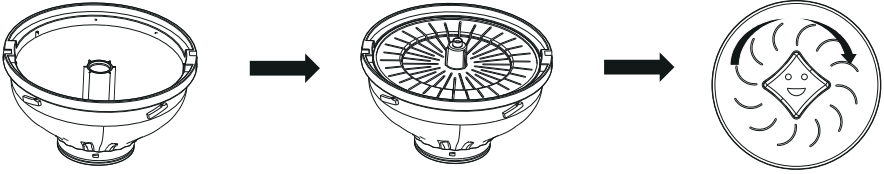

- 4) Install the upper non-woven fabric pat of the filter housing. 5) Install the upper top cover. 6) Aim at the clamp position, turn the cover clockwise till it makes "tick" sound, which means it has taken in place.

4.2 Flush the active carbon filter

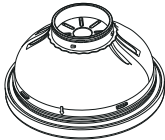

- 1) Install the seal ring in the seal ring



- 2) Press the filter cover in the upper barrel

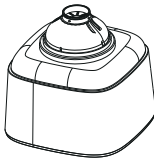

- 3) Turn over and check the filter in the upper barrel



- 4) Put it on the lower barrel, flush it with tap water for about 5min till it doesn't output black water (adding the water pouring icon for the upper barrel in the picture)

4.3 Installation of ultra-filtration filter



- 1) Install the seal ring on the active carbon filter.

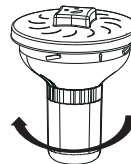

- 2) Install at the bottom of the active carbon filter, aim at the clamping position, and tighten it clockwise.

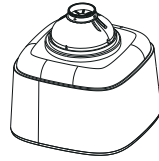
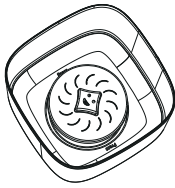

3) Press the filter cover in the upper barrel

4) Turn over and check the filter in the upper barrel

5. Install the Faucet

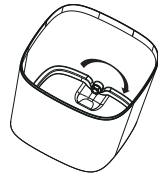
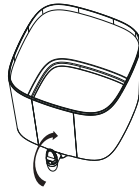

1) Insert the faucet into the lower barrel.

2) Turn it clockwise till taking place.

3) Rotate till the faucet keeps in the middle.

4) Tighten the nut clockwise.

6. Install the Whole Unit

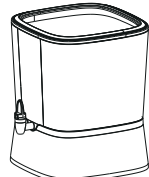

1) Put the base.

2) Put the lower barrel with faucet on the base.

3) Put the support base on the upper barrel.

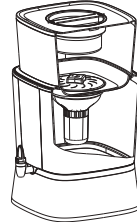
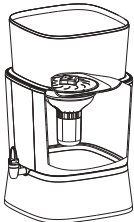

4) Put the upper barrel with filter on the support base.

5) Install the top cover.

6) Install the non-woven fabric and rotary cover.

7. Use Instructions

- 1) The filter must be thoroughly flushed before using the active carbon filter for the first time, refer to 4.2 for the method.
- 2) Open the rotary cover, pour tap water into it, shown as drawing below.



- 3) Please do not feed too much tap water since the filtering speed is slow, stop feeding water if the upper barrel is full of water.



- 4) It is suggested to feed water for filtering when the water level of the lower barrel is lower than the mark, thus avoiding the risk that the filtered water overflows the base.



8. Maintenance of Filter

S/N	Filter	Replacement Cycle	Filter Maintenance
1	PP cotton	6~12 months	When the PP cotton surface is dirt, please remove and clean the PP cotton cover. It is suggested to flush it from the rear side under the faucet; it shall be cleaned at least once a month.
2	Active carbon	6~12 months	It must be flushed with water for over 5min before using it for the first time, install the ultra-filtration filter after it doesn't output black water.
3	Ultra-filtration	6~12 months	When the ultra-filtration filter outputs water at a lot flow rate (<60ml/min), please remove and clean the ultra-filtration filter. It is suggested to flush it under the faucet, carefully swing it when flushing, and avoid flushing it with rapid water. It shall be cleaned at least once a month.

Note: The replacement cycle is subject to the local water quality (10L a day for most families)

9. Replace the filter

- 1) Open the upper cover of the active carbon filter, take out the active carbon, flush the filter housing, then add active carbon according to Step 2.1;
- 2) Open the ultrafiltration filter, take out the ultrafiltration, replace it with a new ultrafiltration, the method is shown as below:

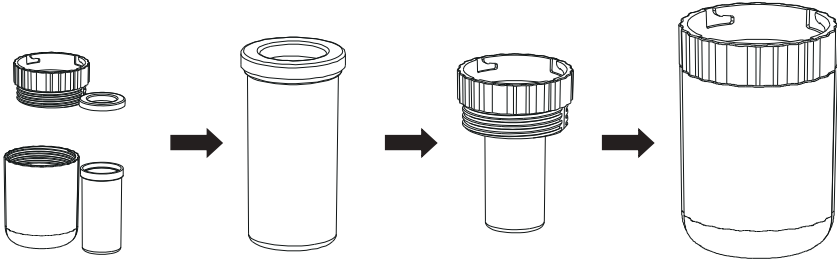

1) Filter housing, seal ring and filter.

2) Fix the seal ring on the filter.

3) Insert the filter and seal ring into the upper housing.

4) Rotate and align the upper and lower housing.

10. Cautions

- 1) Please store the water purifier barrel in shady place without direct sunlight and far from heat source.
- 2) If the water purifier barrel won't be used for a long period (such as enjoying holiday), it is suggested to discharge water from the water purifier barrel.
- 3) If the water purifier barrel has contacted the foods which may possibly cause color changing, such as tomato, please clean it as soon as possible.
- 4) The seal ring is applied with food class sealing oil before delivery, please use it with heart relaxed.
- 5) Since the water quality in different areas is different, please cleanse the upper and lower water barrels once a month.
- 6) Please put the product on the even place, and avoid putting it on the inclined desk.

The product is subject to change without notice.
Please keep this manual properly.