

TPGR-30

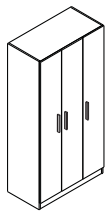

**TWO PERSON
ASSEMBLY
REQUIRED!**



Rev. 00
30.04.2018

**EN AZ İKİ KİŞİ
İLE KURUNUZ!**

TR
Garanti şartlarının geçerli olması için kurulum şemasındaki sıraya uygun olarak montaj yapılması gerekmektedir.
Hatasız ve daha kolay montaj için tüm parçaları önce geniş ve düz zemine diziniz.
Şemada gösterilen parça listesi ile ürün kutusundan çıkan parçaları karşılaştırınız.
Montajı ürün kolisi üzerinde veya sert ve çizici olmayan bir zeminde, parça kutusundan çıkan «L» şeklindeki alyan anahtar ile yapınız.
Montajla ilgili sorularınız ve istekleriniz için, Lütfen önce ürünü satın aldığınız yetkili satıcımıza danışınız.
Kurulum şemasını ve garanti belgesini, ödeme evraklarınızla saklayınız.

EN
Please read the instruction sheets completely.
Remove all parts from carton box and ensure all parts are included.
Remove all parts from the carton box and check that all parts are included.
Assemble the product on the carton box or carpet to prevent scratching or damage.
Make assembly with the «L» shaped allen key that you will find in the tool bag.

GR
Παρακαλούμε διαβάστε προσεκτικά τα φύλλα οδηγιών.
Αφαιρέστε όλα τα κομμάτια από το κουτί και βεβαιωθείτε ότι όλα συμπεριλαμβάνονται.
Αφαιρέστε όλα τα κομμάτια από το κουτί και ελέγξτε ότι όλα συμπεριλαμβάνονται.
Συναρμολογήστε το προϊόν πάνω στο κουτί ή σε χαλί, για να αποφύγετε τυχόν γρατζουνιές ή φθορές του προϊόντος.
Η συναρμολόγηση γίνεται με το κλειδί allen που θα βρείτε μέσα στο σακουλάκι με τα εργαλεία και τις βίδες.

RO
Vă rugăm să citiți instrucțiunile, în totalitate.
Scoateți toate piesele din cutia de carton și asigurați/vă că toate piesele sunt incluse.
Scoateți toate piesele din cutia de carton și controlați dacă toate piesele sunt incluse.
Asamblați produsul pe cutia de carton sau pe un covor, pentru a preveni scrijelirea sau deteriorarea.
Realizați asamblarea cu cheia imbus în formă de L pe care o găsiți în trusa de scule.

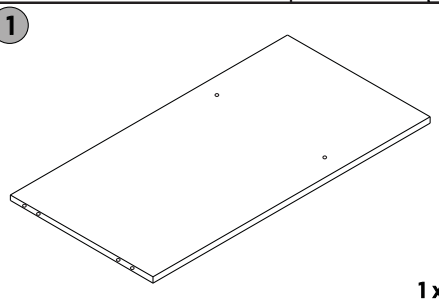

1x

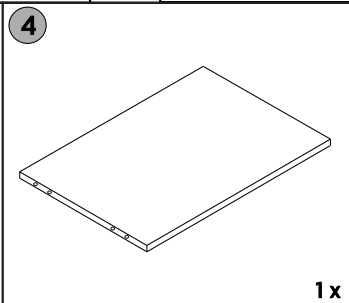

1x

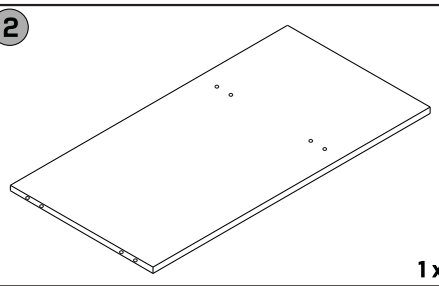

1x

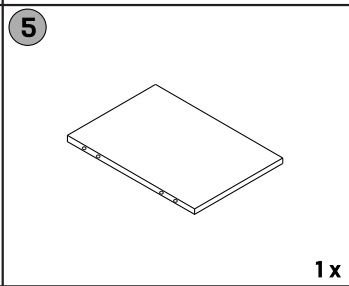

1x

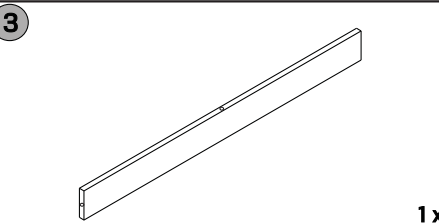

1x

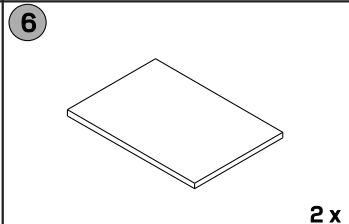

2x

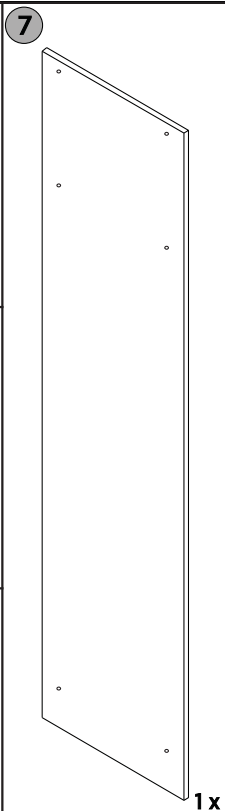

1x

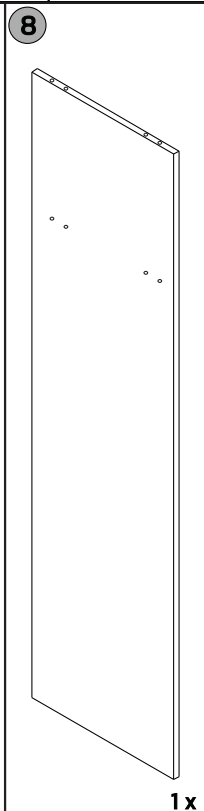

1x

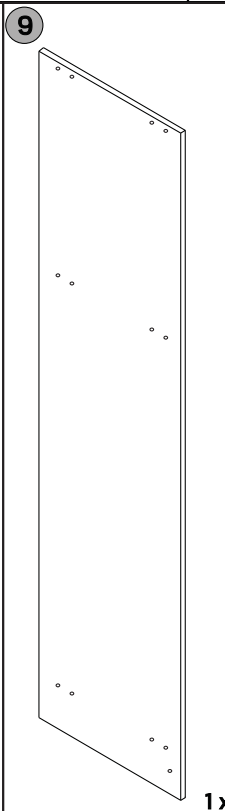

1x

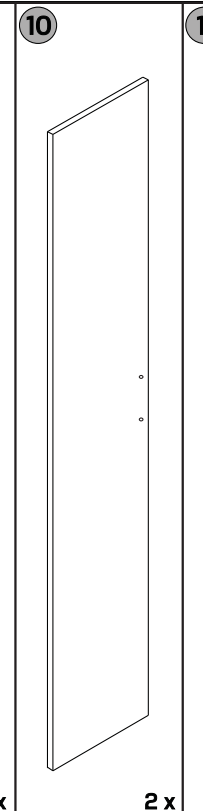

2x

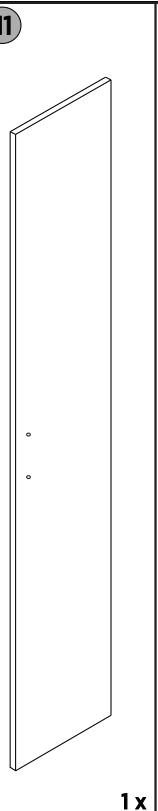

1x

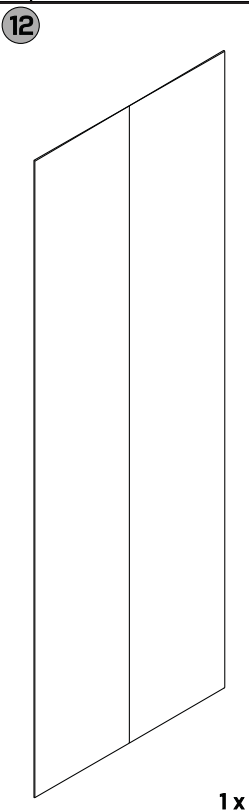

1x

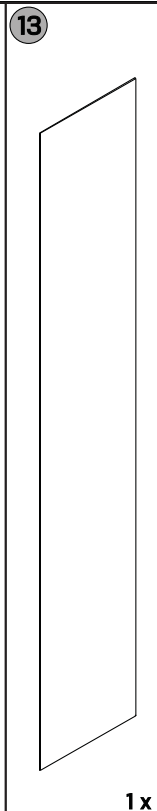

1x

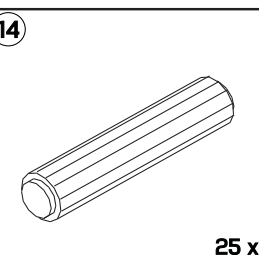

25 x

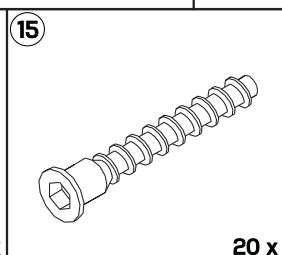

20 x

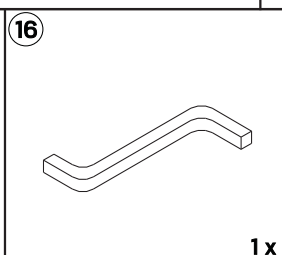

1 x

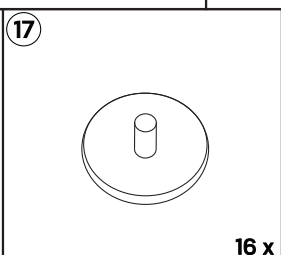

16 x

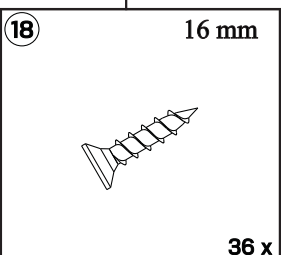

16 mm

36 x

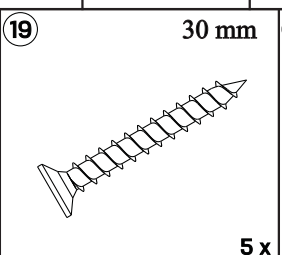

30 mm

5 x

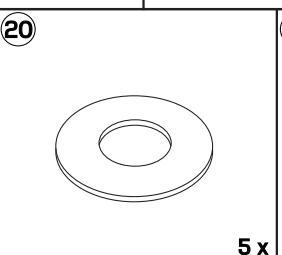

5 x

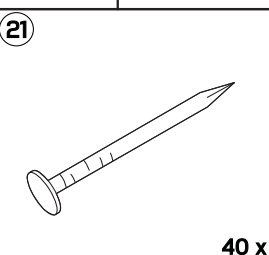

40 x

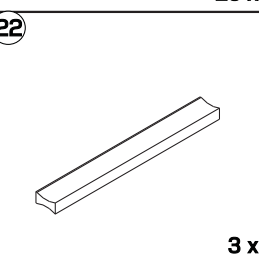

3 x

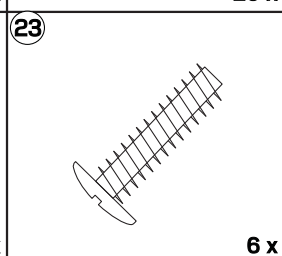

6 x

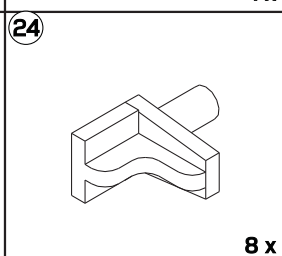

8 x

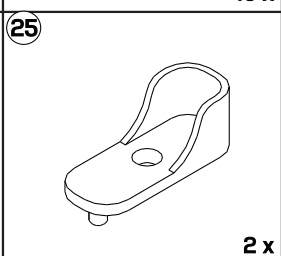

2 x

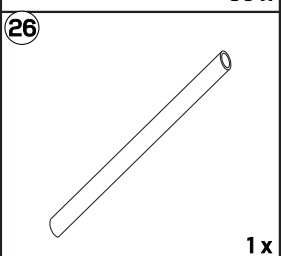

1 x

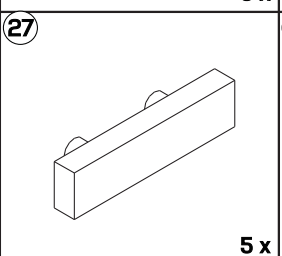

5 x

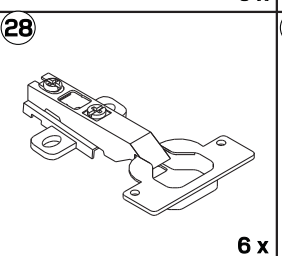

6 x

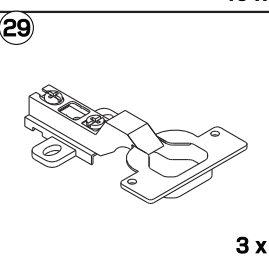

3 x

1

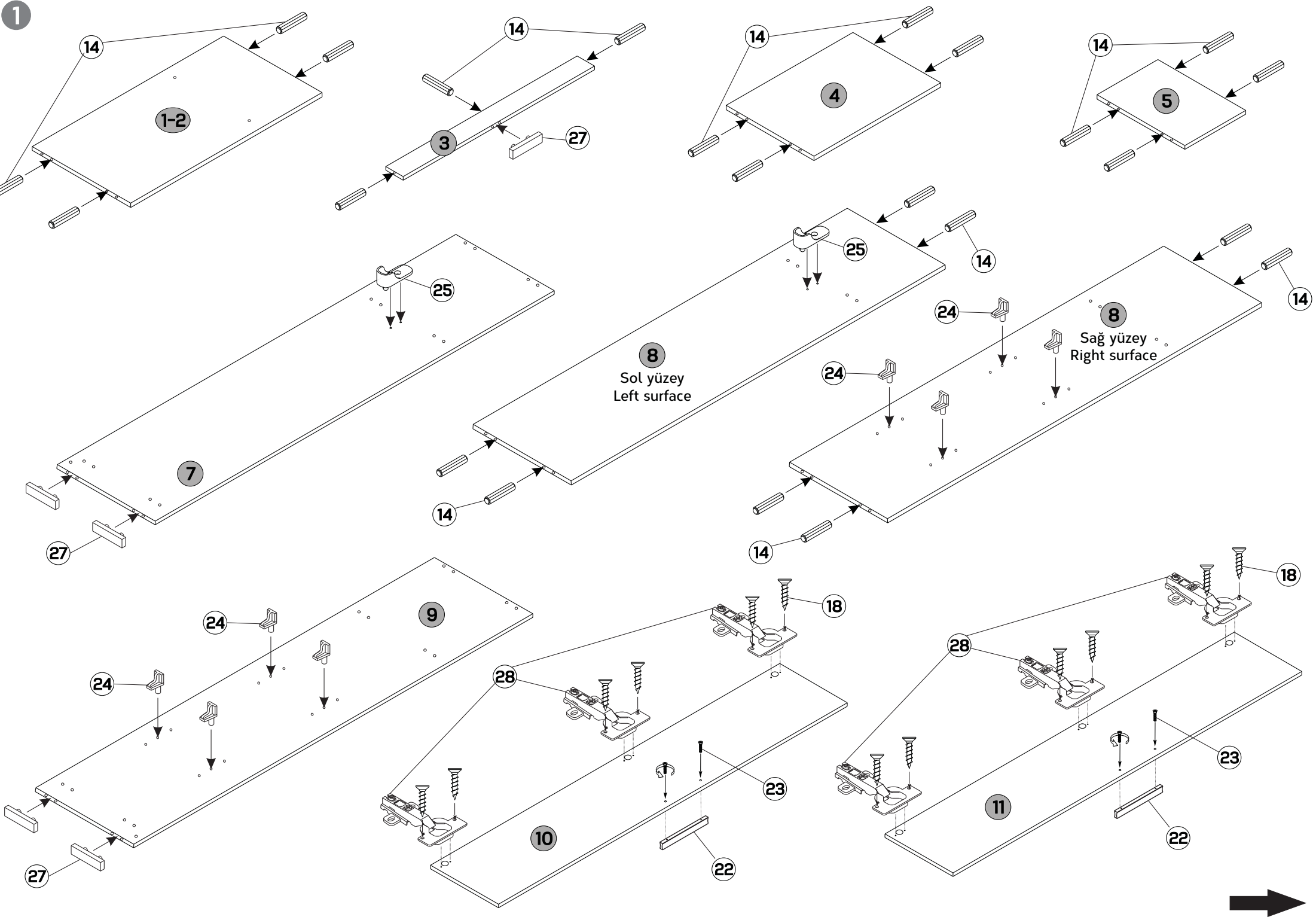

2

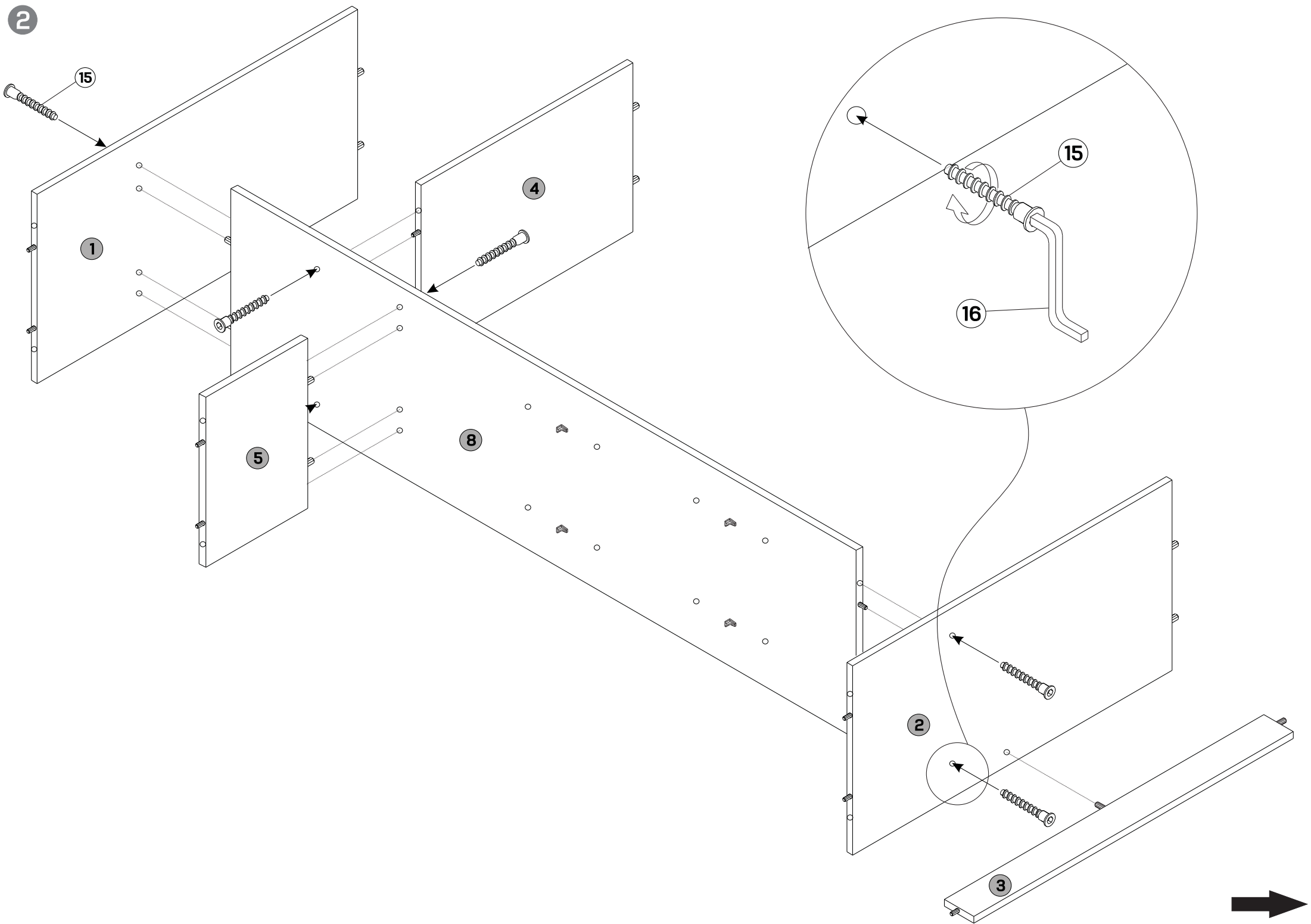

15

1

4

5

8

15

16

2

3



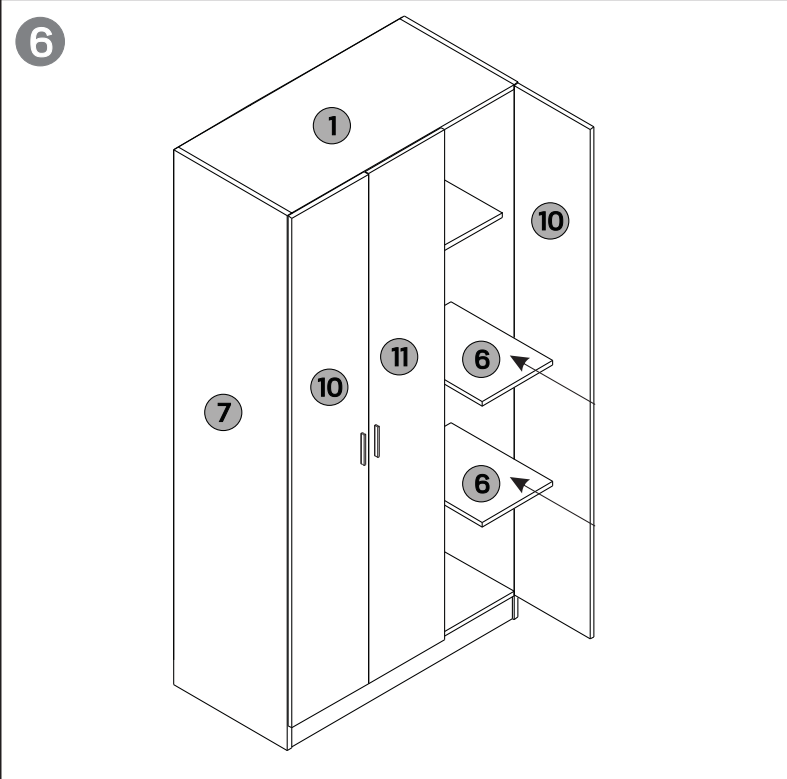
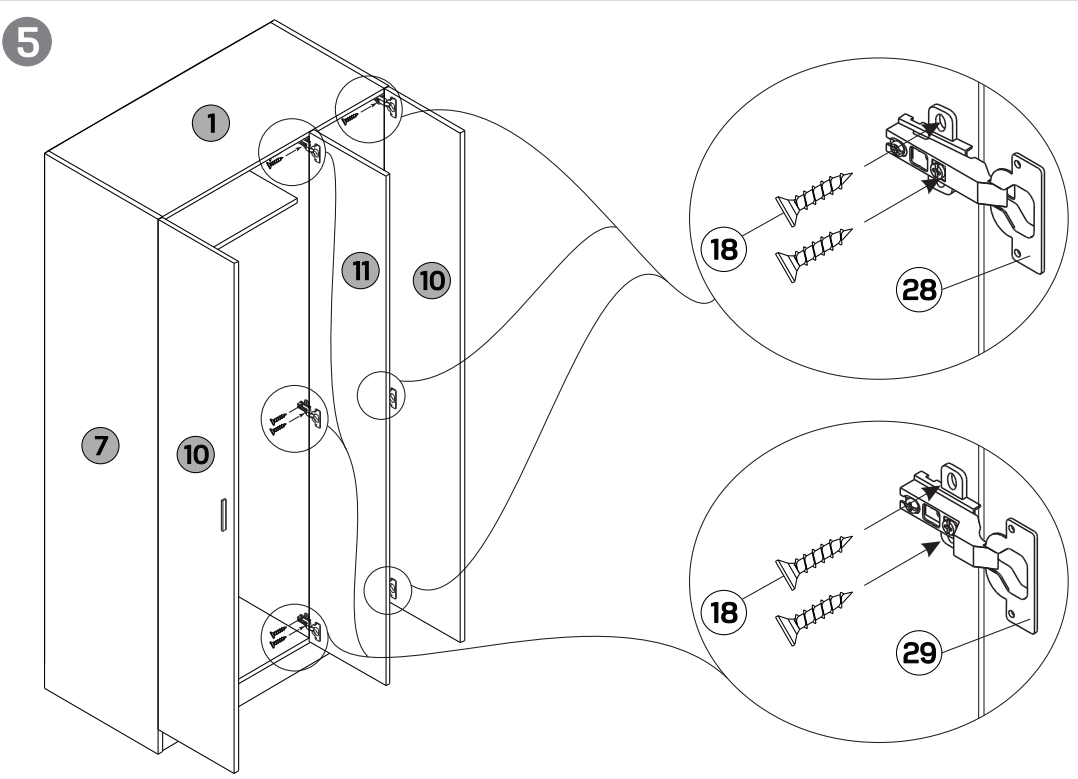
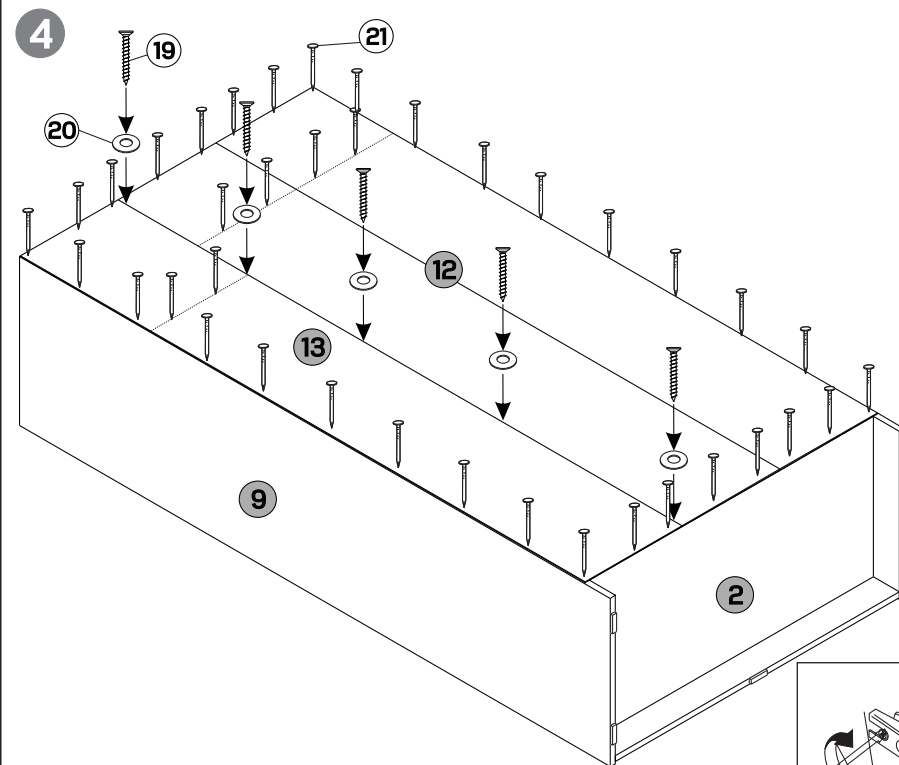
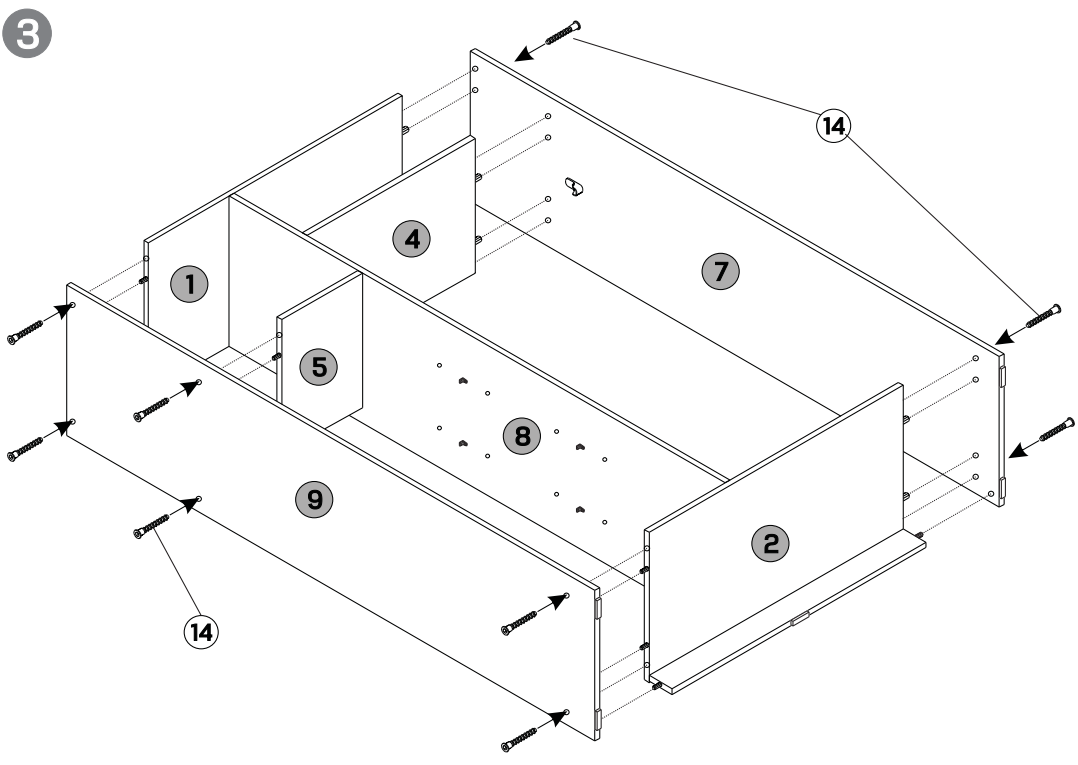

<p>Kapak İleri-Geri Forward-backwards Înainte-Înapoi Μπροσ-πίσω</p>	Reglarea capacului	Ρύθμιση πορτας
<p>Kapak Sağ-sol Right-left Stânga-dreapta Δεξιά-Αριστερά</p>	KAPAK AYARI	DOOR ADJUSTMENT
<p>Kapak Yukarı-Aşağı Upwards-downwards sus-jos Προς τα πάνω- προς τα κάτω</p>		