



TO GO INFRASTRUCTURES INC.
 927 GAUDETTE STREET
 SAINT-JEAN-SUR-RICHELIEU, QUÉBEC
 J3B 7S7 Canada

PHONE (01) 450.359.4000
TOLL FREE 1 844.2GO.2014
FAX (01) 450.359.4242

INFO@TOGOCORP.COM

HEAVY DUTY PREMIUM ALUMINUM DECK WITH HEXAGRIP FINISH 2'x6'

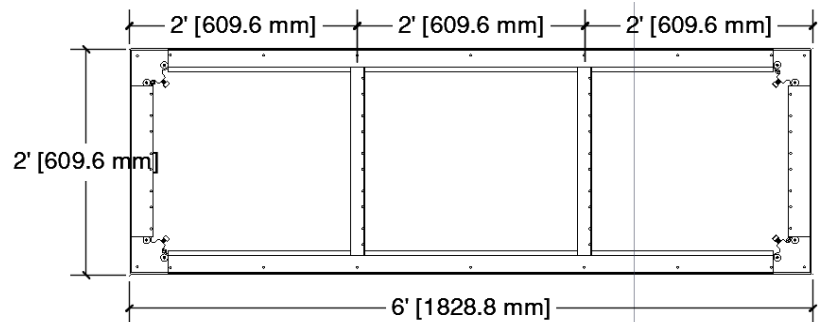
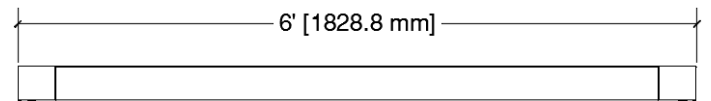
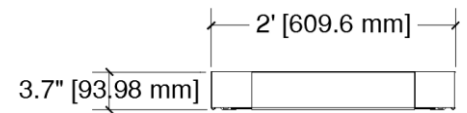
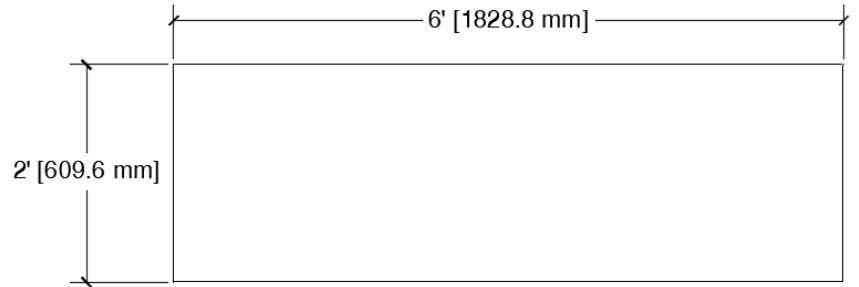

SKU	842315002573
Dimensions	2' x 6' x 3.7" 609.6mm x 1828.8mm x 93.98mm
Weight	62.5 lbs - 28.35 kg
Load Capacity	200 lbs/sq.ft.
Material	Aluminium 6063 Hexagrip Plywood (outdoor grade)
Leveling	Threaded hole in each corner 3/8-16 or M10
Tool(s) needed	5/16" Allen key
Color/paint	Natural Mill Finish
Link to website	(Click here)
Description	The heavy duty premium deck series offers ratings from 100 lb/sqft to 300 lb/sqft. This is the ultimate product for stages, tiered seatings, heavy duty event floorings and rolling risers. The premium aluminium deck will not rust. This deck is very versatile, durable, safe and cost effective. Available in different sizes. This product utilizes our patented Union Clips. Roto locks are no longer needed. If you are looking for a cheaper solution, see our SB44LC deck module.