



How to fit your 50mm diameter curtain pole

Please note: the screws and wall plugs supplied are only suitable for solid walls.

You will need

- pencil
- tape measure
- spirit level
- appropriate wall plugs and screws
- drill and bits
- hand saw or mitre saw (if you wish to cut your pole to size)

Bracket Placement

Brackets should be placed approximately 10cm in from the end of the pole.

1. The recommended maximum span between brackets is 200cm for wooden poles and brushed bronze poles and 240cm for stainless steel poles (as shown in illustration 1 below). This may vary depending on the weight of your curtains.
2. If the pole is in one piece (i.e. shorter than 240cm) then the same bracket is used in the centre as at the ends.
3. If the pole is wood and in two pieces (i.e. over 240cm), then a 'connector bracket' must be used to join the two spigot ended poles.
4. If the pole is stainless steel or brushed bronze and in two pieces (i.e. over 240cm), then a ring bracket is used to join the poles together.



Joining Two Poles

Wood & Acrylic Poles



1. Loosen the two grub screws on the ring of the connector bracket.

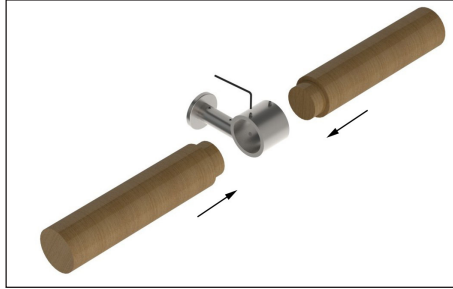

2. Place the spigot end of each pole inside the connector bracket.

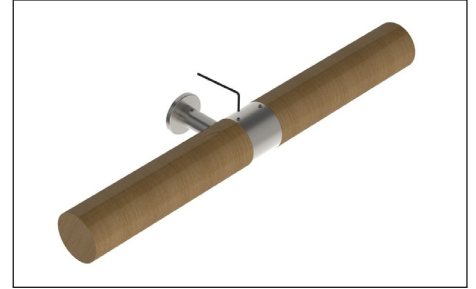

3. Tighten the grub screws so the poles are held tightly in position.

Stainless Steel / Brushed Bronze Poles

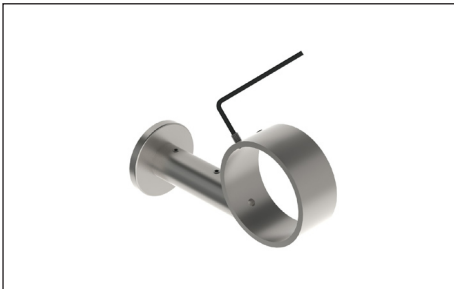

1. Loosen the two grub screws on the ring of the bracket.

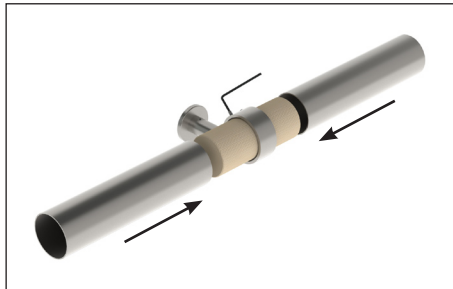

2. Place the end of each pole equally into the ring bracket, using the wooden dowel to strengthen the join.

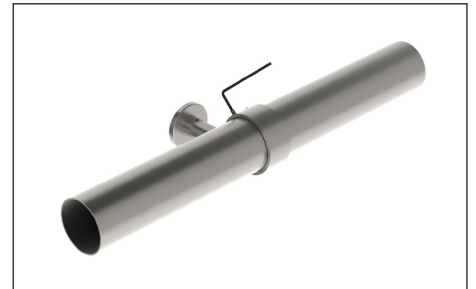

3. Tighten the grub screws so the poles are held tightly in position.

Fitting Wall Plates

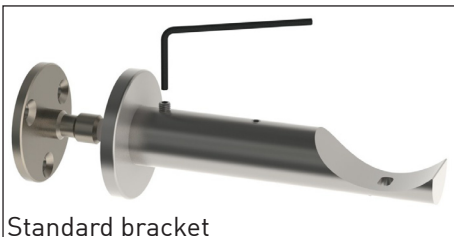

Standard bracket

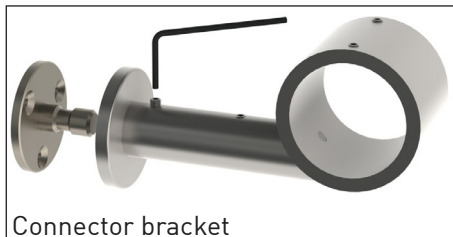

Connector bracket

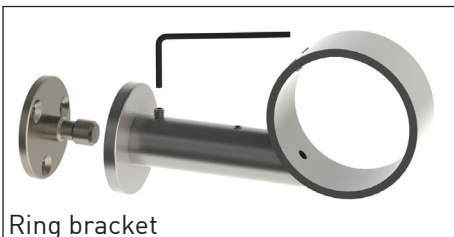

Ring bracket

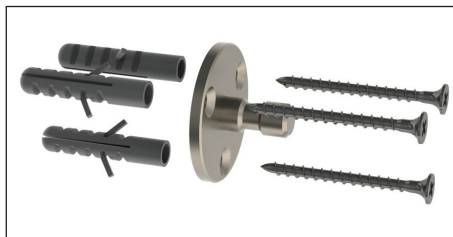

1. Remove the wall plate from the bracket by loosening the grub screw(s) with the supplied allen key.
2. Position the wall plate against the wall and mark the positions of the holes. For best support locate two screws at the top.
3. If mounting onto a wooden batten, drill a 2mm pilot hole, or, if mounting directly onto a masonry wall, use the appropriate drill size and insert suitable wall plugs.

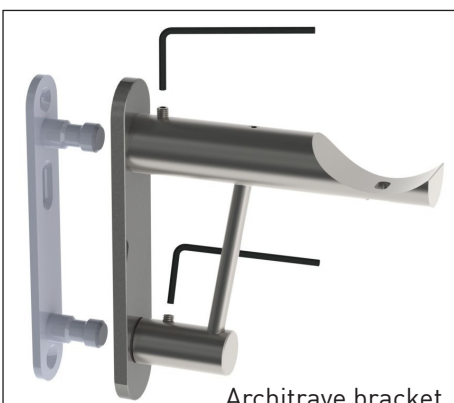

Architrave bracket



The architrave bracket has a longer screw slot in the middle to allow for minor vertical adjustments in bracket placement, before the top and bottom screws are attached.

Standard Brackets

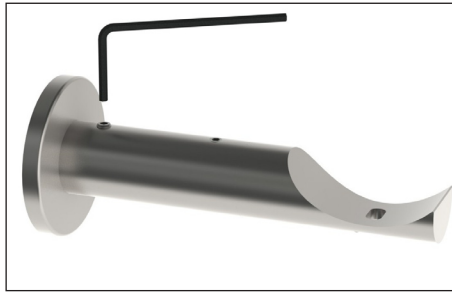
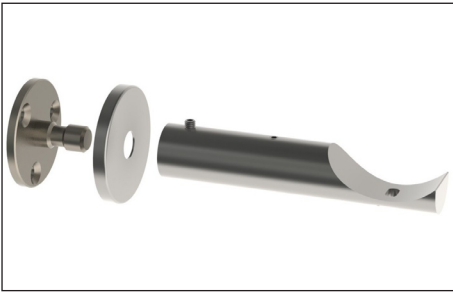

1. Fit the cover plate and barrel to the wall plate, and tighten the grub screw.

2. Place the pole carefully in the bracket cups.

N.B. For Stainless Steel or Brushed Bronze Poles

When using this bracket with stainless steel or brushed bronze poles, the pole will need to be drilled and tapped to take an M4 button head socket screw (supplied).

Use a 3.3mm drill bit to make the hole, and an M4 hand tap to cut the thread.

3. Drill a 3mm pilot hole NO MORE than 10mm deep.

4. Secure the pole with the supplied 12mm screw.

Ring Brackets

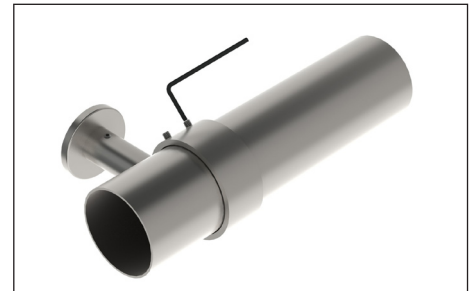
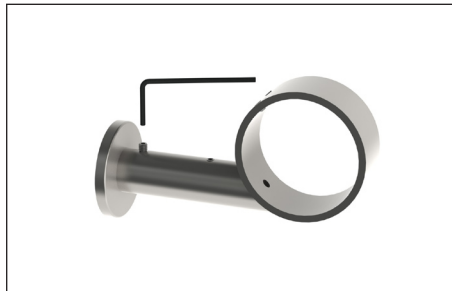

1. Fit the cover plate and the barrel over the wall plate.

2. Tighten the grub screw just enough to hold the bracket barrel on the wall plate but to still allow the bracket to swivel.

3. Insert the pole in the bracket. Rotate the barrel slightly if necessary to obtain the correct alignment then fully tighten all grub screws to secure the pole.

Top Fix Brackets



1. Fit the cover plate and the barrel over the ceiling plate.

2. Tighten the grub screws just enough to hold the bracket barrel on the ceiling but to still allow the bracket to swivel.

3. Insert the pole in the bracket. Rotate the barrel slightly if necessary to obtain the correct alignment then fully tighten all grub screws to secure the pole.

N.B.

The grub screws on the ring section should be turned towards the wall to hide them.

Double Brackets (not for brushed bronze)



Double bracket with cup



Double connector bracket



Double bracket with ring

These brackets are fitted as outlined above.

To Secure the back 19mm pole,

1. Loosen the screw on the top edge of the pole cup
2. Place the pole in position
3. Tighten the screw until the pole is gripped in place



Recess Brackets



1. Unscrew the bracket sleeve from the wall plate.

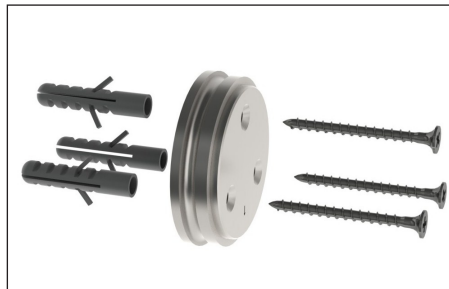

2. Fix the wall plate in position using the screws and wall plugs provided.

N.B. The arrow on the wall plate should be pointing vertically down.



3. Slide the bracket sleeve over the end of the pole and then align the pole with the wall plate.



4. Screw the bracket sleeve back onto the wall plate to secure the pole. The eyelet should be facing down. (This is for attaching the last hook of the curtain).

Support Arms

The support arm can be used with all of our 50mm brackets (except recess brackets). We have shown it with a standard bracket for simplicity.

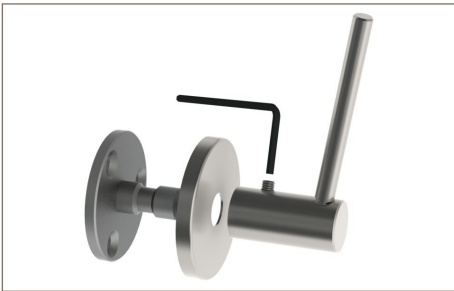

1. Fit the main bracket in place on the wall following instructions on page 3.
2. Loosen the grub screw on the Support arm and remove the wall plate and cover plate.



3. Re-assemble the support arm without the cover plate.



4. Offer up the support arm to the main bracket slotting the arm into the socket on the underside.
5. Mark the position of the screw holes and secure the wall plate to the wall as detailed on page 2.

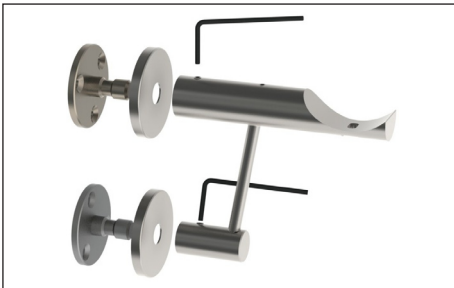

6. Slide the cover plate back over the wall plate and fit the support arm in place.

(You may have to remove the main bracket from its wall plate to do this).

N.B.

The support arm has an adjustable arm which can be unscrewed slightly from the base to take up any slack between the bracket and the support arm.

Architrave Brackets

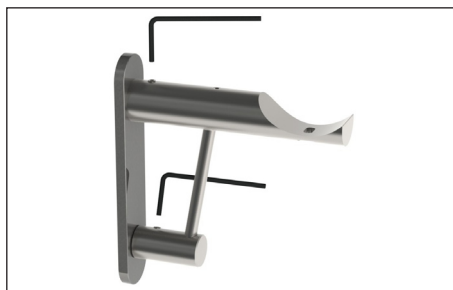
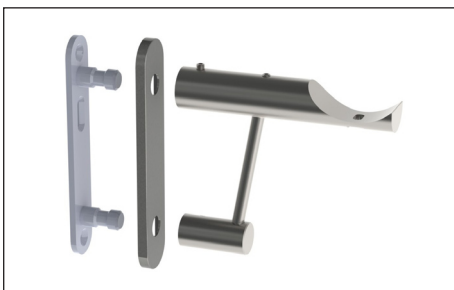

1. Attach the wall plate as shown on page 2.
2. Place the cover plate over the wall plate.
3. Offer the support up to the main bracket, slotting the arm into the socket on the underside.
4. Slide the support and bracket over the lugs on the wall plate.
5. Tighten the grub screws on both the bracket and support arm to secure in place.

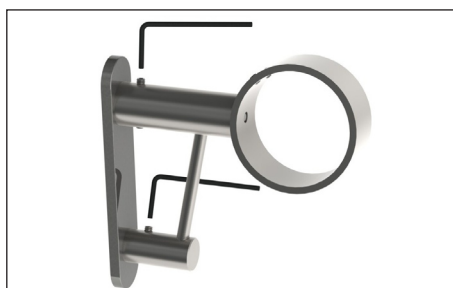

N.B.

The architrave wall plate can be used with any of our face fix brackets if required.

Finials

Mini disc and Bobbin finials are attached to the pole with a grub screw.

1. Loosen the grub screw using the supplied 2mm allen key
2. Slot the finial over the end of the pole and secure in place
3. If your finial is supplied with a ring stop, place it on top of the grub screw.

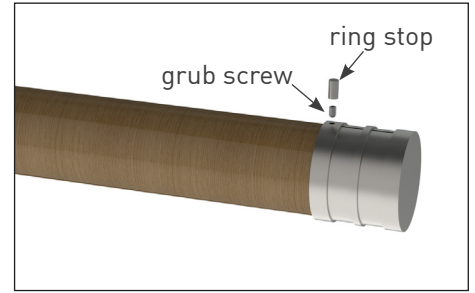
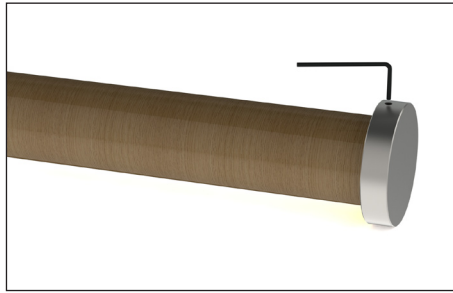

Other finials, supplied with a plate or collar, are fitted in a similar way and further secured with a wood screw.

1. Loosen the grub screw with the allen key supplied
2. Slot the finial over the end of the pole with the grub screw pointing upwards and slightly turned towards the wall so that it is not visible
3. Tighten the grub screw firmly to the pole
4. We recommend that the finial plate is secured to the pole using the supplied 25mm screw.

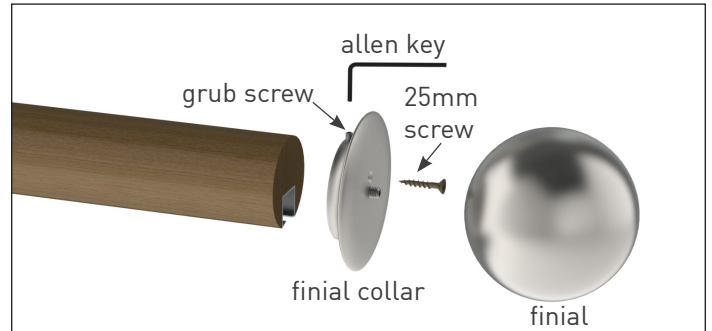

This page intentionally left blank

This page intentionally left blank