

ELGIN[®]
Subsidiary of Federal Signal Corporation

VACTOR[®]
Subsidiary of Federal Signal Corporation

Shop & Safety Essentials Catalog





Elgin and Vactor are proud to announce a new addition to our aftermarket product offering:

Introducing the Elgin/Vactor Shop & Safety Essentials.

We partnered with some of the best and most respected companies in the industry in order to offer you traditional and best-in-industry technologies in products for all of your shop and safety essential needs. These products have all been selected for their quality and will help provide your customers with the right tools for most any job.

Just like our equipment, each of these products are satisfaction guaranteed and backed by a full warranty.

The most attractive feature of the Shop and Safety Essentials is the affordable price. The combination of excellent pricing and professional quality makes all of these products truly an outstanding value.

YOUR **BEST** SOURCE FOR
Essential Shop & Safety Products

Shop Products

- Gloves 2-7
- Flashlights. 8
- Portable Heaters. 9
- Hand Cleaners. 10
- Shop Towels. 11
- Spill Containment 12-14
- Sorbents 15
- Shop Creepers. 16
- Fuel Cans 17

Safety Products

- First Aid Kits & Eye Flush 18
- Respirators 19-22
- Safety Storage. 23
- Safety Eye Wear 24-26
- Fire Extinguishers 27
- Safety Apparel. 27-31
- Safety Accessories. 31-32
- Hearing Protection 33

Welding

- Welding Apparel 34-35

Lubrication Equipment

- Grease Guns 36
- Lubrication Accessories 37-39
- Grease Fittings 40
- Filter Wrenches 41
- Fuel & Oil Transfer 42-44
- Fuel Meters & Nozzles 45
- Fuel Pump Parts 46
- Funnels & Drip Pans 47

Vehicle Solutions

- Vehicle & Trailer Maintenance 48-49
- Wiper Blades 50
- Power Supply 51
- Battery Solutions 51-53
- Tie Downs. 54-55

Lift Equipment

- Lift Equipment. 56-59

Chemicals

- Shop Aerosols 60
- Tire Sealants 61
- Fluid Film & J-B Weld 62
- WD-40®. 63

Hand Tools & Storage

- Striking Tools 64
- Alignment & Pry Bars. 65
- Tool Storage. 66-69

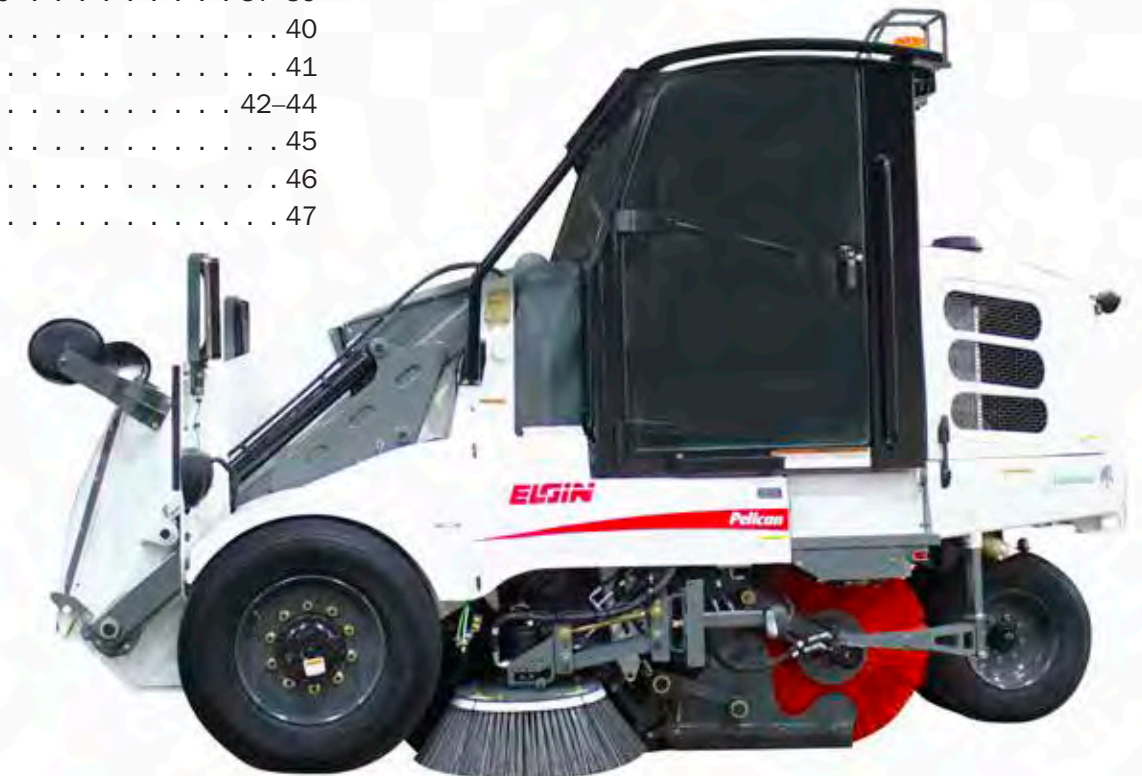

Gloves



Company Branded Mechanics Gloves

- Durable synthetic leather palm
- Breathable form-fitting spandex back
- Flare cuff

Item No.	Size	Logo	Color
ESGBLKE78-L	Large	Elgin	Black
ESGBLKE78-XL	X-Large	Elgin	Black
ESGBLKV78-L	Large	Vactor	Black
ESGBLKV78-XL	X-Large	Vactor	Black
ESGBLKG78-L	Large	Guzzler	Black
ESGBLKG78-XL	X-Large	Guzzler	Black

Mechanics Gloves

- Velcro attachment
- Machine wash, air dry
- Durable synthetic leather palm



ESGBLUE70

ESGRE71

Item No.	Size	Logo	Color
ESGBLUE70-L	Large	-	Blue
ESGBLUE70-XL	X-Large	-	Blue
ESGRE71-L	Large	-	Red
ESGRE71-XL	X-Large	-	Red

Tsunami Grip®

- Cuff is color coded by size, knit wrist
- Single dipped mach finish nitrile
- Outstanding wet oil grip
- Fantastic dexterity, fit & feel
- Dark colors hide dirt
- Applications include electronic assembly, food processing, automotive, construction work and general all purpose light duty material handling use

Item No.	Size
ESG500GM	Medium
ESG500GL	Large
ESG500GXL	X-Large
ESG500G2XL	XX-Large

Tsunami Grip® Air Injected Nitrile

- Purple 13 gauge nylon with a knit wrist
- Outstanding wet oil grip
- Fantastic dexterity, fit & feel
- Air injected Nitrile "breathes" for less hand fatigue and sweat
- Applications include electronic assembly, automotive, construction work, sheet rocking, and general all purpose material handling

Item No.	Size
ESG500M	Medium
ESG500L	Large
ESG500XL	X-Large

Tsunami Grip® New Foam Technology Nitrile

- 15 gauge nylon shell gives silky feel
- Outstanding wet oil grip
- Fantastic dexterity, fit & feel
- Applications include electronic assembly, food processing, automotive, construction work and general all purpose use

Item No.	Size
ESG500NFTM	Medium
ESG500NFTL	Large
ESG500NFTXL	X-Large
ESG500NFT2XL	XX-Large

Gloves

Tsunami Grip® Black Mach Finish Nitrile

- Red 13 gauge nylon shell
- Unique double dipped mach finish nitrile coating provides the grip comparable to true foam/air injected nitrile and has more abrasion qualities
- It also will not saturate through the coating like foam/air injected nitrile
- ANSI level 1 cut resistance
- Outstanding wet oil grip
- Fantastic dexterity, fit & feel
- Applications include electronic assembly, food processing, automotive, construction work, general purpose use and jobs requiring light cut resistance

Item No.	Size
ESG500MFM	Medium
ESG500MFL	Large
ESG500MFXL	X-Large
ESG500MF2XL	XX-Large

Tsunami Grip® New Foam Technology Nitrile with Nitrile Dots

- 15 gauge nylon shell gives silky feel
- Outstanding wet oil grip
- Fantastic dexterity, fit & feel
- Applications include electronic assembly, food processing, automotive, construction work and general all purpose use

Item No.	Size
ESG500NFTDM	Medium
ESG500NFTDL	Large
ESG500NFTDXL	X-Large
ESG500NFTD2XL	XX-Large

Palm Dipped Gloves

- Cut, puncture and abrasion-resistant palm
- Breathable knit back
- Ergonomic, form-fitting design
- Great grip on wet surfaces

Item No.	Size
ESG300-L	Large
ESG300-XL	X-Large

Atlas Fit Latex Palm Gloves



- The ergonomic design and flexible coating make the Atlas Fit latex palm coated gloves the most comfortable and versatile work gloves in the world
- These gloves outperform leather and cotton gloves by providing superior durability, dexterity and fit
- Latex palm coating
- Seamless liner
- Strong tear, abrasion and puncture resistance
- Rough, textured grip

Item No.	Size
ESGHW4400-S	Small
ESGHW4400-M	Medium
ESGHW4400-L	Large
ESGHW4400-XL	X-Large

Atlas Therma-Fit Lined Gloves



- Atlas Therma Fit Gloves are the warm cousin of the most popular and widely recognized work gloves on the market, the Atlas Fit Latex series glove
- The latex is textured for superior grip and the extra liner is ideal for cold weather/environment conditions
- It also gives added cushioning

Item No.	Size
ESGHW4450-M	Medium
ESGHW4450-L	Large
ESGHW4450-XL	X-Large

Large Leather Palm Gloves



- Item No. ESG472-L
- Durable suede leather palm
- Cotton flannel and shirred elastic back
- Heavy duty rubberized safety cuff

Gloves



Suede Palm Mechanics Gloves

- Premium suede deerskin palm is water repellent
- Spandex back for breathability and Lycra finger panels for strength
- Hook & loop wrist closure
- Genuine leather palm outwears synthetic leather by 50%
- Machine wash, air dry

Item No.	Size
ESGHW1065-M	Medium
ESGHW1065-L	Large
ESGHW1065-XL	X-Large



Smooth Grain Cowhide Gloves

- Durable all-purpose work gloves have a shirred elastic wrist
- Rugged, breathable cowhide is both comfortable and long-lasting
- Classic soft tanned leather, keystone thumb and cotton bound hem

Item No.	Size
ESGHW2800-M	Medium
ESGHW2800-L	Large
ESGHW2800-XL	X-Large



Suede Cowhide Gloves

- Soft and durable suede leather
- Tailored keystone thumb
- Shirred elastic back
- Self hem

Item No.	Size
ESGHW2750-M	Medium
ESGHW2750-L	Large
ESGHW2750-XL	X-Large



Large Quilted Heavy Duty Yellow Chore Gloves

Item No. ESGHW3475-L

- Medium weight chore gloves are constructed from 14 ounce 100% cotton flannel, quilted to a moisture wicking polypropylene lining
- Double thickness, full cut design and matching knit wrist to keep out debris
- Great everyday glove—strong and comfortable



Flannel Lined Grain Pigskin

- Premium Pigskin leather work gloves
- Flannel lining
- Great for winter warmth

Item No.	Size
ESGHW2600-M	Medium
ESGHW2600-L	Large
ESGHW2600-XL	X-Large



Large Suede Cowhide Palm

Item No. ESGHW3400-L

- Durable suede leather palm
- Full leather index finger
- Wing thumb
- Leather finger tips
- Knuckle strap
- Shirred elastic back
- 100% cotton flannel back
- 2-1/2" rubberized safety cuff



Reversible Kevlar Blend

- Kevlar brand fiber for high tensile strength relative to its weight—up to five times stronger than steel
- Will not melt, ignite or conduct electricity
- 18% greater cut resistance than standard Kevlar brand fiber for maximum protection



Item No.	Desc.	Size
ESG1KK2200-S	String Knit	Small
ESG1KK2200-M	String Knit	Medium
ESG1KK2200-L	String Knit	Large
ESG1KK2200-XL	String Knit	X-Large
ESG1KK2202-S	Dotted Palm & Back	Small
ESG1KK2202-M	Dotted Palm & Back	Medium
ESG1KK2202-L	Dotted Palm & Back	Large
ESG1KK2202-XL	Dotted Palm & Back	X-Large
ESG1KK2202-2XL	Dotted Palm & Back	XX-Large

Gloves



PVC Chemical Gloves

Item No. ESGHW2441PR

- PVC gloves provide good resistance to anhydrous ammonia, pesticides and acids
- 14" cuff length
- Complies with EN 388:1994 & EN 374-1:1994
- It's our # 1 selling sewer glove



Nitrile-Solve Nitrile Gloves

- 100% Nitrile, 15 mil thickness and a 13" cuff for protection against most pesticides, acids, solvents and caustic chemicals
- Unlined for easy cleaning
- Resistant to abrasion, puncture, cuts and snags

Item No.	Size
ESGHW2400-S	Small
ESGHW2400-M	Medium
ESGHW2400-L	Large
ESGHW2400-XL	X-Large
ESGHW2400-2X	XX-Large



Latex Rubber Grip Gloves

Item No. ESGHW2480PR

- Formulated from natural latex rubber with 14" cuffs for added protection
- Unlined for easy cleanup and freshness
- Abrasion and cut resistant



Flock-Lined Nitrile-Solve Nitrile Gloves

- Flock-lined for additional comfort, these 15 mil, 13" cuff gloves have the same chemical, abrasion and cut resistance as the unlined version

- Lining absorbs perspiration making them cooler to wear and easier to put on and remove
- Non-slip grip finish

Item No.	Size
ESGHW2375-S	Small
ESGHW2375-M	Medium
ESGHW2375-L	Large
ESGHW2375-XL	X-Large
ESGHW2375-2XL	XX-Large



Gloves



Powder-Free 6 mil Nitrile Gloves

- Breakthrough pH5.5 technology made to match healthy skins natural pH5.5 levels to ensure the most comfortable fit yet
- Quadruple washed—no excess chemicals lingering on glove
- Fully textured grip
- Latex-free

Item No.	Description
ESGBL-M	Black Lightning - Medium
ESGBL-L	Black Lightning - Large
ESGBL-XL	Black Lightning - X-Large
ESGBL-XXL	Black Lightning - 2X-Large
ESGOR-M	Orange Lightning - Medium
ESGOR-L	Orange Lightning - Large
ESGOR-XL	Orange Lightning - X-Large
ESGOR-2XL	Orange Lightning - 2X-Large



Heavy Duty Blue Nitrile Lightning Glove

- Powder-free 12" Extended Cuff Latex Gloves
- Ultra thick 15 mil is 4x thicker than standard exam gloves, provides the ultimate barrier protection
- 50 gloves per box

Item No.	Size
ESGBLUE-M	Medium
ESGBLUE-L	Large
ESGBLUE-XL	X-Large
ESGBLUE-XXL	XX-Large



Nitrile Lightning Storm Extended Cuff

- Extended 12" cuff for added protection where you need it most, powder-free
- 9 mil thickness
- Textured fingertips
- 50 gloves per box

Item No.	Size
ESGLS-S	Small
ESGLS-M	Medium
ESGLS-L	Large
ESGLS-XL	X-Large

Gloves



Latex Lightning Glove White

- Powder-free reduced latex
- Extra thick 8 mil latex glove provides superior protection against chemicals and hazards
- Approved for Medical use
- 100 gloves per box

Item No.	Size
ESGWL-M	Medium
ESGWL-L	Large
ESGWL-XL	X-Large



Aloe Power, Nitrile

- With it's proprietary Freeze-Dried Technology, Aloe Power powder-free nitrile gloves gradually bathe hands in aloe to help soothe dry, chapped and cracked hands
- Fully textured for maximum grip in both wet and dry conditions

- 5.5 mil thickness
- 9" length
- 100 gloves per box

Item No.	Size
ESGAPN-M	Medium
ESGAPN-L	Large
ESGAPN-XL	X-Large
ESGAPN-XXL	XX-Large



InTouch Black Nitrile

- Made of 100% Quality Nitrile
- 6 mil thickness
- Fully textured grip

- Powder & latex free
- 100 gloves per box

Item No.	Size
ESGB311-S	Small
ESGB311-M	Medium
ESGB311-L	Large
ESGB311-XL	X-Large
ESGB311-XXL	XX-Large



InTouch Blue Nitrile

- Made of 100% Quality Nitrile, the InTouch Series provides the superior combination of durability and protection against day-to-day hazards at a cost effective price

- 5 mil thickness
- 9" length
- 100 gloves per box

Item No.	Size
ESGQ311-S	Small
ESGQ311-M	Medium
ESGQ311-L	Large
ESGQ311-XL	X-Large



InTouch White Nitrile

- 6.5 mil glove provides excellent protection against chemicals and hazards

- Powder-free
- 9" length
- 100 gloves per box

Item No.	Size
ESGK321-S	Small
ESGK321-M	Medium
ESGK321-L	Large
ESGK321-XL	X-Large



InTouch Vinyl Powdered and Powder Free

- DEHP free
- Strong and heavy
- Cost effective
- Not made from natural rubber latex

- Smooth grip
- Not intended for medical use
- 100 gloves per box

Item No.	Desc.	Size
ESGN331-S	Powder-Free	Small
ESGN331-M	Powder-Free	Medium
ESGN331-L	Powder-Free	Large
ESGN331-XL	Powder-Free	X-Large
ESGP332-S	Powdered	Small
ESGP332-M	Powdered	Medium
ESGP332-L	Powdered	Large
ESGP332-XL	Powdered	X-Large



Flashlights



Septor Flashlight

Item No. ESGER61008

- All LED Technology
- A combination of seven three-way adjustable brilliant white LED bulbs in this flashlight give you hands-free flexibility and long run time

- Adjustable fabric head strap, 90° tilt movement, water-resistant thermoplastic yellow body, rubber-shielded bezel and unbreakable polycarbonate lens
- 3 AAA alkaline batteries included



Trident Flashlight

Item No. ESGER61063

- Xenon Bulb plus LED Technology
- Includes an adjustable fabric head strap, 90° tilting head, spot-to-flood focus, and three levels of lighting for short, medium and long distances
- Rubber-shielded bezel and unbreakable polycarbonate lens

- 3 AAA alkaline batteries included



3C Xenon Flashlight

Item No. ESGER33001

- High intensity Xenon bulb generates up to 12,000 peak beam candlepower
- Five hour continuous runtime on 3 C alkaline batteries (not included)
- Spring loaded clip, sealed switch, shock resistant polymer case, unbreakable polycarbonate lens
- Waterproof, non-conductive, corrosion-proof



4AA Xenon Flashlight

Item No. ESGER68002

- High intensity Xenon bulb generates up to 6,000 peak beam candlepower
- Four hour continuous runtime on 4 AA alkaline batteries (included)
- Shock resistant polymer case, sealed switch, unbreakable polycarbonate lens
- Waterproof, non-conductive, corrosion-proof



4AA LED Flashlight

Item No. ESGER68005

- Seven high-intensity, unbreakable LED's generate up to 27 lumens
- 155 hour continuous runtime on 4 AA alkaline batteries (included)
- Shock resistant polymer case, sealed switch, unbreakable polycarbonate lens
- Waterproof, non-conductive, corrosion-proof



Stinger Rechargeable

Item No. ESGER75014

- Rechargeable 3.6 volt, 1.8 amp nickel-cadmium battery can be recharged up to 1,000 times
- Runtime is one hour continuous use between charges
- Includes two 10-hour snap-in recharger holders with AC and DC charge cords
- Black anodized aluminum housing, unbreakable polycarbonate lens



Ultra Stinger Rechargeable

Item No. ESGER78014

- Produces 75,000 candlepower
- The NiCad 6 volt, 1.8 amp battery is rechargeable up to 1,000 times
- One hour of continuous runtime between charges
- Black anodized aluminum housing is corrosion proof inside and out
- Unbreakable, focusable polycarbonate lens
- Includes two 10-hour snap-in recharger holders with AC and DC charge cords



Clipmate Flashlight

Item No. ESGER61100

- This compact, durable, water-resistant flashlight gives you hands-free operation in three different configurations:
 - 1) as a clip-on light to a hat, straps or equipment
 - 2) clipped to the adjustable head strap
 - 3) carried on its convenient neck lanyard
- 360° rotation projects a white light from three super-bright LED's that is visible for over a mile away!
- 120 hours continuous runtime on 3 AAA alkaline batteries (included)
- An indispensable tool for all outdoor and industrial applications



Stylus LED Penlight

Item No. ESGER65018

- This ultra-slim, powerful penlight is cased in tempered aircraft aluminum with black anodized finish
- The high-intensity 12,000 millicandelas white LED has a 100,000-hour lifetime
- Ten hours continuous runtime with 3 AAAA alkaline batteries (included)
- Water-resistant
- Blink or constant on switch
- Removable tip guard for focusing the beam is included

Portable Heaters

Portable Heaters

- These easy-to-assemble units are CSA-certified and multi-fuel use with no adjustments (kerosene, diesel and fuel oil)
- Units come with an auxiliary power outlet for user-friendly convenience



ESG75TDGD

Forced Air Heater

Item No.	Description
ESG75TDGD	80,000 BTU/h, heats up to 1,750 square feet. 5-gallon fuel tank allows approx. 9 hours of use. Model does not come with tires.



ESG170TDGD

Forced Air Heaters Featuring Dual Heat Technology

Item No.	Description
ESG125TDGD	135,000 BTU/h, heats up to 3,000 square feet. 10-gallon fuel tank allows for approx. 11-13 hours of use. 10" flat-free tires for easy maneuvering and dependability.
ESG170TDGD	180,000 BTU/h, heats up to 4,000 square feet. 13-gallon fuel tank allows for approx. 10-13 hours of use. 10" flat-free tires for easy maneuvering and dependability.



ESG400TDGD

Forced Air Heaters Featuring Dual Heat Technology & *Enhanced Control Panel

Item No.	Description
ESG210TDGD	220,000 BTU/h, heats up to 5,000 square feet. 13-gallon fuel tank allows for approx. 8-10 hours of use. 10" flat-free tires for easy maneuvering and dependability.
ESG400TDGD	400,000 BTU/h, heats up to 8,500 square feet. 29-gallon fuel tank allows for approx. 10 hours of use. 13" pneumatic wheels for easy maneuvering and dependability.

* Enhanced control panel comes with large display area and allows precise temperature control with four diagnostic light indicators for optimum performance

Hand Cleaners



Gent-L-Kleen Smooth Orange

- Orange-based lotion hand cleaner
- Natural orange oils
- Petroleum solvent-free
- NPE-free and VOC-compliant
- pH-balanced and biodegradable
- Five skin care ingredients

Item No.	Weight
ESGG23116	15 oz.
ESGG25218	1 Gallon



Gent-L-Kleen Pumice Orange

- Orange-based lotion hand cleaner
- Natural orange oils with fine-grain, American pumice
- Petroleum solvent-free
- NPE-free and VOC-compliant
- pH-balanced and biodegradable
- Five skin care ingredients

Item No.	Weight
ESGG25116	15 oz.
ESGG23218	1 Gallon



Pumice Grime Grabber

- Traditional skin cleansing gel
- Water-soluble and biodegradable
- VOC-compliant and NPE-free
- Six skin care ingredients

Item No.	Weight
ESG31412	14 oz.
ESGGC34560	4.5 lb.



Scrubs Hand Cleaning Wipes

Item No. ESGCH2401BU

- Sheet Size: 10" x 12.25"
- Quantity per canister: 72
- A powerful hand and surface degreasing cleaner that's gentle on your skin
- Multi-purpose wet wipe degreaser cuts through oil, tar, grease, paint, lubricants, ink, wax, adhesives and more



1 Gallon Gent-L-Kleen Heavy Duty Citrus with Pumice

Item No. ESG121422

- Premium, citrus-based lotion hand cleaner
- Natural citrus oils and fine-grain, American pumice
- Petroleum solvent-free
- NPE-free and VOC-compliant
- pH-balanced and biodegradable
- Nine skin care ingredients



Wall Mount Bracket

Item No. ESG10002

- Fits one gallon pump-top jugs
- Stainless steel
- Pre-drilled holes



Wall Mount Dispenser

Item No. ESG45116

- Fits 4.5 lb cartridge
- Rugged, non-corrosive plastic
- No gear or ratchets
- Black finish
- One-hand operation



Gent-L-Kleen Hand Wipes 90 Count Scrubber

Item No. ESG319060C

- Solvent-free, VOC and NPE-free
- Towels stay moist for hours
- Textured scrubber towel for ultra cleaning power
- Six skin care ingredients
- Multi-purpose wipes for hands, tools, surfaces and more!



Lava Heavy Duty Hand Cleaner

Item No. ESG10185

- Contains added moisturizers to help keeps hands smooth and soft—even with repeated usage
- Contains Pumice for powerful hand cleaning action

Shop Towels



Shop Products



Shop Towels 100 Count Box

Item No. ESG5025001

- Sheet size: 9" x 16.75"
- Quantity per box: 100
- Packaged in a portable pop up dispenser box allows you to grab one sheet at a time



Shop Towels 200 Count Box

Item No. ESG55202

- Sheet size: 9" x 13"
- Quantity per box: 200
- Packaged in a cardboard center-pull dispenser box with convenient carrying handle



Shop Towels

Item No. ESG54416

- Sheet size: 11" x 9.4"
- Quantity per roll: 64
- 6 pack quantity
- Soft on hands and face, absorbent, and won't fall apart when wet
- Ideal for all medium to heavy-duty general purpose wiping applications
- Blue shop towels help hide grease and grime better than white shop towels allowing for more use before being discarded



Big Grip

Item No. ESG55208

- Sheet Size: 11" x 13"
- Quantity per bucket: 200
- Bucket Shop Towels are perfect for jobs outside or wet work sites as it is designed to keep your towels clean and dry until they are needed



Big Grip Refill

Item No. ESG55207

- Sheet Size: 11" x 13"
- Quantity per roll: 200
- Use as a refill for the Big Grip (Item No. ESG55208) or as a stand alone center-pull shop towel dispenser

Spill Containment



SENTRY Spill Response Drum

Item No. ESGSP1620EA

- 6 gallon pick-up capacity
- 10 gallon drum contains enough CHEMSORB® sorbent to absorb 6 gallons of liquid spill
- Kit includes:
 - 3 CHEMSORB® Diking Tubes
 - 6 Small CHEMSORB® Pillows
 - 2 HazMat disposable bags
 - 1 pair splash goggles
 - 1 pair rubber HazMat boots
 - 1 pair 15 mil Nitrile gloves
 - 2 HazMat labels
 - 2 non-hazardous waste labels
 - 1 parts reorder form



SENTRY Spill Response Drum

Item No. ESGSP1640EA

- 20 gallon pick-up capacity
- 30 gallon drum contains enough CHEMSORB® sorbent to absorb 20 gallons of liquid spill
- Kit includes:
 - 10 CHEMSORB® Diking Tubes
 - 4 CHEMSORB® Pillows
 - 4 HazMat disposable bags
 - 2 Tychem SL Saranex Coveralls
 - 2 pair splash goggles
 - 2 pair rubber HazMat boots
 - 2 pair 15 mil Nitrile gloves
 - 1 roll caution tape
 - 4 HazMat labels
 - 4 non-hazardous waste labels
 - 1 parts reorder form



SENTRY Spill Response Drum

Item No. ESGSP1660EA

- 30 gallon pick-up capacity
- 55 gallon drum contains enough CHEMSORB® sorbent to absorb 30 gallons of liquid spill
- Kit includes:
 - 15 CHEMSORB® Diking Tubes
 - 10 CHEMSORB® Pillows
 - 4 HazMat disposable bags
 - 2 Tychem SL Saranex Coveralls
 - 2 pair splash goggles
 - 2 pair rubber HazMat boots
 - 2 pair 15 mil Nitrile gloves
 - 1 roll caution tape
 - 4 HazMat labels
 - 4 non-hazardous waste labels
 - 1 parts reorder form



Portable Insulated Decontamination Kit

Item No. ESGKT1540

- Designed for personal cleanup in the field from chemical spills
- Lightweight, bright yellow nylon bag is easy to identify from a distance and is insulated to ensure that enclosed liquids meet the EPA's "usable temperature" mandate
- Complies with: EPA Reg. 40 CFR 170
- Kit includes:
 - 4 Extra large single-use towels
 - 3 One-gallon portable water bottles
 - 2 16-oz. bottle of sterile, buffered, isotonic eyewash
 - 1 4-oz. bottle liquid soap
 - 1 disposable coverall/ modesty garment
 - 1 weather-resistant, insulated carrying case (14.5" x 12.5" x 12.5")
 - 1 bilingual instruction sheet

Spill Containment



Commando® Spill Containment Kit

Item No. ESGKT1120EA

- Ideal for vehicles transporting liquid chemicals, chemical handlers and haulers, around mixing and storage areas
- Pickup rating is 5 gallons of liquid per kit
- Packed in a highly visible yellow, chemical resistant carry bag
- Slim, mobile spill response kit fits easily in your vehicle and may be hung on the warehouse or shop wall to give you immediate response to chemical spills
- Kit includes:
 - 2 CHEMSORB® Diking Tubes (3" x 48")
 - 4 CHEMSORB® Pillows (16" x 9" x 2")
 - 2 HazMat disposable bags
 - 1 pair 15 mil Nitrile gloves
 - 1 pair safety goggles
 - 1 pair Tychem SL Saranex boot covers
 - Instruction sheet



Minuteman® Spill Containment Kit

Item No. ESGKT1000EA

- Fits easily in any vehicle sprayer, nurse tank or chemical transport truck, and can be wall hung around your plant and warehouse for visibility and easy access
- Keep your spill response items organized and ready for use
- Packed with the key products you need to clean up a hazardous spill
- Pickup rating is 5-6 gallons of liquid per kit
- Comes in a portable, highly visible orange nylon duffel pack
- Kit includes:
 - 2 CHEMSORB® Sorbent Pillows (26" x 16" x 2")
 - 3 CHEMSORB® 48" Diking Tubes
 - 1 pair 15 mil Nitrile gloves
 - 1 pair safety goggles
 - 1 pair Tychem SL Saranex boot covers
 - 2 HazMat disposable bags with labels



Spill Containment Pallets

- Constructed of high density polyethylene (HDPE) for excellent durability and chemical resistance
- Features a sump capacity of 66 gallons (ESG1645) or 132 gallons (ESG1640) and black HDPE flat top grating which removes easily for cleaning
- Forkliftable design with drain plug
- Low Line Pallets are made of 100% recycled polyethylene—only 9" tall
- Offers a comfortable working height during pumping or waste collection activities
- Optional Pallet Ramp simplifies loading
- EPA and SPCC Compliant
- Made of recycled polyethylene, these pallets resist chemical attack from hazardous acids, caustics and solvents
- Oversized sump holds the contents of a 55-gallon (200-L) drum in the event of leak or rupture—meeting or exceeding the most stringent spill containment regulations

Item No.	Dimensions	Drum	Capacity
ESG1640	52.5" x 51" x 13.25" (Yellow)	4	132 Gallon
ESG1645	51.5" x 51.5" x 8" (Yellow)	4	66 Gallon
ESG28673	55" x 55" x 9" (Black)	4	79 Gallon
ESG28635	49" x 49" x 10.25" (Black)	4	73 Gallon
ESG28634	49" x 49" x 10.25" (Yellow)	4	73 Gallon

Spill Containment

CHEMSORB® Twin Pillows

Item No. ESGSP1750BX



- Keep these extra-large sorbent pillows on hand for additional emergency pick-up capacity, for kit refills and to keep around storage & mixing areas. Ideal for pesticide spills!
- Generously sized pillows measure 26" x 16" x 2" and provide 1-1/2 to 2 gallons of pickup capacity per pillow

- Compliance OSHA 29 CFR 1910.119-120

CHEMSORB® Single Pillows



- CHEMSORB® has been tested with over 100 industrial chemicals including acids, alkalis, hydrocarbons, pesticides and chlorinated compounds. You can use it to stop virtually any type of spill, without guesswork, without mistakes. CHEMSORB® will not react with hazardous materials or add any pollution problems of its own.

Item No.	Size	Qty./Box
ESGSP1765BX	18" x 9" x 2"	20
ESGSP17351	8.5" x 8.5" x 2"	20
ESGSP17370	8.5" x 17.5" x 2"	12
ESGSP20583	17.5" x 17.5" x 2"	12
ESGSP17379	17.5" x 34" x 2"	12

CHEMSORB® Diking Tubes



- Use to surround and contain a spill—and the CHEMSORB sorbent filling immediately starts soaking up the spill fast!

- Compliance OSHA 29 CFR 1910.119-120

Item No.	Size	Skin	Qty./Box
ESGSP1790BX	3.5" dia. x 48" length	Woven	20
ESGSP20296	3.5" dia. x 48" length	Non-Woven	5
ESGSP20586	3.5" dia. x 10' length	Non-Woven	5
ESGSP21130	5" dia. x 10' length	Non-Woven	5

CHEMSORB® Bulk Loose Sorbent



Item No. ESGSP1780BX

- Lined box contains 4 cubic feet of loose CHEMSORB sorbent and includes a scoop for easy dispensing where you need it

- Sorbent has a total pickup capacity of 16 gallons of liquid spill



CHEMSORB® Polybags

Item No. ESGSP2105

- Keep these convenient, reclosable bags near areas of potential hazardous drips and spills
- Each dispenser bag contains 0.5 cubic feet of sorbent and absorbs 2 gallons of liquid
- Packed 4 bags per box

CHEMSORB® Bulk Variety Pack



Item No. ESGSP17390

- Convenient bulk pack contains a variety of CHEMSORB sorbent diking tubes and pillows for larger spill response and backup, refills for kits, and general maintenance and cleanup of spills, drips and leaks
- Contains: 16 Diking Tubes (3" x 43"), 10 Pillows (10" x 10"), 4 Two-Liter Pillows (18" x 18"), 2 HazMat Disposal Bags and 2 HazMat Labels

CHEMSORB® Spill & Leak Sorbent Trays



- Use these low profile drip pans for general spill, drip and leak maintenance, under and around equipment, drums, hydraulic lines—wherever you need it

- Suitable for aggressive chemicals, HazMat leaks, oils and general maintenance applications

- Low profile, inert black plastic drip pans come with 2 each, replaceable, CHEMSORB Universal Sorbent Pillows

- Refill Pillow Packs are available

Item No.	Pan Size	Pillow Size	# of Pans	# of Pillows
ESGSP17580	11" x 21" x 2"	11" x 21"	12	12
ESGSP17450	11" x 11" x 2.5"	10" x 10"	12	24

CHEMSORB® Sorbent Pillow Refill Pack



- Replacement pillows for drip pans

Item No.	Pillow Size	# of Pillows
ESGSP17485	11" x 21"	12
ESGSP17455	10" x 10"	24

Sorbents

Oil Only Heavy-Duty Absorbent Pads

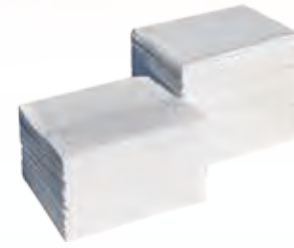

Item No. ESG83100

- Pad Size: 15" x 19"
- Durable meltblown spunbond coverstock on top and bottom of pads (and rolls) with an absorbent core made with recycled shop towel fibers

- Made with 60% cotton

Oil Only Heavy-Duty Absorbent Rolls



Item No. ESG83150

- Roll Size: 28.5" x 125'
- Perforated every 19" across and down the center of the length of the roll

Oil Only Heavy-Duty Absorbent Split Rolls



Item No. ESG83160

- Roll Size: 14.25" x 125'
- Perforated every 19" across but not down the center of the length of the rolls

General Purpose 4' Absorbent Socks



Item No. ESG22868

- Sock Size: 3" x 4'
- Made with 70% recycled cellulose fiber
- Absorbs both water and oil based fluids such as diesel fuel, transmission fluid, hydraulic fluid, coolants, grease, paint and many other fluids

General Purpose Medium-Duty Absorbent Pads



Item No. ESG23200

- Pad Size: 15" x 19"
- More absorbent and a more cost effective alternative than the leading competitor's meltblown absorbent pads/rolls

General Purpose Medium-Duty Absorbent Rolls



Item No. ESG23250

- Roll Size: 28.5" x 125'
- Perforated every 19" across and down the center of the length of the roll

General Purpose Medium-Duty Absorbent Split Rolls



Item No. ESG23260

- Roll Size: 14.25" x 125'
- Perforated every 19" across but not down the center of the length of the rolls

Heavy-Duty Absorbent Barrel Top Pads



Item No. ESG22866

- Pad Size: 22" diameter
- Made with 70% recycled cellulose fibers

Walk-On Rag Rug



Item No. ESG27036

- Roll Size: 36" x 150'
- Absorbent and a very durable walk-on mat
- Ideal to place in steady foot traffic areas where over-spray, leaks, drips and spills can occur

Shop Creepers

Two Position Z-Creepers

Item No. ESG91000

- 2 in 1 creeper that is designed to be folded in a "Z" shape for use as a mechanics seat or unfolded for use as a mechanics creeper
- Transforms with no tools in seconds
- Professional grade rated for 450 lbs.
 - Thick padded cushions for extended comfort
 - 40" Steel frame construction
 - Six 3" polyurethane, oil resistant, full bearing casters for easy movement
 - Size 41-1/4" x 19-5/8" x 6-1/8"



Tool Box Creeper

Item No. ESG92450

- Heavy duty creeper seat with tool storage provides a convenient storage solution for common tools used for brake jobs, detailing, and body work
- Three full suspension locking tool drawers
- Professional grade rated for 450 lbs.
 - 4 full bearing 3" casters along with polyurethane wheels to give you easy, smooth and effortless maneuvering in your garage
 - Size 14" x 14" x 15"



Fuel Cans



Type 1 Metal Gas Cans

- Spring-loaded, self-closing lid controls vapors, automatically closes after filling/pouring
- Comfortable rounded grip doesn't cut into hand
- Rugged 24 gauge construction is guaranteed leak-proof
- Reinforcing ribs strengthen side wall for extra protection
- Premium coated steel is chemically resistant to handle gasoline, diesel fuel, kerosene and other chemicals
- Accepted container under CARB
- Complies with OSHA 29 CFR 1910.106 and NFPA Code 30 requirements
- FM, UL, ULC certified

Item No.	Capacity
ESGSP7012EA-R	1 Gallon
ESGSP7013EA-R	2 Gallon
ESGSP7015EA-R	5 Gallon



Universal Pour Spout Funnel

Item No. ESGSP7014EA

- Attaches quickly for leak-free, safe pouring
- FM certified
- For use with Type 1 Metal Gas Cans
- The innovative hinged design takes up less space during storage and allows you to fill or pour from the can without removing the funnel



Type II Metal Gas Cans with 5/8" Hose

- Type II fuel cans offer two openings, one to fill and one to pour, with a built-in flexible metal hose
- Self-closing, leak-proof lid provides security from spills and leaks
- The one-gallon can features a trigger release handle, larger capacity cans have a swinging handle
- All models are equipped with an FM-tested dual-density flame arrestor that reliably dissipates heat to stop flashback ignition
- To protect against rupture or explosion, positive pressure relief mechanism automatically vents between 3 and 5 PSIG
- All cans are heavy-duty, high grade coated steel construction with special reinforcing ribs to strengthen sidewalls
- Finished in a tough powder-coat paint
- Meets OSHA and NFPA requirements, as well as FM, UL, ULC certification

Item No.	Capacity
ESGSP7001EA	1 Gallon
ESGSP7002EA	2 Gallon
ESGSP7005EA	5 Gallon

Plastic Fuel Containers

- Spout closes automatically with an airtight seal
- Wide base design and lower center of gravity reduce the chance of tipping over
- Easy-flow/spill-proof spout for safe fuel storage and easy pouring
- Portable fuel containers come equipped with EPA/CARB compliant spouts and ANSI standards



Item No.	Capacity	Fuel Type
ESG1200	1 Gallon	Gasoline- Red
ESG2300	2 Gallon	Gasoline - Red
ESG5600	5 Gallon	Gasoline - Red
ESG8600	5 Gallon	Diesel - Yellow
ESG7600	5 Gallon	Kerosene - Blue



First Aid Kits & Eye Flush

Compact First Aid Kit

Item No. ESG6082

- 94 piece kit
- Inner gasket seals out moisture so contents stay dry and ready to use
- Fits in vehicle glove box or can easily be wall-mounted
- Rust-proof, durable polypropylene case



10 Person First Aid Kit

Item No. ESGKT0210

- 65 piece first aid kit is packed in a weatherproof plastic case with an inner gasket that seals out moisture
- Kit fits in a vehicle glove box or can be mounted on a wall with screws



25 Person First Aid Kit

Item No. ESGKT0225

- 200 piece first aid kit is packed in a weatherproof plastic case with an inner gasket that seals out moisture
- Kit can be mounted on a wall with screws



50 Person First Aid Kit

Item No. ESGKT2050

- 200 piece first aid kit is packed in a weatherproof plastic case with an inner gasket that seals out moisture
- Kit can be mounted on a wall with screws



100 Person First Aid Kit

Item No. ESGKT0260EA

- 3-shelf station is designed for larger facilities and contains supplies for up to 100 employees
- 20-gauge steel case with interior door pouches and shelves



Soft Pack Travel First Aid Kit

Item No. ESGKT7110

- 55 piece first aid kit easily fits in a vehicle glove box, travel bag or tool box
- Light-weight soft-pack has a sewn on Velcro® strip attachment that can be wall mounted or converted to a "belt" kit



Single Bottle Flush Station

Item No. ESGFE2050EA

- Install this single 32 ounce bottle wall unit wherever emergency eyewash availability is required
- Single-use bottle is dated for freshness and replacements may be ordered separately
- Unit mounts on wall with screws (not included)



Portable Eyewash System

Item No. ESGFE2500EA

- This portable eyewash provides a steady water flow and first aid relief virtually anywhere
- Easier to transport with its 9.0 gallon capacity, it delivers a full 15 minutes of flushing time with 0.4 gallons/minute and meets full compliance to ANSI Z358.1 2004
- New design allows entire contents to be utilized for 15 minute flushing requirement, allowing the unit to be made smaller and more portable
- Constructed of FDA high-density polyethylene material.
- Eyewash is activated by pulling down lever, which protects outlet nozzles when not in use
- Hangs on bracket that easily bolts to a wall or on vehicle (bracket included)



Emergency Saline Eye Flush

- Buffered, sterile saline eye flush is sealed and dated for freshness

- Individual plastic bottles for use as portable emergency eye flush wherever you need it, or as replacement bottles for eye flush stations



Item No.	Capacity
ESGFE2042EA	1 oz.
ESGFE2043EA	4 oz.
ESGFE2041EA	16 oz.
ESGFE2040EA	32 oz.

Respirators

2301 N95 Particulate Respirators with Valve

Item No. ESGRS2300PK

- Ventex® valve gets hot air out faster, so breathing resistance is reduced and workers stay cooler
- Convenient 5-pack personal locker has a separate compartment for the mask being used
- Perfect for hot, humid, dusty conditions
- Dura-Mesh® flame-retardant shell protects the filter media so it stays cleaner longer and resists collapsing

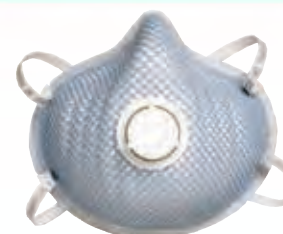

Utility Dust Mask

Item No. ESGRS2114BX

- Offers relief from non-toxic dusts, pollen, animal dander and other nuisance level dusts at exposures below the OSHA Permissible Exposure Limit (PEL)
- Weighs less than 1/3 ounce and will not collapse when it becomes wet
- Not NIOSH approved—designed for non-toxic dusts only
- Box of 50 masks



Saf-T-Fit Plus N95 Respirator

- NIOSH approved for use with particulate aerosols free of oil
- Low breathing resistance, lightweight and latex free
- Incorporates humidity-resistant filter media and durable suspension straps
- Color-coded facepiece in three sizes to fit a wider range of facial features
- Box of 20 masks



Item No.	Size
ESGRS1105-S	Small
ESGRS1105-ML	Medium/Large
ESGRS1105-XL	X-Large

Freedom® Disposable Respirator Organic Vapor/R95 Filters



- Pre-assembled with cartridges/prefilters and ready to use
- Features rolled edges, a broad sealing flange, chin port and forward angled nose piece for a secure, comfortable fit
- Eliminates assembly mistakes and the need for cleaning and maintenance
- Ideal for extremely dusty or dirty applications where cleaning is difficult, including paint and pesticide spraying, welding, primary metals, automotive and chemical operations

Item No.	Size
ESGRS2155EA-S	Small
ESGRS2155EA-M	Medium
ESGRS2155EA-L	Large

2200 N95 Particulate Respirators

Item No. ESGRS2120BX-ML



- Ideal for hot, humid, dusty conditions
- The Dura-Mesh shell resists collapsing and the Softspun lining provides added comfort and durability
- This mask's molded nose bridge seals easily without a metal nose band
- NIOSH certified to have a filter efficiency level of 95% or greater against particulate aerosols free of oil
- Box of 20

P95 Disposable Respirator



- NIOSH-approved P95 protection for extended use with contaminant aerosols containing oil
- Exhalation valve for ease of breathing and exceptional comfort during extended wear
- Full sealing flange for best fit and protection, and latex-free
- Suggested for use in sanding, grinding, sweeping, brazing, torch cutting, soldering, certain welding applications and for hot, dusty, dry operations
- Box of 10 respirators

Item No.	Size
ESGRSP9535-ML	Medium/Large
ESGRSP9535-XL	X-Large

Respirators



2300 N95 Particulate Respirators with Valve

Item No. ESGRS2130BX

- Easier to wear with a pinch-free nose bridge—comfortably fits the contour of your nose without a metal nose band
- The Dura-Mesh® flame-retardant shell protects the filter media so it stays cleaner longer and resists collapsing, even in heat and humidity

- The exclusive Ventex valve gets hot air out faster, so breathing resistance is reduced and workers stay cooler
- Elastic straps are securely attached so they don't break at the seal
- Available in a box of 10, or in a convenient 5-pack personal locker with a separate compartment for the mask being used

Freedom® Disposable Respirator, Uni-Sorb® Multicontaminant/P100 Filter



- Pre-assembled with Multi-contaminant Unisorb cartridges and P100 prefilters and ready to use
- Features rolled edges, a broad sealing flange, chin port and forward angled nosepiece for a secure, comfortable fit
- Ideal for extremely dusty or dirty applications where cleaning after use is difficult, including paint and pesticide spraying, welding, primary metals, automotive and chemical operations

- Eliminates assembly mistakes and the need for cleaning and maintenance

Item No.	Size
ESGRS2158-M	Medium
ESGRS2158-L	Large



Comfo Classic Respirator

- The SoftFeel silicone facepiece of the Comfo Classic respirator is an exclusive formulation that improves the pliability and softness of the material, significantly increasing the comfort factor
- The silicone formulation is resistant to chemicals and oils and cleans easily
- Supplied as facepiece only—purchase cartridges and filters separately

Item No.	Size
ESGRS1600-S	Small
ESGRS1600-M	Medium
ESGRS1600-L	Large



MSA Advantage 3000 Full Facepiece Respirator

- Wraparound lens combined with a soft, pliable silicone facepiece
- Lens has scratch resistant coating, is optically correct, and provides superior visibility and peripheral vision with no distortion
- Meets ANSI Z87.1 2003. Includes rubber harness
- Facepiece only—order cartridges and filters separately

Item No.	Size
ESGRS1300-S	Small
ESGRS1300-M	Medium
ESGRS1300-L	Large

Respirators



MSA Advantage 200LS Respirator Facepiece

- The AnthroCurve Sealing Surface instantly conforms to each wearer's unique facial characteristics and the patented MultiFlex system equalizes pressure on the face-seal area
- Two-piece, split neck strap
- Facepiece only—order cartridges and filters separately

Item No.	Size
RFRS1000-S	Small
RFRS1000-M	Medium
RFRS1000-L	Large



MSA Comfo Cartridges & Filters N95 Prefilters - 816662

Item No. ESGRS1050PK

- N95 Prefilters for MSA Comfo Classic air purifying respirators, or MSA Advantage respirators with cartridge adapter (Item No. ESGRS1175PR)
- Application: For protection against solid and liquid non-oil based particulates (95% efficiency)
- Two required per respirator



MSA Comfo Cartridges & Filters GMA-OV Vapor Ctg - 464031

Item No. ESGRS1700BX

- Organic Vapor Cartridges for MSA Comfo Classic air purifying respirators, or MSA Advantage respirators with cartridge adapter (Item No. ESGRS1175PR)
- Application: Organic vapors



MSA Comfo Cartridges & Filters - GMA- P100 Organic Vapor Ctg with P100 Filter - 815178

Item No. ESGRS1100BX

- Organic Vapor Cartridges with P100 Filter for MSA Comfo Classic air purifying respirators, or MSA Advantage respirators with cartridge adapter (Item No. ESGRS1175PR)
- Application: Organic vapors and solid and liquid particulates that may contain oil (99.97% efficiency)



MSA Comfo Cartridges & Filters - GME-P100 Multi-Contaminant Ctg with P100 Filter - 815182

Item No. ESGRS1650BX

- Multicontaminant Cartridge with P100 Filter for MSA Comfo Classic air purifying respirators, or MSA Advantage respirators with cartridge adapter (Item No. ESGRS1175PR)
- Application: Organic vapors, chlorine, sulfur dioxide, chlorine dioxide, hydrogen chloride, hydrogen sulfide (escape only), ammonia, methylamine, formaldehyde, hydrogen fluoride, solid and liquid particles that may contain oil (99.97% efficiency)



MSA Comfo Cartridges & Filters - Snap on Prefilter Cover - 489353

Item No. ESGRS1075EA

- Prefilter cover for MSA Comfo Classic air purifying respirators, or MSA Advantage respirators with cartridge adapter (Item No. ESGRS1175PR)
- 2 required per respirator



MSA Advantage Cartridges & Filters - GMA Organic Vapor Ctg - 815355

Item No. ESGRS1150PK

- Organic Vapor Cartridges for MSA Advantage air purifying respirators
- Application: Organic vapors



MSA Advantage Cartridges & Filters - N95 Prefilters - 815394

Item No. ESGRS1155PK

- N95 Prefilters for MSA Advantage air purifying respirators
- Application: For protection against solid and liquid non-oil based particulates (95% efficiency)
- Two required per respirator



Respirators



MSA Advantage Cartridges & Filters- GME P100 Multi-Contaminant Ctg with P100 Filter - 815366

Item No. ESGRS1200PK

- Multi-contaminant cartridge with P100 Filter for MSA Advantage air purifying respirators

- Application: Organic vapors, chlorine, sulfur dioxide, chlorine dioxide, hydrogen chloride, hydrogen sulfide (escape only), ammonia, methylamine, formaldehyde, hydrogen fluoride, solid and liquid particles that may contain oil (99.97% efficiency)



MSA Advantage Cartridges & Filters- Snap-On Prefilter Cover - 815392

Item No. ESGRS1160PR

- Prefilter covers for MSA Advantage air purifying respirators



MSA Advantage Cartridges & Filters- Advantage Cartridge Adapter -809999

Item No. ESGRS1175PR

- Allows NIOSH-approved use of Comfo cartridges, which are threaded, on any Advantage air purifying respirator—providing additional flexibility



Respirator Smoke Fit Test Kit Complete Fit Test Kit

Item No. ESGRS2201EA

- For qualitative fit testing of air purifying respirators and recommended for meeting the requirements of all applications
- Meets OSHA protocol for fit testing with smoke

- Invokes involuntary response, eliminating low sensitivity to other methods and incorrect reporting of results
- Includes irritant smoke tubes, aspirator assembly, record form and protective storage pouch



Respirator Smoke Fit Test Kit Replacement Smoke Tubes

Item No. ESGRS2202BX

- Replacement smoke tubes for the respirator smoke test kit



Respirator Fit Test Ampules

Item No. ESGRS2200BX

- When activated, ampules give off a non-irritating odor of banana oil (Iso Amyl Acetate)
- If banana odor is detected by wearer, respirator should be adjusted or replaced

- Designed for interim testing with fully fit-tested respirators



Reusable Respirator Storage Bags

Item No. ESGRS2214EA

- These tough 10 mil thick poly bags feature a zipper for positive closure

- Large size (14"x16") suitable for half or full-face respirators
- Respirator cleaning instructions are printed on each bag



Bitrex™ Respirator Fit Test Kit, Complete Fit Test Kit

Item No. ESGRS2041EA

- New disposable glass ampules make pouring solution into nebulizers easier and reduces the chance of contamination

- Kit includes hood with drawstring, 2 nebulizers, 6 sensitivity solution ampules and 6 test solution ampules



Bitrex™ Sensitivity Solution Refills

Item No. ESGRS2041-01

- Sensitivity solution refills for use with Bitrex Fit Test Kits



Bitrex™ Test Solution Refills

Item No. ESGRS2041-02

- Test solution refills for use with Bitrex Fit Test Kits

Safety Storage



Pesticide Storage Cabinets

- Designed for pesticide users in lawn care, golf course maintenance, agriculture, pest control and commercial nurseries

- Each cabinet features sturdy galvanized steel shelves, adjustable on 4-3/4" centers that will support 350 lbs.

- Internal and external welding construction

- 18 gauge steel reinforced double wall panel construction with 1-1/2" air space

- 2" raised leak proof sill

- 2" vent with fire baffle and cap

- Ground connection

- Baked on powder coating finish is high-gloss and lead free

- Doors have 3 point key locks

Item No.	Description
ESGSP3230GR	30 Gallon, 1 Shelf
ESGSP3245GR	45 Gallon, 2 Shelves



Chemical Storage Cabinets

- For safe storage of flammable materials

- Each cabinet features galvanized steel shelves, adjustable on 4-3/4" centers that support 350 lbs.

- Galvanized steel leveling legs

- Internal and external welded construction

- 18 gauge steel reinforced double wall panel construction with 1-1/2" air space

- 2" raised leak proof sill

- 2" vent with fire baffle and cap

- Ground connection

- Baked on powder coating finish is high-gloss and lead free

- Doors have 3 point key locks

- Large "FLAMMABLE" labels are included

Item No.	Description
ESGSP3230YL	30 Gallon, 1 Shelf
ESGSP3245YL	45 Gallon, 2 Shelves
ESGSP3260YL	60 Gallon, 2 Shelves



Safety Eye Wear

Safety Eye Wear

- TPR material increases its grip as it becomes moist to keep them on your face
- Tapered lenses eliminate refraction and block 99.9% of UVA/UVB/UVC rays
- Fog and scratch resistant lenses
- Exceeds ANSI Z87.1+2010 safety standards
- Frames consists of a flexible and durable TR90/Nylon compound material and wrap around with no side shield distortion



ESGXF111
*Fits over glasses

ESGTSKAP218



ESGSW116

ESGSW116CF

Dallas® Safety Eye Wear

- Features a lightweight frame with flexible bayonet temples that are fully coated!
- Stylish wraparound lens design for side impact protection that comfortably fits a wide variety of users
- New metallic color frame options offer fashion and functionality combined with a sleek style that has a lightweight comfortable fit



Item No.	Description
ESGFE4200-C	Polished Black Frame, Clear Nose, Black Temples, Clear Lens
ESGFE4200-IO	Polished Black Frame, Black Temples, Indoor/Outdoor AF Lens
ESGFE4200-M	Polished Black Frame, Black Temples, Silver Mirror Lens

Item No.	Lens	Frame
*ESGXF111	Clear	Black
* ESGXF116	Smoke	Black
ESGDZ111	Clear	Gloss Black Nylon
ESGDZ116	Smoke	Gloss Black Nylon
ESGSW111	Clear	Gloss Black Nylon
ESGSW116	Smoke	Gloss Black Nylon
ESGSW116CF	Smoke	Camouflage Nylon
ESGTSM216	Polarized Smoke	Rubberized Matte Black Nylon
ESGSK116	Smoke	Gloss Silver Gradient Nylon
ESGTSKAP218	Polarized Aqua Precision Blue Mirror	Rubberized Matte Black Nylon

* Fits over glasses

BEARKAT® Safety Eye Wear

- Super well thought-out construction combines the best in safety, comfort, and affordability!
- Your vision is unobstructed by the one-piece wraparound lens, which by its tight fit allows you maximum safety
- Comfort is enhanced by the flexible temples and the non-slip temple sleeves are notched for a clip-on breakaway cord!



Item No.	Description
ESGFE4045-C	Clear Lens
ESGFE4045-G	Grey Lens
ESGFE4045-IO	Indoor/Outdoor Clear Mirror Lens

Safety Eye Wear

Klondike® Safety Eye Wear



- Features safety and style at an affordable price to separate you from the pack
- Whether on the slopes or in the workplace, Klondike®'s matte black or blue frame finish, adjustable temples, and soft secure TPR nose pad keeps you at the peak of comfort and style all day long

Item No.	Description
ESGFE4040-C	Matte Black Finish Frame, Clear Lens
ESGFE4040-G	Matte Black Finish Frame, Gray Lens

Law® 2 Safety Eye Wear



- Fashionable wrap-around lens design offers an excellent orbital seal and a higher level of protection from side impacts due to its greater coverage area
- TPR (Thermal Plastic Rubber) temple inserts that enhance grip and comfort are included on all styles

Item No.	Description
ESGFE5275-C	Orange Temple Inserts, Clear Lens
ESGFE5275-G	Black Temple Inserts, Silver Mirror Lens

BlackKat® Safety Eye Wear



- Features a trendy style while being one of the lightest glasses in the industry
- Weighs a remarkable 22 grams
- This dielectric offering includes a brow guard and TPR (Thermoplastic Rubber) nose-piece for additional protection and comfort
- Frame and lens are constructed with virgin polycarbonate

Item No.	Description
ESGFE4090PR-C	Clear Lens
ESGFE4090PR-G	Gray Lens

Frostbite® Safety Eye Wear



- One of the "Coolest" looks in eye wear protection
- Features an oval lens design that creates a great orbital seal for superior eye protection
- Lightweight nylon frame makes this offering a comfortable choice for all day use

Item No.	Description
ESGFE1600-C	Black Frosted Frame, Clear Lens
ESGFE1600-S	Black Frosted Frame, Gray Lens

Checklite® Safety Eye Wear



- Offers our exclusive Duramass® scratch-resistant lens coating and spatula temples
- This light weight option gives you a comfortable feel and each Checklite® exceeds ANSI Z87+

Item No.	Description
ESGFE5000-C	Clear Lens
ESGFE5000-G	Gray Lens
ESGFE5000-M	Blue Mirror Lens

Yukon® Safety Eye Wear



- Features a contemporary wrap-around style
- Provides increased angular coverage and improved peripheral vision
- Molded-in brow guard and vented side shields give additional protection

Item No.	Description
ESGFE5000EA-C	Clear Uncoated Lens

Stratos® Safety Eye Wear

- Features a one piece polycarbonate lens and a stylish wrap-around design that offers the user a wide area of protection
- Integral side shields offer protection from particles entering the eye wear from the sides
- Provides an exceptional wide angle of unrestricted vision allowing you to safely assess your environment
- The molded-in nose bridge comfortably fits a wide variety of faces

Item No.	Description
ESGFE4080PR	Black Frame, Clear Lens
ESGFE4081PR	Black Frame, Gray Lens

Standard Safety Goggles, Direct Vent

- Item No. ESGFE1903EA
- Use this great quality goggle for protection against dust and flying debris in landscaping, agricultural, harvest and general maintenance applications
 - Made from soft, green PVC with a clear polycarbonate lens and elastic headband
 - Fits conveniently over most prescription eye wear
 - Meets ANSI Z87.1 specifications

Standard Safety Goggles, Indirect Vent

- Item No. ESGFE1900EA
- Chemical splash indirect vent, rubber strap clear AF lens
 - Our goggles provide a wide, unobstructed field of vision and can be worn with most half-mask respirators
 - The transparent protective PVC body permits a comfortable fit over prescription eye wear while protecting against impact
 - Goggle straps contain no Latex

Standard Safety Goggles, Non-Vented

- Item No. ESGFE2020EA
- Ventless, rubber strap, clear anti-fog lens
 - Our goggles provide a wide, unobstructed field of vision and can be worn with most half-mask respirators
 - The transparent protective PVC body permits a comfortable fit over prescription eye wear while protecting against impact
 - Goggle straps contain no Latex

Face Shield—Positive Lock Headgear

- Item No. ESGFE2000EA
- This lightweight face shield features an 8"x12"x 0.04" PETG plastic window
 - Positive Lock headgear has two snap-in straps that adjust independently to ensure a tight fit
 - Yellow, high-impact plastic single crown
 - Compliance: EPA 40 CFR 170 for chemical splash eye protection
 - Meets ANSI Z87.1-1989 and CAN/CSA-Z94.3-92

Eye Wear Cleaning Wipes—Box of 100 Wipes

- Item No. ESGFE0001BX
- Keep your safety and prescription glasses, face-shields and computer screens clean with these oversized (5"x 8"), individually packed, premoistened wipes
 - The anti-fog, anti-static, silicone-free formula cuts through sweat, grease, dirt and grime
 - Excellent on glass or polycarbonate lenses
 - Dispenser box can be wall mounted

Fire Classification

- Class A Fires - Ordinary combustibles such as wood, cloth, paper, straw and stalks
- Class B Fires - Flammable liquids, gases and greases
- Class C Fires - Energized electrical fires

ABC Fire Extinguishers

- Specially formulated ammonium phosphate-base dry chemical extinguishers may be effectively used to combat Class A and Class B fires as well as having a Class C listing
- Allows use in the presence of energized electrical equipment
- Designed and engineered to the highest-quality standards
- Meets DOT, Coast Guard and OSHA requirements
- Operating temperature: -65° F to 120° F
- Operating range: 2-1/2 lb. (9 to 15 ft.), 5 lb. (12 to 18 ft.), 10 and 20 lb. (15 to 21 ft.) - minimum distance of 8 ft. is most effective and prevents spreading of burning material
- Discharge time (minimums): 2-1/2 lb. size (10 seconds), 5 lb. size (14 seconds), 10 lb. size (20 seconds) and 20 lb. size (30 seconds)



ESG549973C91 ESG549974C91 ESG549975C91 ESGB504765

Item No.	Description
ESG549973C91	2-1/2 lb. capacity - U/L Rating 1A-10B:C, Includes Vehicle Bracket
ESG549974C91	5 lb. capacity - U/L Rating 2A-10B:C, Includes Vehicle Bracket
ESG549975C91	10 lb. capacity - U/L Rating 4A-10B:C
ESGB504765	20 lb. capacity - U/L Rating 20A-120B:C

Water Fire Extinguisher

- Item No. ESG700709200
- The cooling, soaking and penetrating 30-45 foot stream and 50-second discharge time make it a very effective and inexperienced-operator-friendly extinguisher for use on Class A fires
 - 2-1/2 gallon capacity - U/L Rating 2A
 - Stainless steel stored-pressure extinguisher
 - Operating temperature: 40° F to 120° F
 - Operating range: 45-55 ft.
 - Operating time: 50 seconds

Mounting Brackets

Item No.	Holding Capacity
ESG549978C91	10 lb.
ESG700709201	20 lb. & 2-1/2 gallons

FlexKnee Knee Pads

- Item No. ESGRG2700PR
- Hard surface, nonslip work surfaces and grueling deep knee work requires tough protection
 - Designed with lightweight pads, capped with large abrasion-resistant rubber caps for long-lasting wear
 - The wrap-around rubber cap design and Velcro® closures allow both maximum flexibility and a secure fit

Economy Hi-Vis Lift Belt

- Designed with an 8" elastic back panel, positive Velcro® front panels and 3" wide elastic V-shaped side pulls
- Suspenders and elastic side pulls are bright green (green color goes around entire backside of belt and the green fabric is non-reflective—for daytime visibility only)
- Wide elastic suspenders are detachable

Item No.	Size (Waist)
ESGRG2500EA-S	Small (26"-32")
ESGRG2500EA-M	Medium (32"-38")
ESGRG2500EA-L	Large (38"-47")
ESGRG2500EA-XL	X-Large (47"-56")



Schiek® Lift Belts

- Increase worker compliance with a comfortable lift belt they will want to wear!
- Belt has a conical shape that conforms to the natural shape of the back and the unique hip and rib contour eliminates "ride-up"
- The extra-wide front and back gives you improved back injury protection
- The stainless steel buckle and exclusive "Slide N Grip" Velcro® closure remains secure under the most strenuous use

Item No.	Size (Waist)	Width
ESGRG2600EA-BLK-S	Small (27"-32")	4-3/4"
ESGRG2600EA-BLK-M	Medium (31"-36")	4-3/4"
ESGRG2600EA-BLK-L	Large (35"-41")	4-3/4"
ESGRG2600EA-BLK-XL	X-Large (40"-45")	4-3/4"
ESGRG2600EA-BLK-2XL	XX-Large (44"-50")	4-3/4"
ESGRG2610EA-BLK-S	Small (27"-32")	6"
ESGRG2610EA-BLK-M	Medium (31"-36")	6"
ESGRG2610EA-BLK-L	Large (35"-41")	6"
ESGRG2610EA-BLK-XL	X-Large (40"-45")	6"
ESGRG2610EA-BLK-2XL	XX-Large (44"-50")	6"
ESGRG2610EA-BLK-3XL	XXX-Large (50"-54")	6"



Rain Suit .35mm

- Cape back
- Corduroy collar
- 2 pockets
- 3 vents
- Detachable hood

Item No.	Size
ESGR8900-S	Small
ESGR8900-M	Medium
ESGR8900-L	Large
ESGR8900-XL	X-Large
ESGR8900-2XL	2X-Large
ESGR8900-3XL	3X-Large
ESGR8900-4XL	4X-Large
ESGR8900-5XL	5X-Large
ESGR8900-6XL	6X-Large
ESGR8900-7XL	7X-Large
ESGR8900-8XL	8X-Large

Tyvek® Coveralls

- Collar and full zipper front
- Protection against dust, powders and grease, as well as splash protection from Class III and Class IV pesticides
- EPA 40 CFR 170 compliant



Basic Tyvek® Coveralls

Item No.	Size
ESGBW1920-S	Small
ESGBW1920-M	Medium
ESGBW1920-L	Large
ESGBW1920-XL	X-Large
ESGBW1920-2X	2X-Large
ESGBW1920-3X	3X-Large
ESGBW1920-4X	4X-Large



ESGBW1920H



ESGBW1920HF

Tyvek® Hooded Coveralls with Elastic Wrists & Ankles

- Available with shoe covers (ESGBW1920HF)

Item No.	Size	Shoe Covers
ESGBW1920H-M	Medium	No
ESGBW1920H-L	Large	No
ESGBW1920H-XL	X-Large	No
ESGBW1920H-2X	2X-Large	No
ESGBW1920H-3X	3X-Large	No
ESGBW1920H-4X	4X-Large	No
ESGBW1920HF-M	Medium	Yes
ESGBW1920HF-L	Large	Yes
ESGBW1920HF-XL	X-Large	Yes
ESGBW1920HF-2X	2X-Large	Yes
ESGBW1920HF-3X	3X-Large	Yes
ESGBW1920HF-4X	4X-Large	Yes



Tyvek® Coveralls with Elastic Wrists & Ankles

Item No.	Size
ESGBW1925-S	Small
ESGBW1925-M	Medium
ESGBW1925-L	Large
ESGBW1925-XL	X-Large
ESGBW1925-2X	2X-Large
ESGBW1925-3X	3X-Large
ESGBW1925-4X	4X-Large



Norcross PVC Knee Boots

- 15" safety boot meets ANSI Z41-1999 Section I standards for Impact/75 and Compression/75 toe protection
- Features Safe-Toe steel toe and steel shank, with removable, washable cushion insoles
- Deep angle cleat, anti-skid soles and heel
- Reinforced at critical stress points
- 100% waterproof

Item No.	Shoe Size
ESGFW1205-7	7
ESGFW1205-8	8
ESGFW1205-9	9
ESGFW1205-10	10
ESGFW1205-11	11
ESGFW1205-12	12
ESGFW1205-13	13

Disposable Polypropylene Shoe Covers

Item No. ESGFW1118BAG



- Provides a barrier when mixing, loading or applying hazardous pesticides, solvents or caustic chemicals
- The Tychem® SL fabric is laminated with chemical resistant Saranex® film
- Can be used with Tyvek®, Tychem® QC or Tychem® SL coveralls to help protect feet and prevent contamination of footwear
- Disposable, 17" high, elastic top



Rubber Boot/Shoe Covers

- Provides great protection from pesticides, solvents and salts also recommended for cleaning up hazardous chemical spills as a hazmat boot
- Designed to stretch easily over work shoes or boots
- Waterproof, textured non-slip sole, 12" height 60 mil thick

- Compliance: EPA 40 CFR 170

Item No.	Size (Men's Shoe Size)
ESGFW2100-L	Large (10-11)
ESGFW2100-XL	X-Large (12-13)



50mil Latex Hazmat Boots

- Slip resistant sole

Item No.	Size
ESGB260-M	Medium
ESGB260-L	Large
ESGB260-XL	X-Large
ESGB260-2XL	2X-Large
ESGB260-3XL	3X-Large



V-Gard® Cap Style Hard Hat

- Third party certified by the Safety Equipment Institute (SEI)
- Stocked in standard size (fits 6-1/2 to 8)
- Features 4-point, Fas-Trac® ratchet suspension
- Meets or exceeds the applicable requirements for a Type 1 helmet (top impact) as outlined in ANSI Z89.1 2003, Class E
- Consists of polyethylene shell and suspension that work together as a protection system

Item No.	Color
ESGFE2250S-Y	Yellow
ESGFE2250S-W	White



White Bump Cap

Item No. ESGFE2400EA

- This bump cap features a 4-point adjustable suspension system
- Clearance between the shell and suspension is comfort-designed for maximum air circulation over the wearer's head
- Note: Bump caps do not meet ANSI Z89.1 specifications and are not to be worn for protection from impact of falling or glancing objects



Safety Vest Class 2

- Custom imprinting available for this product
- Constructed from non-woven material
- Breathable mesh vest features 2" 3M reflective tape, an inside pocket, 3 front snap closure and adjustable Velcro sides that accommodate changes in outerwear and for more flexible sizing
- Color: Hi-Vis Lime, Fiberweb brand
- Wash up to 5 times

Item No.	Size
ESGBW0510-S-M	Small/Medium
ESGBW0510-L-XL	Large/X-Large
ESGBW0510-2X-3X	2X-Large/3X-Large



Orange Safety Vest

Item No. ESGBW0515

- This breathable Class 2 mesh safety vest is constructed from stretch polyester
- Fluorescent yellow color with silver reflective strips on front and back provides high visibility
- Zipper front

Safety Apparel



Winter Bomber with Zip Out Fleece Liner

- PU coating
- 3M reflective material
- Removeable sleeves

Item No.	Size
ESGGLO-B1-M	Medium
ESGGLO-B1-L	Large
ESGGLO-B1-XL	X-Large
ESGGLO-B1-2XL	2X-Large
ESGGLO-B1-3XL	3X-Large
ESGGLO-B1-4XL	4X-Large
ESGGLO-B1-5XL	5X-Large



Winter Bomber Inner Fleece Liner

- PU coating
- 3M reflective material
- Removeable sleeves

Item No.	Size
ESGGLO-EB1-M	Medium
ESGGLO-EB1-L	Large
ESGGLO-EB1-XL	X-Large
ESGGLO-EB1-2XL	2X-Large
ESGGLO-EB1-3XL	3X-Large
ESGGLO-EB1-4XL	4X-Large
ESGGLO-EB1-5XL	5X-Large



Frog Wear Jacket

- Class 3
- PU on nylon
- 3M Scotchlite reflective material
- Flame retardant

Item No.	Size
ESGGLO1400-S	Small
ESGGLO1400-M	Medium
ESGGLO1400-L	Large
ESGGLO1400-XL	X-Large
ESGGLO1400-2XL	2X-Large
ESGGLO1400-3XL	3X-Large
ESGGLO1400-4XL	4X-Large
ESGGLO1400-5XL	5X-Large



Frog Wear Bibbed Overalls

- Class E
- 3M Scotchlite reflective material
- PU on nylon
- Flame retardant

Item No.	Size
ESGGLO-1700-S	Small
ESGGLO-1700-M	Medium
ESGGLO-1700-L	Large
ESGGLO-1700-XL	X-Large
ESGGLO-1700-2XL	2X-Large
ESGGLO-1700-3XL	3X-Large
ESGGLO-1700-4XL	4X-Large
ESGGLO-1700-5XL	5X-Large



Surveyor's Style Mesh Vest

- 3M reflective material
- 6 pockets plus inside iPad pocket
- Mic tab on shoulders
- D ring opening

Item No.	Size
ESGGLO-079-M	Medium
ESGGLO-079-L	Large
ESGGLO-079-XL	X-Large
ESGGLO-079-2XL	2X-Large
ESGGLO-079-3XL	3X-Large
ESGGLO-079-4XL	4X-Large
ESGGLO-079-5XL	5X-Large



Surveyor's Style Vest

- Solid front
- Mesh back
- 3M reflective material
- Zipper closure
- 4 front pockets

Item No.	Size
ESGGLO-003-S	Small
ESGGLO-003-M	Medium
ESGGLO-003-L	Large
ESGGLO-003-XL	X-Large
ESGGLO-003-2XL	2X-Large
ESGGLO-003-3XL	3X-Large
ESGGLO-003-4XL	4X-Large
ESGGLO-003-5XL	5X-Large

Safety Apparel & Accessories



Mesh Vest

- Silver glass bead reflective material
- Zipper closure
- 2 inside pockets

Item No.	Size
ESGGLO-002-S	Small
ESGGLO-002-M	Medium
ESGGLO-002-L	Large
ESGGLO-002-XL	X-Large
ESGGLO-002-2XL	2X-Large
ESGGLO-002-3XL	3X-Large
ESGGLO-002-4XL	4X-Large
ESGGLO-002-5XL	5X-Large
ESGGLO-002-6XL	6X-Large

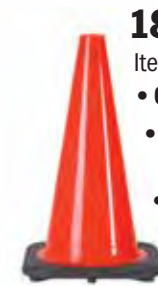

18" Traffic Cone

Item No. ESG8888

- Custom imprinting available for this product
- 18" Orange PVC Traffic Cone with black base is made PVC for superior durability and superior flexibility
- Cone features a UV inhibitors to prevent fading
- Meets MUTCD standards and are NCHRP-350 certified



28" Cone with 6" Upper 4" Lower Reflective Collars

Item No. ESG03-500-10

- All vinyl construction assures durability and flexibility in all weather conditions
- Ultraviolet stabilized color provides maximum resistance to fading
- High density, black base creates low center of gravity for maximum stabilization

28" Rack N Pop Collapsible Cone

Item No. ESG03-501-02

- 28" orange cone
- Waterproof nylon construction assures durability and flexibility in all weather conditions
- Collapses to 2" height and stores in easy-to-carry portable bag



Cone Bar Barricade Kit

Item No. ESG03-824-CBKT

- 2 delineators
- 2 cone bars
- 2 10 lb. weights



Retractable Cone Bar

Item No. ESG03-824CB

- Lightweight at approx. 2 lbs.
- Exterior grade PVC with UV withstands temperature extremes and sunlight

- Traffic cone orange with three 4" high intensity collars
- Extremely reflective at night
- Easily Extends From 5' to 8'
- Unique push pin locking mechanism
- Can create an Instant square barrier system from 5' x 5' or up to 8' x 8' in seconds



Flared 45" Easy Grab Delineator Post

Item No. ESG03-734

- 45" with 2 each 3" high collars
- Post only



Delineator Base

Item No. ESG03-730

- 14" wide x 3" high, 10 lbs.
- Includes 5" diameter center hole

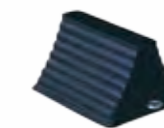

Heavy Duty Wheel Chock

Item No. ESG2048WC

- Fluted design causes downward pressure to lock chock into place
- Metal o hook imbedded in back
- Depth: 8"



6' Parking Block

Item No. ESG2050PB

- 14" Painted Spike ESG2053S sold separately



6' Speed Bump

Item No. ESG2055SB

- 14" Painted Spike ESG2053S sold separately

Safety Accessories



Plastic Stop/Slow Paddles

- Item No. ESG03-823P
- Color: red/orange
 - Pole mounted paddle
 - Includes 18" handle



Vinyl Flag 18" with 24" Wooden Dowel

- Item No. ESG03-229-3417
- Handheld warning flag
 - Heavy duty vinyl material
 - Available in red on orange color
 - Measures 18" x 18"



18" Bright Red Vinyl Flag with 24" Wooden Dowel

- Item No. ESG03-229-3424
- Handheld warning flag



Slow Moving Vehicle Signs & Mounting Hardware

- ASAE (S276.6) approved and State of Illinois compliant
- 14"H x 16"W
- Made with high-intensity, micro-prismatic reflective and fluorescent materials
- Complete, easy to install hardware kit for mounting SMV signs (ESG3040—sold separately)

ESG3040

Item No.	Material	Thickness
ESG3010	Aluminum	.04"
ESG3020	Plastic	.80"
ESG3030	Adhesive	

Item No.	Description
ESG3040	Mounting Hardware Kit



Blood Borne Pathogens Protection Kit

- Item No. ESGKT3060EA
- Designed for cleanup and disposal of potentially dangerous blood spills
 - Contains a spill cleanup pack and a one-person BBP apparel pack

- Packed in weatherproof plastic case with inner gasket
- Cleanup pack contains: 2 oz bottle absorbent powder, scoop, spatula, disinfectant cloth, biohazard bags, Nitrile gloves, antiseptic towelettes.
- Apparel pack contains: control gown, eye shield, face mask, Nitrile exam gloves, biohazard bag and antiseptic towelettes



Oily Waste Can with Hand-Operated Cover

- Used for rags and cloths soaked with solvents, thinners, linseed oil, combustible adhesives and other flammable liquids present a serious fire risk when improperly discarded
- Round construction and elevated base allow circulation of air around can to disperse heat and reduce moisture build-up and rusting
- Lid opens to no more than 60 degrees and stays closed when not in use, isolating contents from fire sources and limiting oxygen to virtually eliminate the risk of spontaneous combustion
- Durable steel construction with a powder-coat finish provides chemical resistance
- Ten-year warranty

Item No.	Capacity
ESG9100	6 Gallon
ESG9300	10 Gallon



Paint Markers

- Each 3-pack contains a yellow, white and black marker
- Ideal for all surfaces such as metal, steel, glass, wood, rubber, plastic & more
- Fast drying and weather resistant marks
- Paint formulated for industrial use
- Replaceable nibs and clip cap for pockets

Item No.	Desc.
ESG4134	Fiber Tip
ESG2294	Metal Tip

Sqwincher® 1.26 oz. Qwik Serv™ Instant Powder Concentrate

- Electrolyte packet drink
- Yields 16.9 ounces (8 packs per bag)
- Pouches are perfect for people who want to keep it simple
- Just pour the portable powder into a ½ liter bottle of water whenever you get the urge

Item No.	Flavor
ESG060904-GR	Grape
ESG060900-OR	Orange
ESG060901-FP	Fruit Punch
ESG060902-LL	Lemon Lime

Hearing Protection



Pura-Fit Foam Earplugs

- Bright green color for easy compliance checks
- Available in uncorded or corded versions
- Earplugs have a longer, tapered shape for easy insertion and removal in any size ear canal
- Smooth, non-irritating surface provides a comfortable and effective fit
- Noise Reduction Rating: 33 dB

Item No.	Desc.
ESGEP2026BX	Corded
ESGEP2025BX	Uncorded



Moldex Rocket® Reusable Earplugs

- The easy grip handle lets these earplugs slip easily into the ear and the unique air bubble design in the tip provides cushioned comfort for all-day wear
- Each pair comes with a convenient Pocket-Pak® carrying case
- Box of 50 (packed 50 uncorded pair or 50 corded pair per box)
- Noise Reduction Rating: 26 dB.

Item No.	Desc.
ESGEP6405BX	Corded
ESGEP6400BX	Uncorded

Contra Band Earplugs

- Item No. ESGEP6710EA
- Super soft ear tips conform to the ear canal for optimal fit and maximum comfort
 - Band has molded finger grips and is angled to fit perfectly every time you put it on
 - Designed to wear with band under the chin
 - Meets CSA Class BL
 - Noise Reduction Rating: 22 dB
 - Made in USA



Elvex® ValuMuff™ Earmuffs

- Item No. ESGEP1500EA
- Noise Reduction Rating of 25 dB
 - Soft pliable SuperSeal cushions
 - Adjusted flexible side clips
 - Meets ANSI Standard S3.19, 1974



Elvex® Blue Foam Earplugs

- Item No. ESGEP6310
- Tapered shape and moderately slow expansion rate of these plugs make them easy to insert
 - Designed to fit all ear canals
 - Packaged 200 individually bagged uncorded pair per dispenser box
 - Noise Reduction Rating: 29 dB



Elvex® MaxiMuff™ Earmuffs

- Item No. ESGEP1600EA
- High-performance earmuff features soft SuperSeal ear cushions
 - Noise Reduction Rating of 28 dB
 - Meets ANSI Standard S3.19, 1974



Tasco Sound Star Earmuffs

- Item No. ESGEP2350EA
- Low-profile earmuffs feature a four point pressure distribution combined with Soft-Seal ear cushions for a super comfortable fit with very little squeeze
 - Durable spring stainless steel headbands
 - Noise Reduction Rating of 25 dB
 - Meets CSA Class A



Moldex Jazz Band® Hearing Protector

- Item No. ESGEP6506EA
- Banded earplugs are a cooler, lighter alternative to earmuffs and do not interfere with eye wear
 - Noise Reduction Rating: 22 dB
 - Includes spare replacement pair of ear pods



Deciguard AB Foam Earplugs

- PVC foam earplugs are formulated with antimicrobial protection that does not wear off, extending the life of the plugs
- New higher density foam provides greater wearer protection and comfort
- Packed 200 uncorded pair per dispenser box, or 100 corded pair per dispenser box
- Both styles individually bagged
- Noise Reduction Rating: 33 dB

Item No.	Desc.
ESGEP2005BX	Corded
ESGEP2004BX	Uncorded

Welding Apparel



Welding Helmet, Solar Powered Auto Darkening

Item No. ESG41260

- Protects against UV and infrared radiation in variable shades from DIN 9 to DIN 13
- Lens automatically darkens when an arc is struck and returns to normal when welding stops
- Powered by solar cells with battery back-up



Welding Helmet, Auto Darkening

Item No. ESG41254

- Durable, lightweight material is corrosion resistant and flame retardant
- Protects against UV and infrared radiation
- Automatic shut-off saves batteries
- Complies with DIN, ISO EN379 and ANSI Z87.1 standard
- 3.5" x 1.5" viewing area



Welding Helmet, Wide-View Solar Power

- Protects against UV and infrared radiation in variable shades from DIN 9 to DIN 13
- Lens automatically darkens when an arc is struck and returns to normal when welding stops
- Powered by solar cells with battery back-up

Item No.	Design
ESG41265	Eagle/Flag
ESG41266	Flame



Clear Protective Replacement Lens

- Clear cover safety welding lenses
- Works with ESG41260
- Protect shaded lens from spatter and debris
- Includes both inner and outer lens

Item No.	Viewing Area	Fits Helmets
ESG41264	4" x 2.125"	ESG41265, ESG41266
ESG41261	4" x 2"	ESG41260



Welding Apparel



Pearl Gray 14" Shoulder Split Cowhide Welders Gloves

Item No. ESG64057602

- Cotton sock lined welders gloves
- With wing thumb
- Affordable standard shoulder split cowhide



Suede Cowhide Welders Gloves

Item No. ESG1919LB

- Welder/fireplace gloves
- Partially welted seams
- Sock lining



Premium Suede Cowhide Welders Gloves

Item No. ESG1914LB

- Welder/fireplace gloves
- Partially welted seams
- Sock lining



Large Bourbon Brown 14" Select Shoulder Split Cowhide

Item No. ESG64057632

- Cotton lined welders gloves
- Reinforced, straight thumb
- Tightest and densest structure



Leather Apron Bib with 2 Chest Pockets

- Bourbon brown side split leather bib apron with two chest pockets
- Cotton crossed back straps and side release buckles

Item No.	Size
ESG64055142	24" x 42"
ESG64055143	24" x 48"

Welding



Lever Action Heavy Duty Grease Gun

Item No. ESG42702

- 6" extension with heavy duty 4 jaw coupler
- Aluminum die cast head
- Variable stroke
- Use with 14 oz. (400 gms) cartridge
- Air bleeder valve
- Grease loader valve
- Develops 10,000 PSI



Air Operated Continuous Flow

Item No. ESG43305

- Includes 6" steel extension and coupler
- Bulk loader valve
- Heavy duty aluminum die cast head
- Use 14 oz. cartridge or bulk fill
- 1/4" NPT air inlet
- Develops 4,800 PSI



Pistol Grip Grease Gun

Item No. ESG43052 Grease Gun Only

- Heavy duty aluminum die cast head with air bleeder
- Comfortable one-hand operation
- Heavy duty pistol handle with rubber grip
- Develops 5,000 PSI
- 3-way loading (14 oz. cartridge, suction and hand fill or with filler pump)
- **Item no. ESG43052A Includes 18" flexible hose extension and 4-jaw coupler**



Deluxe Mini Pistol Grip Grease Gun

Item No. ESG43252

- One hand pistol grip grease gun
- Convenient pull type operating mechanism
- Works with 3 oz. grease cartridge
- Up to 1,500 PSI



19.2V Cordless Battery Grease Gun

Item No. ESG47220 Grease Gun Kit includes 1 Rechargeable Battery
Item No. ESG47221 Grease Gun Kit includes 2 Rechargeable Batteries

- Powerful 19.2V high torque motor
- Pressure release valve prevents gun from damage due to excessive back pressure
 - Up to 6,000 PSI (413 bar) output grease pressure
 - Grease output up to 3 oz. (85 grams) per minute in free flow
- Automatic air bleeder and bulk loader
- Grease Gun Kit includes:
 - Durable molded case
 - One "one hour quick charge" battery charger
 - 30" (762 mm) high pressure hose with spring guard on both ends (prevents hose kinking)
 - High pressure grease coupler



Item No.	Replacement Accessories
ESG47256	30" Replacement Hose
ESG47258	Rechargeable Battery , 19.2V , 1.5 Ah, Lithium Ion
ESG47251	1 Hour Battery Charger (Lithium Ion), 110V /60 Hz, 19.2V, US Plug

Grease Gun Air Release Valve

Item No. ESG44838

- Spare bleeder fitting for grease guns
- Manual version
- Vents air pockets in grease guns efficiently
- Zinc plated finish



Grease Joint Rejuvenator

Item No. ESG7862

- Includes 5" flex hose for hard-to-reach areas
- Unclog frozen grease joints



- Works on all types of equipment for farming, excavating, construction and industrial equipment, aircraft, automobiles, trailers and more



Pocket Grease Joint Rejuvenator

Item No. ESG7864

- Produces 2-1/2 times more pressure than the larger Grease Joint Rejuvenator (ESG7862)
- Smaller and lighter but works in the same way as the kit model (ESG7862)

4-Way "Easy Out" Grease Tool

Small Item No. ESG44890
Large Item No. ESG44891



- Dual purpose for removing worn & broken grease fittings
- Re-tapping holes for installing new grease fittings
- Works with straight & angled fittings
- Available in small & large sizes for use on almost all threaded fittings

4-Jaw Coupler

- 1/8" NPT
- Hardened coupler body
- Hexagonal nut for easy tightening



ESG43512
Narrow Profile

ESG43502
Standard Duty

ESG43522
Heavy Duty

Item No.	Working Pressure
ESG43512	3,000 PSI
ESG43502	6,000 PSI
ESG43522	10,000 PSI

Heavy Duty 3-Jaw Coupler

Item No. ESG43525

- Use with air operated grease guns
- Hardened coupler body with double wall thickness withstands high pressure without deformation
- Fully hardened spring steel jaws
- Hexagonal nut for easy tightening
- 10,000 PSI



90° Heavy Duty Coupler

Item No. ESG43552



- Designed to work at any 90° angle
- Locks coupler in place for straight applications
- Polyurethane seal for optimal fit inside coupler when contact with grease fitting is made
- Working pressure up to 1,000 PSI

Lubrication Accessories

Heavy Duty Grease Gun Holder

Item No. ESG44842



- Secures most battery-operated grease guns
- Mount as needed with 1/4" carriage bolts (not included)
- Rugged holder firmly secures standard size tube-style grease guns

Grease Gun Holder

Item No. ESG44840



- Perfect for safe and convenient storage of grease gun
- Simple snap action design
- Zinc plated finish
- Durable heavy gauge steel sheet construction
- Mounts on almost any surface

Flexible Grease Hose

- Highly flexible, durable thermoplastic construction
- Flexible hose extension for hard-to-reach places
- Fitted with 4-jaw professional coupler
- Minimum radius bend of 1.57"
- Hose ID: 0.14" / OD: 0.33"
- Hydraulic crimped zinc plated connectors



Item No.	Length	Working Pressure	Spring Guard
ESG43624	12"	3,500 PSI	No
ESG43625	18"	3,500 PSI	No
ESG43680	12"	3,500 PSI	Yes
ESG43681	18"	3,500 PSI	Yes
ESG43721	12"	5,800 PSI	No
ESG43722	18"	5,800 PSI	No
ESG43780	12"	5,800 PSI	Yes
ESG43781	18"	5,800 PSI	Yes



Grease Injector Needle with Cap

Item No. ESG44880

- 1-1/2" long, 18 gauge
- Designed for very tight spaces such as sealed bearings and universal joints
- Comes complete with protective plastic holder
- Equipped with standard grease fitting without back check



Quick Connect Narrow Needle Nose

Item No. ESG44861

- Used for dispensing a fine line of grease
- Needle design allows operator to contact flush or hard to reach hydraulic type fittings in inaccessible areas
- Can be attached directly to steel extensions or flexible hoses
- Ideal for sealed bearings and u joints



Steel Extension

- Straight adapter
- 1/8" NPT

Item No.	Style
ESG44822	4" Straight
ESG44829	6" Straight
ESG44802	6" Bent

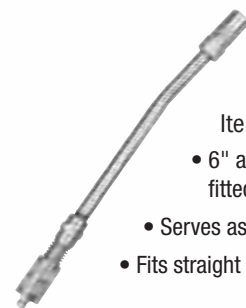

Coupler to Coupler Button Head Extension

Item No. ESG44907

- 6" angled delivery tube and 4 jaw professional coupler fitted onto the quick disconnect adapter
- Serves as an extra length extension on grease guns
- Fits straight onto the grease gun coupler

Regular Coupler to Right Angled Coupler

Item No. ESG44908



- For hand operated grease gun
- Fitted onto the quick disconnect adapter
- Quickly converting regular couplers for grease fittings with limited access, in low height areas etc.
- Fits straight onto the grease gun coupler
- 1,000 PSI

Lubrication Accessories

Jaw Type Coupler to Seal Off Dispenser

Item No. ESG44909



- Seal Off Dispenser fitted onto quick disconnect adapter
- For quickly converting regular couplers for lubricating automobiles with grease plugs etc.
- Fits straight onto the grease gun coupler

12" Quick Connect Hose

Item No. ESG44910

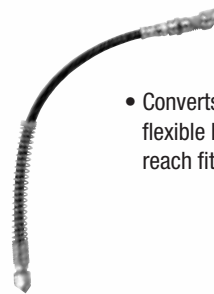

- Converts steel extension coupler assembly on grease guns to a flexible hose and allows the gun to be used for greasing hard to reach fittings

360° Heavy Duty Swivel Coupler

Item No. ESG44911



- 45° angle gives easy access to most grease fittings
- 1/8" NPT female inlet
- Jaws are fully hardened for extended service life
- Spring loaded ball check valve helps retain pressure
- Metal seal for increased resistance to wear
- Working pressure up to 6,000 PSI

Hydraulic 360° 3-Jaw Coupler

Item No. ESG43562



- For hand operated grease guns
- Excellent for effective lubrication of difficult & hard to reach grease fittings
- Jaws are fully hardened for extended service life
- Hardened body & swivel joints withstand high-pressure applications without deformation
- Zinc plated finish
- Spring loaded ball check valve helps retain pressure
- 7,000 PSI

Professional Narrow Needle Nose Adapter

Item No. ESG44920



- Designed for greasing flush or hard-to-reach hydraulic type fittings in inaccessible areas

Recessed Lube Adapter

Item No. ESG44921



- For push on greasing of recessed fittings where obstructions would not permit the use of a regular hydraulic coupler

Professional 90° Angled Lube Adapter

Item No. ESG44922



- For hand operated grease guns
- For greasing inaccessible grease fittings in shoulders and other confined areas
- 1,000 PSI

7 Piece Quick Connect Grease Accessory Kit

Item No. ESG44950



- Includes: Professional recessed lube adapter with quick disconnect, whip hose with heavy duty coupler and quick connect, jaw type coupler, narrow needle nose adapter, 90° angle adapter/right angle adapter, regular coupler to right angled coupler and stainless steel 1-1/2" grease injector needle
- Tough, oil resistant nylon pouch

Grease Fittings

Grease Fittings



Grease Fitting
Straight



Grease Fitting
Angled 45°



Grease Fitting
Angled 90°

SAE Grease Fittings

Item No.	1/8" - 27 Pipe Threads PTF	Hex Size
ESG46035	Straight Short	7/16"
ESG46041	45°	7/16"
ESG46042	65°	7/16"
ESG46044	90°	7/16"
Item No.	1/4" - 28 SAE-LT - Taper Threads	Hex Size
ESG46000	Straight	5/16"
ESG46003	45°	3/8"
ESG46006	90°	3/8"
Item No.	1/4" - 18 Pipe Threads NPT	Hex Size
ESG46020	Straight	9/16"

Metric Grease Fittings

Item No.	M6 x 1	Hex Size
ESG46200	Straight	9.0
ESG46201	45°	9.0
ESG46202	90°	9.0
Item No.	M8 x 1	Hex Size
ESG46220	Straight	9.0
ESG46222	45°	9.0
ESG46223	90°	9.0
Item No.	M10 x 1	Hex Size
ESG46230	Straight	11.0
ESG46231	45°	11.0
ESG46232	90°	11.0

* All makes Grease Fittings Selection, not meant for direct replacement of OE specified grease fittings



100 Piece SAE Grease Fitting Assortments

Item No. ESG44710

- Ball check
- Heat-treated greasing end and springs
- Premium quality

Threads	Straight	Straight Long	45°	90°
1/4" 28 SAE-LT	25	5	10	10
1/8" 27 SAE-PTF	30	-	10	10



60 Piece Metric Grease Fitting Assortments

Item No. ESG43983

- Ball check
- Heat-treated greasing end and springs
- Premium quality

Threads	Straight	45°	90°
M6 x 1	10	10	10
M8 x 1	5	5	5
M10 x 1	5	5	5



80 Piece Grease Fitting Assortments

SAE Item No. ESG43972
Metric Item No. ESG43973

- Manufactured to the most stringent quality standards
- Fittings with ball check use heat treated springs for increased life
- Stainless steel

"Drive Fit" Grease Fitting Installer

Straight Item No. ESG44892
Angled Item No. ESG44893



- For installing straight & angled Drive-Fit grease fittings into untapped holes
- Steel construction in zinc plated finish

Filter Wrenches



Large Filter Wrench Pliers

Item No. ESG29100

- Full range pliers ideal for removing canister style filters from agriculture and construction equipment and vehicles
- Jaw range of 4-1/4" to 7" and 17" overall length
- Rubber grip handles provide leverage and extra reach
- Better grip and grabbing power with serrated teeth
- Heavy duty forged construction

Truck Filter Wrench

Item No. ESG28100



- Use with 1/2" square drive
- Fits small diameter filters from 4-1/8" to 4-21/32"
- Wide 1-1/2" steel band designed to withstand the high torque requirements of truck, bus, RV and heavy duty equipment filters



Gator Jaws

Item No. ESG7899

- Removes any canister-type oil, hydraulic and fuel filter safely around hot engines and those hard-to-reach areas
- 23" long reach for overtightened, hard-to-reach filters
- Perfect for all vehicles from light trucks and autos to heavy machinery
- Works on 1-1/2" to 8" diameter filters



Oil Filter Wrench

- Cushion grip vinyl handle
- Wide dimpled band securely grips filters without crushing
- Features a swivel handle which allows users to get to filters in hard-to-reach areas

Item No.	Size	Filter Diameter
ESG24300BLK	Small	2-13/16" to 3-5/32"
ESG24100BLK	Medium	3-1/2" to 3-7/8"
ESG23900BLK	Truck/Tractor	4-3/4" to 5-1/8"



Nylon Strap Oil Filter Wrench

Item No. ESG27900

- Use with 1/2" square drive
- Strong nylon web belt will not slip
- Adjusts quickly to any spin-on filter up to 6" in diameter





Lube Oil Dispenser Pump

Item No. ESGGF44150

- Lever action dispenser pump
- Includes 48" hose with nozzle
- Fits on standard five gallon pail



Grease Filler Pump

Item No. ESGGF44212

- Follower plate and female loading fitting included
- Clamps to standard five gallon pail
- Fast, positive refilling with simple pump action

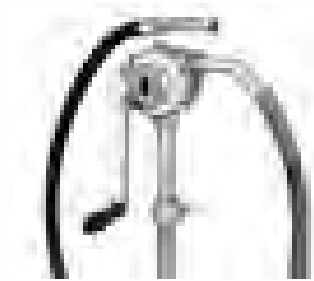

3:1 Manual Rotary Geared Pump

Item No. ESG44198

- Geared Rotary barrel pump with 3 times discharge per rotation. For every complete handle turn, the rotor turns 3 times
- Die Cast Aluminum construction with sintered gear driven die cast zinc rotor & vanes

- Discharge through 6 ft (1.8 m) of delivery hose with metal nozzle
- Complete with a 3 pc threaded suction tube for use on 15 gallons (50 litre) to 55 gallons (205 litre) barrels
- Delivers 55 gallon / 205 litres in 3 minutes.

Quart Stroke Pump

Item No. ESG44187

- Pump has a built in 2" Bung Adapter and comes complete with a telescopic suction tube for use with 15 gallons (50 litre) to 55 gallons (205 litre) barrels.
- Other design features include:
 - Spring Loaded Drain Back Tube for overflow media
 - Lockable handle which allows the pump to be pad locked when not in use
 - Lock Nut for positioning the pump outlet in any direction



Lever Action Barrel Pump

- Aluminum die cast pump head
- Fits 15 to 55 gallon drum sizes
- Dispenses 10 oz. of fluid per stroke

- Rugged steel pump body and ribbed section
- Convenient 1-1/2" and 2" bung
- Comfort grip rubber handle

Item No.	Description
ESG44100	NBR Seals
ESG44120	Viton Seals
ESG44125	Lever Action Barrel Pump, Viton Seals plus Non-drip Cover



Diaphragm Fuel Transfer Pump

Item No. ESG44195

- Heavy Duty Fuel Transfer pump with discharge up to 1 gallon per 5 strokes (800 ml / stroke)
- Ideal for use where compressed air / power is not easily available such as farms / ranches, construction sites, boat etc.

- Stainless Steel Piston & fuel resistant hi-nitrile rubber diaphragm
- Includes a 2" die cast bung adapter and extra heavy duty steel handle with security locking latch
- For use with 15 gal. (50 litre) - 55 gal. (205 litre) drums



Lever Action Barrel pump for use with Bio Diesel & E85 Fuels

Item No. ESG44109

- An extremely rugged and strong all steel pump designed specifically for use with Diesel & E85 fuels
- Constructed from select materials which are compatible with Bio Diesel & E85 fuels

- Fracture proof design with steel pump head and bung
- Extra long pump body makes it easy to place refill containers on the drum for convenient filling
- Complete with telescopic suction tube for use on 15 gallon and 55 gallon barrels

Heavy Duty Electric Fuel Pumps

- Industrial grade high flow designed for heavy duty usage



- Rain and weather proof for tough outdoor usage
- Precision sintered metal gear design
- Non-corroding aluminum die cast construction is lightweight yet strong

- Geared construction is tolerant to contaminants in fuel, with maximum suction
- cUL, ATEX & IECEx listed motor, duty cycle: 30 mins. on / 30 mins. off

Item No.	Volts	GPM
ESG44040	12V DC	15
ESG44041	24V DC	15
ESG44042	115V AC	13
ESG44045	12V DC	20



Rotary Chemical Pump

Item No. ESG44191

- Designed for use with media with which a regular cast iron or steel barrel pump cannot be used
- Pump body is made from glass filled polypropylene with Ryton veins

- All seals are from Viton and all pump hardware is Stainless Steel
- Strainer fitted at the suction tube inlet stops contaminants from entering the pump
- Complete with threaded polypropylene suction tube and a choice of two 2" bung adapters for use on both plastic & metal drums of capacity 15 gallons (50 litre) to 55 gallons (205 litre)

Battery Operated Siphon Pump

Item No. ESG44410

- Battery operated pump for quick & convenient transfer of Diesel, Kerosene, Light oils & water based media
- Ideal for transferring small quantities of media into boats, garages & small shops
- Delivers: up to 1.8 GPM
- Suitable for use on 5 gallon containers
- Self Priming pump—works on a battery operated 3V DC motor
- Hang hole provided at top allows pump to be conveniently stored when not in use
- Works on 2 "D" size (LR20) Alkaline Batteries (not included with the pump). Approx. working life with one set of batteries is 396 gallons
- Complete with 23-1/2" long flexible corrugated discharge hose
- Total length: 24.6"
- Suction tube length: 14.8"



Heavy Duty Electric Oil Pumps

- Designed specifically to transfer bulk oils, hydraulic fluid and antifreeze

- Air cooled motor with thermal protection
- Non-corroding aluminum die cast construction is lightweight yet strong
- Precision sintered metal gear design

- High horsepower to flow ratio assures adequate power to pump viscous fluids at low temperatures
- Self-priming, positive displacement design
- Features internal bypass valve to bypass flow

Item No.	Volts	GPM
ESG45550	115V AC	4.4
ESG45555	115V AC	9.0

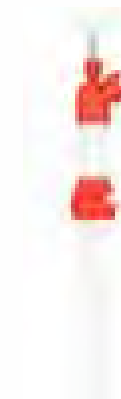

Nylon Chemical Pump

- Self priming Vertical Lift Pump designed primarily for use with lacquer thinners, Urea, AdBlue, DEF etc.
- Nylon construction with stainless steel plunger rod & PTFE seals
- Complete with 2" polypropylene bung adapter

Item No.	Description
ESG44193	For use with 55 gal (205 Litre) Drums
ESG44186	For use with 25 Litre Drums

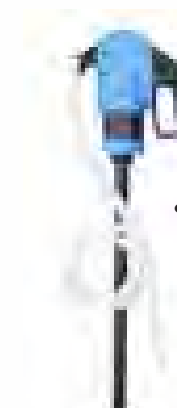

Lubricant Pump, DEF, Antifreeze, Chemical Pump

Item No. ESG44185

- Lever Action Barrel pump, designed for use with high viscosity oils, agricultural chemicals etc.
- Pump design makes it extremely convenient and comfortable to pump thick oils without excessive fatigue
- Built-In 2" Bung Adapter allows the pump to be fixed on Drums with 2" Opening
- Supplied complete with suction tube for use with 15-55 gal. (50-205 Litre) drums and 2m x 3/4" Flexible Corrugated discharge hose

Rotary Barrel Pump



- Our most popular Rotary Pump is loaded with features such as Dual Directional Operation which allows the pump to both empty, as well as refill containers
- Extremely heavy duty & rugged weighing 14.5 lbs.
- Pump body is sturdy cast iron with precisely machined cast iron vanes for better draw & smoother delivery
- Fits 15 gallons to 55 gallons barrels
- Comes complete with suction tube, 2" cast iron bung nut & discharge spout
- For dispensing Diesel, Kerosene, Heating Oils, Motor Oils, Lubricating Oils (up to SAE 90), and other non-corrosive media

Item No.	Description
ESG44000	NBR Seals, 3/4" Inlet, Steel Discharge Spout, Telescopic Suction Tube
ESG44050	NBR Seals, 1" Inlet, Steel Discharge Spout, Telescopic Suction Tube
ESG44030	Professional Manual Rotary pump with steel spout, NBR Seals
ESG44031	Professional Manual Rotary pump with steel spout, NBR Seals, Rubber Hose
ESG44032	Professional Manual Rotary pump with steel spout, Viton Seals

Electric Diesel and Oil Pump

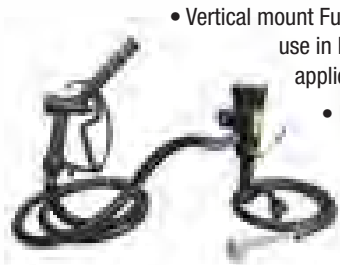

- Vertical mount Fuel and Oil pump designed for Indoor use in Industrial, Automotive, Heating, and Marine applications
- For use with non-flammable media
- Pumps have built in Bung Adapter to fit directly onto drums with a 2" threaded opening
- Manufactured from chemically inert materials these pumps work with a wide variety of low viscosity media
- Pump motor has double insulation which makes them safe for use with water and emulsions
- Built-In Anti Siphoning system ensures that media does not flow out by Siphon action in case of accidental damage to the delivery hose or dispensing nozzle
- Duty Cycle: Continuous Duty
- Includes Hose, Manual Fuel Control Nozzle and 6-1/2 ft. (2m) Electrical Cable

Item No.	Volts	GPM
ESG45522	110V AC	10.5

Industrial Rotary Fuel Pump with Steel Discharge Spout



- Industry Standard for Rotary pumps, these are by far the heaviest duty, for severe outdoor use in extreme weather conditions
- Deliver media with a head lift up to 20 ft.
- Solid cast iron construction, fully CNC machined to close tolerances
- Pump Handle rotates a high quality sintered powder metal 3 Vane Rotor inside a highly finished pumping chamber
- Self Priming operation with discharge up to 38 LPM (10 GPM)
- Supplied complete with 2" Bung, Telescopic Suction Tube with Strainer for use with 15 gallons (50 litre) and 55 gallons (205 litre) barrels

- Also available - Pump with Mechanical Fuel Meter in both litre and gallon versions

Item No.	Description
ESG44080	Steel Discharge Spout
ESG44083	Drip Pan for use with pump

Air Operated Grease Pump



- Item No. ESG45415
- Dispenses grease at pressures up to 50 times the air inlet pressure
 - Ideal for use in industry, workshop, farm, construction or as part of the mobile grease system
 - Fitted with strainer at suction tube inlet for clean grease to the bearing
 - Working pressure 30 to 150 PSI

Battery Operated Drum Pump



- Item No. ESG45503
- Rechargeable battery operated
 - 12V DC Power Cable included
 - For pumping fuels, water based media, light oils, DEF & select chemicals from metal drums of 55 gallon or 275-330 gallon IBC's
 - Stainless steel filter built into the suction tube inlet prevents contaminants from getting in & causing damage
 - Telescopic suction tube extends from 33-1/2" to 49"
 - 6.6' hose & manual dispensing nozzle with 3/4" OD stainless steel spout
 - Delivers up to 4.86 GPM

High-Flow Fuel Nozzle With Digital Fuel Meter



- Item No. ESG9048
- Integrated digital flow meter and fuel nozzle
 - Select gallons, liters, quarts or pints
 - 1" NPT inlet
 - Non-locking type
 - Works with common diesel, gasoline, kerosene
 - Use with any barrel-type or standard fuel transfer pump

Fuel Control Nozzle



- For use with electric fuel pumps
- Built-in sensor automatically shuts off supply
- Heavy duty cast aluminum body and trigger, vinyl grip

Item No.	Mode	Swivel
ESG45590	Manual	Yes
ESG45591	Manual	Yes
ESG45570	Automatic	No
ESG45571	Automatic	No

Mechanical Fuel Meters



- Durable die cast aluminum construction
- Nutating disc mechanism offers high tolerance to fuel contamination
- Works with either fuels or oils
- Three port design allows meter to be fitted in-line or with inlet and outlet ports at right angle

Item No.	NPT	Unit
ESG45681	3/4"	Litres
ESG45682	3/4"	Gallons
ESG45684	1"	Litres
ESG45685	1"	Gallons

Digital Fuel Meter



- Item No. ESG45651
- Digital turbine meter for low viscosity fluids
 - Easy to install in-line or for end of line
 - Measures in liters, quarts, pints, gallons
 - Aluminum body and sealed electronic card, ideal for use in severe weather conditions
- Display can be rotated in four different positions

Manual Fuel Control Nozzle Fitted with Digital Fuel Meter



- Nozzle with die cast aluminum construction with built in Swivel at inlet and switch for unattended continuous dispensing
- Polyamide turbine measuring mechanism
- Electronic display using two AAA 1.5V batteries
- Aluminum meter body and sealed electronic card makes it suitable for use in severe weather conditions
- Measures in litres, quarts, pints, or gallons
- Easy user recalibration

Item No.	NPT
ESG45661	Threaded 3/4"
ESG45666	Threaded 1"

Mechanical Diesel Meter



- High Accuracy Diesel Meter with mechanical register
- Nutating disc mechanism offers high tolerance to fuel contamination
- Meter is designed for both In-Line applications & gravity flow (with a minimum gravity head of 4')
- Ideal for use with electric fuel pumps
- Register cap can be easily removed & rotated to every 90° orientation for display reading
- Robust aluminum die cast construction
- Easy user re calibration
- Works with both fuels and oils

Item No.	NPT	Unit
ESG45642	1"	Litres
ESG45641	1"	Gallons

Fuel Pump Parts



Fuel Filter with 10 micron Filter Element

- High Flow Fuel filter, complete with 10 micron fuel filter element
- The 10 micron paper filter element filters even small particles of rust, scale, grit, dirt, sand, and lint at a gravity flow of 19 litres / minute (5 GPM) with only a 24" (600 mm) head. The filter element has 366 square inches of filtering surface which results in more particle retention, which means cleaner fuel, and fewer costly engine repairs.



Replacement Filter Element—10 Micron

Item No. ESG44395



Replacement Water Block Filter Element—10 Micron

Item No. ESG44397



Replacement Rubber Hose

Item No. ESG44338

- For Rotary Barrel Pumps (RBP)



Replacement Fuel Hose—Anti Static, 12' Long

Item No.	ID	NPT (M)
ESG44077	3/4"	3/4"
ESG44078	1"	1"



Service Kit for RBP Pumps

Item No. ESG44086

Item No.	Description
ESG44391	1" NPT
ESG44393	1" NPT with water block filter element



Spin On Cartridge Style Fuel Filter with 10 micron Filter

- High Flow Fuel Filter, complete with 10 micron Spin-On style filter cartridge
- Inlet and Outlet threaded 1" (F)
- Fits spin on cartridges with 1-1/2"- 16 UNF threads
- Also available water block fuel filter element which separates water from fuel

- Replacement Spin-On Filter cartridges available as spare

Item No.	Description
ESG45901	1" NPT
ESG45903	1" NPT Water Block



Fuel Filter Wrench, Opens 4439x Series Filter Bowls

Item No. ESG44394

- Easy to use Filter Wrench for removing Filter Bowl when changing Filter element

- Weather Resistant reinforced Nylon construction will not damage the bowl like metal oil filter wrenches
- Wire through hole provided for attaching to fuel tank



Reed Valves for Fuel Transfer Pumps

Item No. ESG44194

- Replacement reed valves for ESG44195 Diaphragm Fuel Transfer Pump

Funnels & Drip Pans



Standard Screen Funnels

- Spout length reduces over-pouring and spillage
- Outer ribbing design eliminates air lock
- In-spout safety screen reduces contamination
- Ideal for agriculture and industry

Item No.	Capacity	Top ID	Spout ID	Height
ESG32091	1 Pint	4-1/2"	1/2"	6"
ESG32002	2 Quart	6-1/2"	1-1/16"	8-1/2"
ESG32006	6 Quart	8-1/2"	1-5/16"	10-1/2"

Capped Funnels

- Color-coded system for identification of fluids used with each funnel
- Durable polyethylene construction
- Ideal for agriculture and construction industry
- Cap prevents funnel from collecting engine grime, dirt and other contaminants
- Promotes a clean workshop and fights contamination
- Unique design prevents leftover fluid from dripping out

Item No.	Capacity	Top ID	Spout ID	Height
ESG32105	1 Pint	3"	1/2"	9-1/2"
ESG32115	1.25 Quart	4"	5/8"	10-1/2"
ESG32130	1.5 Quart	4"	5/8"	17"
ESG32140	1.5 Quart	4"	1-1/8"	13-1/4"



4 Quart Drum Funnel with Safety Screen

Item No. ESG32900

- Overall height: 4-3/8"
- Top ID: 11-3/4"
- 2" thread

- Spout length: 1-1/2"
- Spout OD: 2-1/2"



3 Quart Drum Funnel with 2" Threads

Item No. ESG32400

- Overall height of 9-3/16"
- Top ID: 7-1/2"
- Spout length: 1-7/16"

- Spout OD: 2-1/4"
- 2" thread, max temp 250° F



Pour Spout

Item No. ESG32177-7

- For use with quart, 1 gallon & 5 gallons
- Chemically-resistant clear tube keeps contents visible
- Comes with adapter for Reike threaded nozzle
- Flexible spout ideal for hard-to-reach areas
- Eliminate unwanted drips with the included cap



Oil Drip Tray

Item No. ESG40092

- 22" x 22" x 1-1/2"
- Chemically-resistant polypropylene
- Three gallon capacity



4 Gallon Oil Drain Pan

Item No. ESG32953

- Overall height: 5-1/2"
- Top ID: 17-3/4"

- 1" diameter pour spout built into the pan



Diamond Grip Terminal Cleaners

Item No. ESG8040

- For flat and spade style terminals

- Works on both male and female connectors
- Removes corrosion and extends harness life
- Reduces diagnostic guesswork by eliminating bad connections
- Three piece set: small, medium and large
- Includes leather-type holster

Super Hard Diamond-Coated Round Micro Files

Item No. ESG8042

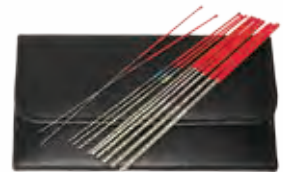

- Cleans Cannon, Deutsch, Bullet and other round terminals along with general filing applications
- Also for use in general filing applications such as steel, aluminum, plastic, brass, etc.
- Individual sizes are marked and available for replacements

- Includes leather-type holster



Terminal Connector Cleaners Master Kit

Item No. ESG8025

- Cleans/resizes 4/5 flat connectors, 6-way round and 7-way flat (spade) pin terminals

- For male and female connections
- For tail and side marker light assemblies

- Maintains continuity and prevents circuit failure



7 Round Pin Connector Cleaners

Item No. ESG8024

- Clean and resize male and female tractor trailer connectors

- Remove corrosion from connectors
- Enhance electrical contact points

- Extend harness life
- Use as a pin wear gauge

- Includes 7 Round Pin Cleaners (2)



15mm 9mm 6mm

Diamond-Coated Electrical Contact Cleaners

Item No. ESG8047

- Three-piece set covers wide range of contact sizes
- Super hard, diamond coating is highly abrasive and durable
- Enhances connections and extends contact life
- Non-slip, high-viz, ergonomic handles for comfortable use
- Ultra-thin, flexible files for added functionality
- Includes 6mm, 9mm and 15mm

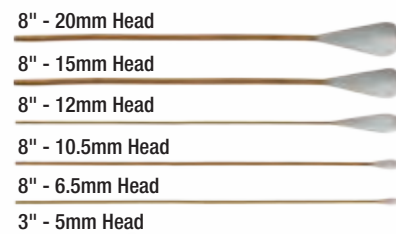

8" - 20mm Head
8" - 15mm Head
8" - 12mm Head
8" - 10.5mm Head
8" - 6.5mm Head
3" - 5mm Head

Swab-EEZ®

Item No. ESG9010

- 325 piece set of industrial grade swabs
- For the removal of dirt and the precise application of shop chemicals

- Lubricate, clean and paint: bores, fittings, head bolt holes, tubing, threads, gaskets, grease, guns, pipes, dirt and debris and much more

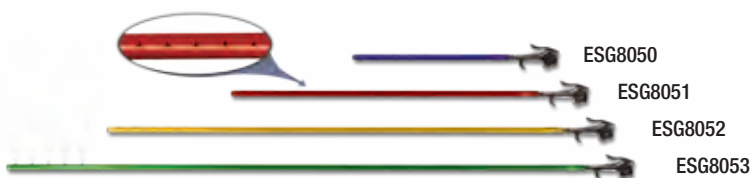

Air Comb® Engine & Radiator Cleaner

Item No.	Length
ESG8050	12"
ESG8051	24"
ESG8052	36"
ESG8053	48"

- Thoroughly cleans engines, condensers and radiators from the inside out
- Focused high pressure output
- Accesses hard-to-reach areas
- Unique design—won't punch holes like conventional blow guns



4/5 Pin Towing Maintenance Kit

Item No. ESG8026

- Quickly tests, cleans and repairs truck and trailer 4/5 pin connectors
- Works on both male and female connectors
- Extends harness life
- Great preventative maintenance tool
- Promotes safety and limits road hazards

- Includes 4/5 Pin Trailer Harness Checker, 4/5 Pin Cleaner, 2 mL DeoxIT® Cleaner



6 Round Pin Towing Maintenance Kit

Item No. ESG8027

- Quickly tests, cleans and repairs truck and trailer 6-way round pin connectors
- Works on both male and female connectors
- Extends harness life
- Great preventative maintenance tool
- Promotes safety and limits road hazards
- Includes 6 Pin Round Pin Tester, 6-way Round Connector Cleaners, 2 mL DeoxIT® Cleaner



7 Flat (Spade) Pin Towing Maintenance Kit

Item No. ESG8028

- Quickly tests, cleans and repairs truck and trailer 7-way flat pin connectors
- Works on both male and female connectors
- Extends harness life
- Great preventative maintenance tool
- Promotes safety and limits road hazards
- Includes 7 Spade Pin Circuit Tester, Connector Cleaners, 2 mL DeoxIT® Cleaner



7 Round Pin Towing Maintenance Kit

Item No. ESG8029

- Tests tractor electrical circuits
- Enhances electrical contact points
- Removes corrosion from truck and trailer connectors
- Extends harness life
- Use as a pin wear gauge

- Includes 7 Round Pin Tractor Trailer Circuit Tester, 7 Round Pin Cleaner, 2 mL DeoxIT® Cleaner



3-Way Trailer Adapter

Item No. ESG8000

- Allows 7-way flat (spade) pin type terminal connections to 6-way round pin and 4/5 pin trailer connections

- Made from strong Nylon 6

- Sealed plugs to keep road debris from corroding connections
- 'Winged' grip for easy installation and removal



36 Piece Bore Brush Set

Item No. ESG8001D

- 36 Brushes: 12 steel, 12 brass, and 12 nylon

- 8mm – 19mm diameter with 1/4" hex shank

- 1/4" locking bit head driver included

- Twisted wires for increased cleaning function
- For use in automotive, AG / industrial and MRO industries



6 Piece Twisted Stainless Steel Wire Brush Assortment

Item No. ESG8080

- Features the most common sizes: 8, 10, 12, 15, 17 and 19mm
- 1/4" hex shank

Wiper Blades

14" Dyna ISO (Double-Flat Shaft) Radial Dry Wiper Arm

Item No. ESG201558

Crosses To:

- JE 52174
- Anco 49-14R (Black)
- Anco 45-23 (Silver)

AutoTex Heavy Duty Stainless Steel Narrow Saddle Wiper Blade

- Heavy duty applications
- Stainless steel flat windshield wiper blade
- Designed specifically for flat windshields
- DuraTex all-natural compression molded rubber
- Fits 5mm & 6.4mm saddles



5mm & 6mm Narrow Saddle

Crosses to:

- Anco 51 Series
 - Trico 61 Series
- Note: Has the adapter and hardware necessary for both the Anco and Trico Narrow Saddle applications

Item No.	Length
ESG71-12	12"
ESG71-14	14"
ESG71-16	16"

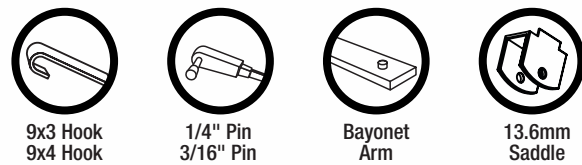

16" Dyna OEM Universal Wiper Blade

Item No. ESG13416

- Premium performance blade
- Exclusive aerodynamic frame to prevent wind lift
- All metal, triple coated, anti-corrosion steel frame
- Steel riveted pin joints to strengthen frame
- Tested for over 1 million cycles

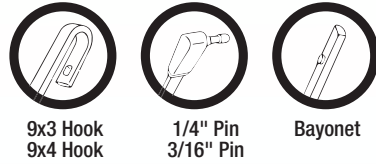

AutoTex M6Pro Premium Conventional Metal Wiper Blade

Item No. ESGM6-24

- Pre-installed connector fits 9x3 hooks arms. Included adapter fits 9x4 hook, 1/4" and 3/16" pin, and bayonet wiper arms
- Tested to last up to 1.5 million cycles
- Galvanized, anti-corrosion, heavy-gauged steel frame is 20% thicker than traditional conventional wiper blades
- DuraTex® Pro Compression-molded, 100% natural rubber
- Primary frame's cross section is asymmetric to enable better wind-lift performance

Crosses to:

- Anco 91 Series
- Bosch Micro Edge Excel
- RainX Weatherbeater
- Michelin High Performance



24" AutoTex Heavy Duty 13.6mm Saddle Wiper Blade

Item No. ESG78-24

- Fits 13.6mm saddle arms
- Designed for a wide range of vehicles from truck, to bus, to RV, and many other specialty vehicles
- DuraTex all-natural compression molded rubber

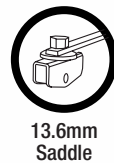

13.6mm Saddle

Crosses to:

- Anco 50 Series*
- Trico 67 (e.g. 67-281)
- Trico 68**

* Anco does not fit 17mm saddles

** Trico does not come with hardware for 17mm

Power Supply & Battery Solutions



POD-X1: Power Supply & Jump Starter

Item No. ESGBOX1KIT

- 200 normal-400 peak
- 20 jump starts in one charge (used on 4 cylinder vehicles)
- One charge from jump starter will last 6 to 12 months without use
- 5V USB port for charging cell phones, iPads, MP3 players, cameras, tablets, GPS units, PSP and more
- High power 3 function LED flashlight with strobe, flashlight & S.O.S flash patterns
- Includes: USB 1 to 4 charging cable, Apple lightning, Apple 30 Pin, Micro USB, Mini USB, 100-240 vac charger & 15V DC car charger



LED POD (Power On Demand) X5 Auto/Truck Jump Starter & Power Supply

Item No. ESGBOX5KIT

- 400 normal – 800 peak
- Jump Start Port for jump starting gasoline & diesel engines
- Up to 20 jump starts in one charge for gasoline engines, 5 for diesel engines
- 5V USB port for charging cell phones, MP3 players, tablets, cameras, GPS units, PSPs and more
- 12V, 16V & 19V for charging laptops and other electronics
- High power LED flashlight with 3 functions: flashlight, strobe & coast guard approved S.O.S
- One charge from jump starter will last 6 to 12 months without use
- Includes: 1 home charger, 1 car charger, 2 adapter cables, 1 jumper cable w/ clamps & 8 notebook connections

CELL MAX™ Alkaline Batteries



- CELL MAX Alkaline batteries are built to readily start up high drain devices with dynamic instantaneous power
- These Batteries are a great general use Battery for your everyday power needs

Item No.	Description
ESGCM-6LF22-BP1	9 Volt 1 Pack
ESGCM-LR6-BP2	9 Volt 1 Pack
ESGCM-LR6-BP4	AA 4 Pack
ESGCM-LR6-PBH24	AA 24 Pack
ESGCM-LR03-BP2	AAA 2 Pack
ESGCM-LR03-BP4	AAA 4 Pack
ESGCM-LR03-PBH24	AAA 24 Pack
ESGCM-LR14-BP2	C 2 Pack
ESGCM-LR20-BP2	D 2 Pack



CELL MAX™ Digital Alkaline Batteries

- CELL MAX Digital Alkaline batteries offer the maximum capacity from a single use battery
- They are developed using the latest advanced technology, providing up to 6 times longer lasting power than ordinary Zinc batteries

Item No.	Description
ESGCM-LR6-BP4DG	AA 4 Pack
ESGCM-LR03-BP4DG	AAA 4 Pack



Battery Doc® 2/4/8 Amp 12 Volt Smart Charger

Item No. ESG20085

- LED indicates the selected charging rate (2, 4 or 8 amps)
- Water resistant enclosure with coating to protect circuit board
- Universal AC input, 100-140 VAC, 60 Hz
- 6' AC cable and 8' DC cable included
- Includes alligator clips and ring terminal harness for multiple applications



Battery Doc® 2/8/16 Amp 12 Volt Smart Charger

Item No. ESG20087

- LED indicates the selected charging rate (2, 8 or 16 amps)
- IP30 rated enclosure designed with louver for ventilation

- Water resistant enclosure with coating to protect circuit board
- Universal AC input, 100-140 VAC, 60 Hz
- 6' AC cable and 8' DC cable included
- Includes alligator clips and ring terminal harness for multiple applications



Battery Doc® 12 Volt 10 Amp Solar Controller

Item No. ESG23122

- Maintains and regulates 12 volt batteries from overcharging and discharging
- Includes digital volt meter display
- Handles up to 10 amps (120 watts) of array current
- Maintenance free protection of your solar panel and batteries

- Maintains 12 volt batteries in a fully charged state
- Small, compact and easy to mount
- For use with gel-cell, AGM, deep cycle and all lead-acid 12 volt batteries
- Easily mounted in weather protected area



Battery Doc® 6/12 Volt 900 mA Automatic Battery Charger/Maintainer

Item No. ESG20025

- 3 LED displays indicate charge status at a glance
- 12' output cable lead
- Includes alligator clips and ring terminals with fuse

- Toggle switch to select voltage on rear panel



Mini Master Battery Disconnect Switches

ESG20387

- For application up to 48 volts DC and can be in either a two or four position
- ISO 8846 approved
- Continuous rating: 300 amps
- Intermittent rating: 1000 amps/5 seconds
- Crank rating: 700 amps/10 seconds
- Can be used with one or two batteries
- Dimensions: 2.5" x 2.5" x 3" high
- Surface or panel mount
- Includes four mounting holes for easy access

Item No.	Style
ESG20387	Single Battery - On/Off Knob & Bottom Cover
ESG20393	Dual Battery - Off/1/Both/2 Knob & Bottom Cover



Compact Battery Switch: Top Mount

Item No. ESG20308

- Easy-to-install on negative battery post
- Battery is disconnected by unscrewing the knob a few turns and reconnected by tightening the knob
- Knob can be removed completely to deter theft
- Compact size fits most battery compartments
- Includes battery terminal markers
- Rated 500 amps surge and 125 amps continuous at 12 volts



Water-Resistant Master Switch Kit: Includes 2 Keys & Waterproof Cover

Item No. ESG20314

- Excellent for marine or automotive use
- Rated 100 amps continuous, 1000 amps surge, at 12 volts
- Rated below 50 amps continuous, 500 amps surge, at 24 volts
- 2-1/4" diameter x 2-1/2" deep (1-1/4" deep behind panel)
- Two 3/16" diameter mounting holes



Battery Isolator: Lever Operated Switch

Item No. ESG20304

- Master battery isolator disconnect switch
- 100 amps continuous at 12 volts



Knife Blade Battery Switch: Side Terminal

Item No. ESG20128

- For side terminal batteries
- Mounts on negative side battery terminal
- 3-1/4" W x 3-3/4" L x 1-1/2" H
- Provides 3/8-18 bolt for receiving standard eyelet cable connector



Knife Blade Battery Switch: Top Post

Item No. ESG20138

- For top post batteries, low vertical operation
- Switches recommended to mount on negative battery post to disconnect ground and battery
- Easy to reach and operate
- 3" W x 4" L x 2" H
- 5/8" diameter post for receiving standard battery cable clamp



Knife Blade: Top Post with Stud

Item No. ESG20148

- For top post batteries, low vertical operation
- Switches recommended to mount on negative battery post to disconnect ground and battery
- Easy to reach and operate
- 3" W x 4" L x 2-1/4" H
- 5/8" diameter post, plus 5/16-18 stud and wing nut for extra connections



Knife Blade Battery Switch: In-Line Eye To Eye

Item No. ESG20188

- Surface mounted "in-line"/remote mount switches
- For concealed installations or where battery box space is limited. One side connects to the battery cable; other side connects to the vehicle cable
- 3" W x 4" L x 2" H
- Both terminals are 5/16" bolts for receiving eyelet cable connectors

Battery Doc® 4-in-1 Adapter

Item No. ESG23129



- Safely connects up to four like solar panels in parallel
- 11' 6" long
- Includes four bullet EZ connectors
- Quick and easy to use—no cutting or splicing!

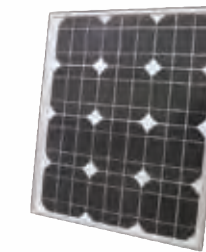

Battery Doc® Solar Charger Heavy Duty 30W Panel

Item No. ESG23130

- Monocrystalline panels are a highly efficient solution for converting sunlight to electricity
- Ideal for situations with limited space
- Corrosion resistant anodized frame
- Dimensions: 21" L x 16" W x 1" D



Battery Doc® Solar Trickle Charger/Maintainer 5W Panel Kit

Item No. ESG23143

- Anodized aluminum weather resistant frame
- Dimensions: 12-1/2" W x 12-1/2" L x 1" D
- Amp Rating: up to 420 mA
- Accessories included:
 - 12V male output adapter (cigarette lighter adapter)
 - Alligator clips
 - Voltage tester
 - Mounting hardware (screws)



Battery Doc® Solar Charger 9W Panel Kit

Item No. ESG23144

- Anodized aluminum weather resistant frame
- Dimensions: 8.3" W x 24.4" L x 1" D
- Amp Rating: up to 750 mA
- Accessories included:
 - 12V male output adapter (cigarette lighter adapter)
 - Alligator clips
 - Voltage tester
 - Mounting hardware (screws)
 - 10' solar panel lead wire

Tie Downs

Ratchet Tie Downs

- Super comfortable, thermo-plastic rubber handles are molded onto frames on select models
- Weather and corrosion resistant hardware finished with zinc and nickel plating, or powder coating
- PVC-coated hooks on standard duty ratchet series that will not scratch
- Cut and abrasion resistant webbing is woven from high tensile strength polyester—performs better than nylon
- Engineered stitching for system strength and durability

ESG310800

ESG310001

ESG310081



Heavy-Duty Ratchet Tie Downs

Item No.	Description	Break Strength	Work Load
ESG310800	40' x 2", JJ Hook, Bar Handle	10,000 lbs.	3,300 lbs.
ESG310001	27' x 2", JJ Hook, Bar Handle, *Step Release	10,000 lbs.	3,300 lbs.
ESG310081	27' x 2", Flat Hook, Bar Handle, *Step Release	10,000 lbs.	3,300 lbs.

* Step Release ratchets allow you to release tension slowly and safely, one click at a time.

ESG325600

ESG318420

ESG312600

ESG350701



Standard-Duty Ratchet Tie Downs

Item No.	Description	Break Strength	Work Load
ESG312600	16' x 1", S Hook, Small Bar Handle	1,500 lbs.	500 lbs.
ESG318420	6' x 1", S Hook, Small Bar Handle (Twin Pack)	1,800 lbs.	600 lbs.
ESG325600	16' x 1-1/4", JJ Hook, Sure Grip Handle	2,500 lbs.	830 lbs.
ESG350701	16' x 1-1/2", JJ Hook, Sure Grip Handle	5,000 lbs.	1,665 lbs.

Replacement Straps



ESG05344

- Zinc hooks
- Cut and abrasion resistant webbing is woven from high tensile strength polyester
- Engineered stitching for system strength and durability

Item No.	Description	Break Strength	Work Load
ESG05344	30' x 2" Replacement Strap, Flat Hook	10,000 lbs.	3,333 lbs.
ESG05354	30' x 2" Replacement Strap, JJ Hooks	10,000 lbs.	3,333 lbs.
ESG320881	25' x 4" Replacement Strap, JJ Hooks	20,000 lbs.	6,660 lbs.

Truck Tie Downs



- Zinc plated flat hook or delta ring
- Yellow polyester webbing

Item No.	Description	Break Strength	Work Load
ESG03603	30' x 4" Truck Tie Down, Flat Hook, Poly Bag	15,000 lbs.	5,000 lbs.
ESG04603	30' x 4" Truck Tie Down, Delta Ring, Poly Bag	18,000 lbs.	6,000 lbs.

Standard Winch Bar



Item No. ESG05304

- Black finish
- Knurled grip
- Break strength: 5,000 lbs.

Standard Weld-On 4" Winch



Item No. ESG05314

- Black powder coated finish
- 0.9" drive hole
- Break strength: 15,000 lbs.

Tie Downs

Portable Bolt-On 4" Winch



Item No. ESG05324

- Black powder coated finish
- 0.9" drive hole
- Bolts included
- Break strength: 12,000 lbs.

2" Mini Winch



Item No. ESG05334

- Bolt-on or weld
- Powder coated frame
- Zinc plated hardware
- 1/2" drive hole
- Cut case
- Break strength: 10,000 lbs.

Recovery Straps



ESG151520

- Constructed of strong, lightweight, polyester flat webbing
- Reinforced loops that extend the service life
- Engineered, stitch tested to the rated capacities with an added safety margin

Item No.	Description	Break Strength
ESG151520	20' x 2" Recovery Strap with loops	15,000 lbs.
ESG152020	20' x 2" Recovery Strap with loops	20,000 lbs.
ESG152030	30' x 2" Recovery Strap with loops	20,000 lbs.
ESG06502	20' x 3" Heavy Duty Recovery Strap with loops	27,000 lbs.
ESG06602	30' x 3" Heavy Duty Recovery Strap with loops	27,000 lbs.
ESG153630	30' x 4" Heavy Duty Recovery Strap with loops, Poly Bag	36,000 lbs.
ESG156030	30' x 6" Heavy Duty Recovery Strap with loops, Bulk	54,000 lbs.

Tow Ropes



ESG112400

- Braided with high quality nylon and have steel forged hooks
- They offer very low elongation nylon
- Constructed with double braided nylon and are oil and abrasion resistant
- Come with either steel forged hooks or braided loops

Item No.	Description	Break Strength
ESG112400	17' x 3/4" Diameter, Braid-On-Braid Rope with hooks	15,000 lbs.
ESG112401	17' x 3/4" Diameter, Braid-On-Braid Rope with loops	15,000 lbs.

Heavy-Duty Tarp Straps

- Available in sizes from 9" to 41"
- 24" and 36" tarp straps feature patented molded holes for adjustable length
- Weather-resistant natural rubber
- Strong and durable zinc coated S-hooks
- Versatile strap with high elasticity holding power



Heavy-Duty Adjustable

Heavy-Duty Standard

Item No.	Length
ESG710900	9"
ESG711500	15"
ESG712100	21"
ESG712400	24" Adjustable
ESG713100	31"
ESG713600	36" Adjustable
ESG714100	41"

Tarp Strap S-Hooks



Item No. ESG710040

- Four pack replacement hooks
- 5mm S-hooks for tarp straps and adjustable tarp straps
- Strong and durable zinc coated finish

Lift Equipment

Air Bottle Jacks



ESG18222C

- Effortless air operation will greatly reduce operator fatigue and speed up the efficiency of garage work
- Versatile "Quick Connector" design provides for easy removal of air hose from air motor allowing compact storage or remote operation
- All air bottle jacks have chrome plated rams

• A compact yet powerful Air Turbo Motor U.S. Patent No. 5,341,723 is equipped to raise the load to the desired height efficiently, effortlessly, and safely U.S. Patent No. 5,946,912, a built-in bypass device protects hydraulic system from over pumping damage

Item No.	Capacity	Lifting Range
ESG18122C	12 Ton	9-1/2" to 18-1/2"
ESG18204C	20 Ton	9-3/4" to 18-3/4"

Manual Bottle Jacks

- Easiest accessible pumping system eliminates off-center pumping force for the most efficient operation
- Extra large base provides added stability and strength



ESG10200

- Serrated heat-treated saddle provides generous lifting area and secure grip
- Unique cross-type forged release valve assures positive control
- A wide, rugged base provides stability and strength
- Heat-treated extension screw allows low pick-up height adjustment and maximum lift height
- U.S. Patented built-in bypass device protects hydraulic system from over-pumping damage
- Critical stress points are reinforced in all models for added durability and dependability

Item No.	Capacity	Lifting Range
*ESG10080	8 Ton	9-1/2" to 18-1/2"
ESG10120	12 Ton	9-1/2" to 18-5/8"
ESG10128	12 Ton	6" to 10-3/4"
ESG10200	20 Ton	9-1/2" to 18-5/8"
ESG10208	20 Ton	6-1/2" to 11-1/4"

* Product color is red

Ratchet Style Jack Stands



ESG32125

- Sturdy, welded steel construction for superior safety and strength
- One piece, multi-position ductile ratchet bar provides super strength and durability, and quick adjustment mechanism that securely locks into desired location
- Counter-weighted pawl serves as a safe, secure locking device to prevent the load from accidentally disengaging

Item No.	Capacity	Support Range
ESG32035	3 Ton	11-1/2" to 17"
ESG32065	6 Ton	15-3/8" to 24-3/8"
ESG32125	12 Ton	17-1/2" to 27-1/2"

Pin Style Jack Stands



ESG32105B

- Sturdy, welded steel construction for superior safety and strength
- Heavy gauge, steel frame helps prevent distortion or twisting

Item No.	Capacity	Support Range
ESG32105B	10 Ton	18-5/8" to 30-1/2"
ESG32107	10 Ton	28" to 47"
ESG32225	22 Ton	13-1/3" to 19-2/3"

Lift Equipment

Long Chassis Service Jacks



ESG25107

- Innovative design of Turbo Lift offers a quicker lift for professional performance
- U.S. Patented built-in bypass device protects hydraulic system from over pumping damage
- Metered release system allows for precise load control
- After the first pump reaches the lifting point, the jack continues with extraordinary lifting speed to raise the load to the desired height

Item No.	Capacity	Lifting Range
ESG25057	5 Ton	6-1/2" to 22-1/4"
ESG25107	10 Ton	6-7/8" to 27"

20 Ton Hydraulic Air/Manual Service Jack



- Effortless air operation will greatly reduce operator fatigue and speed up the efficiency of garage work
- A compact yet powerful Air Turbo Motor U.S. Patent No. 5-341-723 is equipped to raise the load to the desired height efficiently, effortlessly, and safely U.S. Patent No.5-946-912, a built-in by-pass device protects hydraulic system from over pumping damage
- Versatile "Quick Connector" design provides for easy removal of air hose from air motor allowing compact storage or remote operation
- All air bottle jacks have chrome plated rams

Item No.	Capacity	Lifting Range
ESG22203	20 Ton	13" to 39-5/8"

Truck Jack



- Quick rated capacity lift using air-actuated operation
- User friendly, self-returning spring minimizes operators effort, greatly reducing fatigue
- Inline air filter traps contaminants and protects air motor for longer life
- Chrome plated rams
- U.S. patented built-in bypass device protects hydraulic system from over pumping damage

Item No.	Capacity	Lifting Range
ESG23221	22 Ton	9-3/4" to 23-5/8"

1.5 Ton Floor Style Transmission Jack



- The adjustable head can be tilted forward, backward and side to side for optimum alignment of transmission bolt patterns and pins
- Hydraulic system is protected from internal damage by a patented bypass mechanism
- Rugged steel wheels and full swivel ball bearing casters
- U.S. Patented built-in by-pass device protects hydraulic system from overpumping damage
- Multi-adjustment knobs ensure that transmission cradle is always at the right angle to position and accept any load
- Load-restraining chain is vital for raising and lowering safety
- Four wheel casters allow easy movement, positioning of transmission jack

Item No.	Capacity	Lifting Range
ESG43000	1.5 Ton	7-7/8" to 37-1/4"

Service Jack Combo



- Magic Lift technology
- Built in hydraulic bypass
- Steel frame construction for added strength
- Wide solid stance for extra stability
- Packed in one box for easy storage and delivery

Item No.	Capacity	Service Jack Lifting Range	Jack Stands Support Range
ESG25032	3 Ton	6-1/2" to 22-1/4"	11-1/2" to 17"

Lift Equipment



Air/Hydraulic Bottle Jacks

- Effortless air operation will greatly reduce operator fatigue and speed up the efficiency of garage work
- Versatile "Quick Connector" design provides for easy removal of air hose from air motor allowing compact storage or remote operation

- A compact yet powerful Air Turbo Motor U.S. Patent No. 5,341,723 is equipped to raise the load to the desired height efficiently, effortlessly, and safely U.S. Patent No.5,946,912, a built-in by-pass device protects hydraulic system from over pumping damage
- All air bottle jacks have chrome plated rams

Item No.	Capacity	Lifting Range
ESG18502	50 Ton	10-7/16" to 16-3/4"
ESG18992	100 Ton	17-3/4" to 51-1/2"
ESG18302C	30 Ton	11" to 18-1/8"



10 Ton Air Jack/Support Stand

- Operates as both a support stand and air actuated jack
- Completely air operated and has a heavy duty pin locking system
- Comes with a 10 foot air hose and maneuverable wheel base for easy accurate positioning

Item No.	Capacity	Lifting Range
ESG34100	10 Ton	17-1/2" to 51"



3 Ton Engine Crane

- Installation and removal of engines, radiators, differentials, gas tanks, etc.
- Roller bearings in wheels for ease of movement
- Swivel hook for full rotation of load
 - Side swivel of boom for ease of positioning load
- Pry bar to remove weight from leg to ease movement of leg extension
- 3 boom extension position

Item No.	Capacity	Lifting Range
ESGHW93806	3 Ton	30-1/2" to 120-1/2"



Hydraulic Bottle Jacks

- Easiest accessible pumping system eliminates off-center pumping force for the most efficient operation
- Extra large base provides added stability and strength
- Serrated heat-treated saddle provides generous lifting area and secure grip
- Heat-treated extension screw allows low pick-up height adjustment and maximum lift height
- U.S. Patented built-in by-pass device protects hydraulic system from overpumping damage

- Unique cross-type forged release valve assures positive control
- A wide, rugged base provides stability and strength
- Critical stress points are reinforced in all models for added durability and dependability
- Easiest accessible pumping system eliminates off-center pumping force for the most efficient operation

Item No.	Capacity	Lifting Range
ESG10500	50 Ton	9-1/2" to 13-7/8"
ESG10300	30 Ton	11" to 18"

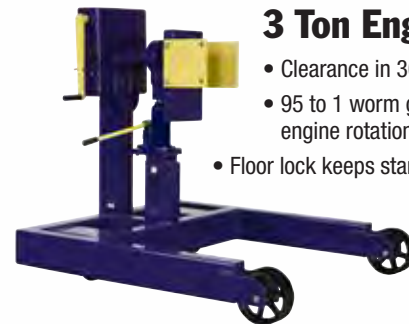

3 Ton Engine Stand

- Clearance in 360 degree rotation
- 95 to 1 worm gear drive and long handle provides easy engine rotation
- Floor lock keeps stand from moving during repairs
- Universal adapter included
- Used with optional adapters

Item No.	Capacity	Lifting Range
ESGHW93776	3 Ton	37-1/2" to 43-1/4"



3 Ton Load Leveler

- Item No. ESGHW93805
- Designed to handle and position components
 - The horizontal tilt can be adjusted to compensate for off-center loads
 - Used to angle a component when necessary to install
 - Extension arms allow it to be compatible with a wide variety of engines

Lift Equipment



100 Ton Shop Press

Item No. ESGHW93610

- 100 ton capacity
- Heavy steel welded construction
- Includes hand wench for easy bed adjustments
- Excellent for bending, bonding or straightening applications
- 1 HP / 2 gallon electric pump
- Quiet operation meets OSHA regulations
- Industrial hard chrome plated ram helps prevent rust and corrosion
- Ideal for the removal or installation of gears, universal joints, pulleys, wrist pins, and other press jobs



100 Ton Shop Press Guard

Item No. ESGHW93625

- 84" tall x 43.13" wide guard made with 1.5 x 3" thick aluminum extrusion with a (7) position
- Vertical sliding window with 1/2" black PVC coated mesh screen

10 Ton Body Repair Kit with Case

Item No. ESG50100

- A must for body collision repair use
- Designed for applications of pushing, spreading and pressing of vehicle body panels as well as various component parts and assemblies
- A variety of attachments are included



- Pumps are rated from 8,000 to 10,000 PSI
- Perfect-fit attachments use quick-connect technology for effortless assembly
- Sets are portable for easy usage in shop or on the road
- Custom fitted, rugged blow-molded storage case and it has wheels for easy movement

• U.S. Patent NO. 5,520,400

4 Ton Body Repair Kit with Case

Item No. ESG50040

- A must for body collision repair use
- Designed for applications of pushing, spreading and pressing of vehicle body panels as well as various component parts and assemblies



- A variety of attachments are included
- Pumps are rated from 8,000 to 10,000 PSI
- Perfect-fit attachments use quick-connect technology for effortless assembly
- Sets are portable for easy usage in shop or on the road
- Custom fitted, rugged blow-molded storage case
- U.S. Patent NO. 5,520,400



Brake & Parts Cleaner

Item No. ESG6201548

- Fast drying cleaner safely removes dust and grease from brake parts and other metal objects
- Eliminates brake squealing and contains no chlorinated solvents
- VOC compliant
- An extension tube is provided for accurate spraying in any position



Glass Cleaner

Item No. ESG20020

- Powerful streak-free glass cleaner that contains ammonia and works on a variety of surfaces
- Cuts through grease, is non-abrasive, and does not leave a film
- Works well in commercial or industrial applications



Multi-Purpose Cleaner/Degreaser

Item No. ESG6201568

- Heavy duty cleaner quickly removes grease and oil, strips wax, and cleans without leaving a residue
- Environmentally formulated and does not contain caustic acids or chlorinated solvents
- Safe to use on most surfaces
- VOC compliant in all states except for California and Utah



Chain & Cable Lube

Item No. ESG6201502

- Lightweight black lubricant that penetrates deeply and prolongs the life of any size chain or wire by keeping it supple and resisting rust
- Displaces water and has excellent clinging properties
- Extension tube is provided for pinpoint application
- Application should be confined to light duty drive chains not running thru an oil bath



Super Strength Penetrating Oil

Item No. ESG6201543

- Lightweight penetrant that releases rusted, corroded or frozen assemblies
- This fast acting formulation includes penetrants, lubricants, and corrosion inhibitors and leaves an anti-rust film for continued protection
- Sprays in any direction and an extension tube is provided for pinpoint application



Electric Motor/Contact Cleaner

Item No. ESG6201526

- Quick acting contact cleaner that penetrates to dissolve grease and remove dirt
- Safe for electrical equipment and non-flammable
- No rinsing or wiping required and does not leave a residue so your motors run efficiently
- An extension tube is furnished for pinpoint application



Carb & Choke Cleaner

Item No. ESG6201536

- Quick acting carburetor cleaner that penetrates and dissolves dirt and residue
- Eliminate hard starting, stalling, rough idling by loosening sticky valves, chokes, and risers
- Can be sprayed in any position and the extension tube gives you pinpoint accuracy



Silicone Lube

Item No. ESG6201500

- Clear silicone lubricant for use on all sliding and rubbing surfaces
- Authorized by USDA for use in Federally inspected meat and poultry plants
- Comes with an extension tube for pinpoint application, and sprays in any position
- Withstands high pressures, does not stain, and has low odor

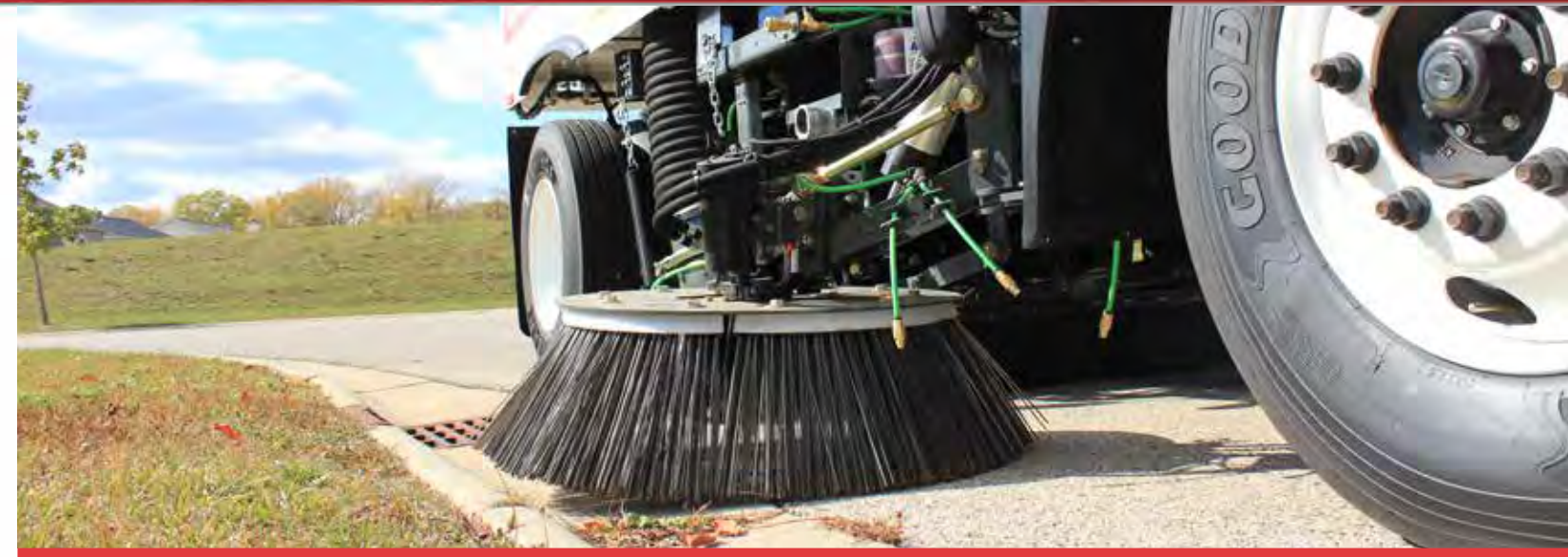

Tire Sealants

- Simply the finest tire sealant in the world. Our high-quality sealant not only seals tread area punctures but also rim and bead leaks, weather cracking and porosity leaks
- Seals hundreds of punctures up to 1/4" diameter
- Totally homogeneous—no mixing, shaking or stirring is necessary; it has an indefinite shelf life and can be rinsed out of a tire with water if there is a need for section or boot patching
- Remains fluid and effective in temperatures down to -45° F
- Lasts the life of the tire tread
- Easy installation is through the valve stem with the valve core removed and the tire deflated
- Installation kits are included
- Tire balance is not affected by sealant application
- Made in the USA

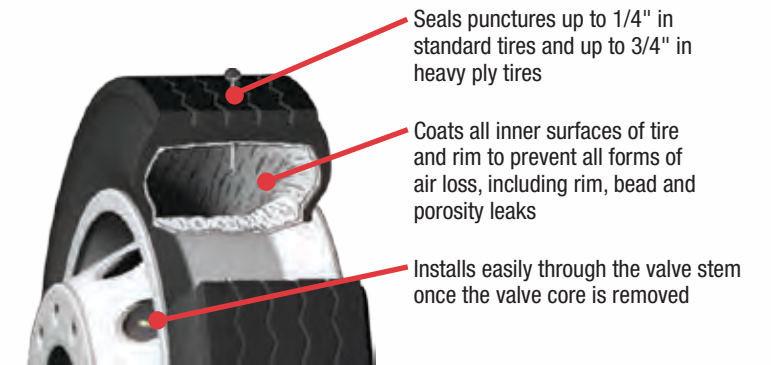

Seals punctures up to 1/4" in standard tires and up to 3/4" in heavy ply tires

Coats all inner surfaces of tire and rim to prevent all forms of air loss, including rim, bead and porosity leaks

Installs easily through the valve stem once the valve core is removed



ESG1220-0032

ESG1220-0640

ESG1220-7040

ESG1220-0128

Item No.	Description
ESG1220-0032	32 oz. Bottle
ESG1220-0128	1 Gallon with Pump
ESG1220-0640	5 Gallon
ESG1220-516	5 Gallon Pump
ESG1220-7040	55 Gallon Drum
ESG1220-35200	275 Gallon Tote
ESG1220-1614	Pneumatic Tire Sealant Pump

Powerful Corrosion Protection

- Superior lubrication for all moving parts
- Extend maintenance schedules, resulting in significant cost savings and integrity of equipment
- Soft, active coating penetrates to the base metal, where it migrates to create a formidable, protective barrier that prohibits corrosion on a molecular level
- Contains no solvents—will not evaporate

- Also protects equipment from atmospheric corrosion in storage facilities and metals exposed to animal waste
- Protects all metals, wiring systems and truck/machinery underbodies from the effects of harsh chemicals and toxic, dirty environments
- Not water soluble—resisting splash off from water, slush and mud during driving



8 oz. Brush Top Can

- Item No. ESGNAS80Z
- Eliminates messy overspray
 - Allows for desired consistency
 - Great for detail applications
 - Built-in brush applicator



Five Gallon Pail

- Item No. ESGNAS5GAL
- #1 choice for equipment being shipped or stored
 - Apply by pressurized spray, roller or brush
 - For larger applications

1.4mm Low Air HVLP Gravity Feed Spray Gun

Item No. ESG19000

- 600cc plastic paint cup
- Die cast aluminum body with anodized finish
- 2-step trigger control
- Non-bleeder type, gravity feed external mix
- Stainless steel nozzles
- Adjustable spray width, air inlet and fluid outlet
- PLUS - Locking pressure regulator with gauge
- 1.4mm stainless steel tip
- Brass fluid & air nozzle
- Nozzle size: 1/4"
- Air consumption: 4.0-7.0 CFM



11 oz. Aerosol Can

- Item No. ESGAS11
- Lubricates moving parts
 - Prevents corrosion on all metals
 - Long lasting protection
 - Easy to apply



One Gallon Pail

- Item No. ESGNAS1GAL
- Long term protection
 - Apply by pressurized spray, roller or brush
 - Easy to handle

Any Project. Any Surface. Any Time.

Whether you're doing a small repair or tackling a large project, we have all the products you need to get the job done right. No matter which product you choose, you always get the legendary performance of the world's strongest bond!



J-B Weld

- Item No. ESG8265S
- Will bond to most clean and dry surfaces and sets in 1-2 hours and will fully cure in 16-24 hours
 - Waterproof, petroleum, chemical and acid resistant when fully cured
 - Alternative to welding, soldering and brazing



J-B Stik

- Item No. ESG8267S
- Cures completely submerged in gas-oline or under water in 60 minutes
 - Steel reinforced epoxy putty stick
 - Hand kneadable epoxy adhesive will plug holes and make permanent repairs on wet and dry surfaces



J-B WaterWeld

- Item No. ESG8277
- Once cured it can be drilled, sanded, filed, tapped, machined and painted
 - Fully cure in 60 minutes and will adhere to most any surface
 - Make permanent repairs in moist or under water applications



J-B Kwik

- Item No. ESG8276
- Fast set - cure version of J-B Weld that will set in four minutes and fully cure in 4-6 hours
 - When fully cured it can be drilled, tapped, machined filed, sanded and painted
 - Waterproof, petroleum, chemical and acid resistant once fully cured



J-B KwikPlastic

- Item No. ESG8237
- Sets in 20 minutes
 - Bonds instantly with superior strength and does not shrink or pull away
 - Repair and rebuild any rigid and semi-flexible plastic including ABS, PVC and CPVC



11 oz. Smart Straw

- Never lose the straw again!
- Penetrate and loosen stuck, frozen parts
- Displace moisture on wiring and parts
- Remove grease and grime from parts and tools
- Shine bumpers and chrome
- Lubricate moving parts, hinges, valves, etc.

Item No.	Description
ESG110078	12 pack
ESG110075	48 pack with Display

ESG110075

ESG110078



20 oz. Classic

- Item No. ESG110184
- Penetrate & loosen stuck, frozen parts
 - Displace moisture on wiring & parts
 - Remove grease & grime from parts & tools
 - Remove adhesives, stickers, labels, road tar, bugs
 - Shine bumpers & chrome
 - Lubricate moving parts, hinges, valves, etc.



18 oz. Big Blast Can

- Item No. ESG10124
- New wide area spray nozzle
 - Delivers product quickly and efficiently over large areas
 - Cover everything—faster!
 - Stops squeaks
 - Removes and protects
 - Loosens rusted parts
 - Frees sticky mechanisms



11 oz. 3-in-One Garage Door Lube

- Item No. ESG100581
- Quick drying
 - Won't attract dust or dirt
 - Prevents rust and corrosion
 - 2-way spray technology
 - Stops squeaking and sticking
 - Great for commercial and residential garage doors



8 oz. 3-in-One Multi-Purpose Oil

- Item No. ESG10138
- Precise lubrication
 - Lubricates, cleans and prevents rust

Specialist® Professional Grade Aerosols



18 oz. Machine & Engine Degreaser Foaming Spray

- Item No. ESG300070
- Makes equipment run smoother, last longer and look like new
 - Quickly removes grease, oil, dirt and grime
 - Deep penetrating foaming action
 - Sprays up to five feet
 - NSF Category C1 (#146737)
 - 50-state VOC compliant



WD-40® Specialist® Product Line

- Smart Straw for precise application
- Superior performance
- 50-state VOC compliant

Item No.	Description
ESG300004	11 oz. Rust Release Penetrant
ESG300012	11 oz. Water Resistant Silicone
ESG300080	11 oz. Specialist Electrical Contact Cleaner
ESG300025	10 oz. White Lithium Grease

Striking Tools

Indestructible Handle Hammers

- Ergonomic rubber grip handle absorbs shock and vibration reducing fatigue
- Indestructible handle is made with spring steel bars that run all the way through the handle. Bars are locked with the hammer head using steel locking plates, ensuring that the head never gets dislodged
- Hammer head is forged from special steel and is induction hardened to 52 to 56 HRC for extended life
- Special bonding process ensures that head never gets loose from the handle
- Working temperature range: 14° F to 122° F (-10° C to 50° C)
- **Lifetime warranty on the handle**

Indestructible Handle Technology

Steel Locking Plate

Eliminates head getting loose or falling apart

Hi Visibility Head

Adds instant identification on any job site

Vulcanized Rubber Grip

Absorbs impact & vibration, reducing user fatigue

Drop Forged Head

With striking ends induction hardened 52-56 HRC

Textured Non-Slip Grip

Spring Steel Bars

9/32" diameter spring steel bars resist overstrike without breaking

Steel Reinforced Lanyard Hole

Club Hammers

Item No.	Head Weight	Handle Length
ESG34500	2.5 lbs.	12"
ESG34501	4 lbs.	12"
ESG34502	4 lbs.	16"



Ball Pein Hammers

Item No.	Head Weight	Handle Length
ESG34540	24 oz.	14"
ESG34541	32 oz.	14"
ESG34542	48 oz.	14"



Cross Pein Hammers

Item No.	Head Weight	Handle Length
ESG34530	2 lbs.	16"
ESG34531	3.5 lbs.	16"



Sledge Hammers

Item No.	Head Weight	Handle Length
ESG34510	6 lbs.	24"
ESG34511	6 lbs.	30"
ESG34512	8 lbs.	24"
ESG34513	8 lbs.	30"
ESG34517	8 lbs.	36"
ESG34514	10 lbs.	30"
ESG34518	10 lbs.	36"
ESG34515	12 lbs.	30"
ESG34519	12 lbs.	36"
ESG34516	14 lbs.	30"
ESG34520	14 lbs.	36"



Alignment & Pry Bars

Aligning Bars

- Heavy-duty bars are forged from chrome alloy steel and heat treated to resist bending and breaking
- The prying end is on one side and aligning end on the other
- These come in plated finish which makes it easier to locate in a crowded workshop
- The longer lengths come in a powder coated finish
- Ideal for leverage, positioning, prying and demolition

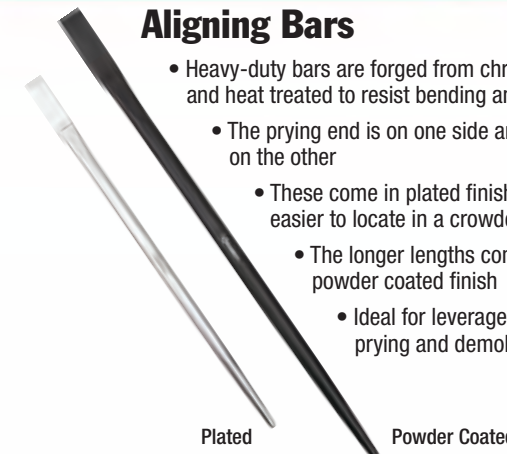

Roll Head Pry Bars

- Forged from Chrome Vanadium Steel and fully hardened and tempered
- Roll head acts as a fulcrum and provides leverage
- Designed for heavy prying and fulcrum prying—very useful in automotive applications
- The tapered end is used for aligning
- Ideal for leverage, positioning and prying



Item No.	Length	Stock Size	Finish
ESG33169	16"	5/8"	Plated
ESG33170	18"	5/8"	Plated
ESG33171	24"	3/4"	Plated
ESG33172	30"	7/8"	Plated
ESG33173	36"	7/8"	Plated
ESG33176	48"	1"	Powder Coated
ESG33177	54"	1"	Powder Coated

Item No.	Length	Stock Size
ESG33150	6"	5/16"
ESG33151	12"	7/16"
ESG33152	16"	9/16"
ESG33153	20"	11/16"
ESG33155	Set of 3 Pry Bars, containing one each of 12", 16" and 20"	



Hand Tools & Storage

Tool Storage



36" Service Box

Item No. ESG36SBOX

- 16/18-gauge steel construction—over 5-1/2" deeper than our previous model
- Specially engineered frame with handles make it easy to slide and move service box
- 5 big reinforced drawers with quiet ride foam liners—2 deep and 3 standard size drawers
- Full-extension friction slides for smooth glide operation
- Deep drawers feature dual slides and load rated up to 300 lbs, standard feature single slides and load rated up to 150 lbs.
- Theft-resistant tubular, coded lock and keys
- Caster-ready (casters sold separately)
- Specially designed with room underneath to allow forklift to easily move fully loaded box



24" Plastic Hand Box with 3 Steel Drawers

Item No. ESGPP-2314BKX

- 24"W x 10-1/2"D x 13-1/2"H
- Portable workstation at your fingertips
- Steel drawers with 25 lb. capacity
- Rugged high-impact polypropylene will not rust, dent, corrode or mar surfaces



20" Plastic Hand Box with Tray

Item No. ESGPP-2009BKX

- 20"W x 10.3"D x 9"H
- Ideal for carrying in the field and out to the job
- Includes removable plastic tray
- Rugged high-impact polypropylene will not rust, dent, corrode or mar surfaces



5" x 2" Casters for Service Box

Item No. ESG452CS

- Set includes: Four (4) caster wheels (all swiveling, all with brake mechanisms)
- Wheel Size: 5" diameter x 2" wide
- Plate Size: 95mm x 65mm (3.74" x 2.56")
- Load Rating: 1,320 pounds total per set of 4 (330 pounds each caster)
- Height: Approximately 6" from top of plate to bottom of wheel
- Strong, double zinc coated galvanized steel
- Heavy duty non-marking TPR rubber wheels
- Premium swivel design, with two rows of ball bearings (many others only have 1)
- One year guarantee against workmanship and defects



48" On-Site Storage Box

Item No. ESG48SBOX

- 48-1/8"W x 24-1/8"D x 28-3/8"H
- Storage capacity: 27,760 cu. in.
- Heavy duty steel construction with 12 gauge steel legs provide 4 way entry skid
- Reinforced overlapping lid provides protection from weather
- Recessed locking area protects contents
- Heavy duty industrial lid stays open to prevent accidental closure
- Tough industrial powder coated finish
- Custom imprinting available for this product, see website for details

Tool Storage

26" Tool Chest & Cabinet

Item No. ESG26COMBOBLK

26" 7 Drawer Professional Tool Chest

Item No. ESG26TOPBLK

26-1/2" 5 Drawer Professional Roller Cabinet

Item No. ESG26CABBLK

- Drawers feature ball bearing glides with a load capacity of 50 lbs. per drawer and 100 lbs. per drawer with double glides (double glides only on roller cabinet deep drawers)
- High density foam drawer liners included
- Heavy duty steel construction with four 4" x 2" casters (two lockable swivels and two rigid)
- High gloss powder coated finish
- Theft-proof tubular coded locking system keeps your tools safe

Item No.	Width	Depth	Height
ESG26TOPBLK	26"	16"	18"
ESG26CABBLK	27"	18"	36"



41" Tool Chest & Cabinet

Black: Item No. ESG41COMBOBLK

Blue: Item No. ESG41COMBOBLU

41" 8 Drawer Professional Tool Chest

Black: Item No. ESG41TOPBLK

Blue: Item No. ESG41TOPBLU

41-1/2" 11 Drawer Professional Roller Cabinet

Black: Item No. ESG41CABLK

Blue: Item No. ESG41CABLU

- Drawers feature ball bearing glides with a load capacity of 100 lbs. per drawer and 200 lbs. per drawer with double glides
- Full-width aluminum polished chrome drawer pulls
- Heavy duty 16 gauge steel frame and 18 gauge steel sides with four 5" x 2" casters (two lockable swivels and two rigid)
- High density foam drawer liners included
- High gloss powder coated finish
- Theft-proof tubular coded locking system keeps your tools safe

Item Desc.	Width	Depth	Height
Tool Chest	41"	17-3/4"	21-3/8"
Roller Cabinet	41-1/2"	18-1/8"	40-1/2"





56" Tool Chest & Cabinet

Black: Item No. ESG56COMBOBLK
Blue: Item No. ESG56COMBOBLU

56" 10 Drawer Professional Tool Chest

Black: Item No. ESG56TOPBLK
Blue: Item No. ESG56TOPBLU

56" 11 Drawer Professional Roller Cabinet

Black: Item No. ESG56CABBLK
Blue: Item No. ESG56CABBLU

- Drawers feature ball bearing glides with a load capacity of 100 lbs. per drawer and 200 lbs. per drawer with double glides (double glides only on roller cabinet deep drawers)
- Full-width aluminum polished chrome drawer pulls
- Heavy duty steel construction with six 5" x 2" casters (four lockable swivels and two rigid)
- High density foam drawer liners included
- High gloss powder coated finish
- Theft-proof tubular coded locking system keeps your tools safe

Item Desc.	Width	Depth	Height
Tool Chest	55-1/4"	19-3/4"	20-1/2"
Roller Cabinet	56"	20"	41-1/2"



72" 17 Drawer Professional Roller Cabinet

Black: Item No. ESG72CABLK
Blue: Item No. ESG72CABLU

- 72"W x 30"D x 44-3/4"H
- Drawers feature ball bearing glides with a load capacity of 300 lbs. per drawer and 600 lbs. per drawer with double glides
- High density foam drawer liners included
- Heavy duty 11 gauge steel construction with six 6" x 2" casters (four locking and two swivel)
- High gloss powder coated finish
- Theft-proof tubular coded locking system keeps your tools safe



72" Shop Cabinet

Item No. ESG72BLK

- Professional Grade
- Welded steel construction stands up to constant use
- 4 adjustable shelves hold up to 180 lb. each
- 3-point locking system locks the doors on top, side and bottom
- Durable baked enamel finish resists dents and scratches
- Meets or exceeds ANSI/BIFMA standards
- Comes assembled except handles, locking system and shelves
- **Custom imprinting available for this product, see website for details**



76" 12 Drawer Professional Roller Cabinet

Black: Item No. ESGEX7612RCBLK
Blue: Item No. ESGEX7612RCBLU

- 76"W x 31"D x 47"H

- Drawers feature ball bearing glides with a load capacity of 300 lbs. per drawer and 600 lbs. per drawer with double glides
- High density foam drawer liners included
- Heavy duty 11 gauge steel construction with six 6" x 2" casters (four lockable swivels and two rigid)
- High gloss powder coated finish
- Theft-proof tubular coded locking system keeps your tools safe
- Mounted four outlet A/C powerstrip
- 12 deep drawers including two extra wide drawers and one vertical power tool drawer



ELGIN[®]
Subsidiary of Federal Signal Corporation

VACTOR[®]
Subsidiary of Federal Signal Corporation

For all of your
Shop & Safety Essentials
Visit us online at
www.elginvactor essentials.com

© 2016 Elgin Sweeper Co.,
Subsidiary of Federal Signal Corporation.

© 2016 Vactor Manufacturing, Inc.
Subsidiary of Federal Signal Corporation.

Printed in the USA. Some items shown may be optional. Specifications subject to change without notice.

www.elginvactor essentials.com