

Commercial Granular Ice Maker

User Manual for Installation and Maintenance



Table of Contents

Important Information	1
Warning and safety instruction	2
General	4
Installation.....	4
Location for Installation	4
Schematic Diagram of Installation	5
Installation steps.....	6
Startup and Operation	7
Operating instruction	8
Instruction of Control Panel	9
Care and maintenance	11
Service call	12
Common Faults and Troubleshooting	13
Warranty	14

 Note: please keep this manual in a place accessible to users at any time.

Important Information

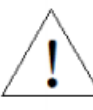
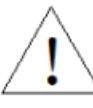

Please pay attention to the following injury risk reminders on the Granular Ice maker!

	<p> NOTICE</p> <p>Risk of electric shock. Disconnect power before maintenance.</p>
	<p> NOTICE</p> <p>Please contact professional person or manufacturer if you have any problem.</p> <p style="text-align: right;"><small>12.0.0062-01</small></p>

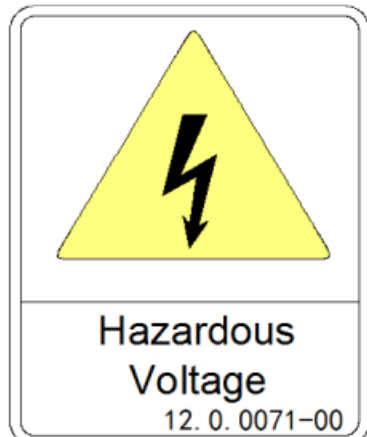
It indicates a dangerous voltage and risk of electric shock.



It indicates a dangerous voltage and risk of electric shock.

	<p> DANGER</p> <p>Rotating components inside, which can cause serious injury. Do not operate with panels open. Disconnect power before maintenance.</p> <p style="text-align: right;"><small>12.0.0039-00</small></p>
---	---

It indicates a rotating component, which may cause mechanical injury.

 <p>Warning: Fire Hazard Combustible Material</p>	<h1>Cyclopentane</h1> <p style="text-align: right;"><small>12.0.0069-01</small></p>
--	---

It indicates that the internal insulation is composed of flammable foaming agent cyclopentane. Please pay attention to the risk of fire.





R290

It indicates that the flammable refrigerant R290 is used in this machine. Please pay attention to the risk of fire.

 **Warning:** The ice making water inlet of ice maker can only be connected with drinking water, and groundwater or other non drinking water sources can not be used.

Instruction of symbols in this Manual

 Alert sign: indicating the item requiring particular attention.

 Warning sign: special attention is required and operation is prohibited.

Warning and safety instruction

 **This product must not be used outdoors.**

 **The Granular Ice maker is not intended for use by children or people with weak physical abilities, slow responses or mental disorders.**

- ✦ The Granular Ice maker must be installed, repaired or maintained by professional and qualified personnel. Otherwise, electric shock, fire or personal injury may be caused due to incorrect operations.
- ✦ The Granular Ice maker should be handled or installed with special loading and unloading tools. It is forbidden to manually handle or install the Granular Ice maker.
- ✦ Upon arrival, the Granular Ice maker should be kept upright for more than 24 hours for full precipitation of lubricating oil in the compressor before startup. Otherwise, the compressor may be damaged.
- ✦ When the power cord of the ice maker is damaged, in order to avoid electric shock, fire or personal injury, it must be replaced by the manufacturer or professional and qualified personnel.
- ✦ The water pipe assembly in the accessory box of the ice maker must be used. In order to ensure food safety, the water pipe assembly removed from the old machine should not be used.
- ✦ The Granular Ice maker must not be kept in a humid or splash-prone place.
- ✦ The ground wire of the Granular Ice maker must not be connected to the gas pipe, water pipe, telephone line, lightning rod and the like.
- ✦ Since there are rotating parts in the Granular Ice maker, it is forbidden to insert thin objects into vents and exhaust ports; otherwise, mechanical damage may be caused.
- ✦ It is forbidden to store volatile or flammable substances in the Granular Ice maker; otherwise, an explosion or fire may be caused.
 - ✦ It is forbidden to keep any sundries or freeze or refrigerate any food in the ice bin of the Granular Ice maker. The ice shovel should be kept clean.
- ✦ The Granular Ice maker must be kept on a ground that is strong enough to withstand its weight. If the ground is unsecure, the product may tip over to cause injury.
- ✦ A sufficient ventilation space should be kept around the Granular Ice maker to ensure smooth ventilation.
- ✦ Please use the power supply specified on the nameplate of the Granular Ice maker.
- ✦ Hot water must not be used in the Granular Ice maker.
- ✦ A socket grounded reliably and subjected to leakage protection should be used for the Granular Ice maker.
- ✦ The Granular Ice maker must be powered off before manual cleaning and maintenance.
- ✦ Prior to cleaning and maintenance, the remaining ice in the ice bin should be removed out of the Granular Ice maker, to avoid ice contamination during cleaning and maintenance.
- ✦ It is forbidden to directly pour water to rinse the surface of the Granular Ice maker; otherwise, faults such as short circuits and leakage may be caused.
- ✦ The insulation of the Granular Ice maker is composed of flammable foaming agent, which must be treated and recycled by qualified personnel and agencies when discarded.
- ✦ The Granular Ice maker should be managed reasonably to prevent any operation by children.
- ✦ If the Granular Ice maker fails, turn off the power supply and contact professional personnel for repair.



R290

For the ice maker with flammable refrigerant R290:

- DANGER – RISK OF FIRE OR EXPLOSION. FLAMMABLE REFRIGERANT USED. MUST BE ENOUGH VENTILATION SPACE AROUND THE ICE MAKER TO KEEP THE VENTILATION SMOOTH.
- DANGER – RISK OF FIRE OR EXPLOSION. FLAMMABLE REFRIGERANT USED. DO NOT USE MECHANICAL DEVICES TO DEFROST REFRIGERATOR. DO NOT PUNCTURE REFRIGERANT TUBING.
- DANGER – RISK OF FIRE OR EXPLOSION. FLAMMABLE REFRIGERANT USED. TO BE REPAIRED ONLY BY TRAINED SERVICE PERSONNEL. DO NOT PUNCTURE REFRIGERANT TUBING.
- DANGER – RISK OF FIRE OR EXPLOSION. FLAMMABLE REFRIGERANT USED. DO NOT USE ANY ELECTRICAL APPLIANCES IN THE ICE STORAGE BIN OF THE ICE MAKER.
- CAUTION – RISK OF FIRE OR EXPLOSION. FLAMMABLE REFRIGERANT USED. CONSULT REPAIR MANUAL/OWNER'S GUIDE BEFORE ATTEMPTING TO SERVICE THIS PRODUCT. ALL SAFETY PRECAUTIONS MUST BE FOLLOWED.
- CAUTION – RISK OF FIRE OR EXPLOSION. DISPOSE OF PROPERLY IN ACCORDANCE WITH FEDERAL OR LOCAL REGULATIONS. FLAMMABLE REFRIGERANT USED.
- CAUTION – RISK OF FIRE OR EXPLOSION DUE TO PUNCTURE OF REFRIGERANT TUBING; FOLLOW HANDLING INSTRUCTIONS CAREFULLY. FLAMMABLE REFRIGERANT USED.

General

This automatic Granular Ice maker should be connected with a drinking water source and power supply. After it is installed properly, the Granular Ice maker can be started for normal ice making. When the ice bin is full of Granular ice, the machine will automatically stop running. The Granular Ice maker is usually used in the following and similar occasions, such as:

- Kitchen areas in shops, offices or other workplaces;
- Preservation areas of supermarkets and aquatic products;
- Storage areas of laboratories and medical occasions;
- Preservation and cooling during long-distance transportation;
- Catering industry and similar non-retail occasions.
- Under normal circumstances, the Granular Ice maker is not for home use.

Installation

Location for Installation

The installation location should meet the following conditions:

- Indoors, at an altitude of 2000 m or less;
- Ambient temperature: 5-40°C;
- Power supply: Rated voltage in the nameplate $\pm 6\%$;
- Water source: drinking water source, with a pressure of 0.13MPa to 0.55MP (inclusive) and temperature of 5-35 °C.
- The Granular Ice maker should be kept away from heat sources. It must not be used at high or low temperatures. It should also be kept away from direct sunlight, in order not to affect its heat dissipation and service life.
- A sufficient ventilation space should be kept around the Granular Ice maker to ensure smooth ventilation. The spacing should be at least 30 cm in front of the Granular Ice maker, 20 cm from its back and 15 cm from its side faces.
- The Granular Ice maker must be kept on the ground that is strong enough to withstand its weight.
- A socket grounded reliably and subjected to leakage protection should be used for the Granular Ice maker.
- There must be a suitable floor drain near the installation location of the Granular Ice maker.

Schematic Diagram of Installation

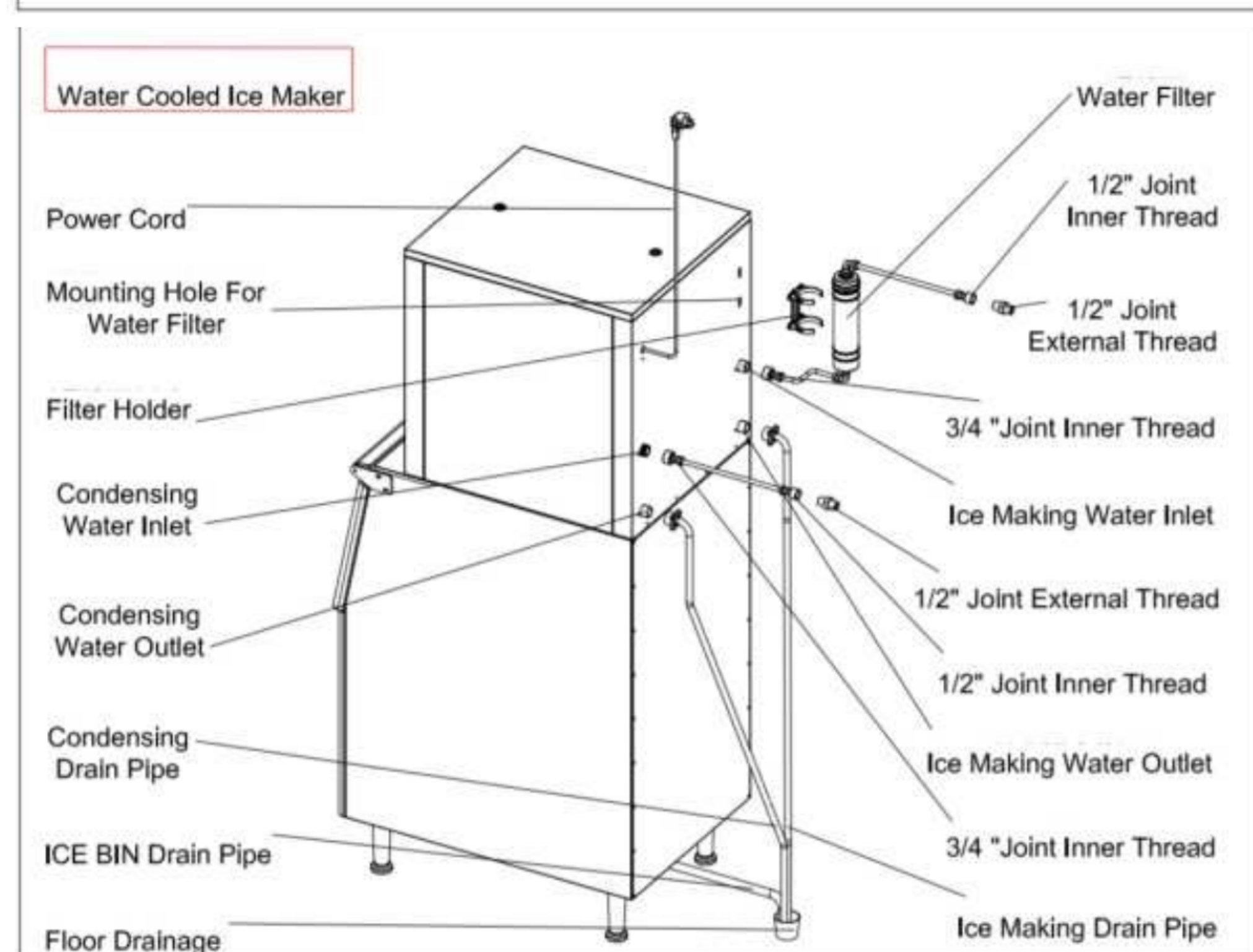
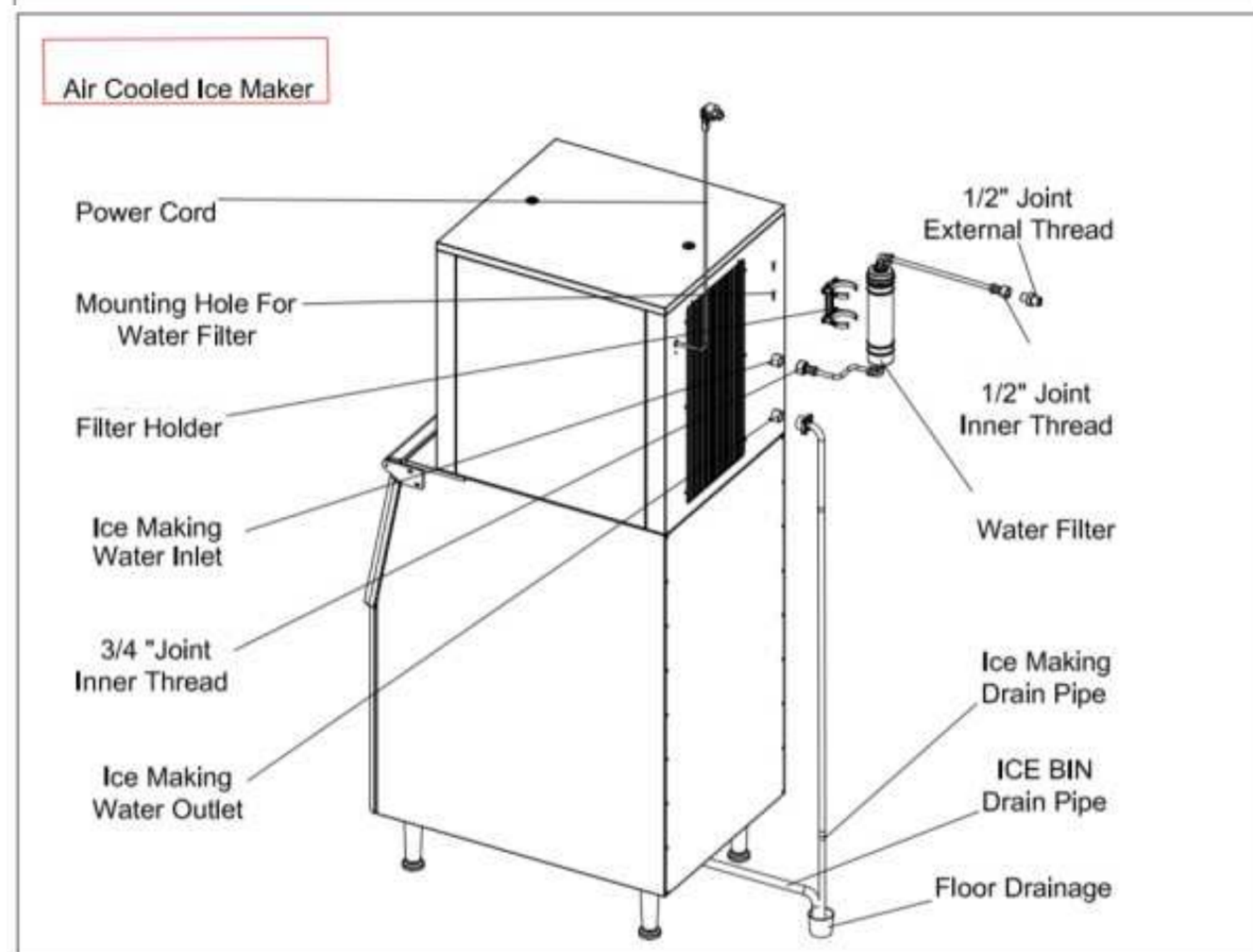
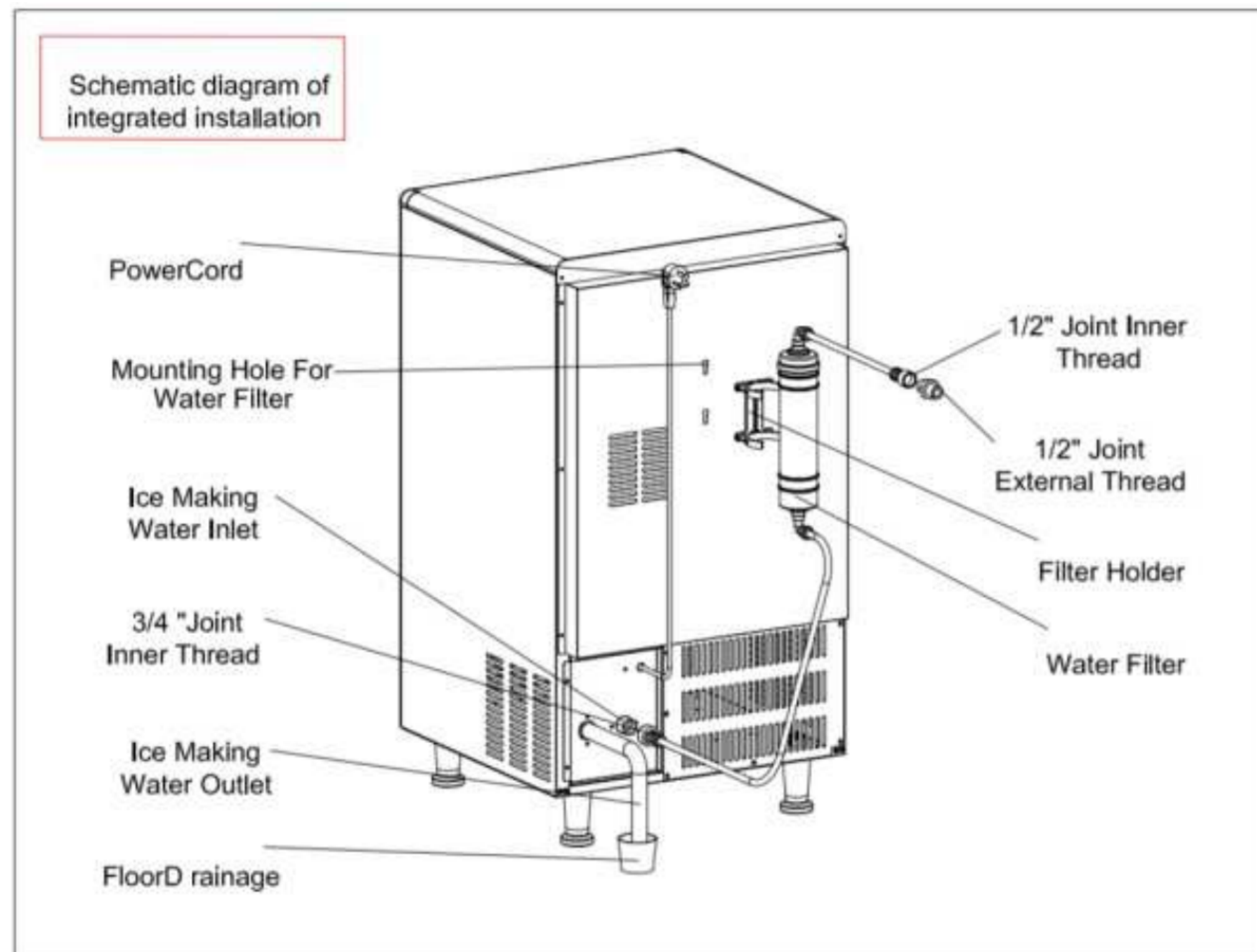

Installation steps

1. Check whether the Granular Ice maker is in good conditions and whether its accessories are complete. Check the model and nameplate of this machine.
2. Clean the ice bin and inside of this machine with the sponge containing warm water and baking soda. Then rinse and dry them.
3. Install the Granular Ice maker horizontally.
4. The air-cooled Granular Ice maker should be installed in a well-ventilated place to ensure its excellent output. Accordingly, a ventilation space (20-30 cm) must be kept on the left and right of the Granular Ice maker.
5. There are adjustable legs at the bottom of the Granular Ice maker to facilitate level adjustment and floor cleaning.
6. Connect the water inlet filter and water pipe as shown in the figure. If a drinking water system is available at the installation site, it is not necessary to install the water filter.
7. Connect this machine to water supply pipe via the 1/2" joint (provided along with the machine). It is recommended to install a water valve (not provided along with the machine) on the water supply pipe.
8. Connect the supplied drain pipe to drain port. To facilitate drainage, the recommended drop for the drain pipe is greater than 3 cm. Make sure that the drain pipe is not blocked. It is recommended to connect the drain pipe to drain port.
9. Any node in the drain pipe must not be higher than the drain port or previous node.
10. Make sure of the power requirements in the nameplate to guarantee the compliance of the power supply.
11. Install a circuit breaker or switch on the power supply line. In addition, install a leakage protector and make it grounded reliably.
12. Turn off the switch on the power supply line, and then connect this machine with the power supply.

⚠Note: The water inlet and outlet directions are marked on the filter cover or bottle. The filter must be installed in the correct direction.

⚠Note: The water inlet filter provided with this product should be used to continuously filter impurities in water. Under normal circumstances, the filter should be replaced once every one to three months.

Startup and Operation

13. Before startup, make sure that:

- The accessories or items in the Granular Ice maker have been taken out;
- The Granular Ice maker has been adjusted to the horizontal state;
- The water pipe has been connected and the water valve has been opened;
- The plug has been connected to the power supply, and the power switch is turned off;
- Ensure that the ambient temperature, water temperature and water supply pressure are within the specified ranges.

14. Startup: Turn on the power switch on the power supply line. When this machine is

powered on, and press the “Switch”  button on the display panel. This machine will be in the status of automatic ice making.



15. Inspection in normal operation:

- ✓ Make sure that ice can fall off normally.
- ✓ For the air-cooled Granular Ice maker, make sure that the fan works properly, and the air flows steadily at the inlet and outlet of the Granular Ice maker;
- ✓ Make sure that the Granular Ice maker has no abnormal noise;
- ✓ Make sure that the Granular Ice maker has no abnormal vibration.

Operating instruction

- **Start up:** After the correct installation, turn on the water source and power supply. Then press the “Switch”  button on the display panel. The machine will be in the status of normal operation. It will work automatically in an unattended manner in the whole running process. Make sure that this machine is running normally after the first startup.

⚠Note: If exposed to thunderstorms or not in use from a long time, please cut off the power supply and water source!

- **Preparation:** After the Granular Ice maker is powered on, press the “Switch”  button on the display panel. Following the 10-second countdown, the balance valve, reducer, fan, compressor will be started in sequence.
- **Ice making:** The continuous water flow is stored in the inner wall of the evaporator, where it freezes. It is cut by the ice drill driven by the reducer and is taken out of the evaporator through the spiral ice blade.
- **Water shortage restart:** When there is not adequate water to meet the needs for normal ice making, the LED “low water level” indicator on the display panel will be normally ON. When the normal water supply is recovered, the “low water level” indicator will be OFF. After some time, the machine will be restarted, and the “Water shortage restart” indicator will be normally ON. Following the 10-hour normal operation, the “Water shortage restart” indicator will be OFF automatically.
- **Shutdown:** In the running status, press the “Switch”  button on the panel. The compressor will immediately stop working. After the 60-second countdown on the display panel, the reducer and fan will be shut down, and the machine will be OFF.
- **Automatic shutdown with full ice:** In the running status, as Granular ice in the ice bin increases to a certain height, blocking the infrared correlation between the transmitter and receiver of the full ice switch(The ice full switch is located at the lower end of the ice cylinder or under the ice outlet). After some time (60s), this machine will confirm the full ice in the ice bin and automatically stop running.
- **Ice marking recovery after ice removal:** As Granular ice in the ice bin is taken out, the ice height will decrease. This will be detected in two minutes, followed by normal ice making.

Instruction of Control Panel

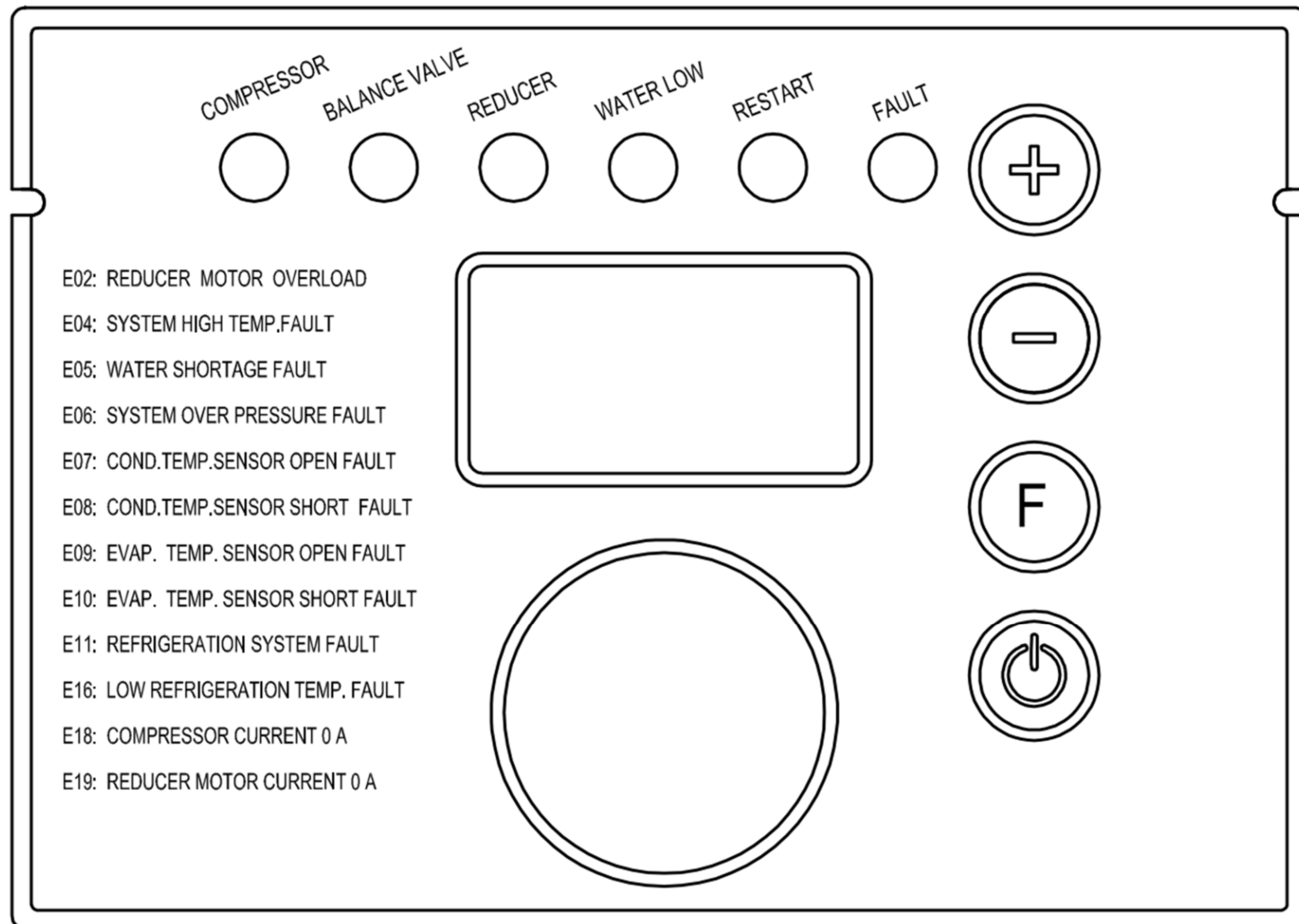

1. Digital tube: Display different contents at each stage:
 - a) Preparation: 10-second countdown.
 - b) Ice making: Display the compressor current (unit: A) by default. Press the function key to alternately display the reducer current (unit: A) and condensate temperature (unit: °C).
2. LED indicator: Display the status of the Granular Ice maker, including the compressor, reducer, low water level, water shortage restart and other faults.
3. Switch: When the machine is powered on, press the "Switch"  button to shut down and start up the machine.
4. Gently open and close the door of the ice bin instead of slamming. After taking out ice, close the door of the ice bin.
5. If the Granular Ice maker has been used for some time and will not be in use in a long term, it should be powered on and kept running for 2-4 hours once every two months.

Other special shutdown protection

- If the ambient temperature is found too high, the Granular Ice maker will be shut down for protection.
- When an abnormality is detected in the water inlet pipe, the water-cooled Granular Ice maker will be shut down for protection.

- When a fault occurs, the fault code and note will be displayed as follows.

Code	Note	Machine action
E01	COMPRESSOR OVER LOAD	Shutdown for protection
E02	REDUCER OVER LOAD	Shutdown for protection
E04	HIGH TEMP. FAULT	Shutdown for protection
E05	WATER SHORTAGE FAULT	Shutdown for protection
E06	HIGH PRESSURE FAULT	Shutdown for protection
E07	COND.TEMP.OPEN CIRCUIT FAULT, displayed once every 5 seconds	Without shutdown
E08	COND.TEMP.SHORT CIRCUIT FAULT, displayed once every 5 seconds	Without shutdown
E09	EVP.TEMP.OPEN CIRCUIT FAULT	Shutdown for protection
E10	EVP.TEMP.SHORT CIRCUIT FAULT	Shutdown for protection
E11	REFRIGERATION SYSTEM FAULT	Without shutdown
E16	LOW REFRIGERATION TEMP.FAULT	Shutdown for protection
E18	COMPRESSOR CURRENT 0A	Shutdown for protection
E19	REDUCER CURRENT 0A	Shutdown for protection

Care and maintenance

⚠️ Note: Maintenance and care must be conducted by qualified professionals.

⊘ Warning: Before maintenance and manual cleaning, turn off the water source and power supply and remove the plug. Live operations are prohibited.

External cleaning

- Always clean the area around the Granular Ice maker. Never block the vents.
- The shell should be cleaned with neutral detergent and wiped with soft cloth. If necessary, use the commercial stainless steel cleaner and polishing agent.

⚠️ Note: Stainless steel may also be subject to rusting in the case of no proper maintenance.

Inlet filter

- The filter element should be checked regularly. It is recommended to replace the filter element once every **one to three** months.

Internal cleaning of ice bin

- The inside of the ice bin can be rinsed directly with a water pipe.

Full ice switch

- It is recommended to wipe the lens of the transmitter and receiver of the full ice switch once every **one to three** months.

⚠️ Note: The fins of the air condenser are sharp. Be careful during cleaning!

Waterway

- To ensure food hygiene, the waterway of the Granular Ice maker should be cleaned regularly.

Overwinter

- Turn off the water source and power supply, and drain the remaining water in the water tank and water inlet pipe of the Granular Ice maker.

⚠️ Maintenance of the Granular Ice maker is excluded from the manufacturer's warranty!

Condenser

- The condenser of the **air-cooled Granular Ice maker** needs to be cleaned once every three weeks by brushing vertically with a soft brush or vacuum cleaner with a brush along the fin, thus avoiding damage to the fins and influence on cooling.
- The stainless steel filter should be cleaned once every half a month.
- Schematic diagram for removal of the stainless steel filter (Picture 1): Gently press two buckles on the ventilation window to the middle, and remove the ventilation window. Then pull out the filter from the side of the ventilation window.
- Schematic diagram for removal of the plastic filter (Picture 2): As shown in the figure:

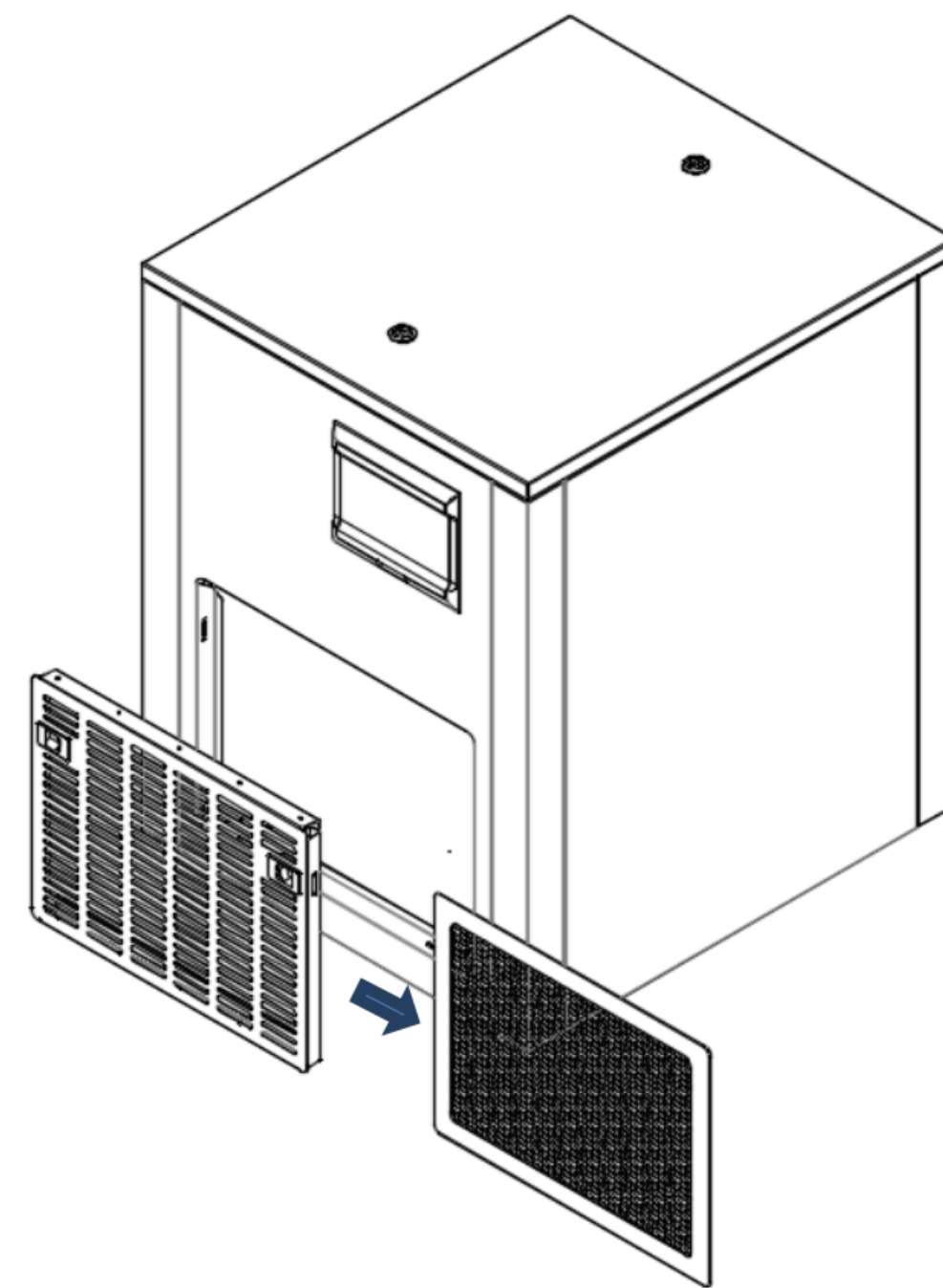

Figure 1

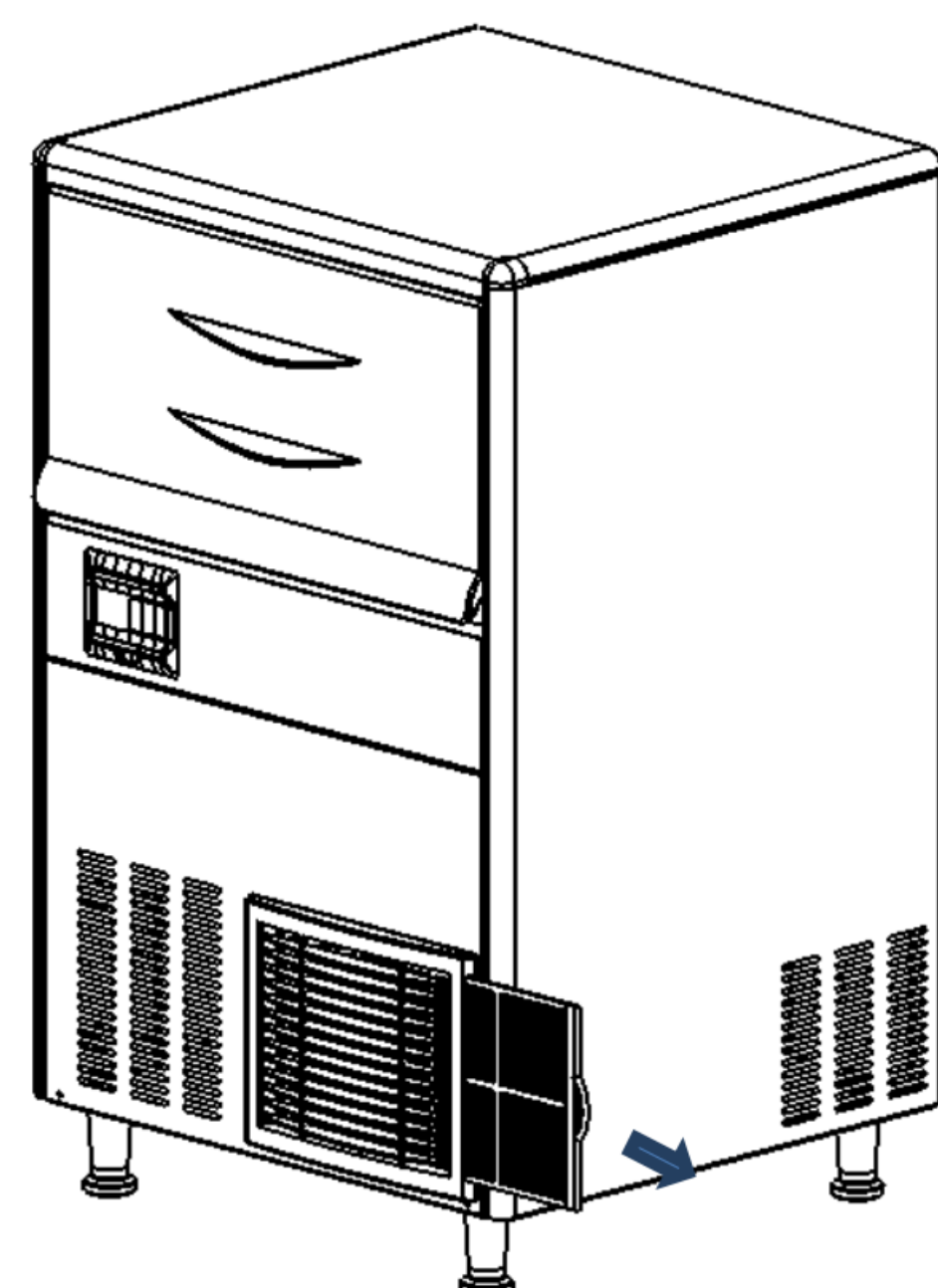

Figure 2

Service call

In the case of any abnormality, make sure of the following items before making a call.

1. Check whether the water source is in good conditions.
 - ✓ Check whether the LED “low water level” indicator on the display panel is always ✓ ON.
 - ✓ Make sure that the pressure of water in the Granular Ice maker is 0.13Mpa to 0.55 Mpa(inclusive), and its temperature is 5-35°C.
 - ✓ Make sure that the water valve has been opened.
 - ✓ Make sure that there is no water leakage.
2. Check whether the power supply is

connected.

- ✓ Make sure that the indicator on the display panel is ON.
 - ✓ Make sure that the OFF status is not shown on the display panel.
If the LED indicator on the display panel is ON, check whether the power plug and socket are in good conditions, and whether the switch on the power supply line and circuit breaker on the back are ON.
3. Check the nameplate and machine number.
 - ✓ Check the nameplate on the side face of the Granular Ice maker, and record the model and number of the Granular Ice maker.

⚠Note: If on-site services are requested for the reasons (e.g. no water, no electricity, environmental factors) of users, instead of the faults of this machine, these on-site services will be charged.

Common Faults and Troubleshooting

Fault/Phenomenon	Potential cause	Troubleshooting
The Granular Ice maker cannot be started. The indicator on the display panel is not ON.	The power switch is not turned on. The plug is loose.	Turn on the power switch. Check the plug and socket.
The Granular Ice maker will automatically stop running 3 minutes after startup, and the display screen shows "E04 HIGH TEMP. FAULT". The display screen shows "E06: HIGH PRESSURE FAULT".	Ambient temperature is too high The condenser is dirty or blocked. The high-voltage switch harness is disconnected. The fan is not started properly.	Normal working temperature range: 5°C~40°C. Clean the condenser. Check the high-voltage switch harness and take corrective actions. Check the fan and take corrective actions. Cooling water inlet is not opened
Ice cannot be made normally.	The environment temperature is too low	Normal working temperature range: 5°C~40°C.
The ice output is not sufficient.	The condenser or filter is dirty. The ambient temperature is high. Ventilation is in poor conditions. The water temperature is too high.	Clean the condenser and filter. Normal working temperature range: 5°C~40°C. Check the area around the Granular Ice maker. Check whether the water temperature is 5-35°C.
There is too much noise.	The Granular Ice maker is not secured or its legs are suspended.	Keep the Granular Ice maker secured.

Warranty

The following situations are excluded from the warranty of the Granular Ice maker:

- Normal cleaning, care, adjustment and maintenance;
- Changes in the Granular Ice maker without permission, or use of the parts that are not supplied with the machine;
- Damage caused by improper power supply, water supply and drainage;
- Failure to comply with the instructions during installation, cleaning or maintenance of the Granular Ice maker, resulting in damage;
- Equipment damage caused by scale due to low quality of water source;
- Man-made damage.

⚠Note: The warranty services will be provided by an agent or maintenance organization approved by the company.

Note: this Manual is subject to any technical change without further notice. Please refer to the nameplate on the product for exact information.