

Project Name: _____ AIA#: _____

Model #: _____ Location: _____

SIS#: _____ Item #: _____ Quantity: _____



The Perfect Mix of Performance and Value

8 Quart Planetary Countertop Power Mixer

Small Size, Big Performance

Perfect for restaurants, culinary schools, bakeries and small kitchens.



Model

SP8

Standard Features

- Powerful 1/4 HP custom built motor
- Three fixed speeds
- Thermal overload protection
- Front mounted touch pad control panel with 15-minute digital timer
- Removable splash cover and bowl lift
- 6-foot cord and ground plug
- Gear-driven, high-torque transmission
- Heat-treated hardened steel alloy gears & shafts
- Permanently lubricated transmission
- Rigid cast aluminum body

Standard Accessories/Attachments

- 8 qt stainless steel bowl (#304 series)
- Aluminum flat beater
- Stainless steel wire whip
- Aluminum spiral dough hook
- Polycarbonate splash cover with ingredient chute

Warranty

- Two year parts and labor

Optional Accessories/Attachments

- Stainless steel flat beater
- Stainless steel spiral dough hook
- Mixer table with undershelf
- Extended warranty

To select options, see complete list on back



Approved by: _____ Date: _____

2153 Dryden Rd., Dayton, OH 45439 | 937-299-5493 | 800-347-5423 | Fax: 937-299-4147 | www.globefoodequip.com

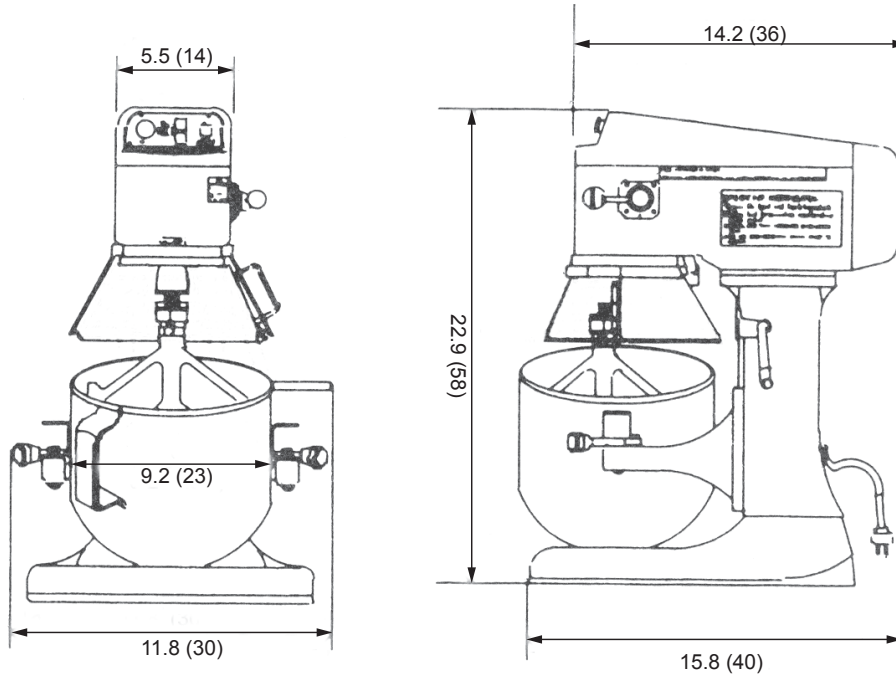

Drawings available through KCL at www.kclcad.com.

SPECIFICATIONS

Model	Motor	Volts	Amps	Transmission Type	Capacity	Controls	Agitator Speeds (RPMs)		
							1st	2nd	3rd
SP8	1/4 HP	115/60/1	5	Gear	8 qt 7.6 liter	Front-mounted digital controls & timer	132	234	421

Cord & Plug: Attached 6-foot flexible 3-wire cord with molded plug fits a grounded receptacle. NEMA 5-15P

DIMENSIONS | SHIPPING INFORMATION

Carton reinforced for shipping. The weight and dimensions of this reinforced carton are included below and may vary from shipment to shipment.

Model	Overall Dimensions	Net Wt	Shipping Dimensions	Shipping Wt
SP8	11.8" w x 15.8" d x 22.9" h (30 cm x 40 cm x 58 cm)	55 lbs (25 kg)	14" w x 18" d x 26" h (35 cm x 45 cm x 66 cm)	62 lbs (28 kg)

Mixer is constructed of a rigid cast aluminum body with 3 fixed speeds. Unit has a 1/4HP motor with thermal overload protection and a gear-driven, high torque, permanently lubricated transmission. Mixer comes with 8 qt. stainless steel bowl, flat beater, wire whip, dough hook and removable splash cover with ingredient chute. Mixer has safety interlocked bowl lift. Mixer is NSF and ETL listed. Two year parts and labor warranty.

OPTIONAL MIXER ACCESSORIES AND HUB ATTACHMENTS

MIXER:

- XXBOWL-08** 8 qt stainless steel bowl
- XXBEAT-08** Aluminum flat beater
- XXBEAT-08SS** Stainless steel flat beater
- XXHOOK-08** Aluminum dough hook
- XXHOOK-08SS** Stainless steel dough hook
- XXWHIP-08** Stainless steel wire whip
- XTable** Stainless steel countertop mixer table with undershelf (30" w x 24" d x 24" h)
- EXTENDED WARRANTY SP-XD58**
Extended warranty for SP8 mixer, extends factory warranty to 3 years. **Available only at time of purchase.**