

Data Sheet | Item Number: 890-1112

Plug; 2-pole; Cod. I; 1,50 mm²; blue

<https://www.wago.com/890-1112>

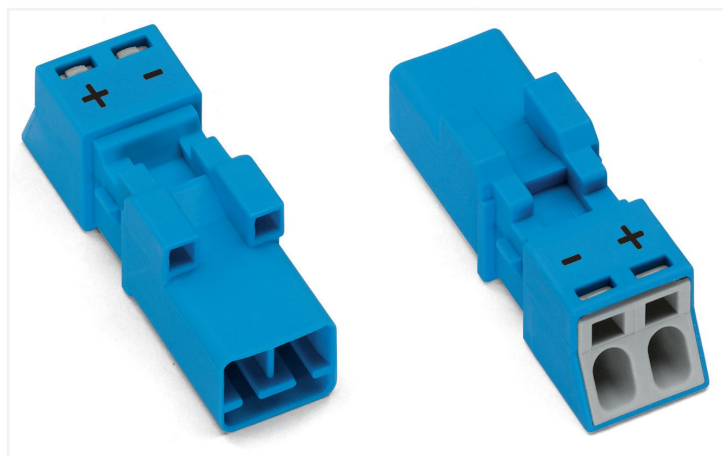

Color: ■ blue

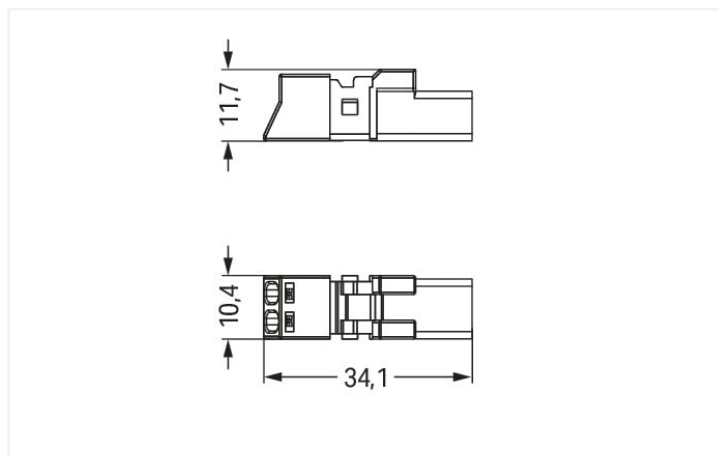

Dimensions in mm

Male connector/plug WINSTA® MINI rated current 16 A

The WINSTA® MINI male connector/plug with protection against mismatching supports rapid, correct installation. On PCBs, in control cabinets or for connecting lights – pluggable installation connectors from WAGO allow you to establish connections according to a huge variety of requirements in no time flat. The coding options reduce installation errors, allowing fast, secure wiring of all components. I coding in blue is used to identify WINSTA® MINI pluggable installation connectors, which are used predominantly in automation of buildings for controlling lighting. Thanks to its particularly compact dimensions, our WINSTA® MINI Pluggable Connection System with Push-in CAGE CLAMP® spring pressure connection technology is specifically suitable in very tight spaces, i.e., for installations when very little room is available.

WINSTA® MINI solutions for your electrical installation – protected against mismatching and maintenance-free

WINSTA® is the pluggable connection system that is ideally tailored to the strict requirements of electrical installation. It allows fast, secure and, above all, error-free installation of components and cables. Now you can also lower installation costs without compromising safety and quality: with protection type IP20 reduces the need for servicing and prevents unnecessary downtime.

- protection against mismatching eliminates errors
- compact design for conductors with a cross-section up to 1.5 mm²
- with I coding for controlling light (DALI standard)
- custom-engineered solutions
- convenient installation and commissioning

Electrical data

Ratings per	IEC/EN 60664-1		
Overvoltage category	III	III	II
Pollution degree	3	2	2
Nominal voltage	250 V	-	-
Rated surge voltage	4 kV	-	-
Rated current	16 A	-	-

Approvals per	UL 1977
Rated voltage	600 V
Rated current	14 A

General information

Note on contact resistance	approx. 1 mΩ of contact resistance approx. 0.25 mΩ contact transition plug/ socket
----------------------------	--

Connection data

Connection points	2	Connection 1	
Total number of potentials	2	Connection technology	Push-in CAGE CLAMP®
		Actuation type	Operating tool Push-in
		Nominal cross-section	1.5 mm ² / 16 AWG
		Solid conductor	0.25 ... 1.5 mm ² / 22 ... 16 AWG
		Solid conductor; push-in termination	0.75 ... 1.5 mm ² / 20 ... 16 AWG
		Stranded conductor	0.25 ... 1 mm ² / 22 ... 18 AWG
		Fine-stranded conductor	0.25 ... 1.5 mm ² / 22 ... 16 AWG
		Fine-stranded conductor; with insulated ferrule	0.25 ... 0.75 mm ² / 22 ... 20 AWG
		Fine-stranded conductor; with uninsulated ferrule	0.25 ... 0.75 mm ² / 22 ... 20 AWG
		Fine-stranded conductor; with ferrule; push-in termination	0.75 mm ² / 20 AWG
		Strip length	9 mm / 0.35 inches
		Pole number	2
		Conductor entry direction to mating direction	0°

Physical data

Pin spacing	4.4 mm / 0.173 inches
Width	10.4 mm / 0.409 inches
Height	11.7 mm / 0.461 inches
Depth	34.1 mm / 1.343 inches

Mechanical data

Application	DALI, Lighting Management
Coding	I
Variable coding	No
Marking	- +
Potential marking	- +
Mating force of a plug-in connection	approx. 20 ... 70 N (depending on pole number)
Retention force of a plug-in connection	Locked: > 80 N
Unmating force of a plug-in connection	Unlocked: approx. 20 ... 70 N (depending on pole number)
Number of mating cycles	200, without resistive load
Protection type	IP20; IP40 when mated with strain relief housing

Plug-in connection

Contact type (pluggable connector)	Male connector/plug
Connector (connection type)	for conductor
Mismating protection	Yes
Note on mismating protection	All WINSTA® components are 100% protected against mismating when: a.) plugging different numbers of poles b.) plugging while rotated 180 c.) plugging while laterally staggered d.) plugging one pole
Locking lever	Can be retrofitted
Locking of plug-in connection	Locking lever
Note on locking system	All connectors for mounted installations (snap-in versions for lighting fixtures or devices, all types of PCB and distribution connectors) are factory-equipped with locking levers to ensure plugs and sockets are securely locked. Additional locking levers are only required for flying leads (plug/socket).

Material data

Note (material data)	Information on material specifications can be found here
Color	blue
Cover color	gray
Material group	I
Insulation material	Polyamide (PA66)
Flammability class per UL94	V0
Clamping spring material	Chrome-nickel spring steel (CrNi)
Contact material	Copper or copper alloy; surface-treated
Contact plating	Tin
Fire load	0.08 MJ
Weight	2.5 g

Environmental requirements

Processing temperature	-5 ... +40 °C
Continuous operating temperature	-35 ... +85 °C
Note on continuous operating temperature	Insulating parts for temperatures ≤ 105 °C

Commercial data

Product Group	20 (Winsta)
eCl@ss 10.0	27-44-06-05
eCl@ss 9.0	27-44-06-05
ETIM 8.0	EC002560
ETIM 7.0	EC002560
PU (SPU)	50 pcs
Packaging type	Box
Country of origin	PL
GTIN	4055143548502
Customs tariff number	85366990990

Environmental Product Compliance

RoHS Compliance Status	Compliant, No Exemption
------------------------	-------------------------

Approvals / Certificates

General approvals



Approval	Standard	Certificate Name
CCA DEKRA Certification B.V.	EN 61535	71-123231
CCA DEKRA Certification B.V.	IEC 61535	NL-85020
cURus Underwriters Laboratories Inc.	UL 1977	E45171

Declarations of conformity and manufacturer's declarations

Approval	Standard	Certificate Name
EU-Declaration of Confor- mity WAGO GmbH & Co. KG	-	-
UK-Declaration of Confor- mity WAGO GmbH & Co. KG	-	-

Approvals for marine applications



Approval	Standard	Certificate Name
ABS American Bureau of Ship- ping	Steel Vessel Rules	19-HG1869855-PDA
DNV GL Det Norske Veritas, Ger- manischer Lloyd	-	TAE00001Z6
LR Lloyds Register	EN 61535	08/20047 (E2)

Downloads

Environmental Product Compliance

Compliance Search
Environmental Product Compliance 890-1112

Documentation

Bid Text			
890-1112	19.02.2019	xml 2.95 KB	
890-1112	08.06.2015	doc 23.00 KB	

CAD/CAE-Data

CAD data
2D/3D Models 890-1112

CAE data
EPLAN Data Portal 890-1112
WSCAD Universe 890-1112
ZUKEN Portal 890-1112

1 Compatible Products

1.1 System counterpart

1.1.1 Cable assembly



Item No.: 891-8982/106-101
pre-assembled connecting cable; Eca;
Socket/open-ended; 2-pole; Cod. I;
H05VV-F 2 x 1.5 mm²; 1 m; 1,50 mm²; blue

Item No.: 891-8982/006-101
pre-assembled interconnecting cable;
Eca; Socket/plug; 2-pole; Cod. I; H05VV-F
2 x 1.5 mm²; 1 m; 1,50 mm²; blue

1.1.2 Distribution box



Item No.: 899-681/146-000

Distribution box; 230 V + DALI; 1 input; 7 outputs; Cod. I; MINI, MIDI; white

Item No.: 899-631/181-000

Distribution box; 230 V + DALI; 2 inputs; 6 outputs; Cod. A, I; MINI, MIDI; black

Item No.: 899-631/455-000

Distribution box; 400 V + DALI; 2 inputs; 5 outputs; Cod. A, I; MINI, MIDI; black

Item No.: 899-681/147-000

Distribution box; 400 V + DALI; 2 inputs; 5 outputs; Cod. A, I; MINI, MIDI; white

1.1.3 Distribution connector



Item No.: 890-1904

3-way distribution connector; 2-pole; Cod. I; 1 input; 3 outputs; blue

Item No.: 890-1907

5-way distribution connector; 2-pole; Cod. I; 1 input; 5 outputs; blue

Item No.: 890-1617

T-distribution connector; 2-pole; Cod. I; 1 input; 2 outputs; 2 locking levers; blue

Item No.: 890-1620

T-distribution connector; 2-pole; Cod. I; 1 input; 2 outputs; 3 locking levers; for flying leads; blue

1.1.4 Female connector/socket



Item No.: 890-2102

Snap-in socket; 2-pole; Cod. I; 1,50 mm²; blue

Item No.: 890-3102/011-000

Socket for PCBs; angled; 2-pole; Cod. I; blue

Item No.: 890-3102

Socket for PCBs; straight; 2-pole; Cod. I; blue

Item No.: 890-1102

Socket; 2-pole; Cod. I; 1,50 mm²; blue

1.2 Required Accessories

1.2.1 Locking system

1.2.1.1 Locking system



Item No.: 890-111

Locking lever; for flying leads; for tool operation; black

Item No.: 890-131

Locking lever; for flying leads; for tool operation; white

Item No.: 890-101

Locking lever; for manual operation; black

Item No.: 890-121

Locking lever; for manual operation; white

1.2.2 Strain relief

1.2.2.1 Strain relief housing



Item No.: 890-502/342-000

Strain relief housing; 2-pole; with locking clip; for 1 cable; 3.8 ... 8.2 mm; 17.5 mm; black

Item No.: 890-512/342-000

Strain relief housing; 2-pole; with locking clip; for 1 cable; 3.8 ... 8.2 mm; 17.5 mm; white

Item No.: 890-502

Strain relief housing; 2-pole; with locking clip; for 1 cable; 3.8 ... 8.2 mm; 30 mm; black

Item No.: 890-512

Strain relief housing; 2-pole; with locking clip; for 1 cable; 3.8 ... 8.2 mm; 30 mm; white

1.3 Optional Accessories

1.3.1 Cover

1.3.1.1 Cover



Item No.: 897-2001

Protective cap; Type1; for sockets and plugs; PVC; red

1.3.2 Installation

1.3.2.1 Mounting accessories



Item No.: 890-310

Mounting carrier; 2- to 5-pole; for flying leads; black



Item No.: 890-311

Mounting carrier; 2- to 5-pole; for flying leads; white

1.3.3 Tool

1.3.3.1 Operating tool



Item No.: 890-382

Operating tool; 2-way; green



Item No.: 210-719

Operating tool; Blade: 2.5 x 0.4 mm; with a partially insulated shaft

Installation Notes

Conductor termination

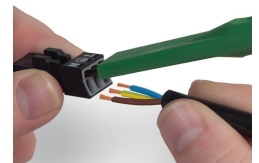
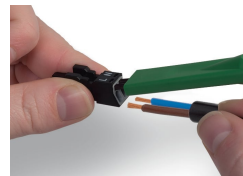
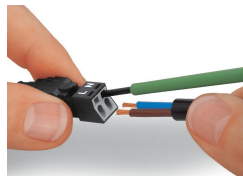

1. Strip length, outer insulation = 30 mm (2-pole), 37 mm (3-pole), 45 mm (4- and 5-pole)
2. Strip length = 9 mm
3. Extended ground conductor = 8 mm

To terminate fine-stranded conductors, open the clamping unit via screwdriver – 2.5 mm blade width – and insert a stripped conductor until it hits the backstop. Terminate solid conductors by simply pushing them in.

To terminate fine-stranded conductors, open clamping units via operating tool (890-382) and insert stripped conductors until they hit backstop. Terminate solid conductors by simply pushing them in.

To terminate fine-stranded conductors, open clamping units via operating tool (890-383) and insert stripped conductors until they hit backstop. Terminate solid conductors by simply pushing them in.

Installation

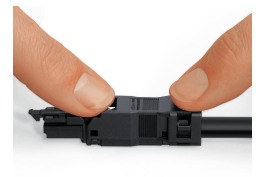
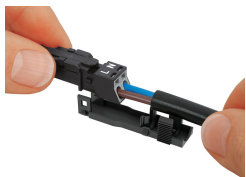

Latch the wired connector into the base of the strain relief housing.

Push down strain relief clamp by hand.

Push down strain relief clamp with 2.5 mm screwdriver alternately on both sides.

Latch the top of the strain relief housing.



The printed marking of the connector is clearly visible in the openings of the strain relief housing.