

# SMART-IN 10 AC2/Z slick

## CONTINUOUS LIGHT LINE IN SMALL RECESSED PROFILE

- suitable for use in plasterboards - does not affect the structure of the board
- used also in furniture
- continuous line of light (when using LED strip 120p/m and opal cover)
- SLICK socket
- miniature dimensions
- maximum width of LED strip: 10 mm



\* Parameters tolerance +/- 7%

- A** slide cover
- C2** click cover  
klosz C2 klik
- Z<sup>1</sup>** Z flexible mounting plate
- Z<sup>2</sup>** coneZ flexible mounting plate

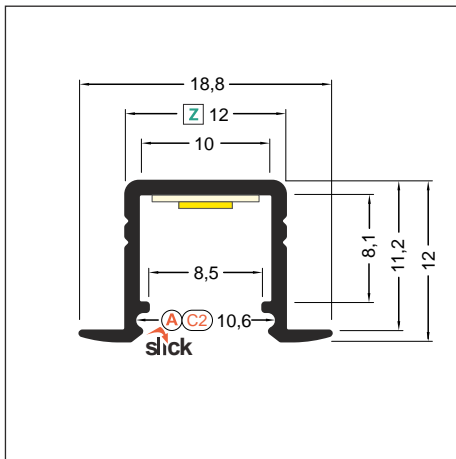
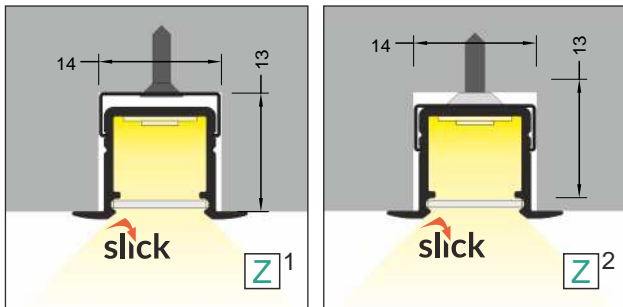
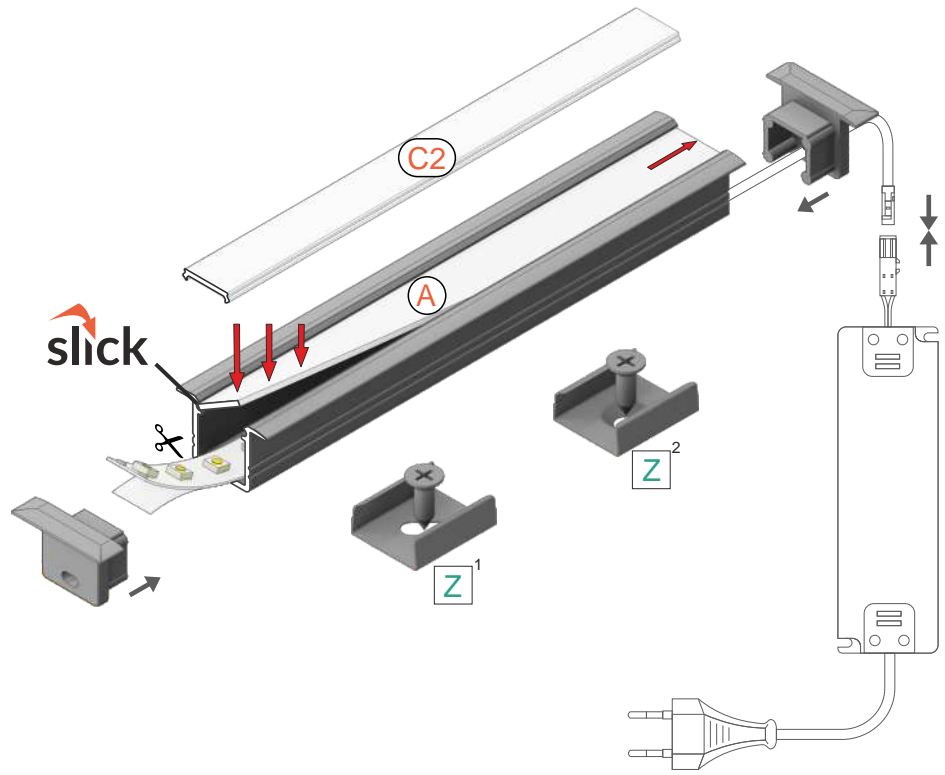

- max 10 mm
- recessed

- length 2000 mm
- white painted
- anodized
- black anodized
- raw aluminium

Available lengths: 1000 mm, 2000 mm, 3000 mm, 4000 mm.  
 The standard profile length tolerance is +20 mm.

\* Parameters tolerance +/- 7%

## COVERS

**A slide cover**  
 colors: transparent, frosted, opal  
 material: PC, PP, PP



**Note!** Dimensions of the space to install LED source

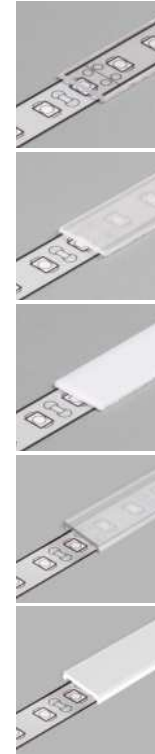
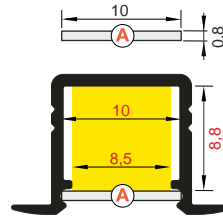

length 2000 mm

A transparent

A frosted

A opal

**C2 click cover**  
 colours: transparent, opal  
 material: PMMA

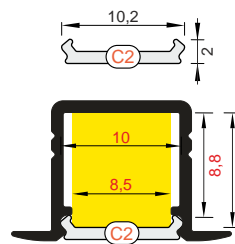

C2 transparent

C2 opal

The standard cover length tolerance is +20 mm.

## ENDINGS / ZA LEPKI

**SMART-IN10 ending with hole**  
 colours: white, silver, black, grey  
 material: ABS

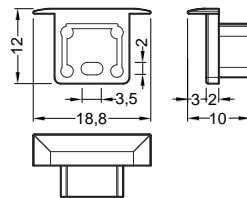

sold in sets of 2 pieces

white

silver

black

grey

## MOUNTINGS

**Z flexible mounting plate**  
 colours: white, inox, black  
 material: stainless steel

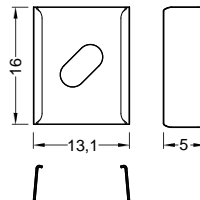
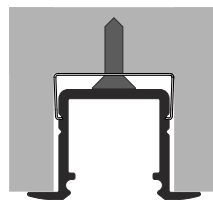

white

stainless steel

black

**Zcone flexible mounting plate**  
 colours: white, inox, black  
 material: stainless steel

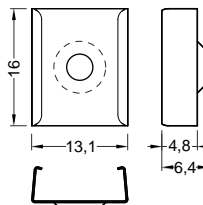
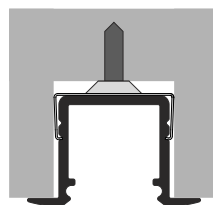

white

stainless steel

black

\* Parameters tolerance +/- 7%



\* Parameters tolerance +/- 7%