

Profile HR-MAX

Ref. A01829

Ref. arch C1829

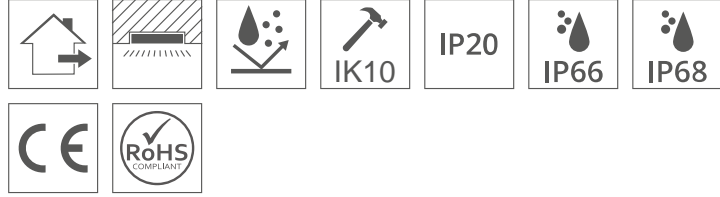

- For indoor/outdoor ground installation
- Designed for IP68 and IK10 protection ratings
- Corrosion resistance at high salinity
- Corresponds to the width of the HR-OPTI facade system

APPLICATION

- warning and decorative lighting

MOUNTING

- in the ground, with mounting adhesive and a dedicated mounting track

ADDITIONAL INFORMATION

- possibility of smooth transition from an in-ground into a facade lighting fixture
- use of clips facilitates the assembly of the lighting fixture
- compatible with a dedicated HR-MAX-T and HR-MAX-TW mounting tracks
- standard lengths of KLU profiles and covers: 1000 mm (tolerance ± 1.5 mm) and 2005 mm / 3010 mm (tolerance + 5 mm); for selected covers: 6050 mm, 10050 mm (tolerance + 5 mm)
- when choosing a different length of profiles / covers than available in the standard, you should additionally choose the cutting service at KLU

TECHNICAL DRAWING

1:2

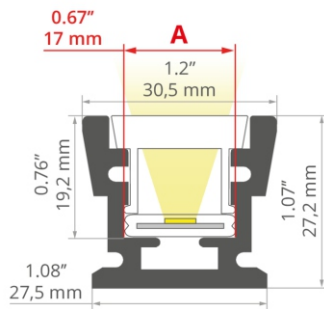

TECHNICAL SPECIFICATIONS

Material	aluminum
Color	silver anodized
Possible fixture IP	20, 66, 68
Profile cross-section	rectangular
Width	30.5 mm
Height	27.2 mm
LED gluing width A	17 mm
Number of LED strips A (8 mm wide)	2
Corrosion resistance at high salinity	yes
Impact protection IK10	yes
Possibility of obtaining a line of light	yes
Building type	Outdoor, Commercial, Retail
Facility zone	communication routes and corridors, driveways, parking gara
The cover is cut to the length of the profile	yes
Wire out back of extrusion	yes

Length	Ref
1000 mm	A01829A_1 C1829ANODA_1
2005 mm	A01829A_2 C1829ANODA_2
3010 mm	A01829A_3 C1829ANODA_3

Wired 4 Signs USA
+1 (865) 339 4956
info@w4susa.com
7669 Clinton Highway,
Powell, Tennessee,
37849

DISTRIBUTED BY



Profile HR-MAX

Ref. A01829

Ref. arch C1829

SAMPLE PROJECTS



RELATED PROFILES > MOUNTING TRACKS



HR-MAX-T
A01827
Ref. arch C1827



HR-MAX-TW
A01828
Ref. arch C1828

RELATED ACCESSORIES > RELATED COVERS

NAME	MATERIAL	MATERIAL TRANSMITTANCE	COLOR	REF.
HR-21	PMMA	45 %	<input type="checkbox"/> frosted	B17152M 17152

RELATED ACCESSORIES > RELATED END CAPS

NAME	MATERIAL	COLOR	REF.
HR-MAX-STN NEW	stainless steel	<input checked="" type="checkbox"/> silver	C28020N00 24388

RELATED ACCESSORIES > RELATED LED > COLOR MONO

Wired 4 Signs USA
+1 (865) 339 4956
info@w4susa.com
7669 Clinton Highway,
Powell, Tennessee,
37849

DISTRIBUTED BY



Profile HR-MAX

Ref. A01829

Ref. arch C1829

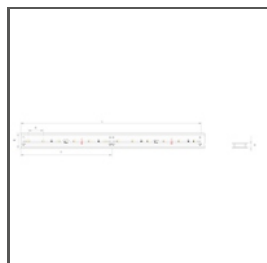

14K-WP-K-BLUE-1220-24V

KWP-14KBLUE-1220-24
Ref. arch 14KWPBLUE122024V

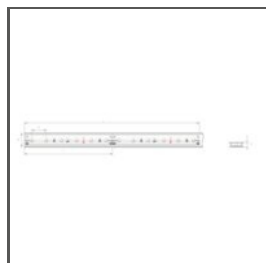

14-K-WP-K-BLUE-1210-24V

KWP-14KBLUE-1210-24
Ref. arch 14KWPBLUE121024V

RELATED ACCESSORIES > RELATED LED > RGB / RGB-W / RGB-CTT

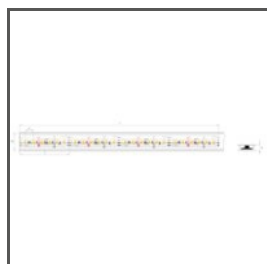

14K-WP-K-RGB-0700-24V

KWP-14KRGB-0700-24
Ref. arch 14K-WP-K-RGB-0700-24V

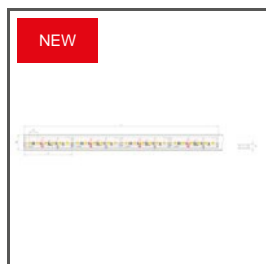

14K-WP-K-RGB-1200-24V

KWP-14KRGB-1200-24
Ref. arch 14K-WP-K-RGB-1200-24V

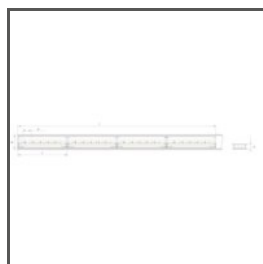

14K-WP-K-1530-RGB+W-24V

KWP-14KRGBW-1530-24
Ref. arch 14KWP1530RGB+W24V

RELATED ACCESSORIES > RELATED LED > WHITE MONO



14K-WP-K-0480-24V

KWP-14K-0480-24
Ref. arch 14K-WP-K-0480-24V



14K-WP-K-0960-24V

KWP-14K-0960-24
Ref. arch 14K-WP-K-0960-24V



14K-WP-K-1440-24V

KWP-14K-1440-24
Ref. arch 14K-WP-K-1440-24V

RELATED ACCESSORIES > OTHER RELATED ACCESSORIES > ADDITIONAL ITEMS

Wired 4 Signs USA
+1 (865) 339 4956
info@w4susa.com
7669 Clinton Highway,
Powell, Tennessee,
37849

DISTRIBUTED BY



Profile HR-MAX

Ref. A01829

Ref. arch C1829

KLUŚ Inspiring
Solutions



PIANKA
HR-MAX
Z70547
Ref. arch 70547

RELATED ACCESSORIES > OTHER RELATED ACCESSORIES > OTHER



HERMETIC COUPLER
C28239C02
Ref. arch 42702



GLAND
M16x1,5
C42271C02
Ref. arch 42271



ANGULAR GLAND
M16x1,5-L90
C28158C02
Ref. arch 42289

Wired 4 Signs USA
+1 (865) 339 4956
info@w4susa.com
7669 Clinton Highway,
Powell, Tennessee,
37849

DISTRIBUTED BY

