

FLAT8

- flat recessed profile emitting di used light glow
- decorative illumination
- a parabolic, reflecting element – even, smooth, di used light
- a flat profile, designed to fit into plasterboards – installation without interference in the frame construction
- mounted to furniture, walls, pedestals with holders (click-in) or directly (with screws, adhesive tape or glue)



max 8 mm



recessed



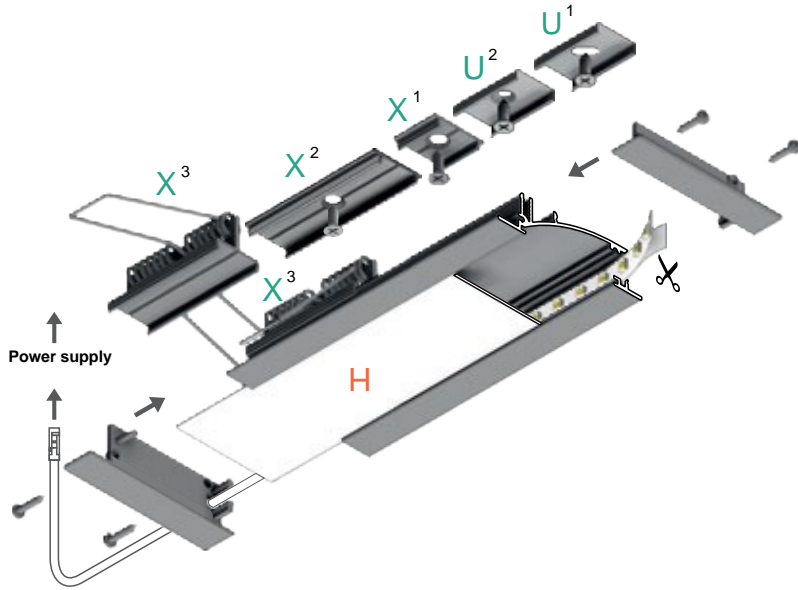
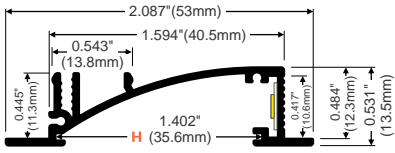

Standard length 2000 mm
Other lengths available

U¹
U flexible mounting plate

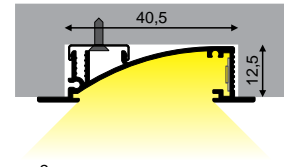

U²
Cone U flexible mounting plate

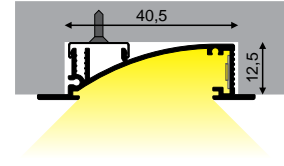

X¹
X mounting plate

X²
X connector 180 deg

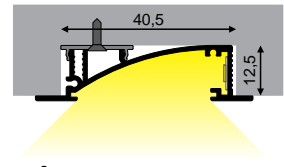

X³
Spring X mounting plate

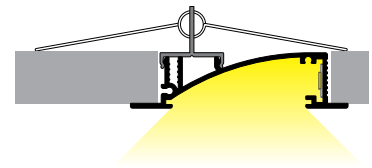

H
H slide di user

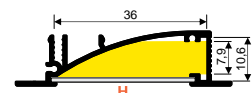

FLAT8 end cap with hole
material: ABS

- White
LED-23110001
- Silver
LED-23110002
- Black
LED-23110040
- Grey
LED-23110022



* Parameters tolerance +/- 7%