



FEATURES

- ◆ SERVER GATEWAY
- ◆ POWER INPUT: 12-24-48 Vdc
- ◆ ETHERNET BUS: 10/100Mbit
- ◆ MODBUS BUS: range baud rate 9600 – 250000
- ◆ DMX BUS: 1 universe DMX512
- ◆ DALI BUS: 1 DALI line – integrated DALI bus power supply

→ For the always updated manual, consult our website: www.dalcnet.com or the QR on the product



TECHNICAL SPECIFICATIONS

		DGM02-1248		
Supply voltage		12 / 24 / 48 Vdc		
Input current		550mA max		
Nominal Power¹		typ		max
	@12V	160 mA (1.92W)		550 mA (6.60W)
	@24V	80 mA (1.92W)		260 mA (6.24W)
	@48V	50 mA (2.40W)		150 mA (7.20W)
PoE¹		min ²	typ	max
	@48V	40 mA (1.9W)	100 mA (4.65W)	170 mA (7.9W)
ETHERNET		10 / 100 Mbit baseT FULL DUPLEX AUTO NEGOTIATION		
MODBUS RTU		RS-485, BAUD RATE da 9600 a 250000		
DMX		512 CHANNELS		
DALI		64 ADDRESS Integrated power supply: 200mA / 16Vdc		Guaranteed bus current = 200mA Max bus current = 250mA
Storage temperature		Min: -40°C ÷ Max +60°C		
Ambient temperature		Min: -40°C ÷ Max +60°C		
Casing material		Plastic		
Packaging units (pieces/units)		1pz		
Mechanical dimensions		72 x 92 x 62 mm		
Package dimensions		85 x 124 x 71 mm		
Weight		100g		

¹ Values may differ by ± 5%

² Only with BUS 3 config in NOT USE

REFERENCE STANDARDS

EN 55035	Electromagnetic compatibility of multimedia equipment - Immunity Requirements
EN 55032	Electromagnetic compatibility of multimedia equipment - Emission Requirements
EN IEC 62368-1	Audio/video, information and communication technology equipment - Part 1: Safety requirements
EN IEC 62368-1/A11	Audio/video, information and communication technology equipment - Part 1: Safety requirements
EN IEC 62368-1/AC	Audio/video, information and communication technology equipment - Part 1: Safety requirements
IEC 62386-101 ED.2	Digital addressable lighting interface – Part 101: General requirement – System components
IEC 62386-103 ED.2	Digital addressable lighting interface – Part 103: General requirements – Control devices
IEC 62386-205 ED.2³	Digital addressable lighting interface – Part 205: Particular requirements for control gear – Supply voltage controller for incandescent lamps (device type 4)
IEC 62386-207 ED.2⁴	Digital addressable lighting interface – Part 207: Particular requirements for control gear – LED modules (device type 6)
IEC 62386-209 ED.2⁵	Digital addressable lighting interface – Part 209: Particular requirements for control gear – Colour control (device type 8)
ANSI E1.11	Entertainment Technology – USITT DMX512-A Asynchronous Serial Digital Data Transmission Standard for Controlling Lighting Equipment and Accessories
-	MODBUS APPLICATION PROTOCOL SPECIFICATION V1.1b

³ Il DGM02 set commands for control gear DT4, compatible with the standard IEC 62386-205

⁴ Il DGM02 set commands for control gear DT6, compatible with the standard IEC 62386-207

⁵ Il DGM02 set commands for control gear DT8, compatible with the standard IEC 62386-208 (colour type Tc, colour type RGBWAF)

WIRING DIAGRAM

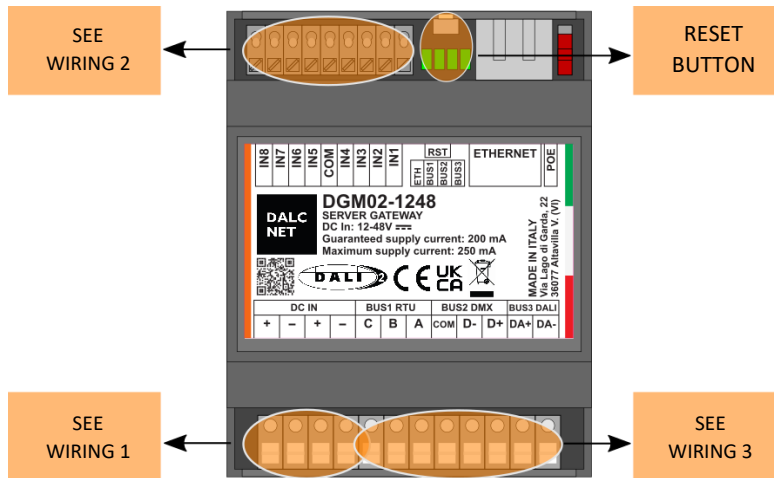

WIRING 1

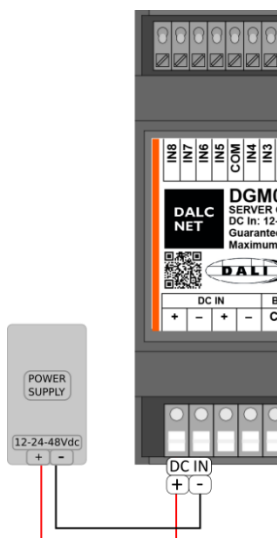

WARNING:

Always remove the main power supply (230Vac) during installation or maintenance of the product. Do not connect or disconnect power supplies to DC IN terminals if the Power Supply is powered on. If the product is powered by PoE make sure that the PSE (Power Sourcing Equipment) is disconnected. Do not connect or disconnect power supplies via PoE if the PSE is powered on.

WIRING 2

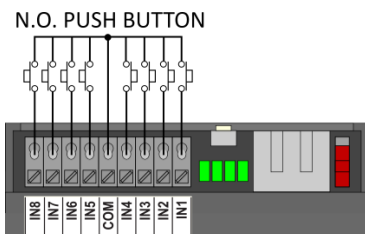

WIRING 3

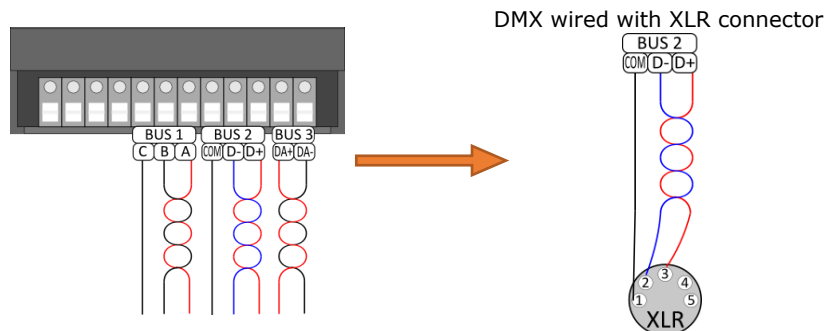

PINOUT CONNECTORS

PIN OUT PLUG-IN CONNECTORS			
1	DC IN		Vin+
2			Vin-
3			Vin+
4			Vin-
5	Modbus 1	C	COM
6		B	DMX 1 D-
7	Modbus 2	A	DMX 1 D+
8		C	COM
9	Modbus 2	B	DMX 2 D-
10		A	DMX 2 D+
11	DALI		DA+
12			DA-

PIN	RJ45 / A (RJ45 / B crossed)	RJ45 / B (RJ45 / A crossed)
1	White / Green	White / Orange
2	Green	Orange
3	White / Orange	White / Green
4	Blue	Blue
5	White / Blue	White / Blue
6	Orange	Green
7	White / Brown	White / Brown
8	Brown	Brown

ONBOARD LED

LED	FUNCTION	ON	BLINK	OFF
LED1 (First from left)	Ethernet	Wired and communicating via ethernet	Wired with ethernet	Not wired
LED2	BUS1(RTU/ DMX)	Connected with communication	Connected with no communication (only RTU)	BUS1 not enabled
LED3	BUS2(DMX/RTU)	Connected with communication	Connected with no communication (only RTU)	BUS2 not enabled
LED4 (First from right)	BUS DALI	Connected with communication	Connected with no communication	DALI BUS not enabled. BUS power off

RESET BUTTON

Device Restart: Press the reset button for less than 2 seconds.

Factory settings: Press the reset button for more than 2 seconds, all 4 signaling LEDs must light up progressively from right to left.

POWER OVER ETHERNET (POE)

The device is able to operate also with PoE power supply.
To enable this power supply, simply move the PoE selector upwards.

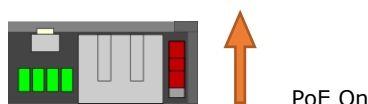

NOTE: Before connecting the device to a PoE switch or injector, disconnect any other power sources from the DC IN + and DC IN- terminals.

TECHNICAL NOTE

INSTALLATION:

- CAUTION: The product may only be connected and installed by qualified personnel. All applicable regulations, legislation, and building codes in force in the respective countries must be observed. Incorrect installation of the product can cause irreparable damage to the product and the connected LEDs.
- The product must be installed inside a switchgear/controlgear cabinet and/or junction box protection against overvoltage.
- The product must be installed in a vertical or horizontal position with the label/top cover facing upwards or vertically. Other positions are not permitted. The bottom position is not permitted (label/top cover facing down).
- Keep separated 230Vac (LV) circuits and not SELV circuit from safety extra low voltage (SELV) circuit and from any connection with this product. It is absolutely forbidden to connect, for any reason whatsoever, directly or indirectly, the 230Vac mains voltage to the product (terminal block of BUS included).
- The product must be dissipated correctly.
- The use of the product in harsh environments could limit the output power.
- If the cables cause radiation noise, install a ferrite core on the ethernet cable by making 2 turns. It is recommended to use a ferrite with the following characteristics: Würth 74271622.
- Maintenance must be performed only by a qualified electrician in compliance with current regulations.

POWER SUPPLY

- Use only SELV power supplies with limited current for device power supply, short circuit protection and the power must be dimensioned correctly.
In the case of power supplies equipped with ground terminals, it is mandatory to connect ALL protective ground points (PE= Protection Earth) to a properly and certified protection earth.
- It is recommended to use a power supply with limited power source "LPS" <15W. It is recommended to use HDR-15-12 power supply.
- The connection cables between the very low voltage power source and the product must be properly dimensioned and must be insulated from any wiring or part at non-SELV voltage. It is recommended not to exceed 10m of connection between the power supply and the product. Use double insulated cables.
- Dimension the power of the power supply in relation to absorption of device. In case the power supply is oversized compared to the maximum absorbed current, insert a protection against over-current between the power supply and the device.
- Always remove the main power supply (230Vac) during installation or maintenance of the product. Do not connect or disconnect power supplies to DC IN terminals if the Power Supply is powered on.
If the product is powered by PoE make sure that the PSE (Power Sourcing Equipment) is disconnected. Do not connect or disconnect power supplies via PoE if the PSE is powered on.

COMMAND

- The length of the cables connecting between the local commands (N.O. Push button, 0-10V, 1-10V, Potentiometer or other) and the product must be less than 10m. The cables must be properly dimensioned and must be insulated from any non-SELV wiring or voltage. It is recommended to use double insulated cables, if deemed appropriate also shielded.
- The length and type of cables connecting to the bus (DMX, Modbus, DALI, Ethernet or other) must comply with the specifications of the respective protocols and the regulations in force. They must be insulated from any non-SELV wiring or voltage parts. It is recommended to use double insulated cables.
- ALL device and control signal connected to the local command "N.O. Push button", they must not supply any type of voltage.
- ALL device and control signal connect at the BUS (DMX512, Modbus, DALI, Ethernet or other) and to the local command (N.O. Push button or other) must be SELV type (the device connected must be SELV or supply SELV signal).
- All wiring to and from the product must come from inside the installation building. It is not allowed to connect wiring from outside the installation building to the product.

SUMMARY SERVER GATEWAY

SERVER GATEWAY	7
HOME PAGE	8
Device info	8
web side led info	8
WEB INTERFACE	9
SECTION: CHANNEL	10
SECTION: BUS CONFIGURATION	11
Bus 1	11
Bus 2	11
Bus 3	12
SECTION: DALI GLOBAL SETTINGS – BUS 3.....	13
SETTINGS: DALI CONFIG – BUS 3	14
Addressing.....	14
Identification of addressed devices	14
Address change from the devices already addressed	15
Associating a group with a dali address	15
Removing a group	16
State of the dali node.....	16
DALI CONTROLLER – BUS 3	17
DMX512 GLOBAL SETTINGS & RS485 – DMX MASTER (BUS 1 & BUS 2).....	18
DMX512 GLOBAL SETTINGS & RS485 – DMX SLAVE (BUS 1 & BUS 2)	19
MODBUS MASTER & RS485 – MODBUS RTU MASTER (BUS 1 & BUS 2)	20
MODBUS SLAVE & RS485 – MODBUS RTU SLAVE (BUS 1 & BUS 2)	21
SECTION: DIAGNOSTIC – LOG	22
SECTION: DIAGNOSTIC – LOG CONFIGURATION	22
NETWORK	23
LOGIN INFO	24
Edit credentials, procedure:	24
FIRMWARE updates.....	25
Firmware upload, procedure:	25
sACN (ETHERNET).....	26
TCP TELNET (ETHERNET)	27
Data level.....	27
Power-on: Default levels	28
Query dali device type.....	28
Set rgbwaf dali dt8 colour levels.....	28
Query rgbwaf dali dt8 colour levels	29
Set color tc level	29
Query color tc levels	30
Fade engine	30
ART-NET 4 (ETHERNET)	31
Implemented packet	31
MODBUS TCP (ETHERNET)	32
Implemented packet	32



SERVER GATEWAY

The DGM02 device converts information between multiple protocols in real time. It is able to acquire information from the ethernet network and from one or more buses (configured as reception buses), transmitting and converting them to the ethernet network and the buses configured as transmission.

The 512 channels of the buffer are transmitted entirely on the DMX512A bus.

On the DALI bus the first 64 channels of the buffer are transmitted as 64 short addresses, or the first 16 channels as 16 group addresses, or 1 channel as broadcast, only to the nodes that change value.

It is also possible to control DALI DT4 / DT6 / DT8-RGBW / DT8-TW devices through specific Telnet commands.

The first 480 channels of the buffer are transmitted on the MODBUS RTU bus to 80 Modbus devices (ID 1..80) of 6 registers each. Through any control unit that has an Ethernet connection it becomes possible to control a total of 512 levels of light intensity and to control different devices (DMX512A, DALI, MODBUS) without having to know in detail the operation of the relative protocols.

HOME PAGE

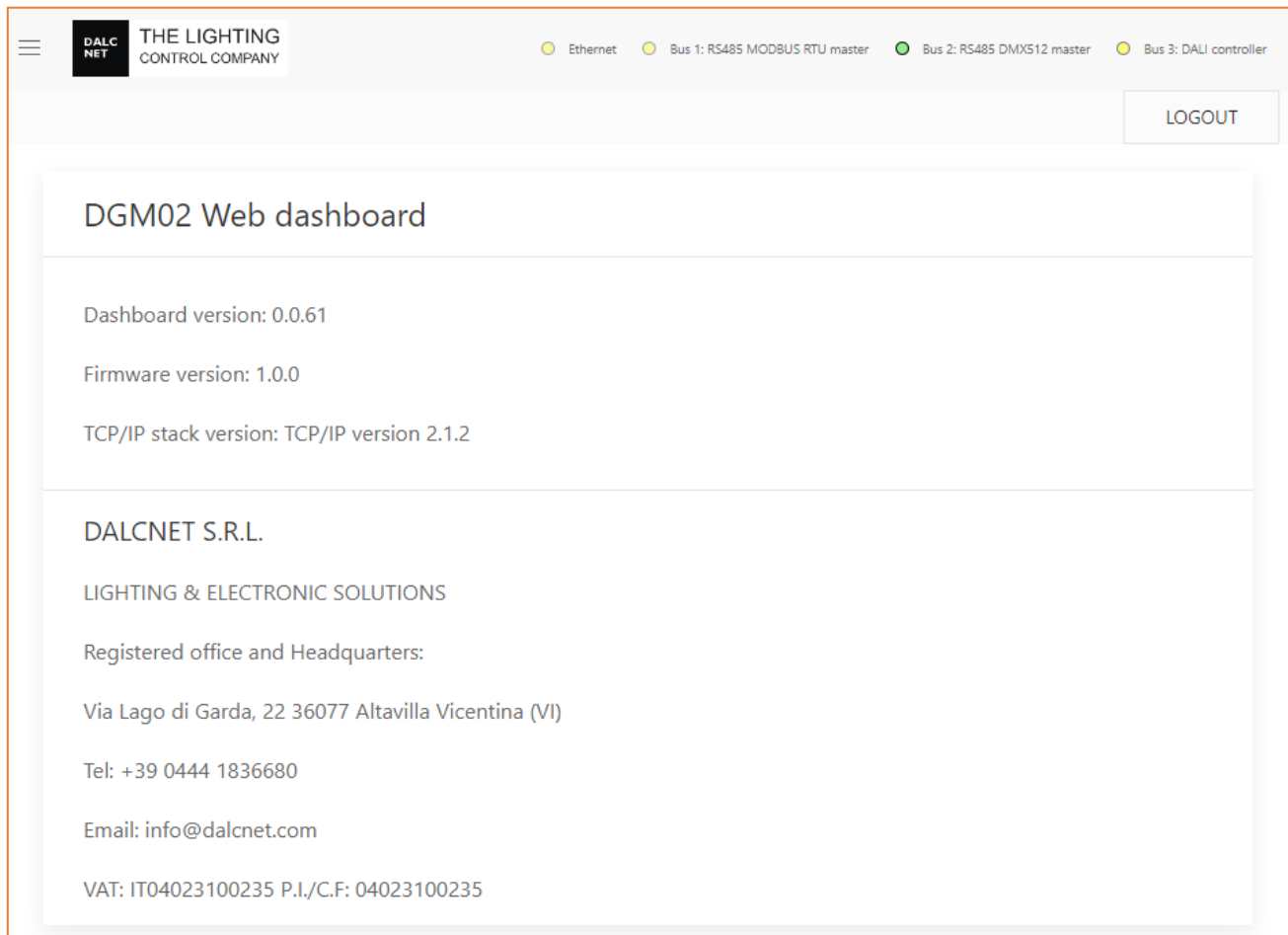

The screenshot shows the DGM02 Web dashboard interface. At the top left, there is a menu icon and the DALCNET logo. The main header area includes the text 'THE LIGHTING CONTROL COMPANY' and a status bar with four indicators: Ethernet (yellow), Bus 1: RS485 MODBUS RTU master (yellow), Bus 2: RS485 DMX512 master (green), and Bus 3: DALI controller (yellow). A 'LOGOUT' button is located in the top right corner. The main content area is titled 'DGM02 Web dashboard' and contains the following information:

- Dashboard version: 0.0.61
- Firmware version: 1.0.0
- TCP/IP stack version: TCP/IP version 2.1.2

Below this, the company information for DALCNET S.R.L. is displayed:

- LIGHTING & ELECTRONIC SOLUTIONS
- Registered office and Headquarters:
Via Lago di Garda, 22 36077 Altavilla Vicentina (VI)
- Tel: +39 0444 1836680
- Email: info@dalcnet.com
- VAT: IT04023100235 P.I./C.F: 04023100235

DEVICE INFO

In the "HOME" screen it is possible to view the information of the device in use such as: Dashboard version, Firmware version, TCP / IP stack version.

On this page you can select the following sections:

- ◆ LOGOUT, to exit the Web Server of the device in use.
- ◆ MENU ', by clicking on the pop-up menu you can access the device configuration pages.
 - BUS section: this section contains the pages for managing protocols, such as DALI, DMX and MODBUS, and managing the devices connected to the DALI network;
 - SETTINGS Section: this section contains the pages for configuring the IP address and for setting up the network and BUS protocols.

WEB SIDE LED INFO

- ◆ STEADY GREEN: communication is active
- ◆ BLINKING YELLOW: no communication via BUS or BUS not activated

WEB INTERFACE

For supervision and configuration, the Gateway provides a web interface accessible via a browser at the IP address of the device (default IP 192.168.1.4).

By clicking on the top menu, you can view the device settings (accessible only to Admin users):

- ◆ **Channels:** in this page it is possible to configure the dimming values of the channels with the relative fader (not visible if in DALI CONFIG mode);
- ◆ **Bus Configuration:** in this page it is possible to configure the settings for each single physical bus on the DGM02;
- ◆ **Dali global settings:** in this page it is possible to configure the settings for the DALI bus (modifiable only if in DALI CONFIG mode);
- ◆ **DALI Config:** on this page you can configure the DALI devices, address them and assign membership to groups (not visible if in DALI CONTROLLER mode);
- ◆ **DALI controller:** on this page it is only possible to view the addressed DALI devices and their belonging to the groups (not visible if in DALI CONFIG mode);
- ◆ **DMX512 Global Settings:** in this page it is possible to configure the DMX512 timing settings (not visible if in DALI CONFIG mode or RS485 Bus not enabled);
- ◆ **RS485:** on this page you can configure the settings for the sending speed of the RS485 packet (not visible if in DALI CONFIG mode or RS485 Bus not enabled);
- ◆ **MODBUS Master:** on this page you can configure the settings for sending the master MODBUS RTU packet (not visible if in DALI CONFIG mode or if the master MODBUS RTU BUS is not enabled);
- ◆ **MODBUS Slave:** on this page you can configure the settings for sending the MODBUS RTU slave packet (not visible if in DALI CONFIG mode or if the MODBUS RTU slave BUS is not enabled);
- ◆ **Network:** on this page you can configure the settings to change and manage the IP address, the Netmask and view the MAC Address;
- ◆ **Login Settings:** on this page it is possible to configure the settings for modifying and managing the LOGIN USER and PASSWORD;
- ◆ **sACN:** on this page you can configure the settings for enabling or disabling the protocol;
- ◆ **Telnet:** on this page you can configure the settings for enabling or disabling the protocol and sending times;
- ◆ **ARTNet:** on this page you can configure the settings for enabling or disabling the protocol;
- ◆ **MODBUS TCP Slave:** on this page you can configure the settings for enabling or disabling the protocol;
- ◆ **Firmware Update:** on this page it is possible to configure how the device Firmware is updated;
- ◆ **Log:** the product logs are stored on this page;
- ◆ **Log Configuration:** on this page you can configure the settings for managing the LOGs.

DGM02

Channels

BUS

Bus configuration

DALI global settings

DALI controller

DMX512 global settings

RS485

MODBUS master

SETTINGS

Network

Login settings

sACN

Telnet

ARTNet

MODBUS TCP slave

Firmware update

DIAGNOSTIC

Log

Log configuration

SECTION: CHANNEL

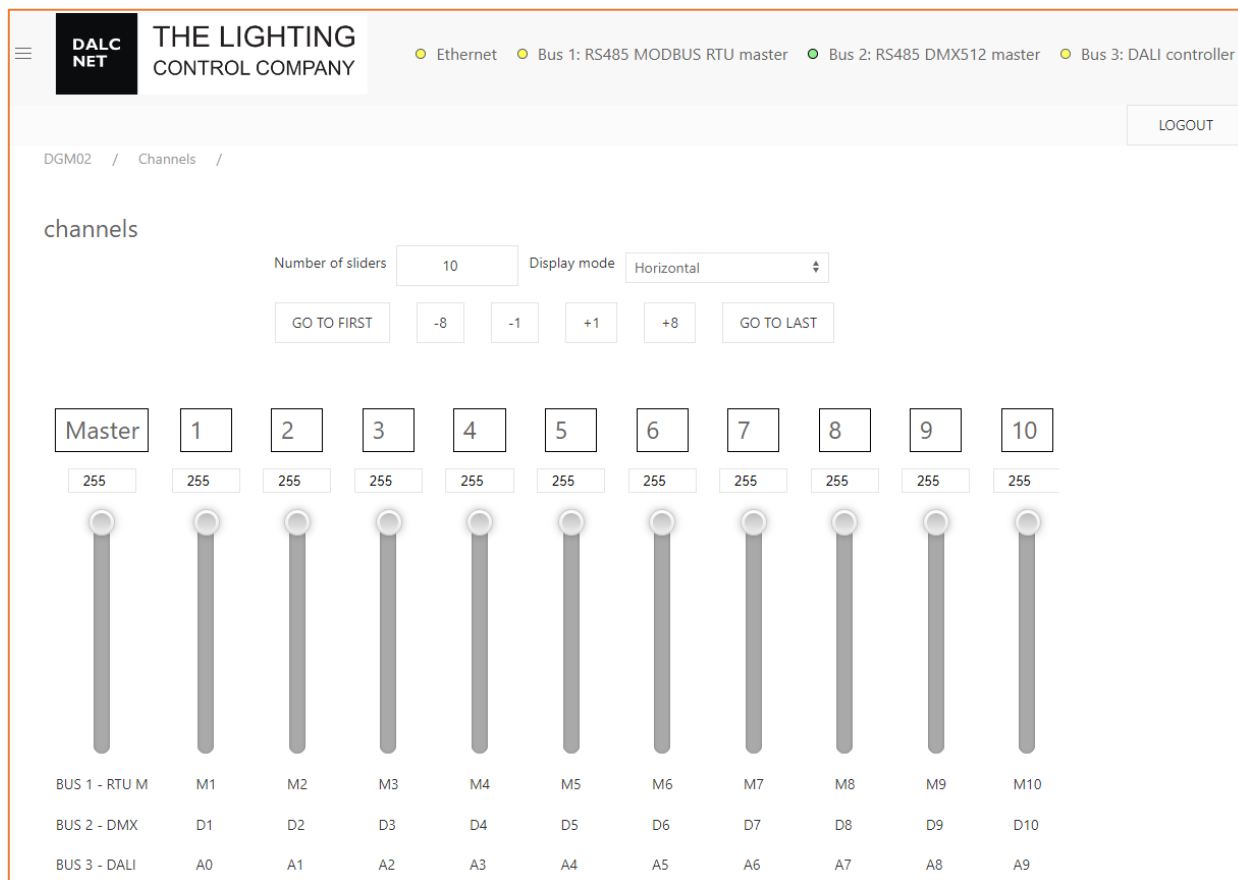

The DGM02 has a WebApp for the supervision and regulation of all the channels available in the various DALI, DMX, MODBUS protocols, which can be used from any device equipped with a compatible browser.

By default, a window for managing 16 channels is displayed. Using the "NUMBER OF SLIDERS" icon you can choose how many channels to see in a single screen (no more than 200) and, thanks to the "DISPLAY MODE" icon, organize the slides of the channels horizontally or vertically.

It is also possible to scroll through all 512 available channels by clicking on the "GO TO FIRST", "GO TO LAST" buttons or by advancing one or eight channels at a time by clicking on the "+1" or "+8" icons. The same is true if you want to go back one or eight channels at a time by clicking on the icons "-1" or "-8"

Thanks to the "MASTER" slide it is possible to set all the channels to the same dimming value.

This graphic allows you to view under each slider whether or not it belongs to one of the three available buses with relative offset and set range (for more information see "BUS CONFIGURATION").

NOTE: To use the available services and applications correctly, it is necessary to use a browser compatible with the technologies: CSS-3, JS, XHR, CORS, JSON, ArrayBuffer.

Compatible browsers are: Microsoft Edge v. 16, Google Chrome v. 66, Mozilla Firefox v. 57, Safari v. 12.1, Opera v. 53 or higher.

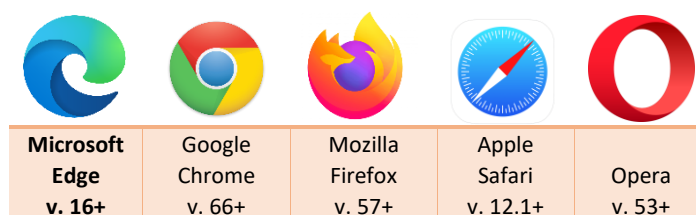

SECTION: BUS CONFIGURATION

BUS 1

Bus 1

Mute

Bus type
RS485 MODBUS RTU master

Offset
1

Channels range
480

BUS 1 is related to the first RS485 port.

You can set this port in the following configurations:

- ◆ Not Set
- ◆ RS485 MODBUS RTU master
- ◆ RS485 MODBUS RTU slave
- ◆ DMX512 master
- ◆ DMX512 slave

In this menu it is possible to assign the "OFFSET" and the "CHANNELS RANGE" to the BUS 1 channels.

The OFFSET allows you to assign the number of the starting slide to the first channel of BUS 1.

The CHANGE RANGE allows you to set the number of channels you want to use in BUS 1.

The BUS can be disabled by means of the "MUTE" flag or by setting the bus configuration in "NOT SET".

BUS 2

Bus 2

Mute

Bus type
DMX512 master

Offset
1

Channels range
512

BUS 2 is related to the second RS485 port.

You can set this port in the following configurations:

- ◆ Not Set
- ◆ RS485 MODBUS RTU master
- ◆ RS485 MODBUS RTU slave
- ◆ DMX512 master
- ◆ DMX512 slave

In this menu it is possible to assign the "OFFSET" and the "CHANNELS RANGE" to the BUS 2 channels.

The OFFSET allows you to assign the number of the starting slide to the first channel of BUS 2.

The CHANGE RANGE allows you to set the number of channels you want to use in BUS 2.

The BUS can be disabled by means of the "MUTE" flag or by setting the bus configuration in "NOT SET".

BUS 3

Bus 3

Mute

Bus type

DALI controller

DALI channels offset

1

DALI channels range

64

Bus 3 is related to the third BUS port of the product. The DALI protocols.

You can set this port in the following configurations:

- ◆ Not Set
- ◆ DALI controller
- ◆ DALI config

In this menu it is possible to assign the "OFFSET" and "CHANNELS RANGE" of the 64 DALI nodes to the BUS 3 channels.

The "DALI channels offset" allows you to assign the number of the starting slide to the first DALI address.

The "DALI channels range" allows you to set the number of channels you want to use in BUS 3.

The BUS can be disabled by means of the "MUTE" flag or by setting the bus configuration in "NOT SET". With these functions you disable the bus and turn off the power supply on the DALI bus.

NOTE: when addressing DALI devices in DALI config mode, it is recommended to set the range to 64, maximum value and only after returning to the DALI Controller configuration and addressing the devices change the range to the desired value.

After modifying the settings, click on the "**APPLY**" button at the top right, otherwise the changes will be lost. On the other hand, with the "**CLEAR**" button the changes are cancelled.

SECTION: DALI GLOBAL SETTINGS – BUS 3

Only in Dali config mode it is possible to send and modify the commands of the DALI global settings pop-up menu which are:

- ◆ **“TRANSMIT AS”:**
 - **“Address”:** send address commands
 - **“Group”:** send group commands
 - **“Broadcast”:** send broadcast commands
- ◆ **“SEND COMMAND OFF INSTEAD OF DAPC0”:** sends the DALI OFF command instead of the DAPC command to 0;
- ◆ **“SYSTEM FAILURE LEVEL ”:** send the System Failure Level command in broadcast;
- ◆ **“POWER ON LEVEL ”:** sends the Power On Level command in broadcast;
- ◆ **“FADE TIME ”:** sends the Set Fade Time command in broadcast;
- ◆ **“DT8 MANAGEMENT ”:** enables the management of DT8s;
- ◆ **“SYSTEM FAILURE COLOR ”:** sends the System Failure Colour command for RGBW components;
- ◆ **“POWER ON COLOR ”:** sends the Power On Colour command for RGBW components;

Transmit as:

address

Send command "OFF" instead of "DAPC 0"

SystemFailureLevel

255

PowerOnLevel

255

Fade time

<0.7s

DT8 management

SystemFailureColor

R 0 G 0 B 0 W 0

PowerOnColor

R 0 G 0 B 0 W 0

NOTE:

Only by pressing “APPLY” are the DALI commands sent.

To unlock the configuration of the other buses, put the DALI bus in DALI Controller mode.

SETTINGS: DALI CONFIG – BUS 3

NOTE: before proceeding with the addressing and configuration of the DALI devices, it is necessary to set BUS 3 in DALI Config mode.

ADDRESSING

By clicking on "DALI config" from the pop-up menu, we enter the DALI device addressing interface.

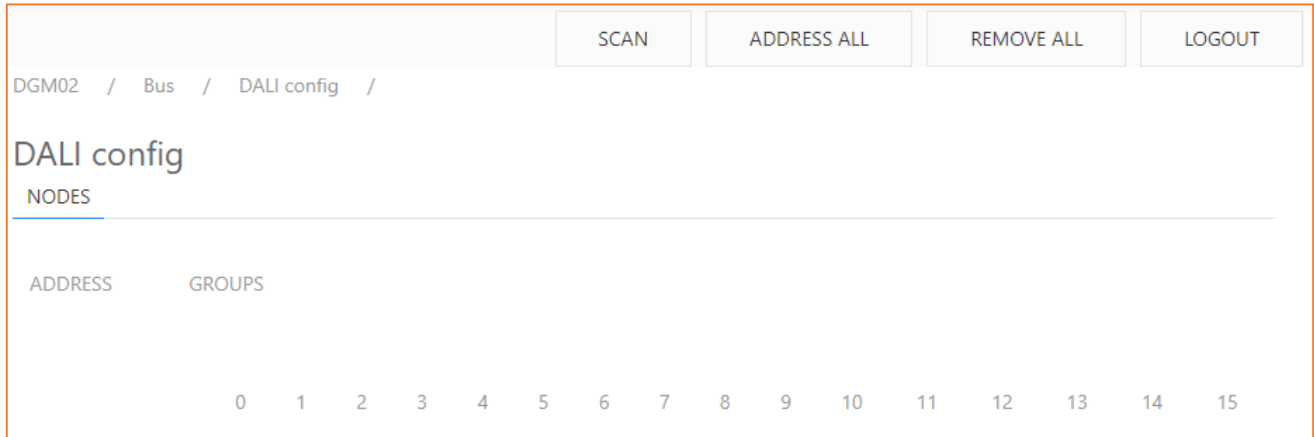

At the top right are the following commands:

- ◆ **"SCAN"**: performs the acquisition of DALI nodes already addressed;
- ◆ **"ADDRESS ALL"**: performs the addressing of all DALI nodes, the address devices will be displayed in a list;
- ◆ **"REMOVE ALL"**: removes the addressing to all DALI nodes.

NOTE: before making a complete addressing of the system it is necessary to send a "REMOVE ALL" command.

IDENTIFICATION OF ADDRESSED DEVICES

After addressing, it is possible to flash the node just addressed, so that it can be visually identified.

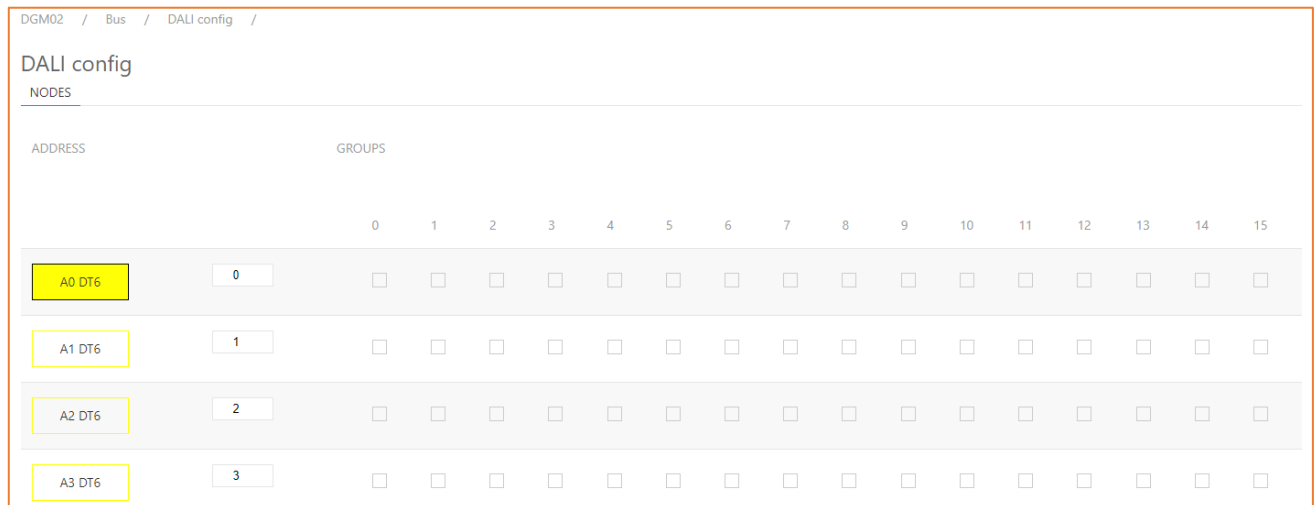

ADDRESS CHANGE FROM THE DEVICES ALREADY ADDRESSED

To change the address of the single DALI node, previously addressed, it is necessary to enter the new node value (eg from 0 to 63) to the right of the flashing button of the node itself and click the "APPLY" button which will appear immediately on the right.

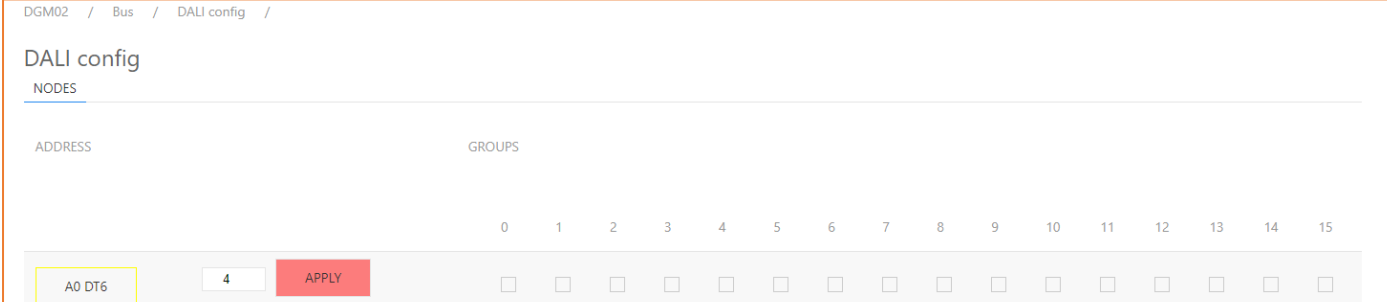

The screenshot shows the 'DALI config' interface with the 'NODES' tab selected. The 'ADDRESS' field is set to 'A0 DT6'. The 'GROUPS' field is set to '4'. A red 'APPLY' button is visible to the right of the 'GROUPS' field. Below the 'GROUPS' field, there are 16 checkboxes labeled 0 through 15, all of which are currently unchecked.

ASSOCIATING A GROUP WITH A DALI ADDRESS

By clicking on one of the 16 boxes depicting the available groups (ie from 0 to 15) it is possible to associate the desired address to a DALI Group. Subsequently, by pressing the "APPLY" button that appears at the top, the command is sent on the DALI BUS.

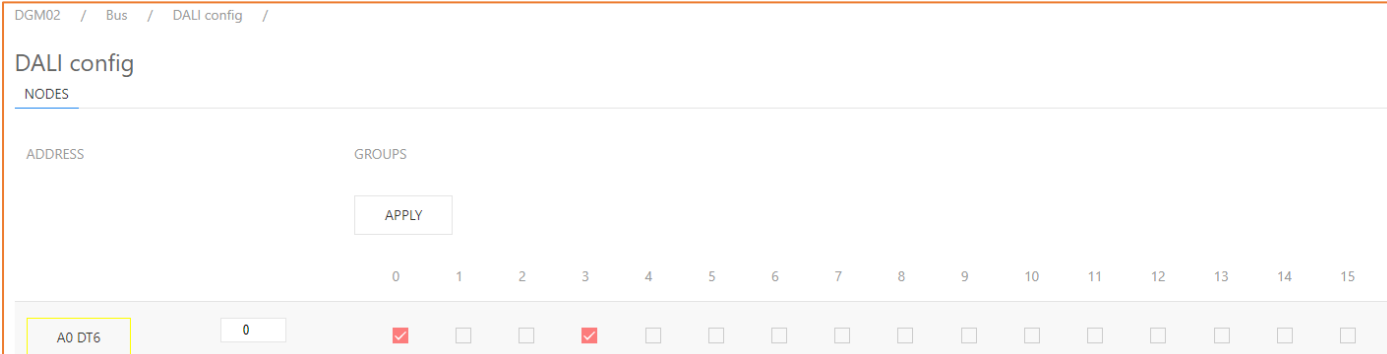

The screenshot shows the 'DALI config' interface with the 'NODES' tab selected. The 'ADDRESS' field is set to 'A0 DT6'. The 'GROUPS' field is set to '0'. A white 'APPLY' button is visible above the 'GROUPS' field. Below the 'GROUPS' field, there are 16 checkboxes labeled 0 through 15. Checkboxes for groups 0 and 3 are checked with a red checkmark.

As confirmation of the assignment of the address to the group, the box changes from red to blue



The screenshot shows the 'DALI config' interface with the 'NODES' tab selected. The 'ADDRESS' field is set to 'A0 DT6'. The 'GROUPS' field is set to '0'. A blue checkmark is visible in the 'GROUPS' field. Below the 'GROUPS' field, there are 16 checkboxes labeled 0 through 15. Checkboxes for groups 0 and 3 are checked with a blue checkmark.

REMOVING A GROUP

By clicking on one of the 16 boxes depicting the available groups (ie from 0 to 15) it is possible to remove the desired address from a DALI Group. Subsequently, by pressing the "APPLY" button that appears at the top, the command is sent on the DALI BUS.

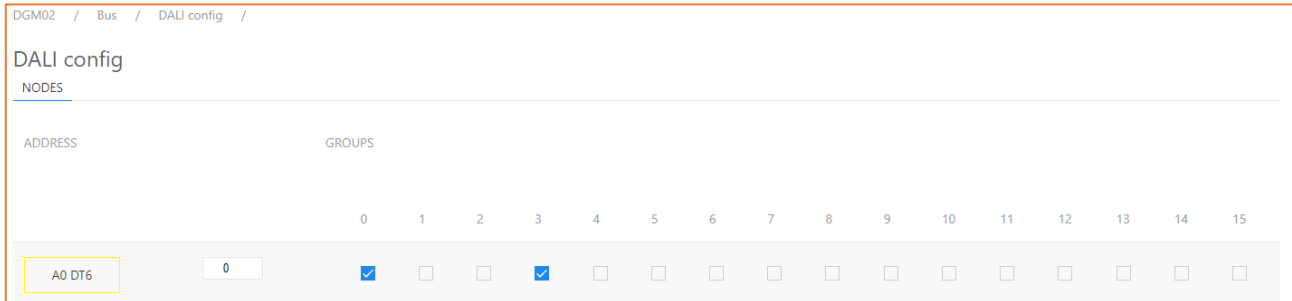

DGM02 / Bus / DALI config /

DALI config

NODES

ADDRESS GROUPS

ADDRESS	GROUPS	0	1	2	3	4	5	6	7	8	9	10	11	12	13	14	15
A0 DT6	0	<input checked="" type="checkbox"/>	<input type="checkbox"/>	<input type="checkbox"/>	<input checked="" type="checkbox"/>	<input type="checkbox"/>	<input type="checkbox"/>	<input type="checkbox"/>	<input type="checkbox"/>	<input type="checkbox"/>	<input type="checkbox"/>	<input type="checkbox"/>	<input type="checkbox"/>	<input type="checkbox"/>	<input type="checkbox"/>	<input type="checkbox"/>	<input type="checkbox"/>

Removal from the G3 group of the A0 address

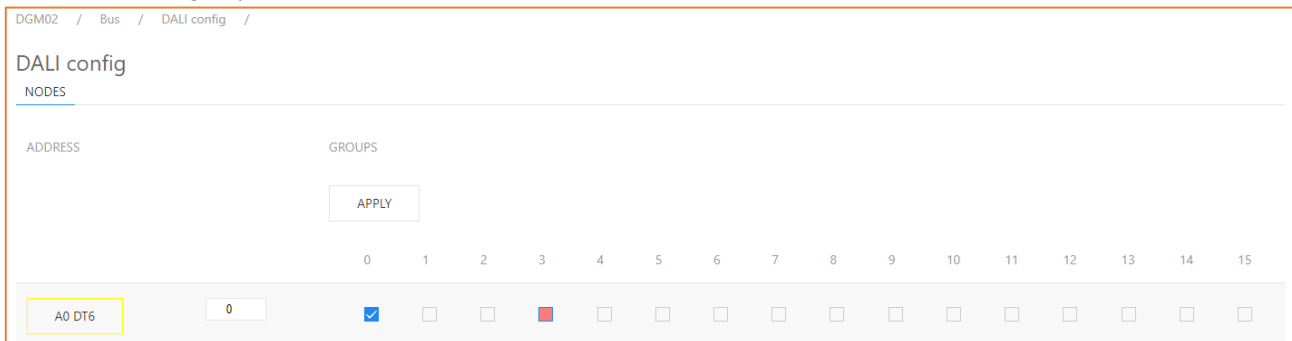

DGM02 / Bus / DALI config /

DALI config

NODES

ADDRESS GROUPS

ADDRESS	GROUPS	0	1	2	3	4	5	6	7	8	9	10	11	12	13	14	15
A0 DT6	0	<input checked="" type="checkbox"/>	<input type="checkbox"/>	<input type="checkbox"/>	<input type="checkbox"/>	<input type="checkbox"/>	<input type="checkbox"/>	<input type="checkbox"/>	<input type="checkbox"/>	<input type="checkbox"/>	<input type="checkbox"/>	<input type="checkbox"/>	<input type="checkbox"/>	<input type="checkbox"/>	<input type="checkbox"/>	<input type="checkbox"/>	<input type="checkbox"/>

Removal took place

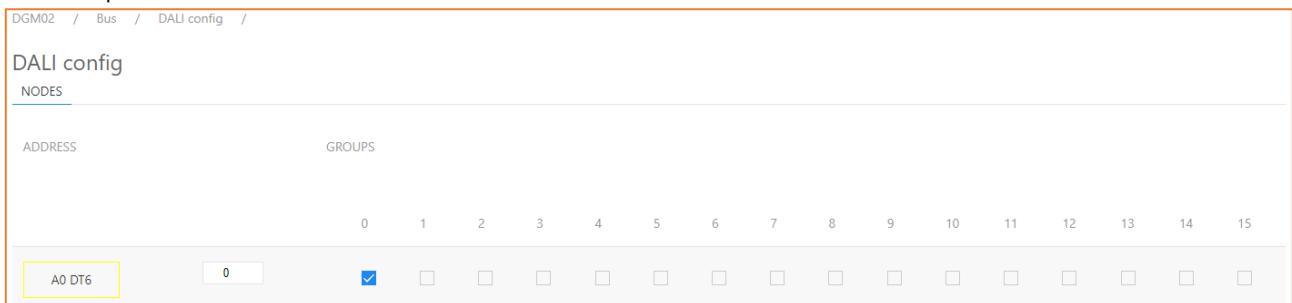

DGM02 / Bus / DALI config /

DALI config

NODES

ADDRESS GROUPS

ADDRESS	GROUPS	0	1	2	3	4	5	6	7	8	9	10	11	12	13	14	15
A0 DT6	0	<input checked="" type="checkbox"/>	<input type="checkbox"/>	<input type="checkbox"/>	<input type="checkbox"/>	<input type="checkbox"/>	<input type="checkbox"/>	<input type="checkbox"/>	<input type="checkbox"/>	<input type="checkbox"/>	<input type="checkbox"/>	<input type="checkbox"/>	<input type="checkbox"/>	<input type="checkbox"/>	<input type="checkbox"/>	<input type="checkbox"/>	<input type="checkbox"/>

STATE OF THE DALI NODE

The status of the DALI node is displayed in the outline of the button depicting the address number, and is as follows:

- ◆ Black: node present and off
- ◆ Yellow: node present and switched on
- ◆ Red: node present but not responding correctly (LAMP FAILURE)

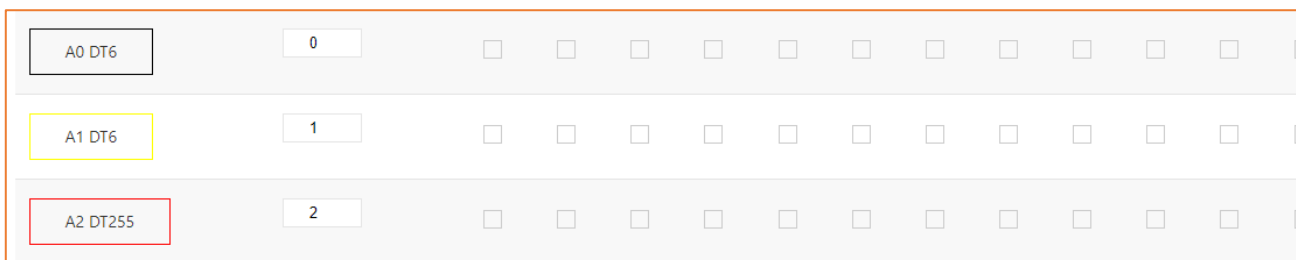

A0 DT6	0	<input type="checkbox"/>	<input type="checkbox"/>	<input type="checkbox"/>	<input type="checkbox"/>	<input type="checkbox"/>	<input type="checkbox"/>	<input type="checkbox"/>	<input type="checkbox"/>	<input type="checkbox"/>	<input type="checkbox"/>	<input type="checkbox"/>	<input type="checkbox"/>	<input type="checkbox"/>	<input type="checkbox"/>	<input type="checkbox"/>	<input type="checkbox"/>
A1 DT6	1	<input type="checkbox"/>	<input type="checkbox"/>	<input type="checkbox"/>	<input type="checkbox"/>	<input type="checkbox"/>	<input type="checkbox"/>	<input type="checkbox"/>	<input type="checkbox"/>	<input type="checkbox"/>	<input type="checkbox"/>	<input type="checkbox"/>	<input type="checkbox"/>	<input type="checkbox"/>	<input type="checkbox"/>	<input type="checkbox"/>	<input type="checkbox"/>
A2 DT255	2	<input type="checkbox"/>	<input type="checkbox"/>	<input type="checkbox"/>	<input type="checkbox"/>	<input type="checkbox"/>	<input type="checkbox"/>	<input type="checkbox"/>	<input type="checkbox"/>	<input type="checkbox"/>	<input type="checkbox"/>	<input type="checkbox"/>	<input type="checkbox"/>	<input type="checkbox"/>	<input type="checkbox"/>	<input type="checkbox"/>	<input type="checkbox"/>

DALI CONTROLLER – BUS 3

In DALI Controller mode the device transmits the DALI channels according to an algorithm that updates only the nodes that change intensity value.

In this way, only the intensity change command is sent to the concerned DALI node.

By selecting the NODES item, it is possible to see the nodes addressed;

DALI controller		
NODES	GROUPS	
ADDRESS	GROUPS	
A0 DT6	G0	G1
A1 DT6	G2	G3
A2 DT6	G4	G5
A3 DT6	G6	G7

Instead by selecting the GROUPS item, it is possible to see the groups to which the nodes belong.

DALI controller	
NODES	GROUPS
GROUP	ADDRESSES
G0	A0 DT6
G1	A0 DT6
G2	A1 DT6
G3	A1 DT6
G4	A2 DT6
G5	A2 DT6
G6	A3 DT6
G7	A3 DT6

DMX512 GLOBAL SETTINGS & RS485 – DMX MASTER (BUS 1 & BUS 2)

Setting BUS 1 (or BUS 2) as DMX512 Master in the pop-up menu activates the **DMX512 GLOBAL SETTINGS** and **RS485** sections.

The fields displayed in the RS485 section for Bus 1 (or Bus 2) are:

- ◆ "Baud rate": only 250000;
- ◆ "Stop bit" 2 bits;
- ◆ "Parity" none;

A universe of 512 channels can be received on both buses BUS1 and BUS2.

Bus 2

Baud rate

Stop Bit

Parity

The fields displayed in the **DMX512 GLOBAL SETTINGS** section for Bus 1 (or Bus 2) are:

- ◆ "Minimum Scan Time";
- ◆ "Maximum Scan Time";
- ◆ "Minimum RX Break Pulse Duration [us]";
- ◆ "Maximum RX Break Pulse Duration [us]";

Bus 2

Minimum scan time:

Maximum scan time:

Minimum Rx Break Pulse Duration [us]

Maximum Rx Break Pulse Duration [us]

DMX512 GLOBAL SETTINGS & RS485 – DMX SLAVE (BUS 1 & BUS 2)

Setting BUS 1 (or BUS 2) as DMX512 Slave in the pop-up menu activates the **DMX512 GLOBAL SETTINGS** and **RS485** sections.

The fields displayed in the **RS485** section for Bus 1 (or Bus 2) are:

- ◆ "Baud rate", only 250000;
- ◆ "Stop bit" 2 bit;
- ◆ "Parity" no-one.

A universe of 512 channels can be received on both buses BUS1 and BUS2.

Bus 2

Baud rate

Stop Bit

Parity

The fields displayed in the **DMX512 GLOBAL SETTINGS** section for Bus 1 (or Bus 2) are:

Bus 2

Minimum scan time:

Maximum scan time:

Minimum Rx Break Pulse Duration [us]

Maximum Rx Break Pulse Duration [us]

- ◆ "Minimum Scan Time";
- ◆ "Maximum Scan Time";
- ◆ "Minimum RX Break Pulse Duration [us]";
- ◆ "Maximum RX Break Pulse Duration [us]";

MODBUS MASTER & RS485 – MODBUS RTU MASTER (BUS 1 & BUS 2)

Setting BUS 1 (or BUS 2) as MODBUS RTU Master in the pop-up menu activates the **RS485** sections and the **MODBUS RTU Master**.

The fields displayed in the **RS485** section for Bus 1 (or Bus 2) are:

- ◆ "Baud rate";
- ◆ "Stop bit";
- ◆ "Parity".

Bus 1

Baud rate

Stop Bit

Parity

The fields displayed in the **MODBUS RTU Master** section for Bus 1 (or Bus 2) are:

- ◆ "Minimum Scan Time";
- ◆ "Maximum Scan Time";
- ◆ "RX timeout";
- ◆ "TxA80idOf6".

Bus 1

Minimum scan time:

Maximum scan time:

RX timeout

TxA80idOf6

The information is transmitted to 80 slaves (ID 1...80).

A group of 6 channels is sent to each slave:

- ◆ ID1: channels 1 to 6 are sent in registers 0 to 5
- ◆ ID2: channels 7 to 12 are sent in registers 0 to 5
- ◆ ...
- ◆ ID80: channels from 475 to 480 are sent in registers 0 to 5

MODBUS SLAVE & RS458 – MODBUS RTU SLAVE (BUS 1 & BUS 2)

Setting BUS 1 (or BUS 2) as MODBUS RTU Slave in the pop-up menu activates the **RS485** sections and the **MODBUS RTU Slave**.

The fields displayed in the RS485 section for Bus 1 (or Bus 2) are:

- ◆ "Baud rate";
- ◆ "Stop bit";
- ◆ "Parity".

Bus 1

Baud rate

Stop Bit

Parity

The fields displayed in the **MODBUS RTU Slave** section for Bus 1 (or Bus 2) are:

- ◆ "Slave ID";

The ID is selectable via the web server interface.

The information is received on the Modbus RTU Slave page.

It is possible to read and write 512 registers with a value from 0 to 255.

Bus 1

Slave ID

SECTION: DIAGNOSTIC – LOG

In the LOG section it is possible to carry out a diagnostic of the product.

Diagnostic

SEVERITY LEVEL

VERBOSE LEVEL

MODULE

CODE

SOURCE

DATA

SECTION: DIAGNOSTIC – LOG CONFIGURATION

In the case of remote assistance, it is possible to check the errors that will be recorded in the "LOG" section.

In this case it is useful to configure the type of diagnostics by accessing the "Log Configuration" section, the following page will be displayed:

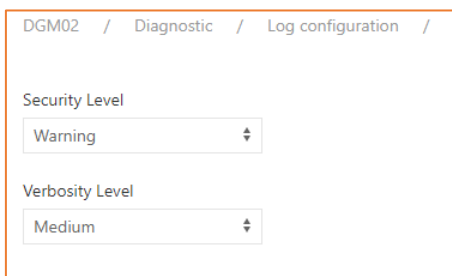

DGM02 / Diagnostic / Log configuration /

Security Level
Warning

Verbosity Level
Medium

The "SECURITY LEVEL" sets what type of information you want to view on the Log:

- ◆ "Info" information about the system that does not denote any type of problem;
- ◆ "Warning" information that denote the correct functioning of the system but which may affect its functioning;
- ◆ "Fault" that cause an actual impact on the system.

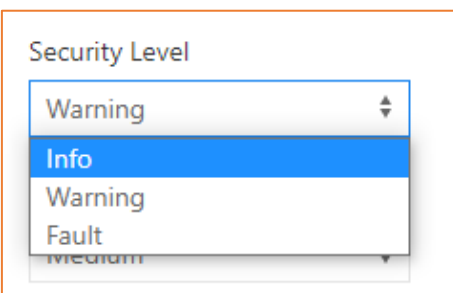

Security Level

Warning

Info

Warning

Fault

Medium

The "VERBOSE LEVEL" denotes the level of information we have above and are: "Low" low level, "Medium" medium level and "High" high level.

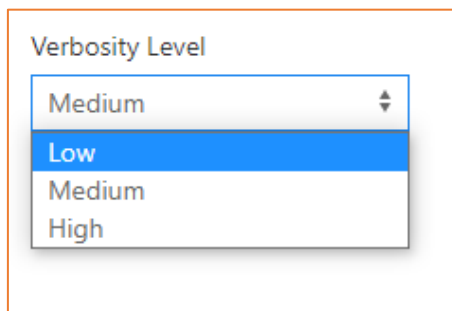

Verbosity Level

Medium

Low

Medium

High

NETWORK

DGM02 / Settings / Network /

IP Address

Netmask

Gateway

MAC Address

The DGM02 device uses the ethernet port using the IPv4 protocol.

The default IP address is: **192.168.1.4**.

In the "Network" section, you can change the IP Address, the Netmask.
The MAC Address is unique to the product and cannot be changed.

After modifying the settings, click on the "**APPLY**" button at the top right, otherwise the changes will be lost.
With the "**CLEAR**" button the changes are cancelled.

NOTE: pay attention to the fact that the "subnet" must coincide for all the devices that must communicate, for example with the "net-mask" 255.255.255.0 all the devices must have the address 192.168.1.xxx To be visible.

LOGIN INFO

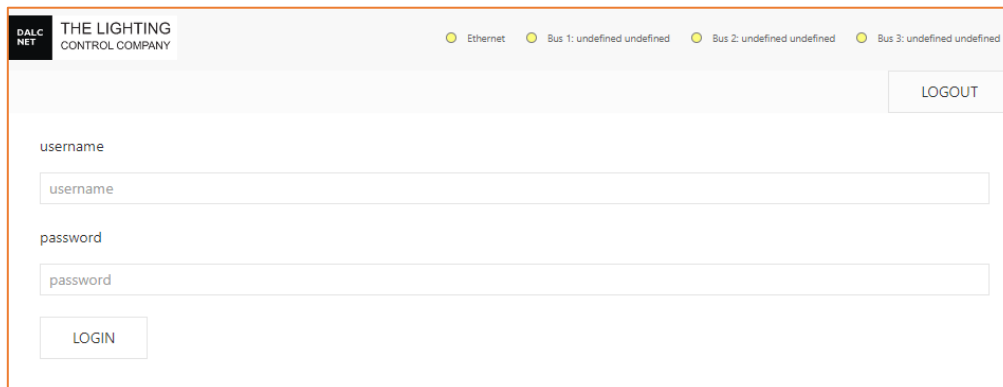

EDIT CREDENTIALS, PROCEDURE:

- ◆ After opening the browser (we recommend using Google Chrome), access the local Gateway address.
- ◆ Enter username and password in the corresponding fields.
There are two access modes: ADMIN and USER.
- ◆ In **ADMIN** mode, you have full access to the system settings and the default credentials are:
Username = admin
Password = admin
- ◆ In USER mode it is possible to view only the Channels section and the default credentials are:
Username = user
Password = user
- ◆ Finally, press the LOGIN key to log in.
- ◆ In **ADMIN** mode it is possible to change the username and password of the two users by clicking on Login Settings in the menu and entering the desired credentials.

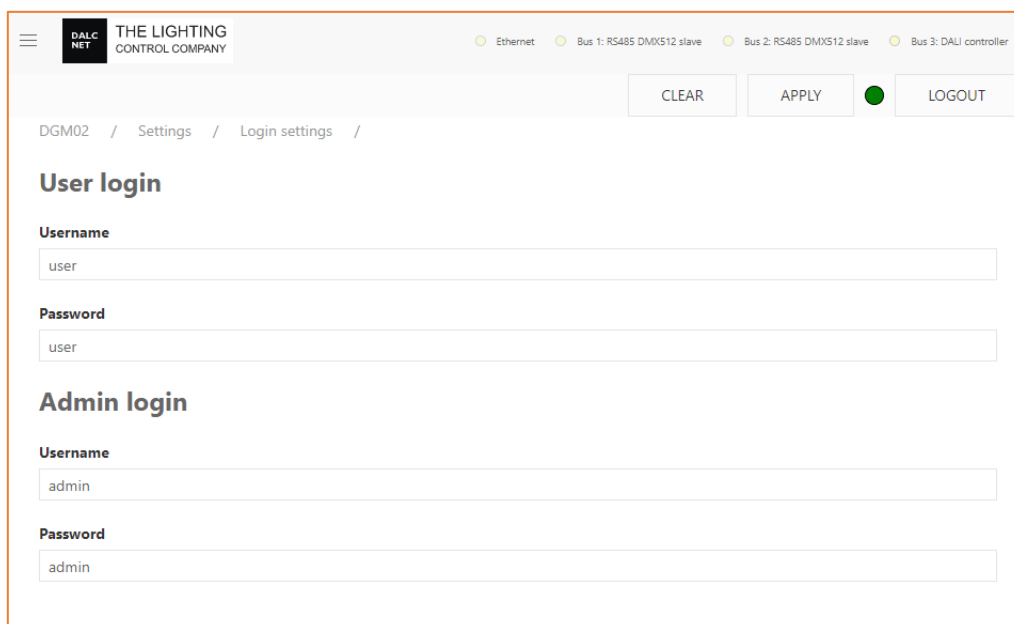

After modifying the settings, click on the "APPLY" button at the top right, otherwise the changes will be lost.
With the "CLEAR" button the changes are cancelled.

FIRMWARE UPDATES

DGM02 / Settings / Firmware update /

DGM02 Firmware update

Firmware version: 1.0.0

Nessun file selezionato

On this page you can update the firmware to the latest version available.

FIRMWARE UPLOAD, PROCEDURE:

1. From the web page menu, access the "Firmware Update" section;
2. Click on "Choose File" and select the version of the FW to load;
The file to be uploaded has an .upf format;
3. Once selected, click on "Update Now" and wait for the file to be loaded correctly within the DGM02;
4. Once the upload is complete, click on the "Reboot" button;
5. After having pressed the "Reboot" button, the DGM02 will reboot.
6. At the next switching on, the 2 leftmost LEDs will flash simultaneously to indicate that the Reboot has been carried out correctly;
7. At this point the DGM02 will update to the new FW version. The progress of the update can be seen as the LEDs will light up sequentially from right to left.
8. Once the update has been carried out, the DGM02 will return to the home page;
9. If, on the other hand, after point 6, the LEDs return to flash in standard mode, it means that the firmware update has not been performed;

NOTE: DO NOT DISCONNECT THE POWER SUPPLY OF DGM02 UNTIL THE UPDATE IS FINISHED.

SACN (ETHERNET)

DGM02 implements the sACN protocol and can be used as a sACN → DMX and sACN → DALI gateway from the main software and lighting control systems.

The port used is UDP 5568.

DGM02 / Settings / sACN /

Enabled

UDP Port

After modifying the settings, click on the "APPLY" button at the top right, otherwise the changes will be lost. With the "CLEAR" button the changes are cancelled.

TCP TELNET (ETHERNET)

The DGM02 has a Telnet server capable of receiving and / or transmitting a DMX512A / DALI / MODBUS RTU universe from / to other devices via TCP protocol. Communication occurs by establishing a connection on TCP port 23 (Telnet).

The minimum settable interval for sending response strings is defined as "min scan time".

In the event that no changes are detected, the interval with which the string is periodically sent is defined with the value set to "max scan time". The zero value disables periodic transmission.

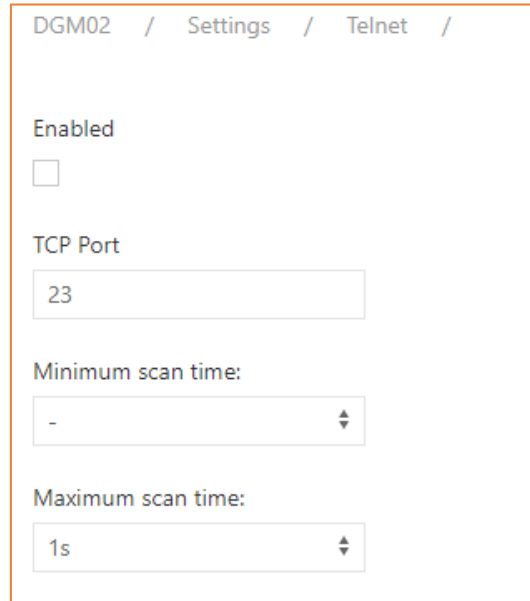

After modifying the settings, click on the "APPLY" button at the top right, otherwise the changes will be lost. With the "CLEAR" button the changes are cancelled.

The status of 512 light intensity levels or even fewer levels can be sent in a single ASCII string.

DATA LEVEL

The request is enclosed by the <data> and </data> tags:

```
<data addr = '0000' size = '0200'> .... </data>
```

- The addr field indicates, in hexadecimal notation, the first slot to be transmitted.
- The size field indicates, in hexadecimal notation, the slot number to be transmitted.

Inside the tags, the slots to be transmitted with a range from 00 to FF must be inserted in hexadecimal notation.

The number of character pairs between the <data> and </data> tags must equal the number of slots to be transmitted

Settings example:	Send:
the first lamp at maximum and the rest off	<data addr='0000' size='0200'>FF000000...00</data>
the second lamp at maximum and the rest off	<data addr='0000' size='0200'>00FF0000...00</data>
the second lamp at 50% brightness and the rest off	<data addr='0000' size='0200'>00800000...00</data>
the first lamp at most without changing the others	<data addr='0000' size='0001'>FF<data>
the second lamp at most without changing the others	<data addr='0001' size='0001'>FF</data>
the second and third at 50% without changing the others	<data addr='0001' size='0002'>8080</data>
To request status without changing any values	<data addr='0000' size='0000'><data>

POWER-ON: DEFAULT LEVELS

With the string delimited by the <wdef> and </wdef> tags it is possible to save in volatile memory the default values to be transmitted to the power-up.

Storage of current values as Power-On values:	<wdef></wdef>
---	---------------

QUERY DALI DEVICE TYPE

This command lets you know the node types present in the 512 available nodes.
The command to send must be enclosed in these tags: <type> and </type>.

Request sent	<type addr='0000' size='0003'></type>
Risposta da DGM Device type (ti): 00: node type not defined 0x01: DALI node, only brightness level 0x04: DALI node type DT4 0x06: DALI node type DT6 0x08: DALI node type DT8 0x80: DMX configured as master 0x81: DMX configured as slave 0x90: MODBUS configured as master 0x91: MODBUS configured as slave 0xBF Multiple bus definition: 0xFF: DALI node, not defined	<type>010800</type> t1 t2 t3

SET RGBWAF DALI DT8 COLOUR LEVELS

This command is used to set colour levels. If the addressed device is of the DT8 type, the DGM will set the correct color levels, based on the new value, otherwise the command will have no effect. The command is enclosed by the tags: <scol> and </scol>. The maximum size is fixed at 64.

The MASK value 0xFF is used to leave the current colour unchanged.

Address: The address refers to the current position on the internal database, where the Dali node is located.

Size: maximum size = 64.

Set color levels (DT8 devices only)	<scol addr='0000' size='0002'>808010000000FF0080000000</scol> R G B W A F R G B W A F
-------------------------------------	--

R = red G = green B = blue W = white A = amber F = free color

NOTE: When all color levels are set to 0, the DALI ballast goes into "OFF state".

This means that to set a new color configuration it is necessary to first send a brightness level higher than zero to the node in order to restore the "ON state".

QUERY RGBWAF DALI DT8 COLOUR LEVELS

This command is used to query colour levels.

If the addressed device is of type DT8, the DGM responds with the current color levels / 6 bytes per device), otherwise it returns all data at 00. The request is enclosed by the tags: `<rcol>` and `</rcol>`.

The maximum size is fixed at 64.

If a node is not of type DT8, the colour codes are all set to zero (6 times 0x00).

Request color levels	<code><rcol addr='0000' size='0002'></rcol></code>
Answer from DGM	<code><rcol>808010000000FE0080000000</rcol> R G B W A F R G B W A F </code>

R = red

G = green

B = blue

W = white

A = amber

F = free color

SET COLOR TC LEVEL

This command is used to set the correlated color temperature (Tc). If the addressed device is a TW (Tunable White) type DT8, the DGM will set the correct Tc, based on the new value, otherwise the command has no effect. The command is enclosed by the tags: `<sctc>` and `</sctc>`.

The maximum size is fixed at 64.

The MASK value 0xFF is used to leave the current color unchanged.

Address: the address refers to the current position on the DB, where the Dali node is located.

Size: maximum size = 64

Set color levels (DT8 TW devices only)	<code><sctc addr='0000' size='0001'>FD01</sctc></code>
--	--

To calculate the command value to use based on the CCT value in Kelvin, you need to use the following procedure:
Convert the Kelvin CCT value to Mirek:

$$\text{Mirek value} = \frac{1000000}{\text{Kelvin value}} \quad \text{example } 3000\text{K} \rightarrow \frac{1000000}{3000} = 333 \text{ Mirek}$$

The Mirek value must be converted into hexadecimal: for example, 333 -> 014D

The third and fourth digits of the value became the first and second digits of the command

The first and second digits of the value have become the third and fourth digits of the command

Example

01 4D

4D 01

To set the CCT to 3000K on address A0 you need to use the following command:

`<sctc addr = '0000' size = '0001'> 4D01 </sctc>`

See the table below for reference:

CCT (K)	Command	CCT (K)	Command	CCT (K)	Command	CCT (K)	Command	CCT (K)	Command
2200	C701	3000	4D01	3900	0001	4800	D000	5700	AF00
2300	B301	3100	4301	4000	FA00	4900	CC00	5800	AC00
2400	A101	3200	3901	4100	F400	5000	C800	5900	A900
2500	9001	3300	2F01	4200	EE00	5100	C400	6000	A700
2600	8101	3400	2601	4300	E900	5200	C000	6100	A400
2700	7201	3500	1E01	4400	E300	5300	BD00	6200	A100
2800	6501	3600	1601	4500	DE00	5400	B900	6300	9F00
2900	5901	3700	0E01	4600	D900	5500	B600	6400	9C00
2950	5301	3800	0701	4700	D500	5600	B300	6500	9A00

QUERY COLOR TC LEVELS

This command is used to submit a query for Tc levels. If the addressed device is of type DT8 TW, the DGM responds with the current colour levels (2 bytes per device), otherwise it returns all data to 00. The request is enclosed by the tags: <rctc> and </rctc>.

The maximum size is fixed at 64.

If a node is not of type DT8, the Tc codes are all set to zero (2 times 0x00).

Query tc colour levels	<rctc addr='0000' size='0001'></rctc>
DGM answer	<rctc>FD01</rctc>

FADE ENGINE

One or more fadings can be initiated at 512 brightness levels (fades). This request is performed with a string enclosed by the <fade> and </fade> tags:

```
<fade time = '0000' addr = '0000' size = '0200'> .... </fade>
```

- ◆ The field time indicates, in hexadecimal notation, the fade time in 0.1s units, with an interval from 0.1 to 3600 seconds (1 hour).
The minimum slope is 25.5 seconds per step; This means that the maximum fade time to go from 0 to 1 level (or from 35 to 34 for example) is 25.5s, to go from 0 to 2 level is 51s. The slope is limited internally. The value "0000" indicates to stop fading at the actual value.
- ◆ The addr field indicates, in hexadecimal notation, the first slot to be transmitted.
- ◆ The size of the field indicates, in hexadecimal notation, the number of slots to be transmitted.

The slots to be transmitted must be inserted inside the tags, in the range from 00 to FF in hexadecimal notation. The value set to "XX" indicates that the fade is not processed for the corresponding channel.

A maximum of 64 values (i.e. channels) can be sent in a single packet, so at least 8 packets must be sent to initiate a fade on all 512 channels.

For example, to set:	Send:
the first lamp at maximum level and the third off, with 5 seconds of fade time	<fade time='0032' addr='0000' size='0003'>FFXX00</fade>

When packets are received by Ethernet or field bus and with fade control active, each time a string is received a string is sent as a response with a minimum configurable time (minimum scan time):

```
<date> 010203040506070809 ..... </date>
```

Reports the status of all 512 light intensity levels. If there are no changes, the string is still sent with a configurable time (maximum scan time) if greater than zero.

NOTE: The spacing and order of the fields must be strictly adhered to. The transmission string must be sent strictly in a single TCP packet; The response string is sent in a single TC packet

ART-NET 4 (ETHERNET)

DGM02 implements the Art-Net 4 protocol and can be used as an Art-Net → DMX and Art-Net → DALI gateway from the main software and lighting control systems. The port used is UDP 6454.

DGM02 / Settings / ARTNet /

Enabled

UDP Port

IMPLEMENTED PACKET

OpCode	Note
ArtDmx	Sub-Net and Universe are routed to the DGM universe
ArtPoll	

After modifying the settings, click on the "APPLY" button at the top right, otherwise the changes will be lost. With the "CLEAR" button the changes are canceled.

MODBUS TCP (ETHERNET)

The DGM02 has a MODBUS TCP / IP server capable of receiving and / or transmitting a DMX512A universe to one or more Modbus devices on the Ethernet network. 512 registers are available, with Modbus address from 0 to 511 and value from 0 to 255. The port used is TCP 502, the Slave ID is not considered.

DGM02 / Settings / MODBUS TCP Slave /

Enabled

UDP Port

Slave ID

After modifying the settings, click on the "APPLY" button at the top right, otherwise the changes will be lost. With the "CLEAR" button the changes are canceled.

IMPLEMENTED PACKET

Function Code	Function Name
03	Read Holding register
06	Write Single Register
16	Write Multiply Register