

CORNER14 EF/TY

ANGULAR PROFILE 30°/60°

- hidden mounting
- two lighting angles: 30°/60°
- maximum LED strip width: 14 mm



SIMILAR IN THE OFFER / PODOBNE W OFERCIE



- E** slide cover
- F** click cover
- E7** E7 click cover
- Y¹** Y flexible mounting plate
- Y²** cone Y flexible mounting plate
- T** T mounting plate

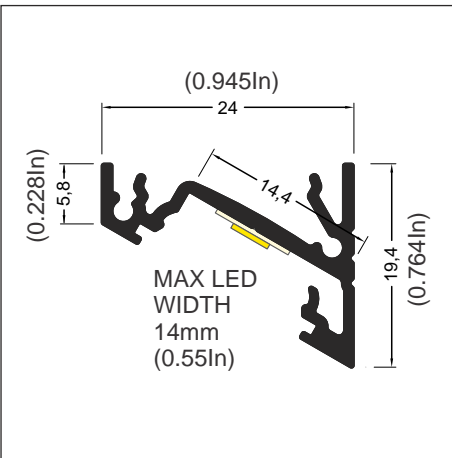
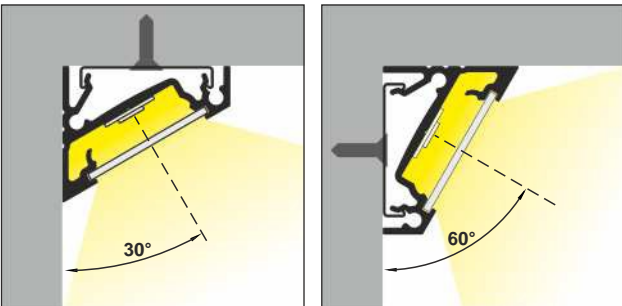
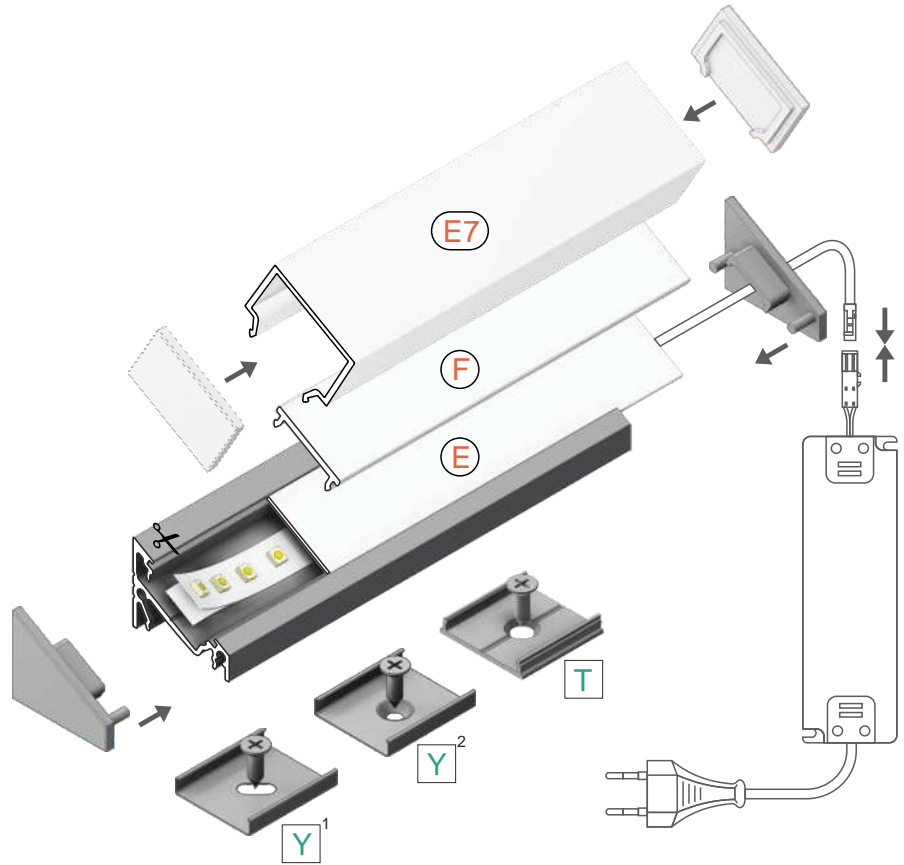

Length 2000 mm

white painted

LED-A4020001

anodized

LED-A4020020

black anodized

LED-A4020021

raw aluminium

LED-A4020000



max 14 mm



corner

Available lengths: 1000 mm, 2000 mm, 3000 mm, 4000 mm.
 The standard profile length tolerance is +20 mm.

* Parameters tolerance +/- 7%

ACCESSORIES

COVERS

E slide cover
 colours: transparent, frosted, opal
 material: PC, PP, PP



Note! Dimensions of the space to install LED source

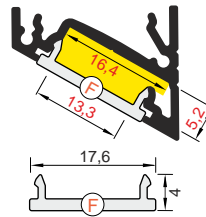
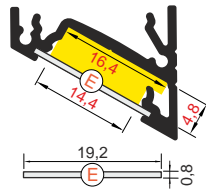

F click cover
 colours: transparent, opal
 material: PMMA

E7 click cover
 colour: opal
 material: PMMA

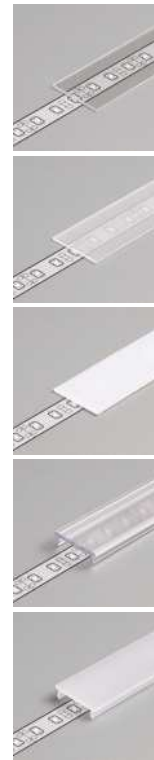
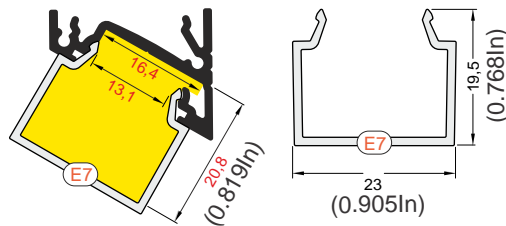

Sold in lengths of 2m (6.56ft)

E transparent
LED-A2040016

E frosted
LED-A2040039

E opal
LED-A2040038

F Transparent
LED-A2060016

F opal
LED-A2060038

NEW



reel, length 20 m

F opal
LED-A2210038S



length 2000 mm

E7 opal
 Sold in lengths of 2m (6.56ft)
LED-C1080038

The standard cover length tolerance is +20 mm.

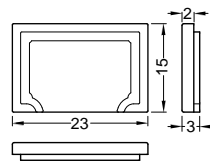

Sold in pairs of two endcaps

E7 opal ending

LED-C1840038

MOUNTING

Y flexible mounting plate
 colour: inox
 material: stainless steel

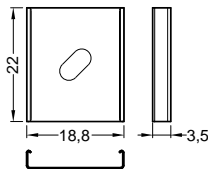
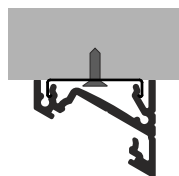

Sold in pairs of two

inox
A2090019

cone Y flexible mounting plate
 colour: inox
 material: stainless steel

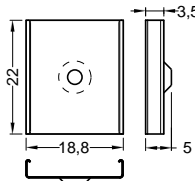
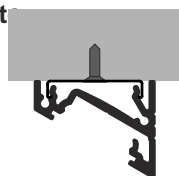

inox
A2130019

* Parameters tolerance +/- 7%

ACCESSORIES

MOUNTING

T mounting plate
 colour: raw aluminium
 material: aluminium

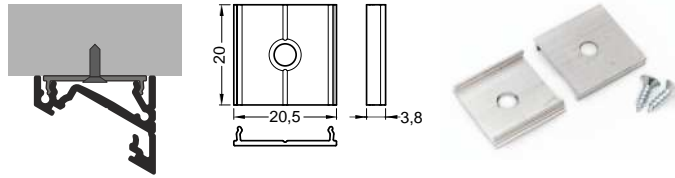

Sold in sets of two
 raw aluminium
LED-C6960000

ENDINGS

CORNER14 ending gen2
 colours: white, silver, black, grey
 material: ABS

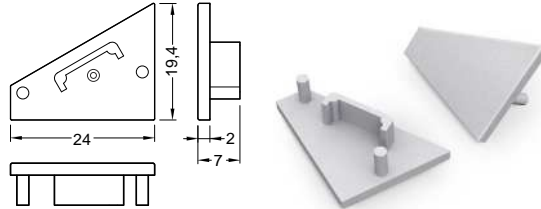

Sold in sets of two
 White
LED-A4980001
 Silver
LED-A4980040
 Black
LED-A4980002
 Gray
LED-A4980022

CORNER14 ending gen2 with hole
 colours: white, silver, black, grey
 material: ABS

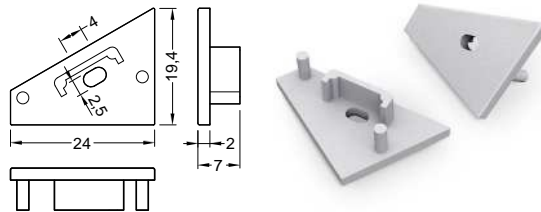

White
LED-A4970001
 Silver
LED-A4970040
 Black
LED-A4970002
 Gray
LED-A4970022

CONNECTORS

T connector 180 deg
 colour: raw aluminium
 material: aluminium

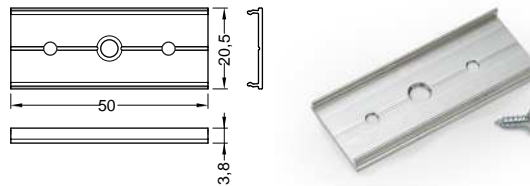

Sold as one set
 raw aluminium
LED-C6990000

CORNER14 connector 90 deg
 colours: white, anodized, black
 material: aluminium

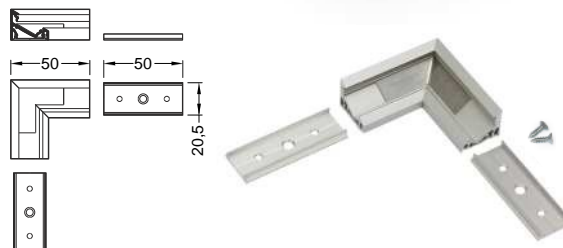

white painted
LED-A4990001
 anodized
LED-A4990020
 black anodized
LED-A4990021

