

Model Begton12

Lightweight surface mount LED Channel



- light weight, budget profile
- Slick socket
- maximum LED strip width: 12 mm



* Parameters tolerance +/- 7%

- J** J slide cover
- C** C click cover
- C*** BEGTON12 C ending for C click cover
- S¹** S flexible mounting plate
- S²** cone S flexible mounting plate

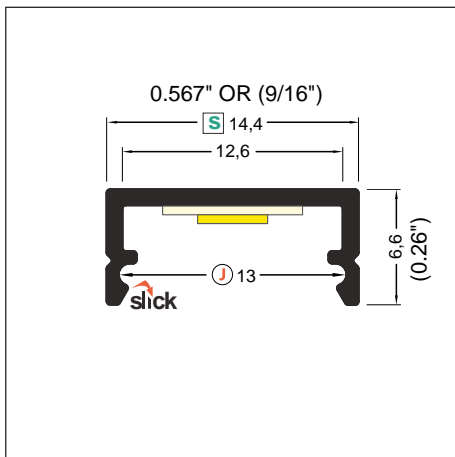
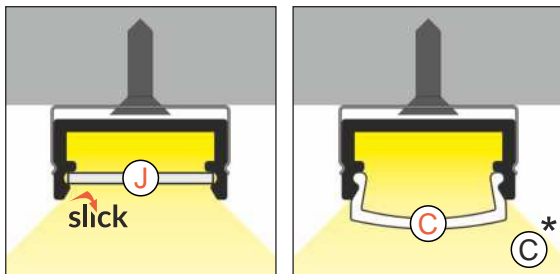
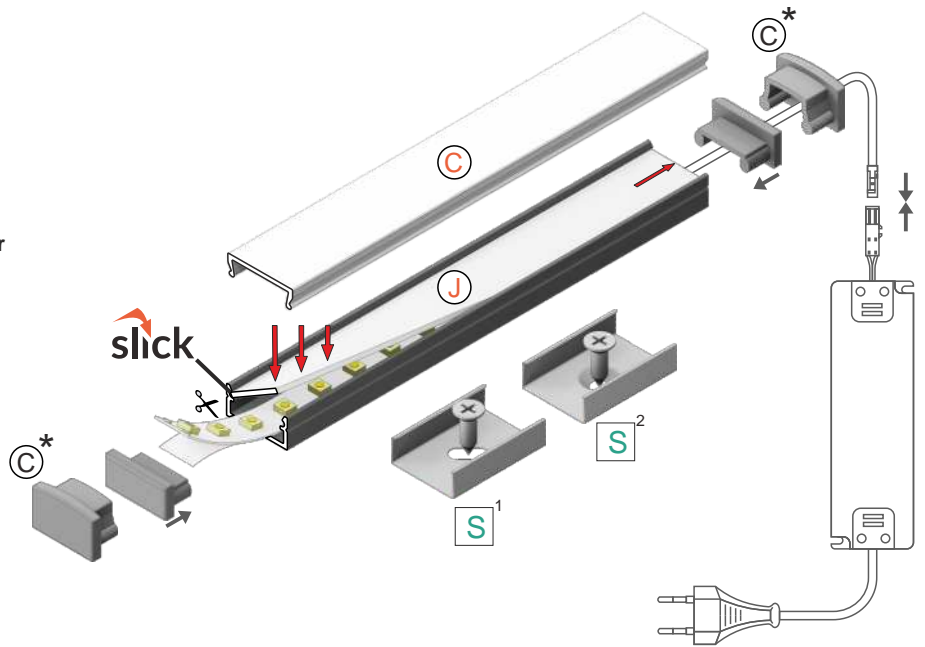

INDEX = 1 pc, length 2000 mm

white painted
LED-C7020001



anodized
LED-C7020020



black anodized
LED-C7020021



raw aluminium
LED-C7020000



max 12 mm



surface

Available lengths: 1000 mm, 2000 mm, 3000 mm, 4000 mm.
 The standard profile length tolerance is +20 mm.

* Parameters tolerance +/- 7%

ACCESSORIES

COVERS

J slide cover
 colours: transparent, frosted, opal
 material: PC, PP, PP



Note! Dimensions of the space to install LED source

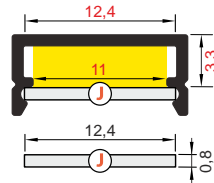

length 2000 mm

J transparent
 LED-70330016

J frosted
 LED-70330039

J opal
 LED-70330038

The standard cover length tolerance is +20 mm.

ENDINGS

BEGTON12 ending
 colours: white, silver, black, grey
 material: ABS

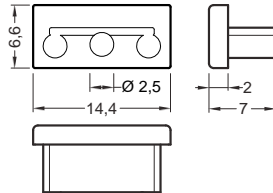

Ending with marked space to bore the holes.



Pair of endcaps = 2 pieces

White
 LED-C7960001

Silver
 LED-C7960040

Black
 LED-C7960002

Gray
 LED-C7960022

BEGTON12 C ending
 colours: white, silver, black, grey
 material: ABS

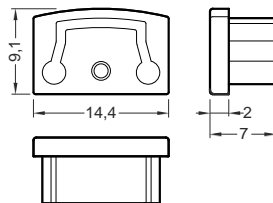

White
 LED-C7940001

Silver
 LED-C7940040

Black
 LED-C7940002

Grey
 LED-C7940022

MOUNTINGS

S flexible mounting plate
 colours: white, inox, black
 material: stainless steel

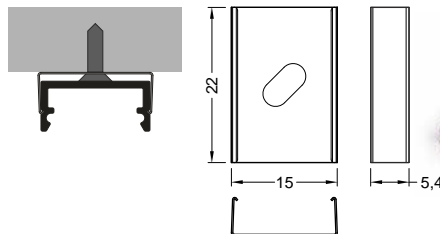

Pair of clips = 2 pieces

White
 LED-C7980001

Stainless steel
 LED-C7980019

Black
 LED-C7980002

cone **S** flexible mounting plate
 colours: white, inox, black
 material: stainless steel

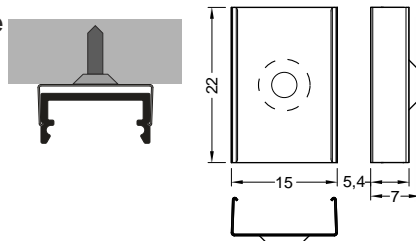

White
 LED-C7950001

Stainless steel
 LED-C7950019

Black
 LED-C7950002

* Parameters tolerance +/- 7%

Model Begton12

Lightweight surface mount LED Channel



* Parameters tolerance +/- 7%