



BEGTIN12 / JS



max 12 mm



recessed

- slick socket
- light weight, budget profile
- used mainly in furniture



* Parameters tolerance +/- 7%

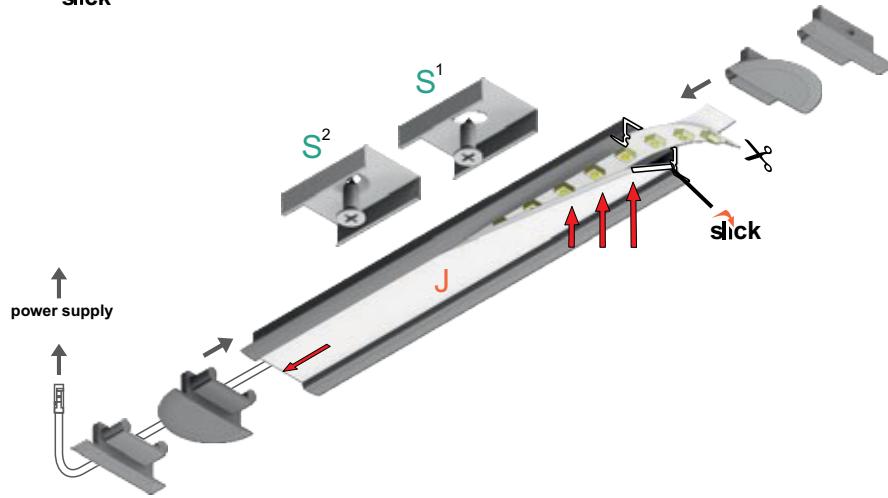
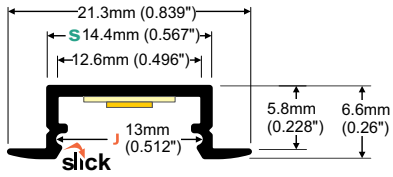

S¹
S flexible mounting
Plate

S²
cone S flexible mounting
Plate

Dimensions in millimeters

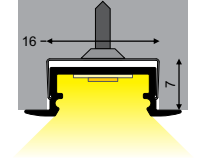
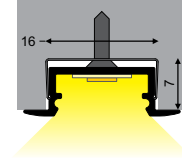

J
J slide diffuser

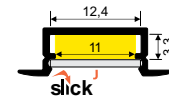

Dimensions in millimeters



White painted

LED-C8020001

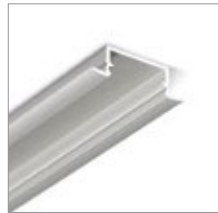

anodized

LED-C8020020P

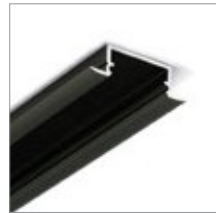

black anodized

LED-C8020021



raw aluminium

LED-C8020000P

Standard length 2000 mm

**BEGIN12 end cap
gen2 with hole**
material: ABS



White

LED-C8980001

Silver

LED-C8980040

Black

LED-C8980002

Grey

LED-C8980022

**BEGIN12 end cap
gen2 SQ with hole**
material: ABS



White

LED-C8970001

Silver

LED-C8970040

Black

LED-C8970002

Grey

LED-C8970022



* Parameters tolerance +/- 7%