

BEGTON12 J/S

SURFACE PROFILE

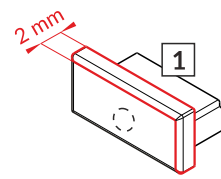
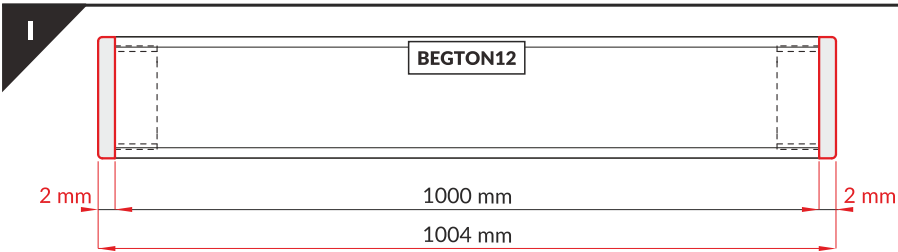
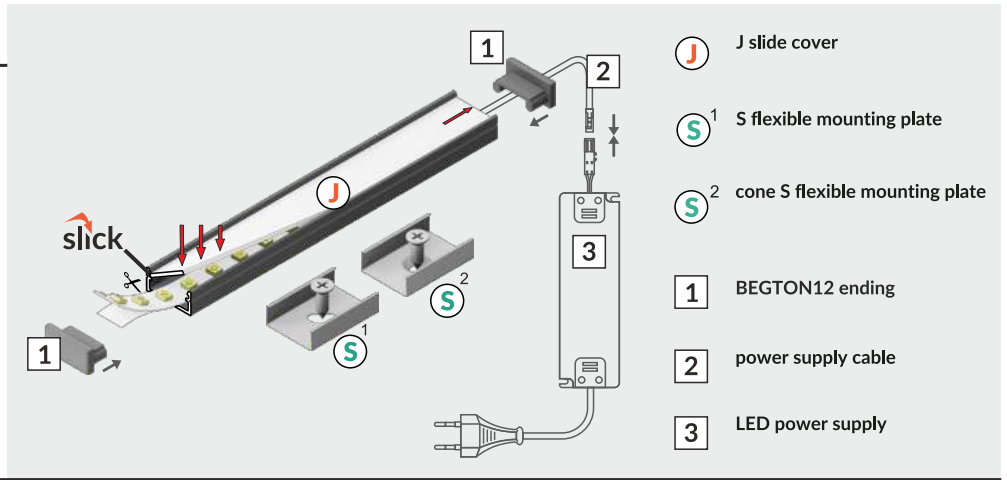
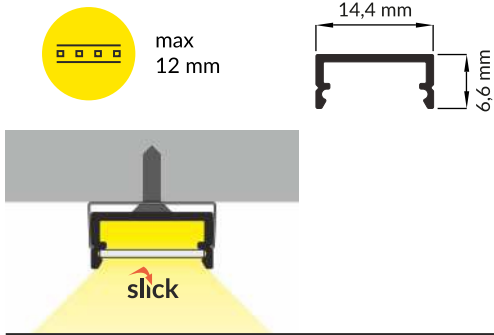

Note! Ending with marked space to bore the holes.

Note! Ending thickness increases the length of the luminaire (+ 2 x 2 mm).

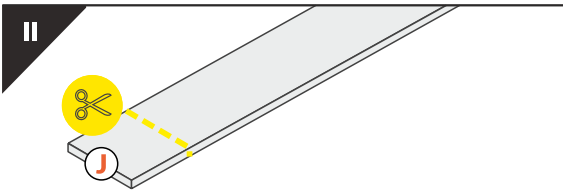

The length of the cover is equal to the length of the profile.

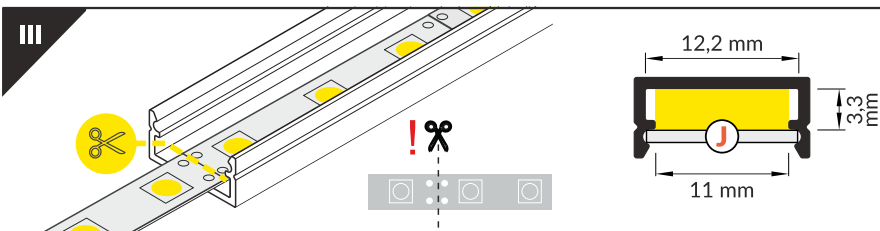

Dimensions of the space to install LED source.

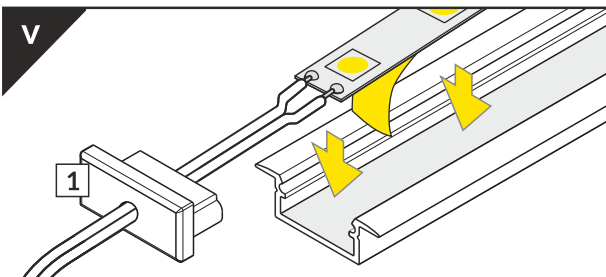
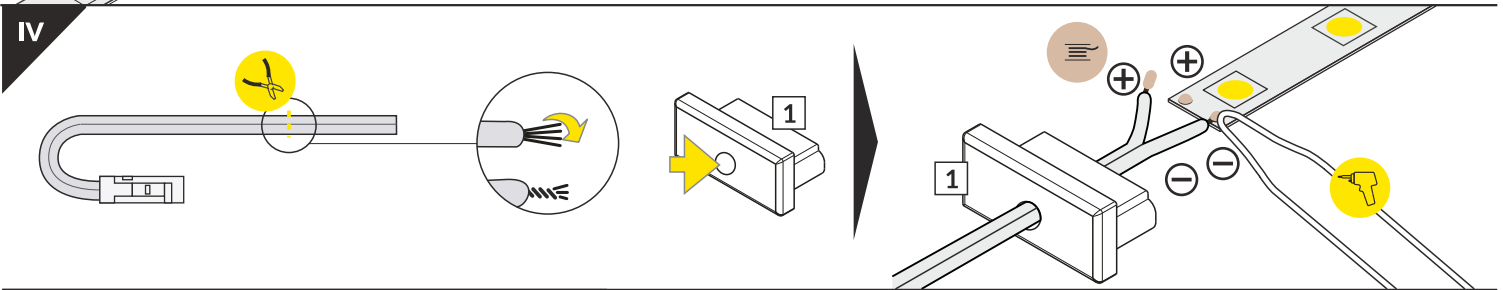

Wired 4 Signs USA
 +1 (865) 339 4956
 info@w4susa.com
 7669 Clinton Highway, Powell,
 Tennessee, 37849

BEGTON12 J/S

SURFACE PROFILE

VI

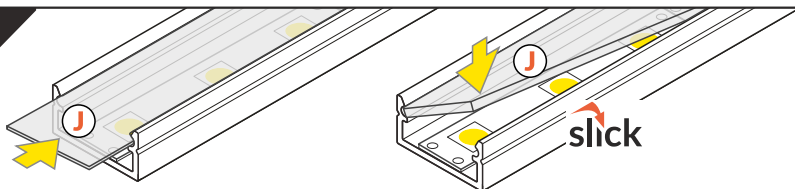

J slide cover

VII MOUNTING

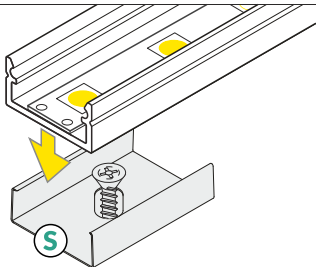

S flexible mounting plate

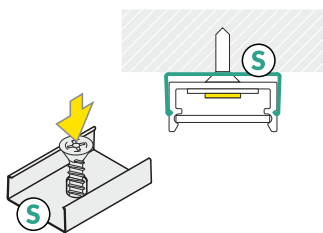

S flexible mounting plate

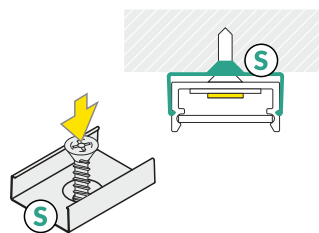

cone S flexible mounting plate

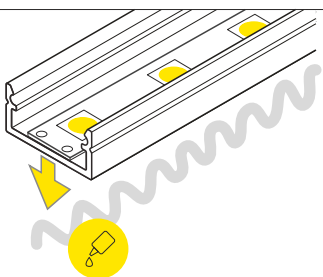

glue

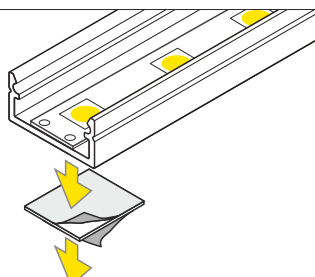

two-sided adhesive tape 25x25

VIII

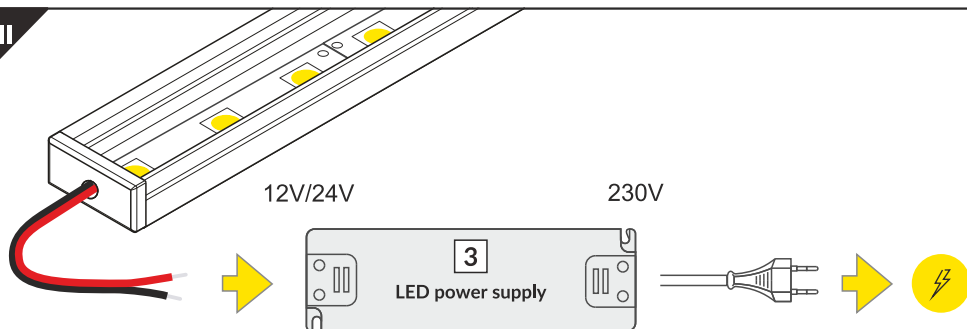

ACCESSORIES

- power switches
- controller + remote
- movement sensors



Wired 4 Signs USA
+1 (865) 339 4956
info@w4susa.com
7669 Clinton Highway, Powell,
Tennessee, 37849