

HP Designjet L25500 Printer series

Service manual



For HP Internal Use Only Warranty

©Copyright Hewlett-Packard Company 2009

This document contains proprietary information that is protected by copyright. All rights are reserved. No part of this document may be photocopied, reproduced, or translated to another language without the prior written consent of Hewlett-Packard Company.

1st Edition, November 30th 2009

The information contained in this document is subject to change without notice.

Hewlett-Packard makes no warranty of any kind with regard to this material, including, but not limited to, the implied warranties of merchantability and fitness for a particular purpose.

Hewlett-Packard shall not be liable for errors contained herein or for incidental or consequential damages in connection with the furnishing, performance, or use of this material.

WARNING

The procedures described in this manual are to be performed by HP-qualified service personnel only.

Electrical Shock Hazard

Serious shock hazard leading to death or injury may result if you do not take the following precautions:

- Ensure that the ac power outlet (mains) has a protective earth (ground) terminal.
- Disconnect the Printer from the power source prior to performing any maintenance.
- Prevent water or any other liquids from running onto electrical components or circuits, or through openings in the enclosure.

Electrostatic Discharge

Refer to the beginning of Chapter 4 of this manual, for precautions you should take to prevent damage to the Printer circuits from electrostatic discharge.

Safety Symbols

General definitions of safety symbols are given immediately after the table of contents.

WARNING

The Warning symbol calls attention to a procedure, practice, or the like, which, if not correctly performed or adhered to, could result in personal injury. Do not proceed beyond a Warning symbol until the indicated conditions are fully understood and met.

CAUTION

The Caution symbol calls attention to an operating procedure, practice, or the like, which, if not correctly performed or adhered to, could result in damage to or destruction of part or all of the product. Do not proceed beyond a Caution symbol until the indicated conditions are fully understood and met.

Customer Assurance
Customer Experience Section
Large Format Printing Division
Hewlett-Packard Espanola, S.A.
Avda. Graells, 501
08190 Sant Cugat del Valles
Spain

HP Designjet L25500 Printer series



Service manual



Table of Contents

Printer System 1-1

Troubleshooting 2-35

System Error Codes 3-73

Service Test, Utilities and Calibrations 4-117

Print Quality 5-227

Ink Supplies 6-247

Service Parts and Diagrams 7-261

Removal and Installation 8-301

Preventive Maintenance 9-599

Repacking the Printer 10-607

Safety 11-625

Using this Manual

Purpose

This Service Manual contains information necessary to test, calibrate and service:

- HP Designjet L25500 42-inch Printer (Model CH955A)
- HP Designjet L25500 60-inch Printer (Model CH956A)

For information about using these printers, refer to the corresponding User Guide or Maintenance and Troubleshooting Guide.

Chapters

1 Printer Systems

Use this chapter as a reference for technical information about the subsystems, components and how they work together

Of particular importance are the diagrams included for each subsystem of the printer. They can be useful for both troubleshooting and disassembly.

2 Troubleshooting

Whenever a printer is not functioning correctly due to a fault, use the Troubleshooting chapter for step-by-step diagnosis until you arrive at the solution, which may include replacing a part.

Troubleshooting always begins with one of those two problems, so when you enter the chapter, navigate to the proper section and find the troubleshooting steps for the problem you have found.

This chapter does not cover the procedures for the diagnostic tests you must perform while troubleshooting, or the replacement procedures you must complete to fix the problem.

3 System Error Codes

This chapter contains the system error codes which are displayed on the Front Panel and EWS. Each system error code shown in the chapter has a brief description and the steps required to solve the error.

Most of the troubleshooting steps involve performing a test or a calibration, which can be found in the following chapter, before replacing any part that you suspect of causing the system error code, always perform, the test or calibration.

4 Tests, Utilities, and Calibrations

Use this chapter whenever you need to perform a diagnostic test, service utility, or service calibration. This chapter is meant to provide procedures and relevant information, not troubleshooting information. For troubleshooting information, navigate to the Troubleshooting chapter.

These procedures are described in full, so that you know any relevant values for the test, as well as information about what the printer is actually doing during the test.

The goal of diagnostic tests is to locate the root cause of the problem and the corresponding system error code or message that will provide you with logical steps to resolution.

Some diagnostic tests or calibrations must be performed after removing a component.

5 Print Quality (IQ Troubleshooting)

This chapter describes the image quality diagnostic procedures. Further troubleshooting information based on the symptom of the issue can be found in the customer document *Maintenance and Troubleshooting Guide*.

6 Ink Supplies Troubleshooting

In this chapter we describe the components of the ink supply system.

7 Service Parts

The purpose of this chapter is to detail all of the available service parts of the printer. This information is presented in tables, organized by subsystem, and includes the following:

- Official service part names
- Part numbers
- Graphics of the service parts

Use this chapter whenever you need to order a service part.

8 Removal and Installation

The purpose of the Removal and Installation chapter is to provide procedures for removing and installing service parts. Each service part has a removal procedure detailed in this chapter, and installation procedures and notes are included as needed.

Useful information like access notes and screw types (head sizes) are provided to help you work efficiently.

Whenever you remove or replace a component, check the Service Calibration Matrix at the beginning of the chapter, which tells you the tests, utilities, and calibrations that must be performed after removing or replacing a component, and in what order.

9 Preventive Maintenance

Maintenance alerts are displayed on the Front Panel and Embedded Web Server whenever maintenance is required. While most of these alerts can be resolved by the customer, some require a service engineer.

Use the preventive maintenance chapter whenever you need to perform a preventive maintenance procedure due to an alert the customer receives from the Front Panel or Embedded Web Server, or to get reference information on life counters and maintenance that must be performed by the customer.

10 Repacking Instructions

The printer is large and depending on the scenario, will require special actions in order to move it. This chapter covers the four primary moving scenarios:

- Within the same site, over flat ground
- Within the same site, over ramps or stairs (the printer must be lifted)
- To a different site, with no possibility of freezing
- To a different site, with possibility of freezing (the ink must be removed, as it is water based and can freeze).

11 Safety

This is an industrial printer with high voltages, and it can be hazardous to service the printer. The safety chapter covers all the guidelines and checks you need to perform in order to service the printer.

Readership

The primary readers of this service manual are HP Service Engineers, although secondary readership may include resellers. All procedures must be performed by HP Service Engineers or Authorized Service Delivery Partner, except for those procedures clearly marked otherwise.

Conventions

References

Any time you are referred to another part of the manual, you will see that the text is underlined and colored green. If you are viewing the document in the form of a PDF, you can click on one of these references to go directly to the heading and page where the content is located.

1 Printer systems

- Electrical system 2
- Substrate path 11
- Ink Delivery System (IDS) 17
- Scan Axis and Carriage 19
- Service Station and Waste management 22
- Heating system 26
- Front Panel 33

Electrical system

Description

The electrical system controls all the printing systems and the heating systems inside the printer. Most parts of the control electronics are placed inside the 'E-box'.

Components

The electronics can be divided into different functional subsystems and will be described in such a way. There are 6 functional subsystems within the electronics, Front panel, Substrate path, Scan axis, Service Station, Ink Supply and Dryer and Curing.

- **E-box:** Main electrical control system of the printer, used for processing and controlling the various printer elements.
 - **Front Panel:** The Front Panel receives its control and power from the Interconnect PCA.
 - **Substrate Path:** Controls the substrate movement.
 - **Scan Axis:** Pen firing control and sensors for color and paper detection.
 - **Service station:** Maintenance of the Printheads.
 - **Ink supply:** Control of ink.
 - **Dryer and Curing:** Infrared (IR) Sensors and Heaters for Latex ink.

Circuit diagram

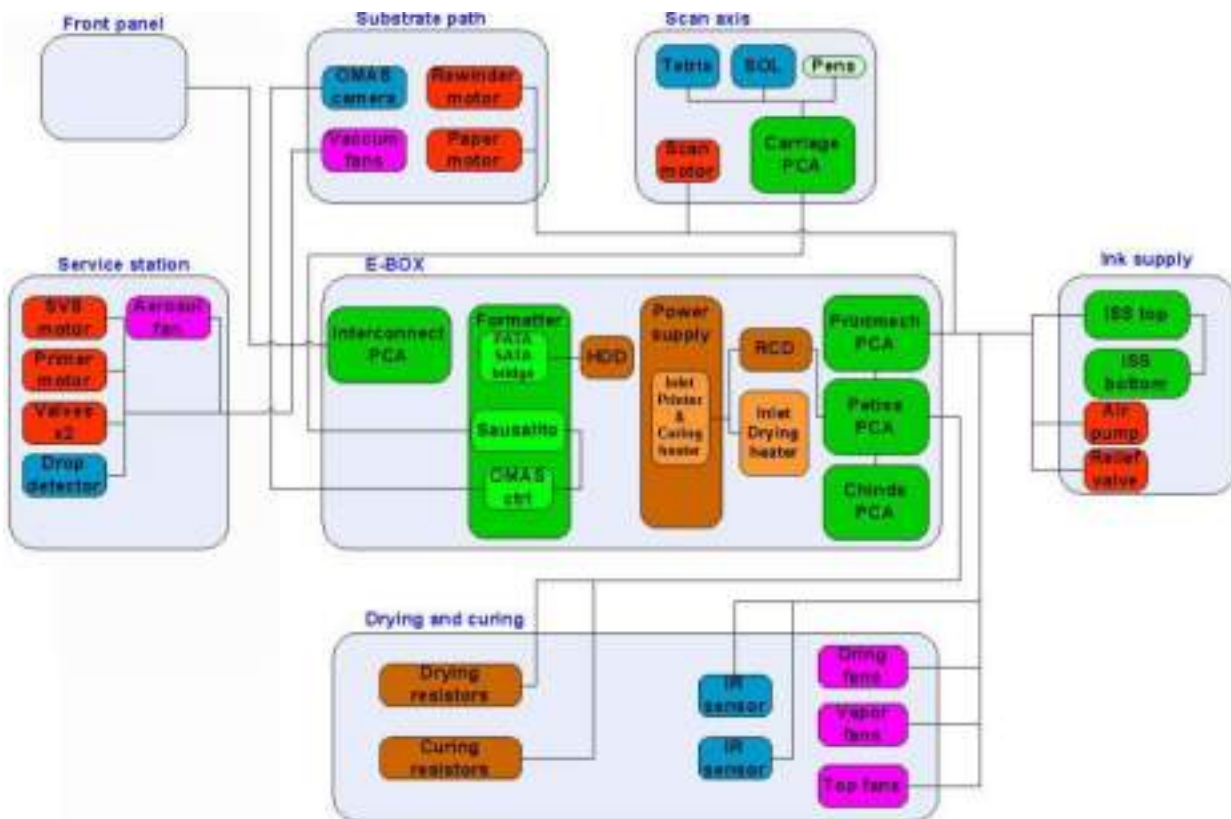

E-box

Description

The E-Box contains all the electronics except for the Ink Supply and the control of the firing of the Printheads which take place outside the Ebox.

Components

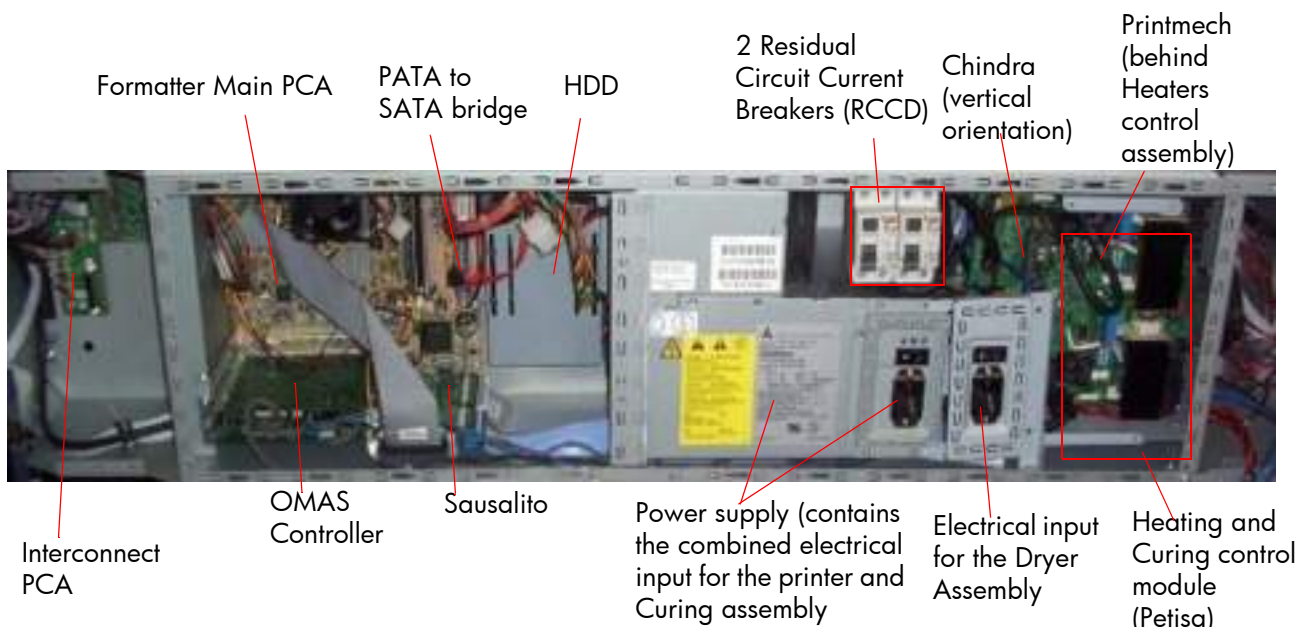

Functionality

Formatter Main PCA

The formatter is the motherboard of the printer, referred to as the Main Board and is the same type as for a standard PC.

PATA-SATA bridge

The Main Board does not support SATA hard disk drives and a converter board is used to convert from serial data to parallel data.

Hard Disk Drive (HDD)

The HDD contains the firmware of the printer.

- The operating system is based on Montavista's embedded Linux system.
- All calibration values, product number, serial number etc, are stored on the Hard Disc Drive. In order to make sure that this information is not lost in the case of a failure of the HDD, a backup is made in the ISS top board



NOTE: In order to prevent any loss of calibration values do not replace the following at the same time

- Do not replace the Hard Disc and the ISS Top Board.
- Do not replace the Hard Disc and the Main Interconnect Board

Sausalito PCA

This board is the main controller of the printer, it is responsible for all the processes performed in real-time and are the ultimate controllers of all electromechanical systems. Sausalito controls all substrate path

components (Drive Roller, Spindle Motors, OMAS, etc.) and all non-substrate path components (Carriage, Scan Axis Motor, Dryer and Curing Heaters, Print Head Cleaning Assembly, Service Station, etc).

Printmech

The 'printmech' PCA is mainly used to control motors and fans but it also controls the following:

- Scan motor
- Paper motor
- Rewinder motor
- Ink valves
- Ink pressurizing pumps
- Top fans
- Dryer fans
- Curing fans
- Web-wipe
- IR sensor
- IR Fan

The Interconnect PCA

The Interconnect PCA controls several motors and is also used as a connections board for some of the functionality that resides in Printmech board.

- Take-up reel
- Vacuum fans (passes through, the actual control is inside Printmech)
- Front panel
- TOMAS (temperature sensor for the OMAS sensor)
- Valves
- Paper Jam Sensor

Heater Control Board (Petisa)

The Heaters Control Board (Petisa) is a high voltage board with TRIACS, relays, current sensors and safety components for the external heaters. It has its own Enclosure for safety protection.

Chinda

Chinda board controls the TRIACS and interfacing with a digital interface. It is installed vertically into the Petisa board.

In order to avoid incorrect installation this PCA has a tab, which must be correctly aligned with the Petisa board before being fully installed.

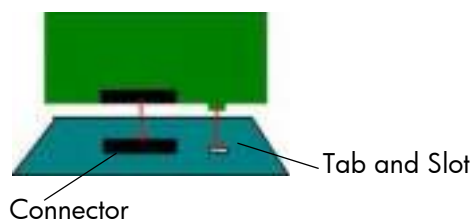

Residual Circuit Current Breaker (RCCB)

To protect the printer and the users, there are two Residual Circuit Current Breakers (RCCB) which are connected between the two power inputs and the Heater Control board. They detect a current leak greater than 30mA. The customer can reset the RCCB if a circuit blows, but a frequent reoccurrence would indicate an electrical failure in one or more of the heaters.

Printer/Curing Assembly Power supply

The power supply converts the AC input of the following skus:

- 42inch Printer: 200-240VAC
- 60inch Printer: 220-240VAC

They are converted to voltages that can be used internally in the 'E-box' for driving the electronics, motors etc. This input is also used by the curing heater.

Power Input for the Dryer Assembly

This input is solely used by the resistors in the Dryer Assembly.

Circuit diagram

The following diagram shows the connections between the components and the ebox.

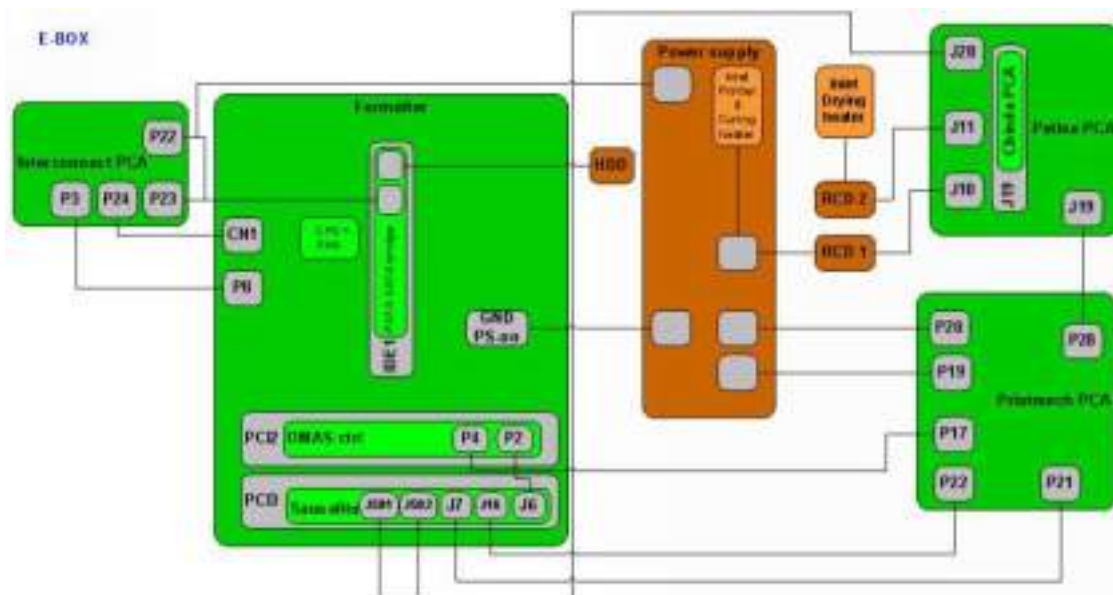

Carriage Electronics

The Carriage contains the electronics for controlling and firing the Printheads. It also contains electronics for controlling the external sensors (SOL and Tetris) as well as the Scan Axis Encoder.

The electronics of the Carriage receives power and data from the Trailing cables, which conveys both Power (+45V) and Data (LVDS) cables. The Power cable connects the Carriage with the Printmech board and Data cable connects Carriage with the Main (Engine) board)

Components

Carriage PCA

The Carriage PCA contains the electronics to control how and when the ink is dropped in every print head and receives the information from the sensors.

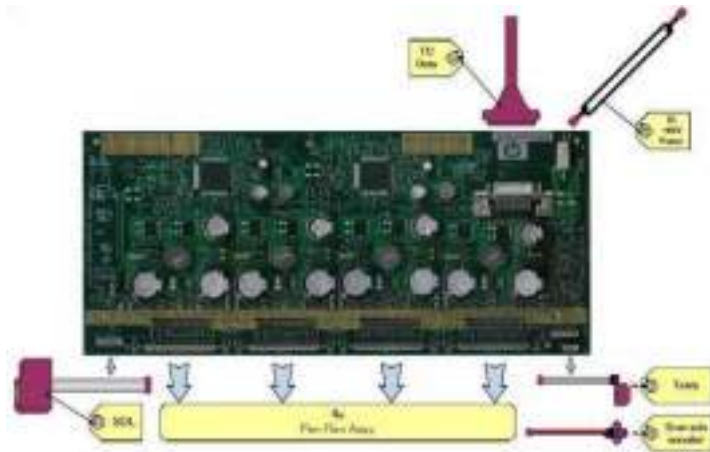

SOL Spectrophotometer

The SOL is a color sensor located on the left side of the Carriage. A metal sheet protects the SOL from the high temperatures produced by the Dryer Assembly. The main function of SOL is to measure color samples that have been printed on the loaded media and then are placed on the print platen zone.

Before taking any color measurement, the SOL must be initialized. The SOL initialization process takes approximately 7min. This process consists of three steps:

- Sensor switch on
- Sensor warm up
- Sensor calibration.

When the initialization process has finished, the shutter opens automatically and the Carriage is moved along the Scan Axis to place the SOL on top of each sample to take a color measurement. After the measurements, the shutter is closed again and the sensor is switched off.

Tetris

Tetris is used to align the printheads as well as to locate and measure a media size and edges. The alignment procedure consists of a series of patterns first being printed, then scanned using the Tetris, and finally an internal process is used to correct the timing of when and where the nozzles of the Printheads fire, and detect any possible nozzle-out issues.

Scan axis encoder

The line encoder is located on the Carriage and this measures and counts the movements of the Scan Axis. An optical, infrared wavelength encoder is used, this is the same type of encoder used in most of the HP large format printers. The Encoder signal is converted to LVDS logic levels and directly routed through the Data TC.

Pen Flex

To connect the Carriage to the Printheads, a delicate flexible circuit with small golden dimples is used. Printheads are inserted into unique slots and a spring loaded mechanism pushes the electrical contacts of the Printheads into the Printhead flex, which subsequently connects the Printhead to the Carriage electronics. Printheads Flexes are the most delicate and sensitive part of the Carriage. If the Printheads are inserted with too much force or they are misaligned, the insertion can easily damage them.

Ink Supply Station (ISS) Electronics

Description

The ISS electronics is powered from a +12V line coming from the PrintMech, and a linear regulator on the ISS PCAs generates the +5V used to power all the devices on the board.

The ISS PCAs are two electronic PCAs located on the rear of the Ink Supply Station. The ISS PCAs provide the following:

- Pressure Ink Level Sense (PILS) measurement.
- Ink supply presence detection.
- Ink Cartridge broken bag detection.
- Ink supply smart chip interface.
- Air pressure measurement and air pump shutdown.
- Humidity and temperature measurements.
- System back-up EEPROM.

Components

Below is a picture showing the connections and components located at the rear of the ISS.

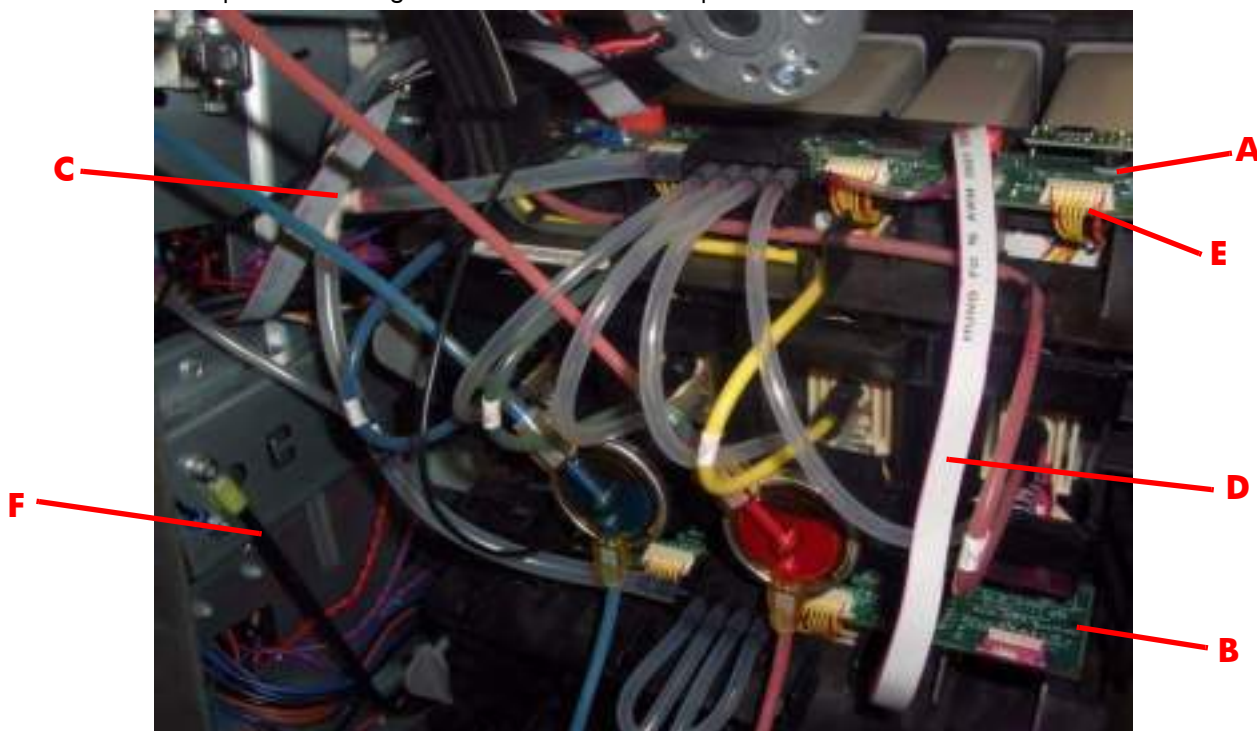

Marking	Description
A	ISS Top PCA
B	ISS Lower PCA
C	ISS to Printmech cable
D	ISS Top to lower cable
E	ISS Supplies cable
F	ISS Ground cable

Top and Lower ISS PCAs

Both top and lower ISS PCAs share the same PCB, the only difference between them is that the lower PCA is a simplification of the top PCA, the top PCA contains these additional parts:

- EEPROM
- Connection from the Printmech
- Air pressure sensor

- Temperature and Humidity sensor

Both PCAs are connected through an 8-pin connector. The 2nd ISS connector is connected to the PrintMech in a daisy-chained connection the 1st ISS board by means of this 8-pin connector.

All the board functionality is controlled by means of two I2C buses: PILS_I2C and ACU_I2C. The bus controllers are inside the ASIC, placed on the main PCA.

The PILS_I2C bus is operated at 400 KHz and the devices connected to it are an I/O Expander, an ADC and the Back-up EEPROM. The functionality of each of these devices is explained below.

- I/O Expander: Used for Presence and Broken Bag detection. It generates an interruption each time a presence event or a broken bag event occurs. This interrupt line is taken to an Impact GPIO. The I/O expander also controls the multiplexers for the PILS measurement circuitry and the Acumen interface. The device contains 16 I/O ports.
- ADC: This measures the PILS signal, and the signals coming from all the sensors on the PCA, i.e. temperature, humidity and air pressure sensors. It is a 12-bit, 8-channel A/D converter.
- EEPROM: 32KByte memory for storage of tubes and system back-up information (NVM).

The other I2C bus, the ACU_I2C, is operated at 100 KHz and it is used to communicate with the Ink Supply Acumen. This bus is multiplexed on the ISS board through an analog multiplexer.

The ISS is connected to the PrintMech through a 10-pin connector. The pins-out of this connector are listed in the following table, together with a description of all the signals:

Pin #	Pin Name	Description
1	GND	Ground.
2	+12 V	12 Volts to power the ISS board.
3	ACU_SDA	Data line of ink supply I2C acumen interface.
4	ACU_SCL	Clock line of ink supply I2C acumen interface.
5	PWM_OFF	Signal to shut down air pump PWM in PrintMech in case of overpressure.
6	ISS_INT	Interrupt to alert Impact of a presence detection or broken bag event.
7	ADDR	Signal sets the I2C slave address of ISS devices and allows for expandability in case a 2nd ISS board is needed for a future product.
8	PILS_SDA	Data line of the PILS I2C interface.
9	PILS_SCL	Clock line of the PILS I2C interface.
10	GND	Ground.

Besides the PrintMech connector, there is an 8-pin connector to allow for expandability with the 2nd ISS board (lower PCA). The 2nd ISS connector is connected to the PrintMech in a daisy-chained way through the 1st ISS board (top PCA) by means of this 8-pin connector. The pins-out of this connector are listed in the following table, together with a description of all the signals:

Pin #	Pin Name	Description
1	GND	Ground.
2	+12 V	12 Volts to power the ISS board.
3	ACU_SDA	Data line of ink supply I2C acumen interface.
4	ACU_SCL	Clock line of ink supply I2C acumen interface.

5	ISS_INT	Interrupt to alert Impact of a presence detection or broken bag event.
6	PILS_SDA	Data line of the PILS I2C interface.
7	PILS_SCL	Clock line of the PILS I2C interface.
8	GND	Ground.

Circuit diagrams

A simplified block diagram:

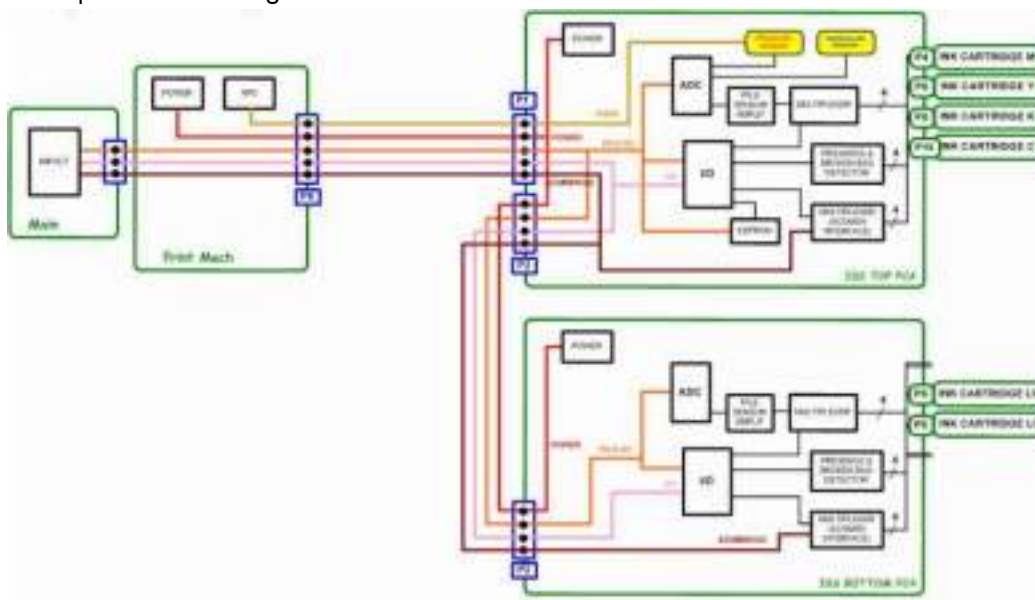

Related tests, utilities, and calibrations

- Electrical system Menu ⇒ Page 123.

Service parts

- Electronics Module ⇒ Page 268.
- Carriage PCA ⇒ Page 278.
- Left Hand Assemblies ⇒ Page 276

Removal and installation

- Electronics Module ⇒ Page 483.
- ISS Upper and Lower PCAs ⇒ Page 391.
- ISS to Cartridge Cables ⇒ Page 385.
- Carriage PCA ⇒ Page 402.
- Carriage Flex Cables ⇒ Page 405.
- Interconnect PCA ⇒ Page 435.
- OMAS Controller Card ⇒ Page 437.
- Sausalito PCI PCA ⇒ Page 444.
- Memory Modules ⇒ Page 448.
- Main PCA ⇒ Page 450
- Hard Disk Drive ⇒ Page 452
- Pata to Sata PCA ⇒ Page 454
- Power Supply ⇒ Page 456
- Formatter Battery ⇒ Page 464

- Heater Control Assembly⇒Page 465
- Circuit Breakers ⇒Page 476
- Dryer AC Input ⇒Page 478
- Printmech⇒Page 482

Substrate path

Description

The substrate path moves the substrate from the input spindle to the take-up reel, through the print path, while the Carriage prints on the substrate. The objectives of the substrate path while advancing the substrate are:

- Maintain an accurate advance
- Maintain a constant advance
- Keep the substrate flat
- Advance the substrate straight along the substrate axis

Substrate path workflow overview

The following steps describes the substrate path workflow.

1. The substrate is loaded onto the **Input Spindle** (1) which is driven by the rewinder mechanism to provide back tension to the media. The media is fed through the entry platen, around the **Drive Roller** (2), under the **Pinchwheels** (3), over the printzone and **Overdrive** (4) and finally the media is either left free or collected in the take-up reel.

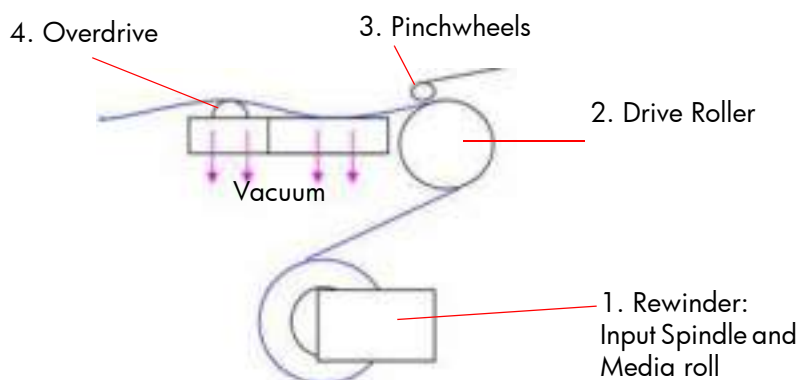

2. The rewinder has a motor that primarily acts as a brake to maintain tension on the media.
3. The drive roller also has a motor, and is the primary component that advances the substrate. The substrate is pressed to the drive roller by the pinchwheels, ensuring a smooth substrate advance. The motor receives feedback from an encoder located at the left side of the roller, inside a protected enclosure on the left of the left sideplate.
4. The surface of the substrate path where the substrate is printed is called the print platen. The print platen is designed to give minimal resistance to the substrate advance, and includes suction holes which apply vacuum to the substrate.
5. The vacuum, is calibrated according to the substrate type and print options used, it draws the substrate to the print platen, making sure that the substrate is flat. The media is also under the dryer when it is in the print zone.
6. The area of the platen in front of the print zone holds the overdrive wheels. This area also has vacuum to ensure traction over the wheels, which are connected to the drive roller through a set of gears. The overdrive wheels help to remove the substrate from the print zone during the substrate advance.
7. After the platen, the substrate goes through the curing zone and finally leaves the printer, either to be collected on the take-up reel or to be cut.
8. The printer detects and controls the substrate's advancement. The OMAS sensor, located on a special cut-out section of the print platen, is a sensor which is able to detect very small errors in the advancement of the media. These advancement errors are communicated to the motors on the driver roller and small corrections adjustments are applied to the movement of the substrate.

Under the same area, but not visible from outside the printer, there is the TOMAS sensor which measures the temperature in the area and helps OMAS to provide the drive motors with a higher degree of accuracy.



NOTE: The OMAS sensor cannot see the fibers on some substrates, such as transparent media or very dark or very reflective substrates. In these cases, the OMAS sensor can be disabled. To disable the OMAS sensor ⇒ See page 189.

Startup, substrate load, substrate selection

During startup, the printer checks that the substrate path components are functioning correctly. When shutting down, if a substrate is loaded, the printer remembers the substrate definition. This may be modified through the front panel with the option 'Change loaded substrate' from the substrate menu list.

During substrate loading the printer may ask the user two interactions:

1. To rewind manually the media: The printer automatically checks the direction of the loaded media (printed face outwards or printed face inwards). If the 'curve' of media is too large the printer cannot detect it and the printer asks the user to rewind manually. Once the media is rewound the printer can detect automatically.
2. To align the substrate in order to avoid skew: the printer measures skew. If the skew is too large the printer will ask the user to lift the pinchwheels (big blue lever on right hand side) and align the substrate. The substrate must be aligned against itself (media edge must be aligned with input roll edge).

Components

Spindle



The spindle can load 3" core rolls. It holds the core of the roll when its rubber bands are nipped between the core of the roll and the aluminum extrusion.

The hub on the left side has two possible fixed positions: the end position allows loading maximum width rolls, but there is a second position at 2.6 inches (65mm) from the end that can be selected.

The right hub can be set along any length of the spindle so any length of roll can be loaded.

The right end of the spindle contains a gear which is used to transmit the movement from the rewinder to the roll.

Loading table



Loading table

You can use the loading table as a working surface to load the substrate roll onto the spindle. In order to position the spindle, use the two slots on the right hand side. Right hub should go inside one of them. Then, by rotating the table towards the machine, the roll will go to its final position with a small amount of effort. The user is asked to check that both spindle ends have entered into the final positions.

Spindle latch

The spindle latch prevents the media roll from slipping from its position when printing. It is not necessary to close it when inserting the spindle, it closes automatically. But the user must lift the small blue lever in order to release the spindle and extract the roll of media.

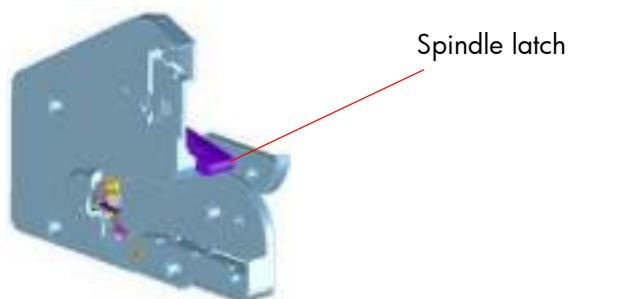

Rewinder

The rewinder motor keeps a constant tension on the input media to prevent skew problems. There is a motor and a transmission that gives torque to the spindle in order to provide the necessary back tension.

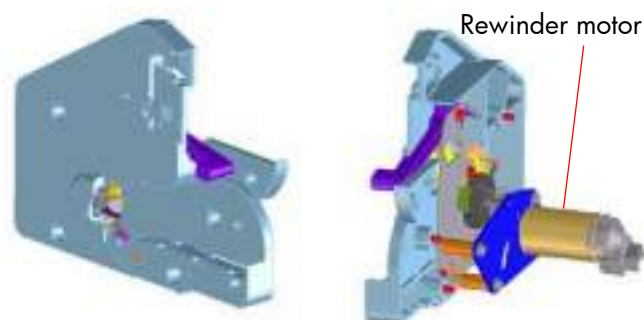

Media sensor

The entry platen has a lever that activates the media sensor whenever media is present. When the substrate is inserted into the entry area, the sensor is activated and the drive roller starts turning to help the loading process. The media load process has been triggered and the printer will provide instructions through the front panel.

OMAS sensor (substrate advance sensor)

OMAS is located under the third platen slab from the right, only the top window can be seen:

OMAS is composed of two parts: the sensor and its optics located under the platen and a PCI control board on the main electronics box. Both are connected through a ribbon cable that runs through the vacuum beam, by the right sideplate and into the electronics box.

The optical sensor detects the surface of the back of the substrate as it moves across the platen. The sensor is able to evaluate the exact movement of

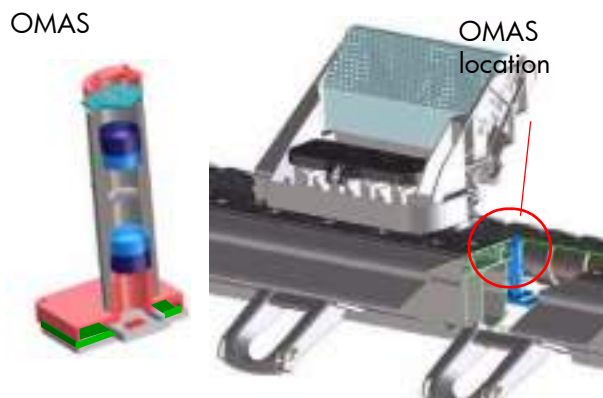

the substrate, and communicate any small adjustments required by the system to move the substrate smoothly.

The window of the OMAS sensor must be cleaned of dust and ink to functioning correctly. The cleaning procedure for this is described in the customer document '*Maintenance and Troubleshooting guide*', in the section called 'Clean the substrate advance sensor window'.

During the substrate load, the printer detects that the substrate has reached the print platen when the OMAS captures its image.



NOTE: The OMAS sensor cannot detect the surface of some substrates, such as plastic or very dark substrates. In these cases, the OMAS sensor must be disabled, and instead the printer uses feedback from the Driver Roller encoder to calculate the substrate advance. To disable the OMAS sensor, locate the OMAS Sensor selector from the print options menu of the RIP and set it to OFF. This can also be done from the Service menu ⇒ Page 189.

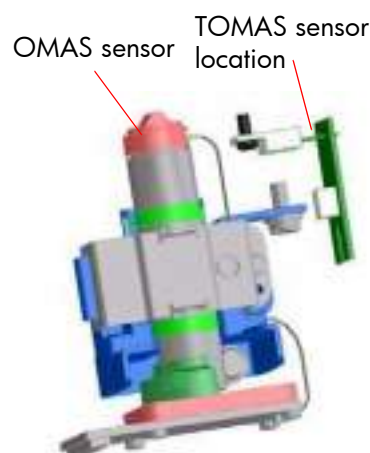

TOMAS

To compensate for temperature changes and mechanical expansion, OMAS receives a temperature reading from TOMAS sensor.

Drive roller and motor

The drive roller and motor advance the substrate through the substrate path. The motor requires 24 V, and is controlled by the Printmech PCA.



Drive Roller Encoder Disc and Encoder PCA

The Drive Roller Encoder Disc and Encoder PCA provide the feedback system for the Drive Roller.

- The Encoder disc is a round disc mounted to the left end of the Drive Roller.
- The Encoder PCA is mounted with a sensor that reads the encoder movements of the disc (the disc turns with the drive roller).

Pinchwheels

The pinchwheels press the substrate against the Drive Roller to make sure that the Drive Roller can advance the substrate correctly.

- The pinchwheels are activated with the blue lever at the right side of the media roll and usually do not have to be lifted unless to correct skew during substrate load or to clear jams.
- The pinchwheel system has a sensor that detects if the system is up or down.

Vacuum Pump, Vacuum Tube Assembly, Vacuum Beam

The print zone is the area of the media path where the transmission of ink to the substrate occurs. The main function of the system can be defined as providing the surface where the media is printed, keeping it controlled during the process, playing a main roll on the final IQ of the plots and on the operational reliability of the printer. The subsystem is composed of the print platen assembly (including the overdrive wheels), which is the physical interface with the substrate, and the vacuum system which is the mechanical system where the vacuum pressure used to control the media is generated and conducted.

The HP Designjet L25500 printers requires a hot print zone (with additional airflow) to allow the evaporation of the majority of the water in the latex inks. This feature, plus the new media supported, changes a little the main contributors of the cockle control and media expansion from the former products and also adds new issues such as the thermal marks. The platen gives a convenient shape to the heated media, avoiding differential temperatures because of platen conductivity.

The main components for 60" SKU are:

- OVD & Platen assy 60 including:
 - 7 DJ25500 printer platen + 1 OMAS platen + 1 interplaten 60 + 1 platen right end + 1 platen left end
 - Linear blade 60 + springs (same as DJZ6100)
 - OVD shafts and wheels (same as DJZ6100)
 - Foams, foam fillings and foam wall
 - ESD brushes
- OVD gears (same as DJZ6100)
- Vacuum Fan Assembly shown below (same as DJZ6100)

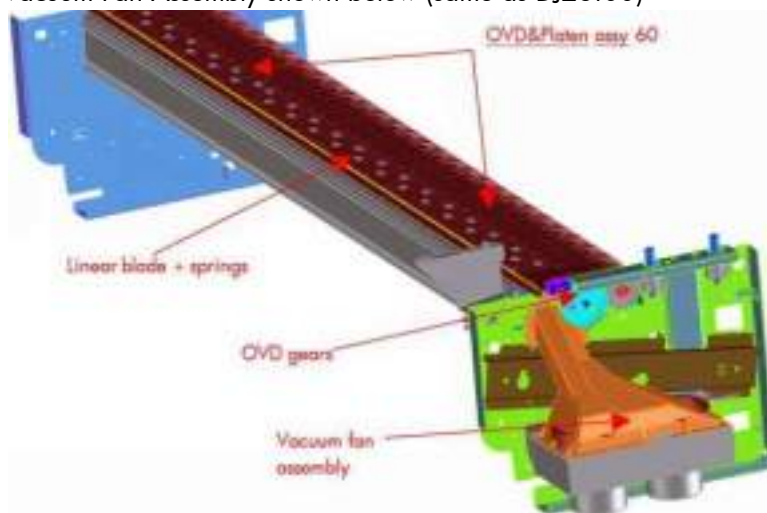

- OVD & Platen assy 42 including:
 - Five DJL25500 platen + 1 OMAS platen + 1 platen right end + 1 platen left end
 - Linear blade 42 + springs (same as DJZ6100)
 - OVD shafts and wheels (same as DJZ6100)
 - Foams, foam fillings and foam wall
 - ESD brushes
- OVD gears (same as DJZ6100)
- Vacuum Fan Assembly includes a new foam structure which improves the control of the vacuum.

Related tests, utilities, and calibrations

- Rewinder test ⇒ Page 133.
- Drive Roller test ⇒ Page 135
- Substrate Path sensor test ⇒ Page 138
- Vacuum Test ⇒ Page 142.
- OMAS Test ⇒ Page 142.
- Rewinder Motor polarity test ⇒ Page 143
- Media path menu ⇒ Page 188
- Substrate advance adjustment⇒ Page 197

Service parts

- Drive Roller ⇒ Page 288.
- Media Path Assemblies ⇒ Page 290.
- Center guide Pinchwheels Assemblies⇒ Page 292.
- Media Entry Assemblies ⇒ Page 294.
- Take-up reel Assemblies ⇒ Page 296.

Removal and installation

- Rewinder ⇒Page 361.
- Vacuum Fan ⇒Page 370.
- OMAS ⇒Page 424.
- TOMAS ⇒Page 431.
- Output Platen ⇒Page 533.
- Center Platen ⇒Page 538.
- Input Roller ⇒Page 550.
- Output Roller ⇒Page 552.
- Media Sensor ⇒Page 555.
- Pinchwheel Assembly⇒Page 565.
- Center Guide⇒Page 571.
- Driver Roller⇒Page 573.
- Rollfeed Modules ⇒Page 579.
- Take-up reel ⇒Page 582.

Ink Delivery System (IDS)

Ink Delivery System

The ink delivery system (IDS) is located in the left enclosure of the printer (inside the left covers) and delivers a continuous supply of ink to the printheads. It can detect an ink leakage anywhere in the system, including inside an Ink Cartridge. It also tracks and determines when an Ink cartridge needs replacing.

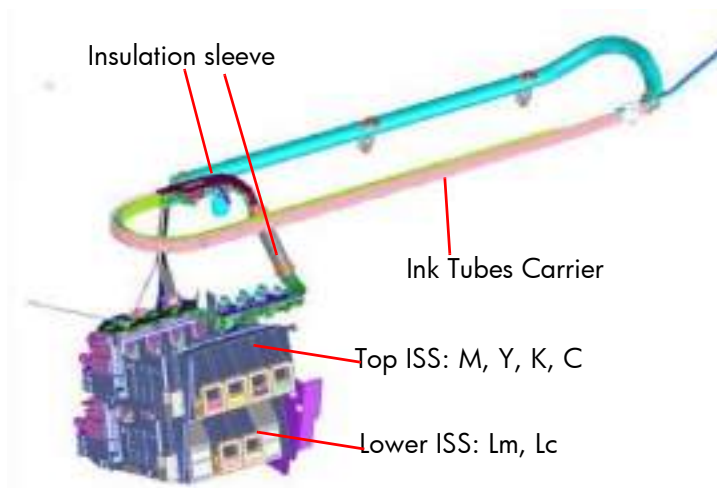

On top of the ISS there is a thin plastic sleeve to avoid the paper falling into the Ink Supply Station when a paper crash occurs and also to avoid the direct heat radiation from the dryer system

Rear of the Ink Supply Station

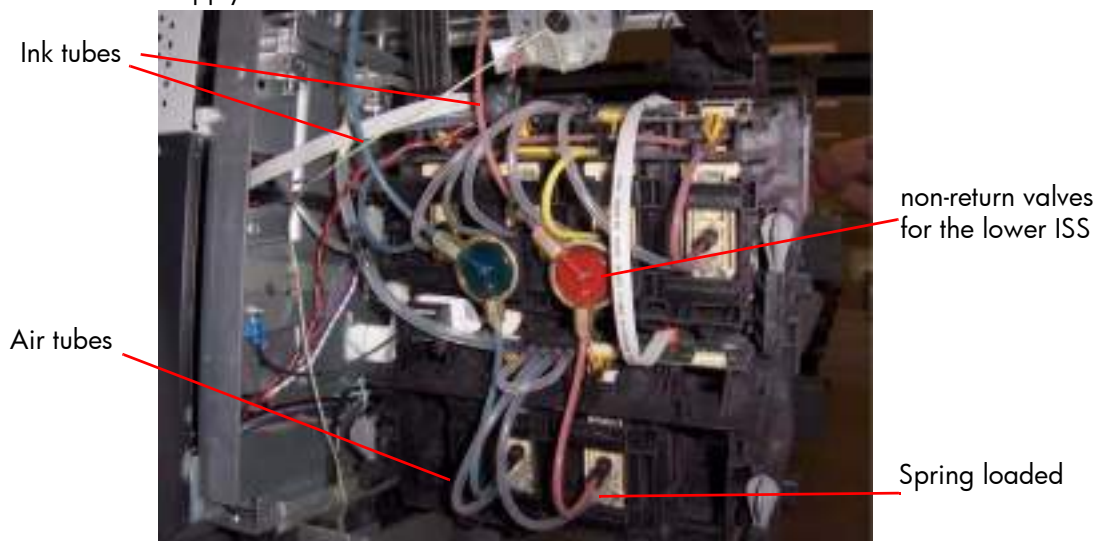

Ink Tubes

There are 6 ink tubes that deliver the inks to the printheads in the carriage and two additional tubes which are used as a support structure. They are bundled together in a carrier and held on a shelf on the inside of the top cover with clips.

Insulation Sleeve

The ink tubes are protected from the high temperatures of the Dryer Assembly by a heat resistant insulation sleeve, which protects the main body of the tubes, that are static.

Upper and Lower Ink Supply Station (ISS)

The Ink Supply Station (ISS) is divided into the upper and lower sections. They have six slots for holding the ink cartridges. Each slot has a unique shape (or lock out) which matches with an equal shape at the end of the applicable ink cartridge. This arrangement avoids the incorrect insertion of an ink cartridge, which would cause major damage to the ink system.

There are two places for additional slots but these are covered over.

The upper and lower ISS both contain PCAs, although the top PCA contains more functionality, such as the pressure sensor, see ⇒ Page 6.

Non-return valves

The two non-return valves are only for the inks on the lower IDS. This is to ensure that when the pump stops and the cartridges are nearly empty, that the ink does not flow back to the cartridge.

If a cartridge is nearly empty, with no pressure from the pump, the cartridge bag might increase, and air might enter the printhead.

With a valve, the ink can go only from the cartridge to the printhead, and not the reverse!

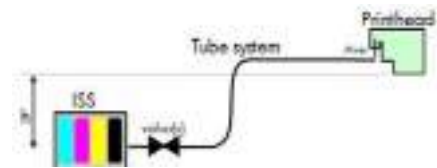

Air Pressure System (APS)

The APS contains two air pumps which are used to force the ink through the tubes to the carriage assembly. In the event of a broken bag in one of the Ink Cartridges, these tubes must be checked in case any of the leaked ink has been forced into the air tubes.

Related tests, utilities, and calibrations

- Ink Delivery System tests: ⇒ Page 146.

Service parts

- Left hand assembly: ⇒Page 276

Removal and installation

- Ink supply tubes and trailing cable: ⇒Page 380
- ISS to Cartridge Cables: ⇒Page 385
- Ink Supply Station: ⇒Page 388
- Ink Supply Station PCAs: ⇒Page 391
- APS Assembly: ⇒Page 395.
- APS Assembly: ⇒Page 395.

Scan Axis and Carriage

Scan Axis

The Scan Axis System is the part of the Scan Axis subsystem designed to move the carriage backwards and forwards for printing and servicing. This subsystem moves the carriage with a motor, belt, and pulley system. Furthermore the scan axis has features to open and close the Spectrophotometer shutter (SOL) and to enable/disable the cutter.

Scan Axis Components

Scan Beam:

It is an extruded aluminum part. Its main function is to guide the carriage along the scan axis via two rods, and it sets its limits of movement. Apart from this it positions and holds the Service Station, the Scan Axis motor, the two brackets and the pinch wheels assembly. It also works as an air container to be blown to the print zone coming from the rear and leaving through several pipes located over the media and holds the rear fans.

PPS system

The PPS consists of some screws and pockets, it locates the scan beam in reference to the side plates in order to have a correct distance between the printheads and the media. This distance is supposed to be constant during the life of the machine and it is set to be as small as possible without taking the risk the having the printheads touching the media.

Left Bracket

Left Bracket is an injected plastic part, and its main function is to set an end for the carriage movement. It also closes the scan beam to avoid the air blown to the print zone leaking. It has several features to enable/disable the cutter and the SOL shutter. The left bracket also houses the Media Jam Sensor, which works with the reflector panel on the carriage assembly to detect paper crashes. It also has some parts to ensure that the encoder strip is held with tension.

Encoder Strip

The Encoder Strip contains positional data that the encoder sensor (located in the carriage) can read and detect the position of the carriage. Since it is made of thin metal it is sharp and extreme caution is needed when handling it. Unlike previous versions, do not clean the encoder strip as this will damage it.

Right Bracket

This part is the same in the left bracket, this metallic part closes the right hole of the scan beam extrusion. It also holds the pulley assembly and the encoder strip.

Motor, pulley assembly and belt.

Their function is to transmit the position/speed to the carriage assembly.

Flat right bump

This plastic part defines the right end of the carriage movement. It is positioned and held by the scan beam.

Carriage

The carriage is the subsystem of the printer that performs the printing on the substrate. It is moved across the print path by the scan axis impelling system and with it the 6 printheads and several sensors, the Spectrophotometer (SOL), the line sensor (Tetris), the scan axis sensor. The carriage houses an on-board electronics system to send information to the 6 printheads through each of the interconnects, and it receives information from the sensors. Some parts aid the ink to arrive at the printheads. It also holds in position the cutter, used to cut some types of media.

Carriage Components

SOL Spectrophotometer

SOL is a color sensor and it is placed in the left side of the carriage, covered by a metal sheet that protects it from the heater's high temperatures. The main function of SOL is to measure color samples that have been printed on the loaded media and are placed on the print platen zone.

Before taking any color measurement, SOL must be initialized. The SOL initialization process lasts for about 7min. This process consists on 3 steps: sensor switch on, sensor warm up and sensor calibration. When the initialization has been completed, the shutter is opened automatically and the carriage is moved along the scan axis to place SOL on top of each sample to take a color measurement. After the measurements, the shutter is closed again and the sensor is switched off.

SOL is used to make the linearization from the RIP.



SOL actuator
used to open the
shutter



Carriage base

The main function of this plastic part is to located the printheads. Its position is enforced by the two rods and the belt. It serves as a base where other parts are attached and it has some features to located other components (capping station and all the next parts).

Latch assembly

This assembly holds down the printheads and helps to ensure that they do not move during operation. Once the handle is opened it can rotate to allow the user to remove the printheads. It has some features (holes) to allow the primer to pass though it and make contact with the printheads. Some parts help to transmit force to the printheads to hold them in position and to transmit information of when the ink should be dropped.

Sensors

The SOL, the Tetris and the encoder sensor sends information to the PCA board and is passed to the printmech though the trailing cable. The SOL performs a color calibration, the line sensor calibrates the printhead alignment and detects other features (e.g. the media) and the encoder sensor detects the movement of the carriage in relation to the Encoder strip.

Carriage PCA,

This part contains the electronics to control how and when the ink is dropped in every printhead and receives the information from the sensors.

PCA Cover

This part covers the PCA to avoid aerosol contamination and acts as an electronic enclosure.

X-bias springs

The X-bias springs are sheet metal parts that hold the printhead in position in the X axis.

Covering sheet and metal parts

These parts reflect part of the radiation that is received from the heater to avoid excess overheating and problems with the sensors and the printheads. Bushings, are bronze parts that are attached to the carriage base and slide over the rod

Felts, these parts help to lubricate the rod and they also avoid dirt going in between the carriage. They block four degrees of freedom (Z and Y translation and rotation over the primary rod)

SOL protectors, these parts help to avoid the SOL shutter breaking after a paper jam

Plastic rear bushing : this blocks one degree of freedom (the X rotation over the primary rod). The dam protector, are Mylar and stainless steel, and they stop the aerosol.

The plastic non-functioning pen, is a plastic part which helps keep the carriage's integrity when the latch is applied over them. Also from a usability point of view, they avoid possible mistakes when inserting the pens and have a cosmetic function too.

The airflow deflector is a part that partially stops the air entering into the print zone, it is used to avoid vapor concentration over the media that also causes "dpe" (drop placement error).

Media Jam reflector

This part is secured to the left side of the carriage assembly and works with the Media Jam sensor which is located on the Left end bracket. This is used to detect media jams.

Related tests, utilities, and calibrations

- Scan Axis Menu service tests:⇒ Page 157.
- Carriage service tests ⇒Page 161 .
- Open/close SOL⇒Page 223.
- Scan Axis Calibrations ⇒Page 213.
- Carriage Calibrations ⇒Page 217

Service parts

- Right hand Assemblies⇒ Page 274
- Left hand Assemblies ⇒ Page 276
- Carriage Assembly⇒ Page 278.
- Scan Axis Assemblies⇒ Page 282.
-

Removal and installation

- Cutter Assembly ⇒ Page 386.
- Encoder Strip and Encoder sensor ⇒ Page 399.
- Carriage Assembly ⇒ Page 408.
- Belt Assembly ⇒ Page 418.
- Scan Axis Motor ⇒ Page 419.
- Line Sensor⇒ Page 486.
- Color Sensor Assembly (SOL)⇒ Page 488.
- Color Sensor Actuator ⇒ Page 492.

Service Station and Waste management

The main function of the Service Station is to maintain the Printheads of the Carriage assembly and to manage the Waste Ink. The Service Station and Waste Management can be split into three subsystems:

- PHC servicing: Comprising Cap, wiping and priming functions
- Waste: Holds spit, ink collection and containment.
- Aerosol: Collection and filtration of aerosol generated in Spit

Components

SVS Mech

The SVS mechanics provides the movement for the Printhead cleaning Maintenance Cartridge, which integrates the capping and wiping functions and the Web Wipe assembly, which provides the means in which to advance the Web Wipe accurately.

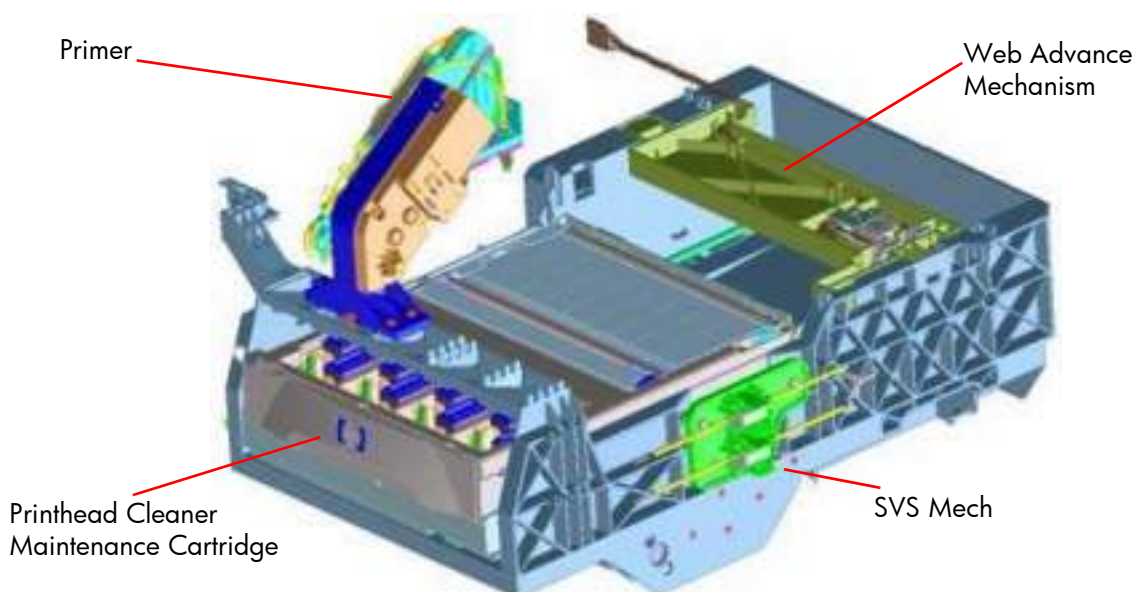

Primer

The Primer executes the blow primer functionality to the Printheads. Air pressure to perform the prime operation is drawn from the Ink Supplies, and prime pulse is controlled by solenoid valves.

Printhead Cleaner Maintenance Cartridge

The Printhead Cleaner Maintenance Cartridge is a customer consumable that holds the main components for wiping and capping. It also contains some ink priming functionality.

Drop detector

The drop detector is a sensor that analyzes the nozzle health of all the pens. The drop detector has a window where it is placed with the ink funnel. The ink funnel divides the window in two different parts, the flying spittoon and the drop detector spittoon where nozzles are fired to check their status. The nozzles out that are detected are compensated for by using other nozzles to keep a good print quality.

The drop detector has an infrared LED and a photodiode aligned in a beam light. This beam light can be blocked by the ink funnel if it is not placed correctly.

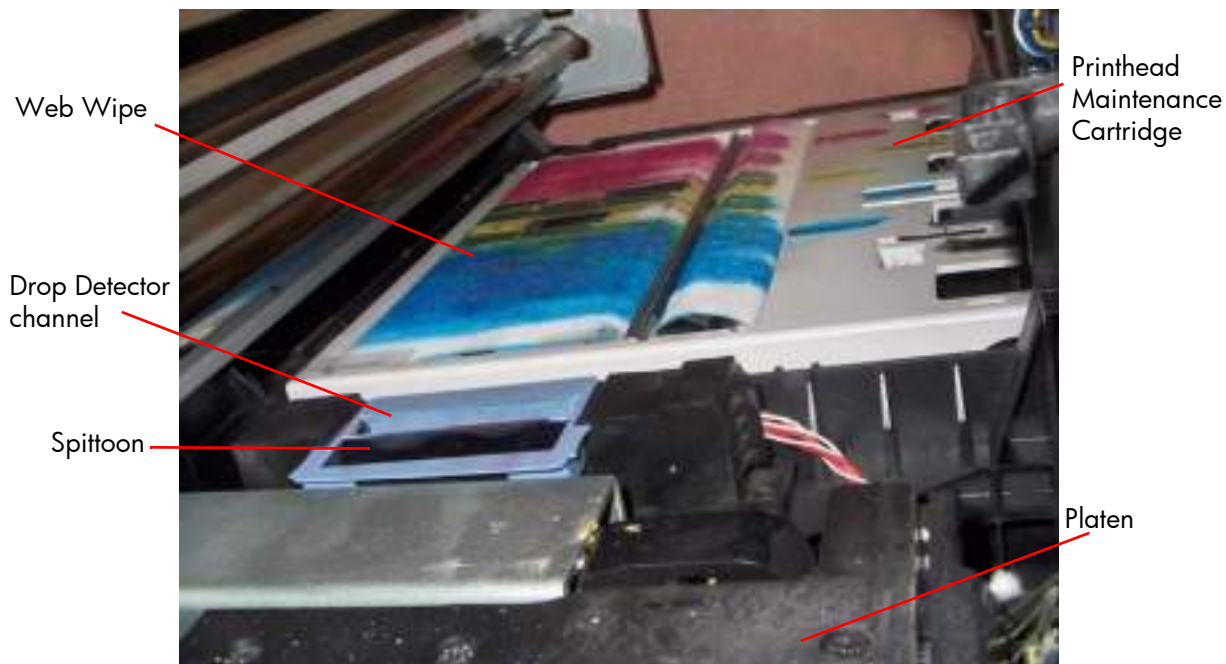

Web wipe

The Web Wipe Advance mechanism engages/disengages the advance gear of the Printhead Cleaner Cartridge. The actual advance is achieved by moving the Printhead Cleaner Cartridge once the gear has been engaged by this mechanism.

Waste subsystem

As the Printhead cleaner Cartridge does not have sufficient space to contain the waste ink, a separate subsystem provides the means to hold it. this subsystem works together with the aerosol collection subsystem.

The main components of this subsystem are:

- Ink funnel: This is the main component of the waste ink system. Its main function is to separate the main drops from the aerosol generated when the Printhead spits. The separation is done by impaction. Using the airflow from the aerosol filtration, the main drops and aerosol are accelerated in to a labyrinth path. due to the tight turn radius, the particles of high mass cannot return and impact on to the funnel wall. collecting them into big droplets that are then collected at the bottom and into the drain tube to the Printhead Cleaner Container.
- Ducting Assembly: Provides the structure and flow path for aerosol collection, thus providing the means to accelerate the particles and give the proper collection of ink.
- Duckbill valve. This is a very important component of the ink waste mechanism. It is a one way air valve, so that air cannot return back up the drain tube. This can cause an adverse condition in the waste duct, where bubbles form and then the aerosol filter may become clogged long before its expected end of life.
- Printhead Cleaner Container: This is a foam filled container to hold the waste ink. It is designed to hold a maximum of 3.3 liters of ink, and not to leak its contents in any position.

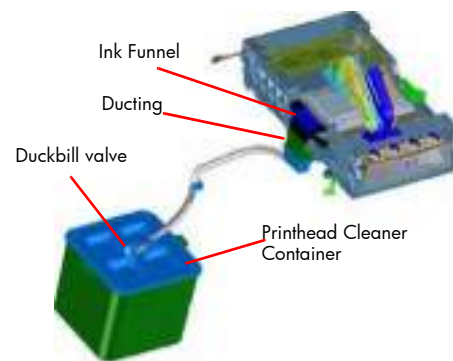

Aerosol

The aerosol subsystem collects and filters out the aerosol generated when the Printhead spits. It consists of two filters and a fan.

The impact filter is a 25 pores per inch open cell foam filter. This is designed to negate heavy aerosol and it works by impacting the aerosol droplets. The ink accumulate in this filter drains into the receptacles underneath the aerosol fan holder.

The main filter is a fiber sheet filter, designed to absorb most of the aerosol as it reaches it. To achieve a longer life out of this filter, the impact filter is placed before the main filter.

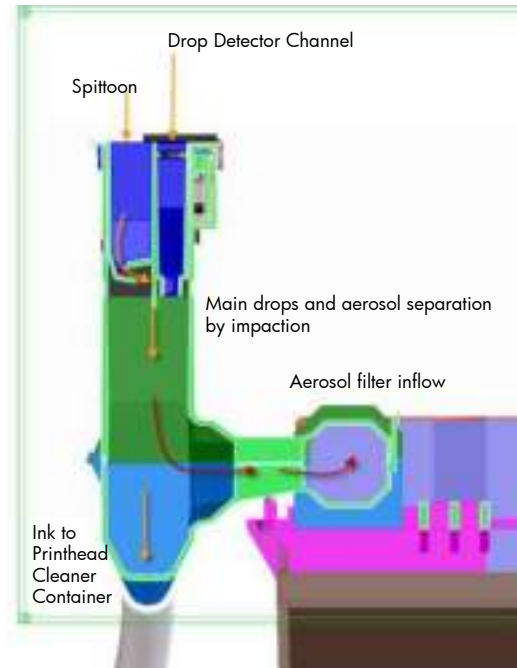

Aerosol fan.

This provides the airflow for the system to work. The fan works whenever the printer is operating. It also has a fail signal to allow the system to detect if the fan has stopped working.

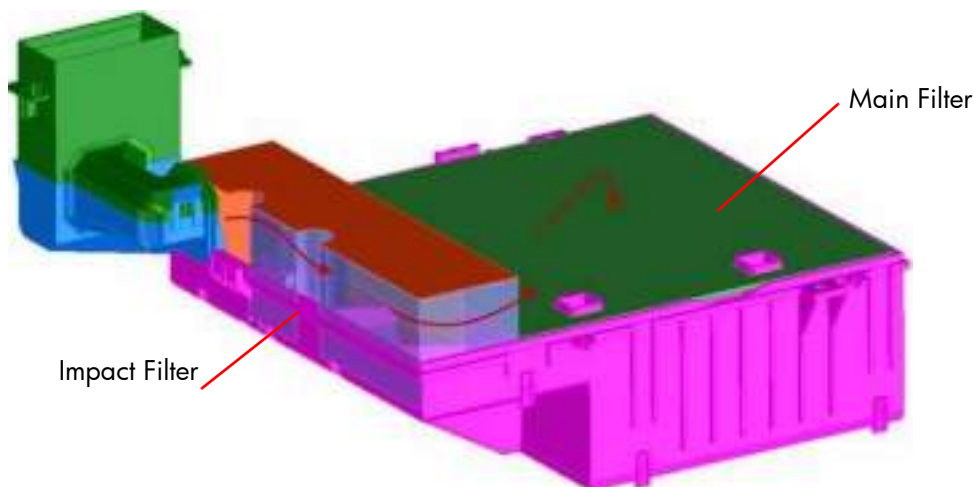

Related tests, utilities, and calibrations

- Service Station service tests ⇒ Page 163.
- Drop detector test ⇒ Page 165
- Force Drop Detector ⇒ Page 192
- Drop detection calibration ⇒ Page 216
- Service Station calibration ⇒ Page 194

Service parts

- Right Hand Assemblies⇒Page 274.

Removal and installation

- Primer Assembly: ⇒Page 355.
- Primer Valves: ⇒Page 357.
- Service Station: ⇒Page 364.
- Web Wipe Motor Assembly: ⇒Page 368.
- Vacuum Fan: ⇒Page 370.
- Aerosol Fan and Filter: ⇒Page 373.
- Drop Detector: ⇒Page 377.
- Primer Assembly: ⇒Page 355.

Heating system

The type of ink used in this printer (Latex) require heating in order for the ink to be cured. The heating system applies this heat through a Dryer Assembly and a larger Curing assembly. Temperatures are kept at a target level depending on the type of substrate and amount of ink fired via a temperature sensor, which feeds back information to the Heater Control assembly (Petisa) located at the rear of the printer.

Components

Heaters Control Assembly

The Heaters Control assembly is the controller PCA of the Dryer and Curing Heaters. The assembly is located at the rear of the Printer in an enclosure designed to shield it from the heat generated. This assembly contains the Heater Control PCA, also known as Petisa, and the Chinda board which is inserted vertically in a slot on the Heater Control board. On the side of the enclosure is a fan for cooling the system.

Dryer Module:

The Dryer module heats up the print zone to 40-55°C while printing. The main objective is evaporating most of the water content of the ink and therefore, providing the correct temperature for satisfactory image quality.

The two resistors in the dryer provide 2400W, reaching a working temperature of 650-700C while printing. Subsequently it is not safe to open the window while the unit is printing or just after the end of a plot, since the dryer cover can easily reach 200°C in intensive usage.

Curing Module

The Curing Module fixes the latex ink (cures) at typically around 80-120°C , depending on the substrate for satisfactory durability.

The two independent resistors provide a total 1900W split as follows: 1200W (Curing overdrive, closest to the printer) and 700W (Curing Output, furthest from the printer). The following cross section shows the heating subsystems:

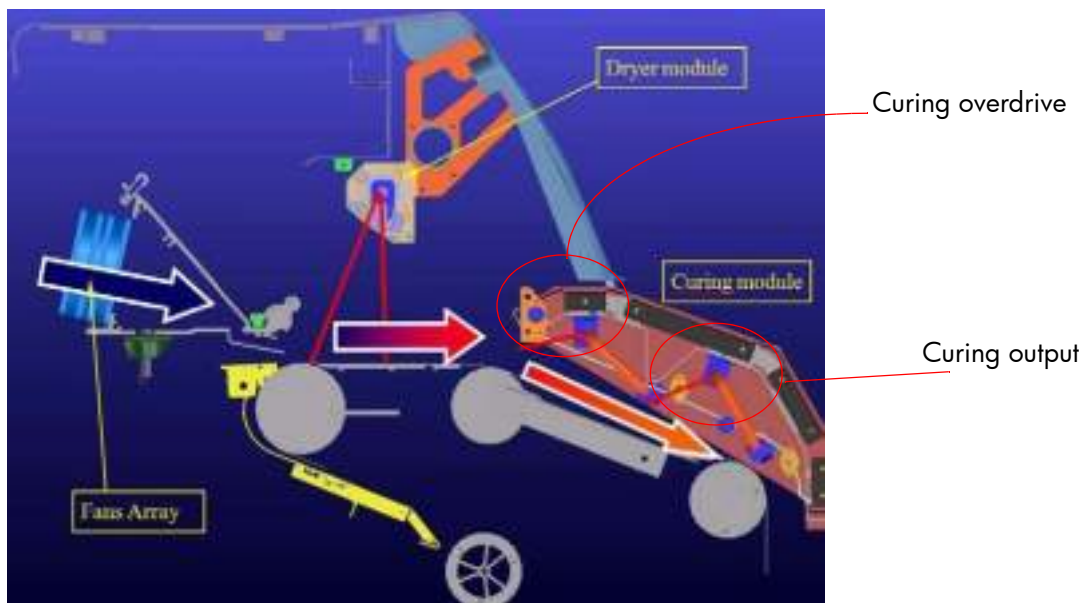

Dryer Fans and Curing Fans

The Dryer fans and Curing fans provide an airflow parallel to the media to reach a higher evaporation rate at the print zone. The airflow wipes away the vapors from the media surface, improving radiation efficiency.

The Top Cover fans blow air coming from outside of the printer to the ink tubes. This is because during printing the heat coming from the dryer to keep the paper warm also goes to the ink tubes causing an increase of the ink temperature leading to short-term damage on the printheads

The pipes that drive the air to the ink tubes are injected plastic parts. There are three different parts that form two different configuration for each of the SKU's. One configuration blows the air to the rear and the other blows it to the rear and to the front. For the 60" SKU, three assemblies blow to the front and rear and two to the rear, for the 42" SKU, two assemblies blow to the front and rear and two to the rear.

Metal Finger Guard

This is a metal guard designed to protect any fingers that should inadvertently enter into the assembly.

Cables are formed by 4 wires, two supplying the voltage (12V), one providing the PWM (5V=100% of the voltage) and one containing a fault signal

Dryer IR Sensor & Curing IR Sensor

There are two infrared sensors, one for each module, these sensors detect the temperature and feedback the information to the Heater Control Assembly (Petisa), the power supplied to each module is then adjusted according to target levels.

In the following picture a closer view of both sensors can be seen.

Dryer Module:

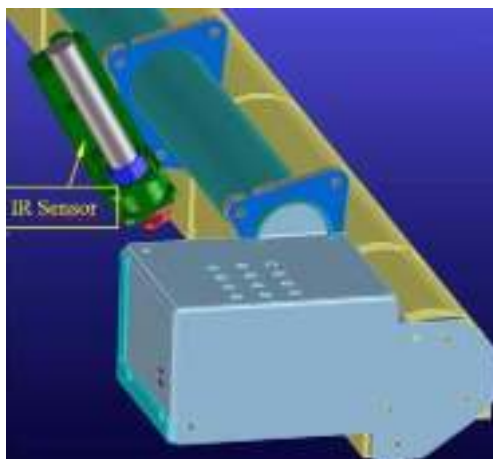

Curing Module:

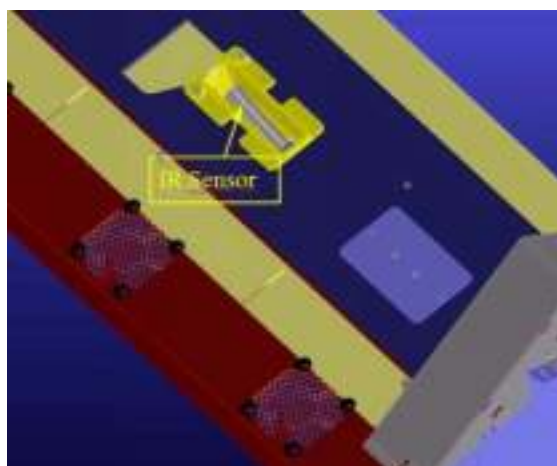

The dryer module has a unique resistor, the maximum power level is 2400W(60") while the curing module has two separate resistors for a power level of 1900W(60"). Each resistor has two coils for a better power split and therefore, better flickers performance. The 'Steady' coil is dimensioned so that it can provide most of the power requirement, whereas the 'Burst' coil provides less power to finally adjust the power level to the servo requirement.

Thermal Switches

Each module has a backup thermal switch, which in the event of an over-temperature, will physically disconnect the current from the heaters.

Electronics of the Circuit diagram

The two heating channels (Curing and Dryer) are formed by several heating resistors (R1, R2, etc) and the corresponding electronics that graduate the amount of energy supplied to these heaters, according to the orders received from the printer Servo in firmware:

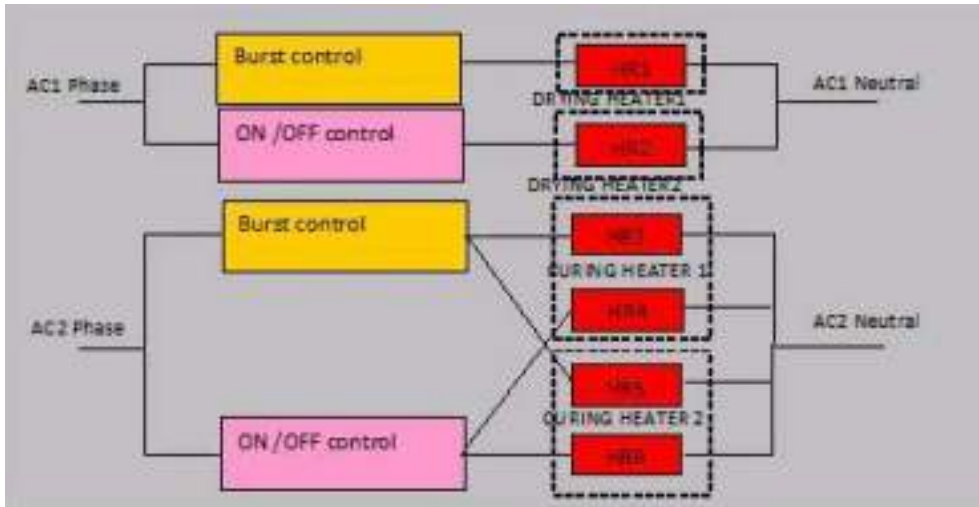

The following diagram summarizes the electronics involved in the heaters control:

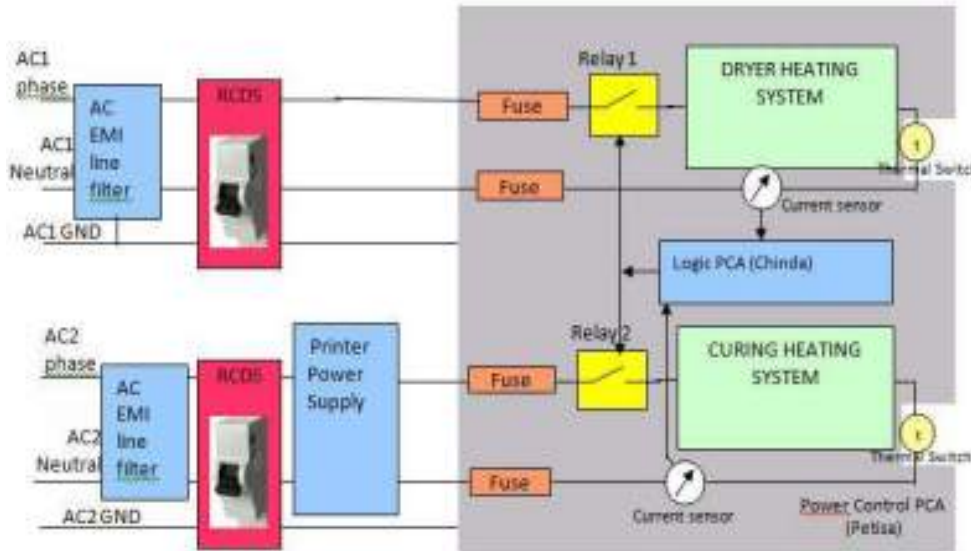

The power comes to the heating system via two different power cords, one is supplying energy just to the Dryer and the other sharing its energy between the Curing heaters and the rest of the printer electronics.

Both AC lines are internally protected by RCDS (Residual Current Sensor), that will trip and cut the AC power going into the heating system if there is a leakage to Ground above 30mA. This adds extra user safety as well as avoids potential safety hazards related to the heaters and their control.

Each channel has a Hall current sensor that supplies information to the Logic PCA, and it can decide to cut the current through the heaters if an over current is detected, controlling the Relay1 and Relay 2, placed in the Power Control PCA.

Four fuses are placed in the Power Control PCA that supplies a last, but slower, safety protection against severe electrical problems. These fuses are rated so they will not blow if the heaters are operated at 100% of power, so if they blow, a severe problem should be suspected in the heater elements or Control electronics, although big external AC surges could lead to blow fuses.

These fuses are rated 15A, slow blow (HP P/N 2110-1498, LittleFuse 326 015P)

Power control PCA

The Power Control PCA contains the relays, fuses and Triac devices that directly handle the power and the AC in the heating system.

Control Logic PCA

The Control logic PCA contain Signal conditioners, logic and I/O to take basic level decisions as well as to receive orders from the firmware to drive the Triacs , as to send back information to the firmware about different status and current levels.

Sausalito PCA

This PCA contains the Impact Asic that takes care of the process to drive the Burst heaters in both heating channels. For its proper operation it needs to know when the AC is crossing the zero voltage, and this information is supplied by the Power Control PCA.

PrintMech PCA

This PCA is used for several I/O activities between the Power Control PCA, the Control Logic PCA and the firmware.

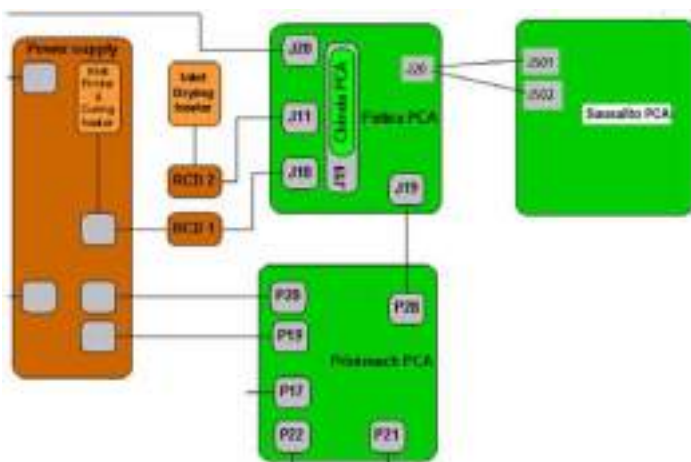

This the block diagram shows further the interaction between the different elements.

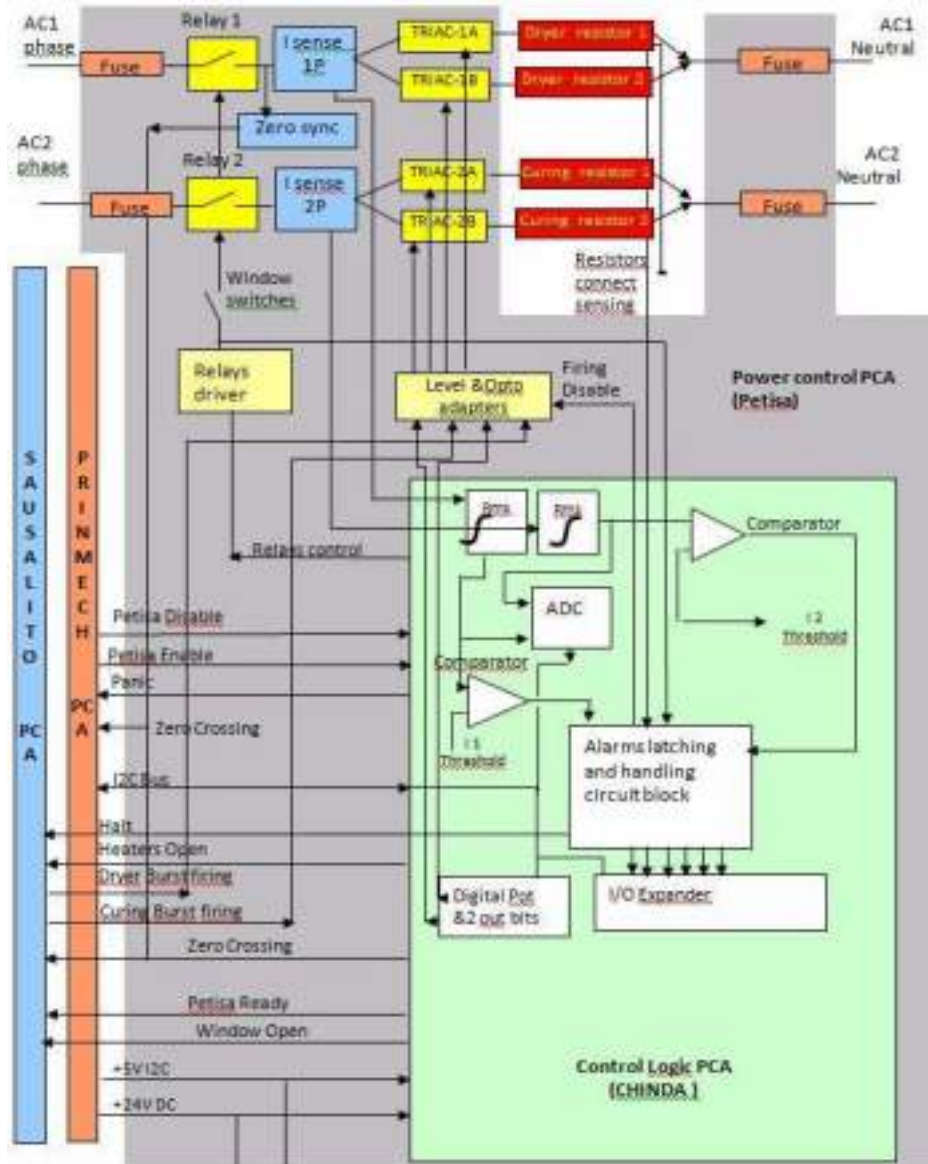

Cabling System

Heaters and electronics are connected by a cabling system:

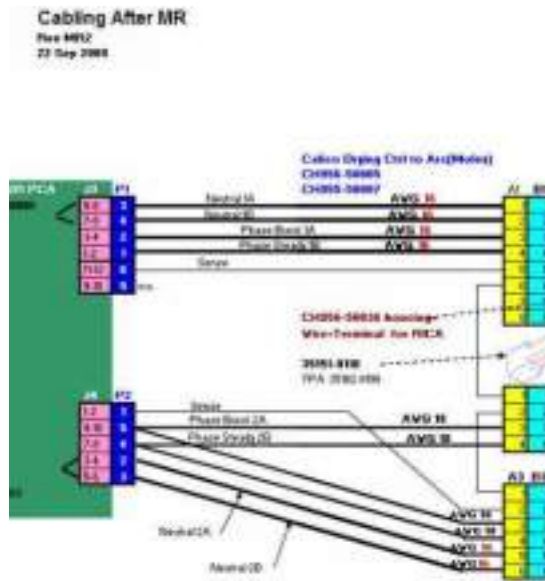

In this cabling drawing it can be seen the connections between the main components of the heating system.

Due to the physical printer structure, an interconnect is required between the lines coming from the Power Control PCA and the heating elements.

Note the green line in the diagram, this cable goes across all these intermediate connectors which allow you to detect if any of them are disconnected.

Also it can be seen that there are two thermal switches that can cut the power flowing to the heaters if there is an over temperature.

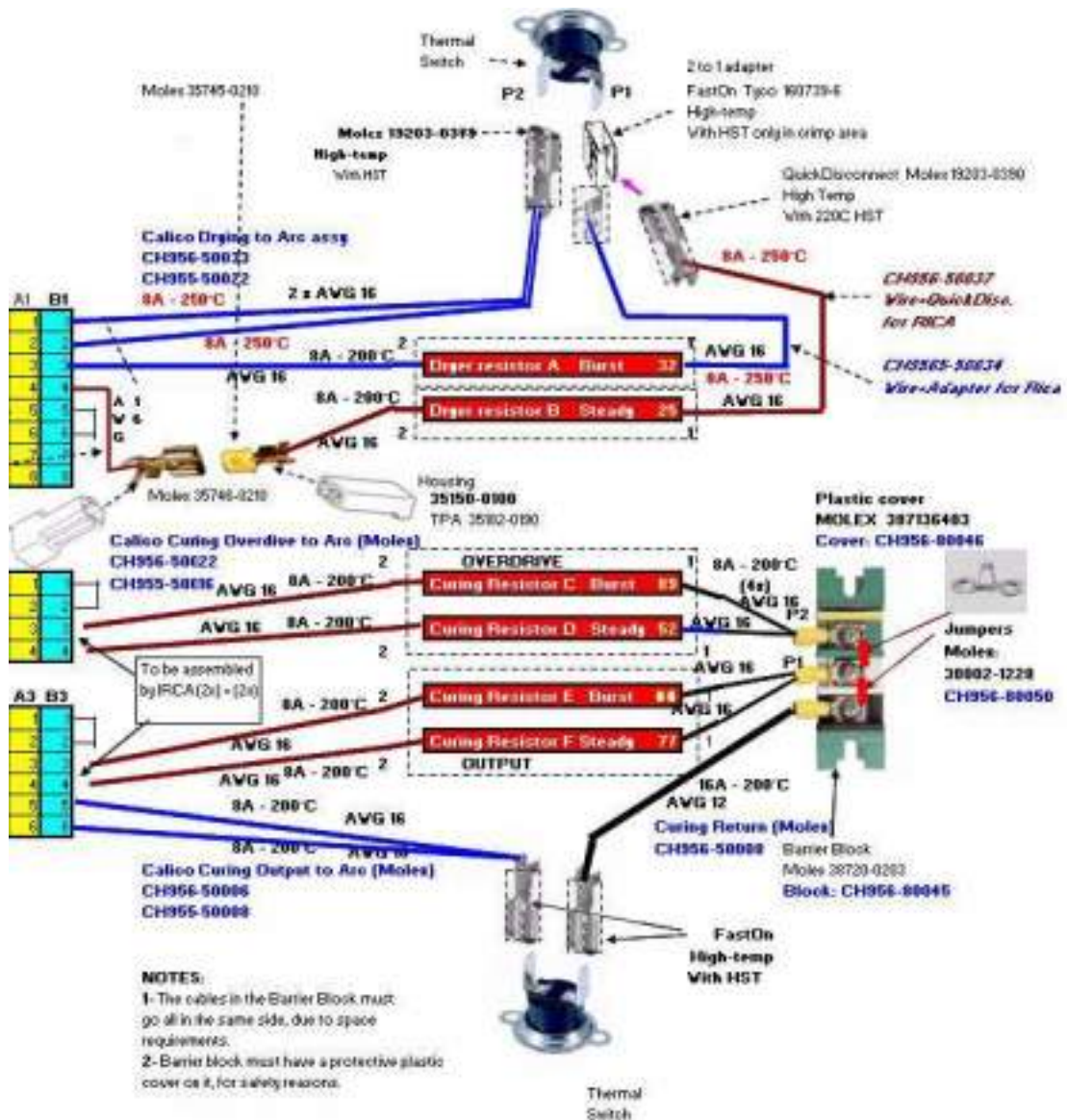

Heating and Curing PCA and connections

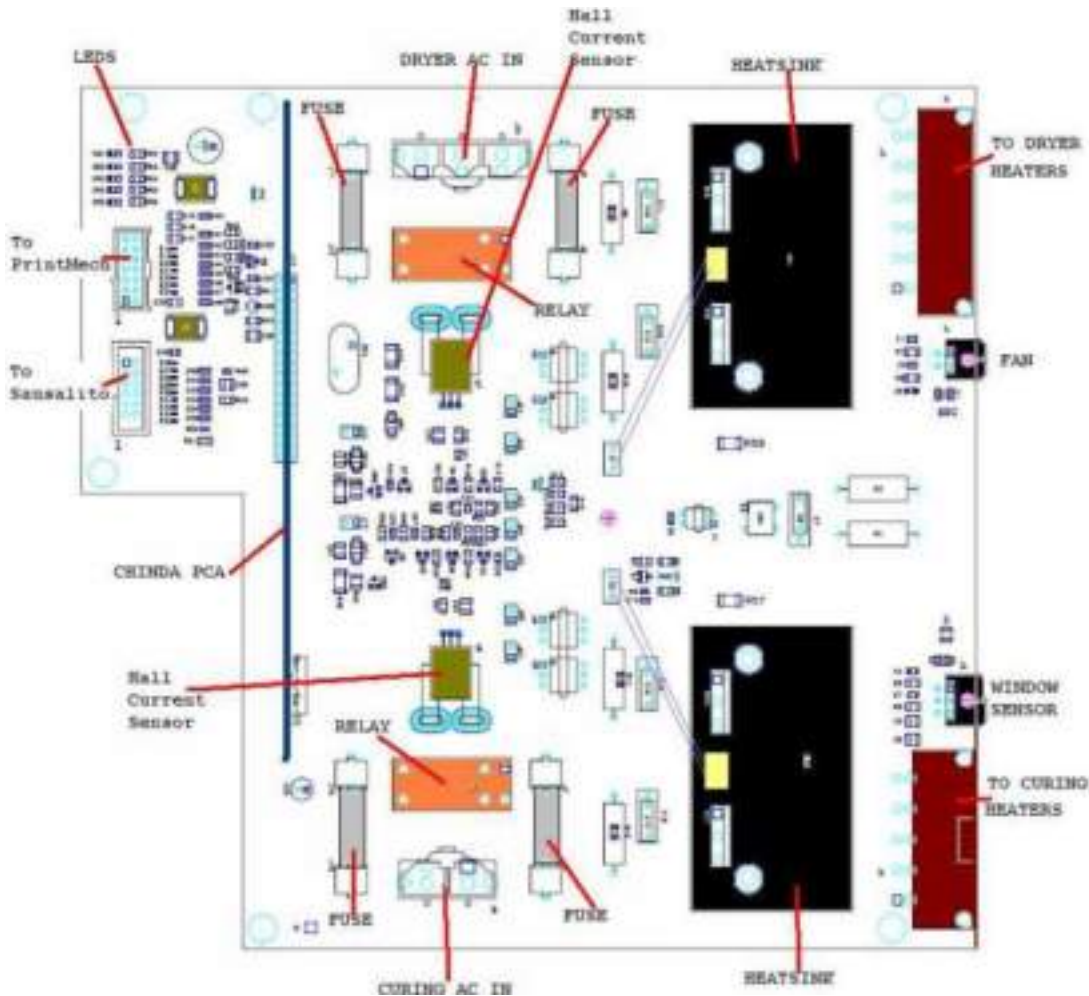

Related tests, utilities, and calibrations

- Heating and Curing service tests ⇒ Page 167.
- Heating and Curing Temperature ⇒ Page 195.

Service parts

- Front Covers ⇒ Page 264.
- Dyer and Curing Modules ⇒ Page 280.

Removal and installation

- Heating Control Assembly ⇒ Page 465.
- Heating Control Assembly Fan (42 inch) ⇒ Page 473.
- Dryer (IR) Heater Sensor ⇒ Page 496.
- Dryer Heater Assembly ⇒ Page 498.
- Curing Temperature Sensor ⇒ Page 503.
- Curing Fans ⇒ Page 503.
- Curing Heaters ⇒ Page 515.
- Curing Module ⇒ Page 525.

Front Panel

Description

Direct printer interactions are made through the Front Panel. The Front Panel is a small screen display and array of button controls located on the right side of the printer. The Front Panel is frequently used by Service Engineers. In general most things requiring direct mechanical interaction with the printer, such as tests or calibrations, are performed using the Front Panel. The Front Panel communicates with the Formatter via the Main Interconnect Board.

Components

The front panel is connected to the interconnect PCA and then to the formatter.

Functionality

Front Panel Key functionality

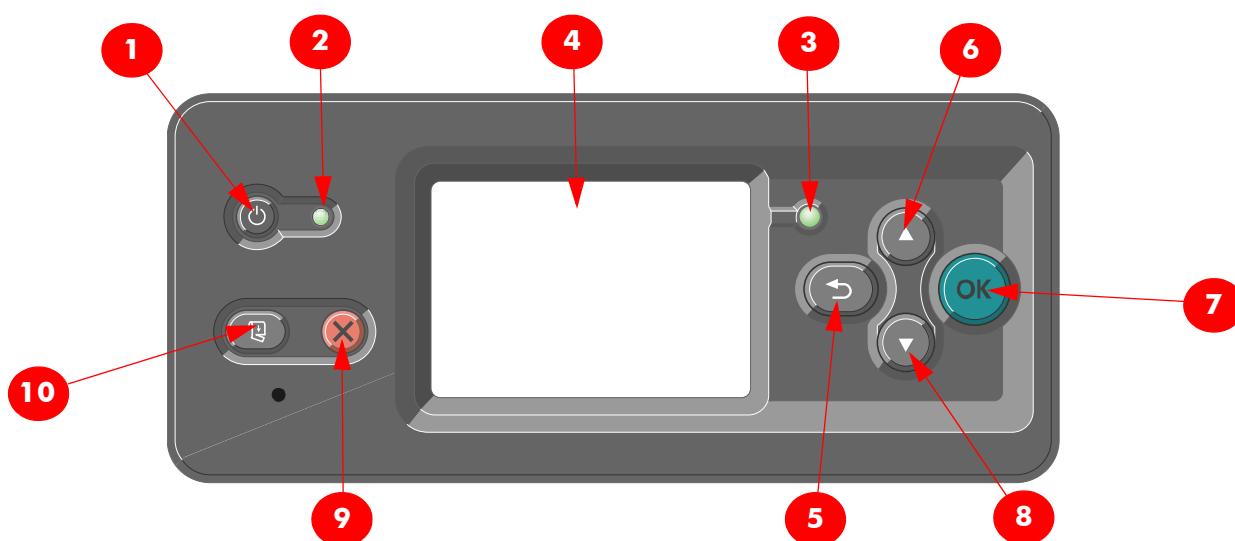

1. **Power key** - To turn the printer off.
2. **Power light** - Indicates the printer's power status. If the light is off, the printer is off. If it is solid green, the printer is on. If it is flashing green, the printer is in transition between on and off.
3. **Status light** - Indicates the printer's operational status. If the light is off, the printer is not ready. If it is solid green, the printer is ready and idle. If it is flashing green, the printer is busy: receiving data, processing or printing. If it is flashing amber, your intervention is required. If it is solid amber, a serious error has occurred.
4. **Front-panel display** - Displays error, warnings and information on using your printer.
5. **Back key** - To go to the previous step in a procedure or interaction. To go to the upper level, or leave the option in the menu, or when given an option.
6. **Up key** - To go up in a menu or option, or to increase a value.
7. **OK key** - To confirm an action while in a procedure or interaction. To enter in a submenu in the menu. To select a value when given an option.
8. **Down key** - To go down in a menu or option, or to decrease a value.
9. **Cancel key** - To cancel a procedure or interaction.
10. **Move substrate key** - To move the loaded substrate forwards or backwards, or rewind the roll.

Related tests, utilities, and calibrations

- Front Panel Service Test ⇒ Page 121

Service parts

- Front Panel ⇒ Page 270.

Removal and installation

- Front Panel ⇒ Page 353.

Front Panel Electronics Diagram

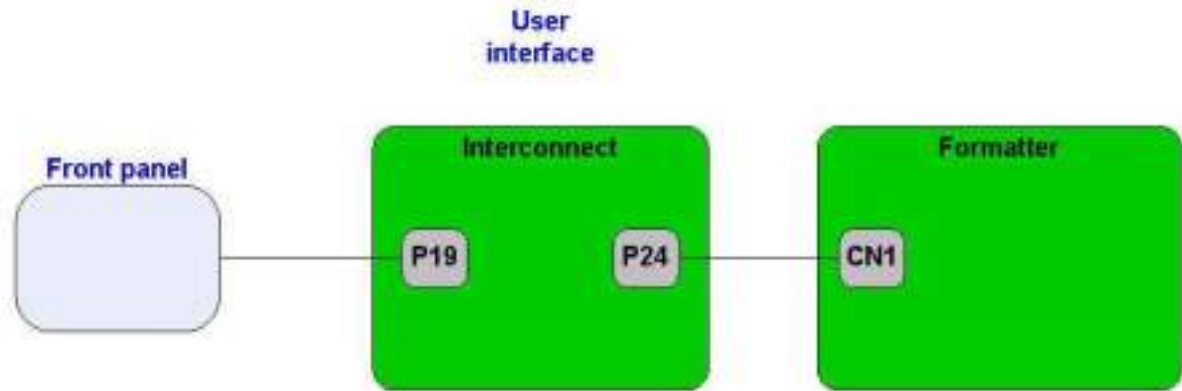

NOTE: The front panel is connected to the Formatter Board through a USB BUS and 5V standby & reset line. The standby and reset line is what enables you to start the Main Power Supply from the ON/OFF button of the front panel.

2 Troubleshooting

- Troubleshooting the printer 36
 - Printer Education and Training 36
 - Firmware upgrade 36
- Troubleshooting system error codes 36
- Performing a service test on a failed assembly 36
- Performing the necessary service calibrations 37
- Solving print quality problems 37
- The printer does not power on 37
- The printer continuously rejects printheads 37
- Cover sensors are not working 38
- The line sensor has problems detecting media 38
- Troubleshooting Media Jams/Printhead Crashes 38
- Troubleshooting shutdowns 39
- Vacuum suction much lower at high altitudes 40
- Banding due to ink cartridge replacement while printing 40
- Troubleshooting a failure with the take-up reel (TUR) 41
- Using the buzzer at power-up for troubleshooting problems 43
- Using the Power-up Sequence to Troubleshoot 44
- Troubleshooting OMAS problem 46
- Using the Power Switch LEDs to Troubleshoot 48
- Using the PCA LEDs to Troubleshoot 48
- Where to check the power fuses 53
- Checking the resistance values 54
- How to troubleshoot the 79:04 System Error 65

Troubleshooting the printer

Refer to Section 6 for troubleshooting Image Quality issues.

Printer Education and Training

Before any attempt is made to troubleshoot the printer, it is critical that you have the relevant training on the HP Designjet L25500 Printer series. If you are not trained on this printer, please contact HP Education or HP Training to enquire about becoming 'HP Service Qualified' for this printer.

Firmware upgrade

The first step to take when trying to clear an error with the printer is to check that the firmware installed in the printer is the latest available. Firmware updates often include fixes for some of the problems that are found in the following pages, simply updating the firmware can often resolve the problem. The latest firmware can be downloaded from the following url: <http://www.hp.com/go/designjet/downloads>

If the error with the printer does not allow you to upgrade the firmware using the normal process, try upgrading the firmware using the emergency .plt file procedure ⇒ page 179

Troubleshooting system error codes

Chapter 2, System Error Codes contains a list of system error codes and their respective descriptions and recommended corrective actions. Only try one recommended action at a time and check if the error code has disappeared.

If you have an error code which is not documented in this Service Manual or you have an error which you cannot resolve, then report the error to the HP Response Center or the nearest HP Support Office. When reporting the error, have the following information ready:

- Model and Serial Number of the printer.
- Which firmware revision the printer is using (See note below). Check firmware in Utilities / Statistics / Code rev.
- The complete error number.



NOTE: When reporting the System Error Code, make sure that you supply the full Error Code and the firmware version. Without this information, HP Support Personnel cannot help you.

- The Service Configuration Print.
- The Current configuration sheet.
- Which software application the customer is using (name, version, etc.).

Performing a service test on a failed assembly

If possible, always perform a Service Test on the component/assembly that you are about to replace, just to make sure that is the component/assembly that has failed.



NOTE: If the test on that component/assembly passes, you should NOT replace it.

For information on the Service Tests and how to use them see Chapter 4, Service Tests, Utilities & Calibrations ⇒ See page 117.

Performing the necessary service calibrations

Is the printer calibrated correctly after replacing a component? For information on the Service Calibrations and how to use them refer to Chapter 4, Service Tests, Utilities & Calibrations ⇒ See page 117.



NOTE: Remember that certain Calibrations are required even if an Assembly has been disassembled to gain access to another Assembly or Component.

Solving print quality problems

Whenever a Print Quality problem appears, it is advisable to print all test plots to help diagnose the problem. The test plots will help you differentiate between possible printhead errors and other problems such as incorrect front-panel selection, RIP configuration or mechanical problems. For information on solving Print Quality problems see Chapter 5, Print Quality ⇒ See page 227.

The printer does not power on

To resolve printer power up problems, do the following:

1. Check that the power cord is connected correctly to the Printer and to the Power Socket.
2. Check that the Power Switch on the BACK of the Printer is in the ON position.
3. Check to see if any of the LEDs on the Power Switch are On. If any of the LEDs are On, then refer to See page 48 for more information.
4. Check the Circuit Breaker (Ground fault Interrupter) of the customer's premises has not blown.
5. Check that the Front-Panel Cable is correctly connected to the Electronics Module. Also make sure that the Front-Panel cable is not damaged.
6. Replace the CPU Fan ⇒ See page 446
7. Replace the Power Supply Unit ⇒ See page 456.

The printer continuously rejects printheads

To resolve printhead rejection problems, do the following:

1. Clean the flex contacts on the Printhead and in the Carriage Assembly using the Carriage Interconnect Wiper (Refer to Chapter 3) and try again.
2. Swap the failed Printhead with a Printhead that is known to be working, and check if the error follows the printhead:
 - If the error follows the Printhead try to recover the Printhead by cleaning the contact again, if that failed, replace the Printhead.
 - If the error does not follow the Printhead, clean again the Carriage Interconnect and check for damage, check the Carriage Interconnect if appropriate.
3. If ALL the Printheads are rejected (the status message on the Front Panel does NOT show "OK" for ALL the Printheads) then perform the Electronic Systems Test ⇒ See page 123.

Cover sensors are not working

To resolve cover sensor problems, do the following:

1. Perform the Sensors Test ⇒ See page 173.
2. Check if the cable for the faulty sensor is not damaged and is connected correctly.
3. Replace the faulty Sensor.

The line sensor has problems detecting media

To resolve line sensor media detection problems, do the following:

1. Check the type of media that is being used since the Line sensor may have problems detecting transparent media or some types of Non-HP media. Try loading white HP media in to the Printer and check if the Line sensor detects it.
2. Excessive ink deposits on the Platen surface can fool the sensor by reflecting the light. Clean the Center Platen.
3. The Line Sensor is not calibrated correctly. Perform the Line Sensor Calibration ⇒ See page 162.
4. The Line Sensor is damaged or faulty. Replace the Line Sensor ⇒ See page 486.

The Cutter does not function

Under certain circumstances the cutter will not cut the media. This is mainly when the take-up reel is enabled, but there are other circumstances when the cutter will not cut.

- If the settings for the RIP have disabled the Cutter, but the customer has set the Front Panel settings to cut, the customer could expect it to cut at the end of the job.
- If the customer presses the 'Form Feed and Cut' option, but the Cutter is disabled on the Front Panel.
- If the substrate being printed on cannot be physically cut because it is too thick.

The customer can enable and disable the cutter from the Front Panel (but remember this will be overridden by the RIP). To enable the cutter from the Front Panel; select the substrate icon, then Substrate handling options>Enable /Disable.

Troubleshooting Media Jams/Printhead Crashes

The failure modes "media jam" and "head crash" are grouped together because in many cases a media jam causes the media to lift up into the Carriage path and cause a Printhead crash, thus causing many media jam failures to be detected as head crashes.

1. Did the media jam occur when loading media?



NOTE: When clearing a media jam, sometimes media is stuck in the paper path. To clear this, you must lift the Media Lever and insert thicker media into the paper path to push out the media that is still stuck there.

- If the client has had media jams, it is common for pieces of media to get stuck in the media path. Clear the media path.

- In order to minimize the problem, check the top edge of the substrate for damage or excessive curling. If the substrate is a self-adhesive type of substrate, check that the backing paper (the liner) has not become detached.
 - Check that the substrate has been correctly adjusted following the 'Add new Substrate procedure' in the User's Guide.
2. Check that the Vacuum Fan works correctly.

Troubleshooting shutdowns

Paper Path

To resolve paper path problems, do the following:

1. Open the Window and check for any visible obstacles restricting the movement of the Drive Roller. Make sure that the mylar is not damaged. If there is a wrinkled mass of media inside the paper path, lift the Pinch wheels (using the Media Load Handles) and clear the obstruction.
2. If this shutdown happens at the end of a Roll of Media, it could be because the media is stuck firmly to the Roll. Lift the Pinch wheels (using the Media Load Handles) and pull the media clear.
3. Replace media spindle if broken.
4. Replace the Media-Axis Motor ⇒ See page 422.

Printhead path

When a shutdown occurs in the Printhead path, the message "Switch Power Off / Check Printhead Path (*)" will be displayed. The (*) will be a number, which will give an indication on where the failure occurred:

PWM shutdown

To resolve a PWM shutdown, do the following:

1. Clean Slider Rods and Apply Oil along the complete axis of the Slider Rods. After applying the Oil, perform the Scan-Axis Test ⇒ See page 157 and check that the values are within the given limits.
2. Replace the Scan-Axis Motor ⇒ See page 419.

Velocity shutdown

To resolve a velocity shutdown, do the following:

1. Open the Window and check for any visible obstacles restricting the movement of the Carriage Assembly. Try and move the Carriage Assembly manually, checking for smooth and free movement.

Energy shutdown

To resolve an energy shutdown, do the following:

1. Clean Slider Rods and Apply Oil along the complete axis of the Slide Rods. After applying the Oil, perform the Scan-Axis Test ⇒ See page 157 and check that the values are within the given limits.
2. Replace the Scan-Axis Motor ⇒ See page 419.

Vacuum suction much lower at high altitudes

At altitudes above 3,000 meters, the vacuum force holding down the media will be lower, therefore the media will not be held in place sufficiently causing:

- Ink Smearing on the Media.
- Printhead crashes against the Media.
- Roll Media loading problems (low probability).

The level of Vacuum applied to the substrate can be adjusted from the RIP.

Banding due to ink cartridge replacement while printing

A user has removed the Ink Cartridge while the printer was printing, which has caused the printer to stop. If the user does not replace the Ink Cartridge immediately, when the printer starts to print again, a band will appear in the position where the printing restarted. This is because the wet ink interacts with the dried ink on the media causing the band to appear. To solve the problem, try the following:

- Do NOT remove the Ink Cartridge while the Printer is Printing. Only replace/remove Ink Cartridges in between Prints.
- If the Ink Cartridge was replaced due to the "Empty" status on the Front Panel, then advise the customer to replace the Ink Cartridge when the "Very Low" status is showing on the Front Panel.

Troubleshooting a failure with the take-up reel (TUR)

Use this section to troubleshoot failures with the take-up reel.

Take-up reel LED status information

LED status	Issue	Print job interrupted	Possible cause	Print job interrupted?
Blinking quickly	Take-up reel not winding	Yes	Sensor beam blocked for more than 3 seconds	Ensure the take-up reel sensors are not blocked by a strip of paper, the collection bin or other objects. Also ensure the take-up reel power switch is in the On position.
Blinking slowly	Take-up reel not winding	No	The sensor cables are loose or unplugged	Ensure the sensor cables are correctly connected.
Solid red	Take-up reel not winding	No	There is too much resistance on the take-up reel motor	ENSURE THAT THE TUR Spindle Lever is CLOSED! Ensure the paper is not winding too tightly. A loop-shaping core should be inserted and hanging down.
Solid green	Take-up reel not winding	No	The take-up reel power switch is in the Off position	Ensure the take-up reel power switch is in the On position.
Solid green	Take-up reel winding in the wrong direction, and not stopping the job.	No	The take-up reel wind direction switch is in the wrong winding position. after 3 seconds, the printer will recognize the problem and interrupt the print job. In this case, see the first error listed in this table.	Flip the take-up reel wind-direction switch to the correct position.



NOTE: If the LED is flashing but there is no message on the front panel, restart the printer.

Checking the take-up reel is correctly installed

Many system error codes are displayed as a result of the take-up reel not being installed correctly or because parts have moved or become dislodged from their correct positions. This troubleshooting procedure checks the mechanical installation of the take-up reel.

1. Check that the take-up reel sensor unit is correctly installed on the right foot.

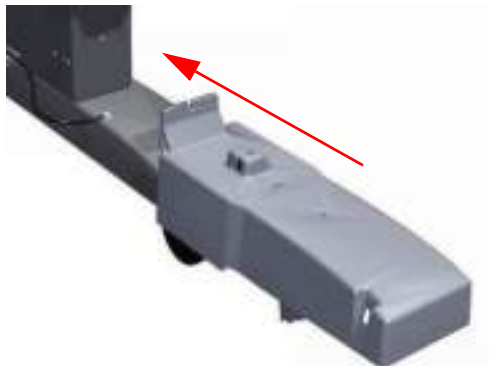

2. To correctly install the foot, the wheel has to be positioned as shown.



3. Check the cables linking the sensors to the take-up reel Motor Assembly are correctly connected.



4. Check that the take-up reel motor assembly is correctly connected to the rear of the printer.

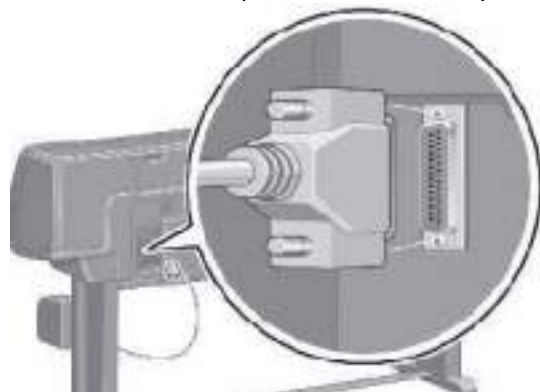

How the take-up reel works

How to enable the take-up reel:

The take-up reel must be enabled and operated from the front panel. When the take-up reel is enabled, the "Take-up reel enabled" message appears on the Substrate tab on the front panel. Select the substrate icon and then select Take-up reel >Enable take-up reel.

How it works?

When the bottom of the 'loop' is lower enough and it cuts the signal between the 2 sensors, the take-up reel starts to move the motor until the signal between the 2 sensors is passing through again.

If after the few seconds of turning the take-up reel, the signal between two sensors is still cut, the take-up reel displays a 'take-up reel paper jam' error:

- In all case, the LED of the take-up reel is blinking quickly
- and if the take-up reel is enabled on the front panel, a 'Take-up reel' paper jam will be displayed.

Cutter Behavior

The cutter activity will depend on the status of the take-up reel and the settings selected in the (1st) the RIP and (2nd) the Front Panel.

- If the take-up reel is enabled, the Cutter will be turned off. This will override the settings both in the RIP and the Front Panel.
- If the take-up reel is not enabled, Cutter settings from the RIP will take precedence over the Front Panel settings. If there are no cutters settings in the RIP, the Front Panel settings are observed.

Using the buzzer at power-up for troubleshooting problems

When the Printer is powered up, it doesn't make a "Beeping Sound" until it is completely powered-up and ready to use. If there is a beep during the power-up sequence, this may signify that there is a problem within the Electronics Module. The following table will help you to use the "Beeping Sound" to diagnose certain problem:

Number of Beeps	Problem Description	Corrective Action
1	Processor absent	<ul style="list-style-type: none"> • Check that the cable between the Power Supply Unit and the Main PCA is not damaged and is correctly connected • Replace the Main PCA ⇒ See page 450.
2	Faulty Main PCA or PSU	<ul style="list-style-type: none"> • Check that the cable between the Power Supply Unit and the Main PCA is not damaged and is correctly connected • Replace the Main PCA ⇒ See page 450. • Replace the PSU ⇒ See page 456.
3	Faulty Memory Module	<ul style="list-style-type: none"> • Check that the Memory Module is installed correctly. • Try installing the Memory Module in the other Memory slot and check if the problem remains. • If the problem reappears, replace the Memory Module ⇒ See page 448. • If the problem does NOT remain, then the original slot could be faulty. In this case, replace the Main PCA ⇒ See page 450.

Number of Beeps	Problem Description	Corrective Action
4	Front Panel	<ul style="list-style-type: none"> • Check that the Front Panel cable is not damaged and is correctly connected between the Front Panel and the Interconnect PCA. • Perform the Front Panel service test ⇒ See page 121 • Replace the Front Panel ⇒ See page 353
5	Faulty PCI Card	<ul style="list-style-type: none"> • Replace the Main PCA ⇒ See page 450
6	BIOS Damaged	<ul style="list-style-type: none"> • Replace the Main PCA ⇒ See page 450
7	Motherboard damaged	<ul style="list-style-type: none"> • Replace the Main PCA ⇒ See page 450
8	Hard Disk Drive damaged or missing	<ul style="list-style-type: none"> • Remove the Main PCA Cover and (with the Printer switched On) check that the HDD is spinning (you should feel it spinning when you touch it or at least hear it spinning). If the HDD is not spinning, then it could be damaged. In this case, replace the HDD ⇒ See page 452. • Make sure that ALL cables connected to the HDD are not damaged and are connected correctly. • Replace the HDD ⇒ See page 452 • Replace the Main PCA ⇒ See page 450

If after performing all of the above troubleshooting procedures the system error is still displayed:

- Check that the cables between the Interconnect PCA and the Main PCA are not damaged and are correctly connected.
- Check that the cable between the Power Supply Unit and the Main PCA is not damaged and is correctly connected.
- Replace the Interconnect PCA.
- Replace the Sausalito PCA.

Using the Power-up Sequence to Troubleshoot

When the Printer is powered up, it performs the Boot-UP sequence which initializes the major components of the Printer. If for some reason the Boot-Up sequence fails because a components has failed to initialize, the following explanations will help you to locate the failing component.

Step	Initialization Process
BULNEX KERNEL BOOT	
30	rc.sysinit rerun through initlog.
29	<ul style="list-style-type: none"> • Environmental variables PATH, NETWORKING, HOSTNAME set. • Source /etc/init.d functions.
28	<ul style="list-style-type: none"> • Fix console loglevel. • Mount /proc. • Dismount the initrd, if necessary. • Configure kernel parameters.
27	Set the system clock.
26	Load keymap.
25	Load system font.
24	Start up swapping.

Step	Initialization Process
23	<ul style="list-style-type: none"> Set the hostname. Initialize USB controller and HID devices
22	<ul style="list-style-type: none"> Set variables for options to be later used for filesystem check Turn Off DMA on CD-ROMs Turn On Hard Disk optimization
21	Perform file system check on root volume.
20	Update quotas if fsck was run on root
19	Setup pnp
18	<ul style="list-style-type: none"> Remount the root filesystem read-write. LVM initialization. Clear mtab. Enter root, /proc and (potentially /proc/bus/usb and devfs into mtab. Remove /lib/modules/preferred and /lib/modules/default. Tweak isapnp settings if needed. Load sound modules if the need persistent DMA buffers.
17	<ul style="list-style-type: none"> Load modules from /etc/rc.modules. File system check. Add raid devices.
16	<ul style="list-style-type: none"> Setup Logical Volume Management. Check filesystems on all volumes found on /etc/fstab.
15	Mount local filesystems.
14	Check remaining quotas other than root.
13	Enable local filesystem quotas.
12	<ul style="list-style-type: none"> Configure machine if necessary (if the respective configure files exist). Reread in network configuration data.
11	<ul style="list-style-type: none"> Clean out /etc, (w/u)tmpx files, /var. Reset pam_console permissions. Cleanup utmp/wtmp. Delete X locks. Delete VNC and X locks. Delete Postgres sockets. Turn On swap in case we swap to files.
10	<ul style="list-style-type: none"> Initialize the Serial Ports. If a SCSI tape has been detected, load the st module unconditionally. Load usb storage to match most other things. If ide-scsi is required, load it. Generate a header that defines the boot kernel.
9	<ul style="list-style-type: none"> Dump the syslog ring in /var/log/dmesg. Keep kernel symbols in /var/log/ksyms. Create the crash indicator flag to warn on crashes, offer fsck with timeout.
8	Export this variable BOOT_PART and INSTALL_PART.
PRINT APPLICATION STARTING POINT	
7	IO kernel mode initialization (basically).
6	Printer Application Infrastructure startup.
5	Printer IO startup.
4	Front Panel application startup (but wait for engine launching, i.e. Front Panel is not cleared yet).

Step	Initialization Process
3	Engine startup, start EE and Mechanical initialization.
2	HPGL/PS parsers startup.
1	All subsystems launched. Wait for Front Panel application to clear the Front Panel and start signaling the initialization sequence.

Corrective Actions for Power-Up Problems

To resolve power-up problems, use the following corrective actions:

1. If the Printer's Power-Up process stops when the front panel is displaying the number **17**, this indicates that there is a problem with the file system on the Printer's Hard Disk Drive, so the Printer is checking the whole file system and making any necessary corrections. This problem can arise when there has been a power cut while the Printer was switched On, or if there is a physical problem with the Hard Disk Drive.

Checking the whole file system normally takes about half an hour (but could take much longer). There is nothing that can be done to speed up the file checking process. If you turn Off the Printer during the checking process, the file system check will restart whenever you turn it On again.

If you experience this problem repeatedly when there has been no power cut, then this could mean that the Hard Disk Drive is faulty. In this case, replace the Hard Disk Drive ⇒ See page 452.

2. If the printer's start-up process stops when the front panel is displaying any number between **1** to **30**, then try the following:
 - Switch the Power OFF from the back of the Printer and disconnect the Power cord. Reconnect the power cord and power On the Printer.
 - If the Printer continues to stop during the power-up process, replace the Hard Disk Drive ⇒ See page 452.

Troubleshooting OMAS problem

A problem with the OMAS board may cause the printer to display a **50.2:10 service error**, this can be fixed by checking the following connections.

1. Check the CAN Cable is correctly connected.



- 2. Check the other end of the CAN cable is also correctly connected



- 3. Check the LEDs under the OMAS board.

This LED only comes on for the first 20 seconds after the printer is turned On. When the firmware has successfully loaded into the memory the LED will switch OFF.

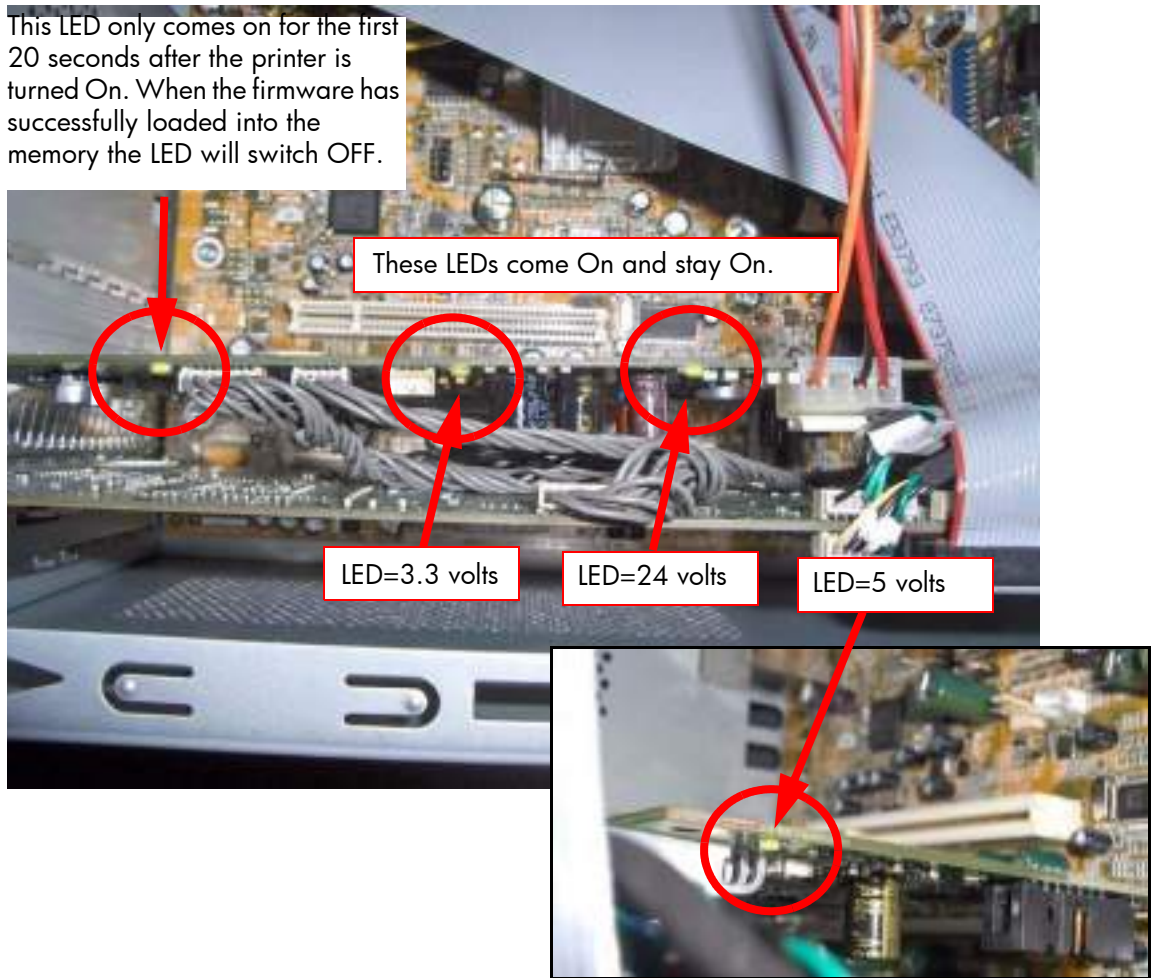

Using the Power Switch LEDs to Troubleshoot

In certain circumstances, the LEDs located on top of the power switch (located at the rear of the Printer) can help to troubleshoot the Printer. The LEDs can either be ON or Off and using different combinations can indicate different problems:



Amber is on the Left
Blue is in the center
Green is on the Right

Make sure you look directly at the LEDs and not at an angle.

1. When only the **Amber LED** is On:
 - The Printer has been switched Off from the Front Panel (after having pressed the On/Off button).
 - The Power Supply Unit only delivers a 5 V “Standby”; power that is needed to restart the Printer after the Front Panel On/Off button is pressed (the Formatter/Main PCA will initiate the Printer to start).
2. When the **Blue LED** is On: Deliver standard “ATX” power for the Electronics Module PCAs (+12V, +5V, -5V, -12V, etc...). All the functions of the Electronics Module are fully operational (EWS, etc...).
3. When the **Green LED** is On: Deliver “analog” 24V and 42V to enable printing.

The Printer monitors and reports different signals: PSU fan issues, 24V and 42V delivery failures (specific System Error reported pointing to PSU failure).

PSU Blue LED Status	PSU Green LED Status	Left LED (on Front Panel) Status	Printer Status
ON	OFF	Red (Front Panel Black)	Standby (with Embedded Web Server up and running)
ON	OFF	Green (flashing)	Initializing
ON	ON	Green	Ready (but not printing)
ON	ON	Green (flashing)	Printing or preparing to print
OFF	ON	Any	Not possible
ON	ON	Red (Front Panel Black)	Not possible

Using the PCA LEDs to Troubleshoot

In certain circumstances, the LEDs located on the Interconnect PCA and PrintMech PCA can help to troubleshoot the Printer. The LEDs can either be ON or Off and using different combinations can indicate different problems.

Interconnect PCA

To view the LEDs on the Interconnect PCA first remove the cover secured with six T-10 screws.



5V - Comes from the PSU after the fuse on Interconnect PCA. Used to power On Front Panel and some Interconnect Electronics. Should be ON at the same time as Blue Power Switch LED.

5Vsb - Comes from the PSU after the fuse on Interconnect PCA. Used to power On the Printer from the Front Panel. Should be ON at the same time as Blue or Amber Power Switch LED.

24V - Comes from the PSU after a fuse on the PrintMech PCA.

VPOWER2 - Comes from the PSU (42V) after a fuse on the Interconnect PCA. Used to power the Carriage PCA. Should be ON at the same time as Green Power Switch LED.

PrintMech PCA

The following illustration shows the locations of the LEDs on the PrintMech PCA.

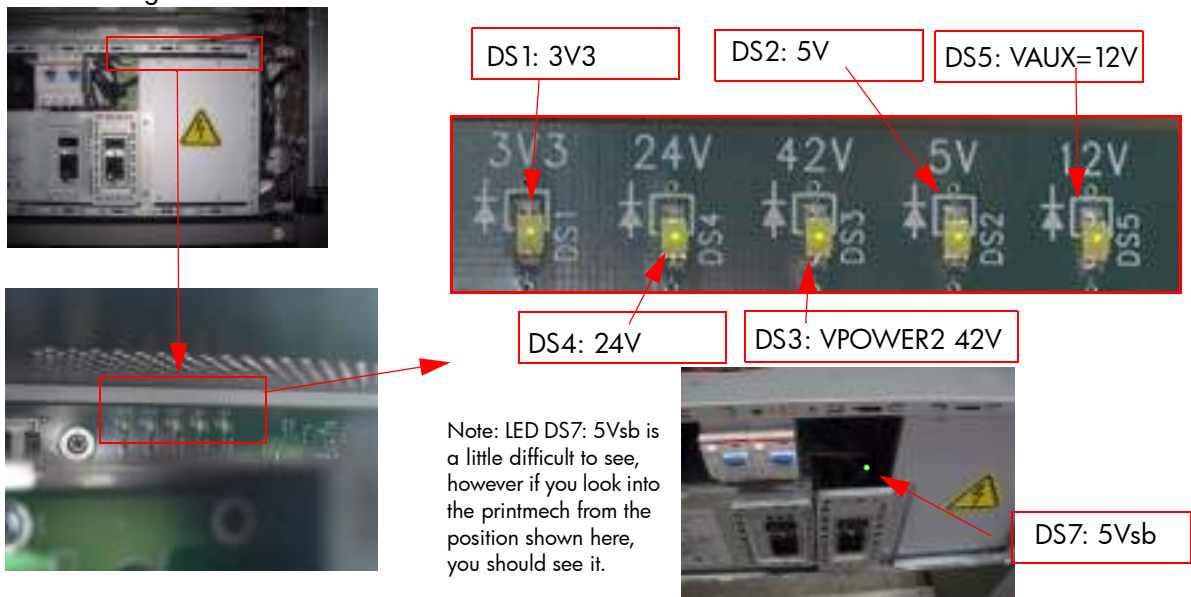

DS7: 5Vsb - Comes from the PSU after the fuse on PrintMech PCA.

DS1: 3V3 - Comes from the Power Supply Unit.

DS2: 5V - Comes from the Power Supply Unit.

DS3VPOWER2 - Comes from the PSU (42V) after a fuse on the PrintMech PCA.

DS5: VAUX - Comes from the PSU (12V) after a fuse on the PrintMech.

DS7: 5Vsb - Comes from the Power Supply Unit

Identifying faults from LED status

Use the following procedure to identify faults from the status of the LEDs.

1. If the Printer cannot be turned ON:

Signal	LED on Interconnect PCA	LED on PrintMech PCA	Power Switch LED	Corrective Action
5Vsb	OFF	ON	Amber	<ul style="list-style-type: none"> • Check the connection between the PSU and the Interconnect PCA. • If connection OK, replace the Interconnect PCA ⇒ See page 435.
5Vsb	ON	OFF	Amber	<ul style="list-style-type: none"> • Check the connection between the PSU and the PrintMech PCA. • Make sure that ALL cables between the PSU and PrintMech are not damaged and are connected correctly.
5Vsb	OFF	OFF	Amber or no LED	<ul style="list-style-type: none"> • Check the connection between the PSU and the PrintMech PCA and Interconnect PCA. • If connection OK, check that power reaches the PSU (check the power outlet). • If power reaches PSU, replace the PSU ⇒ See page 456.

2. If the Printer starts (after having pressed the ON button on the Front Panel) but the front Panel remains black:

Signal	LED on Interconnect PCA	LED on PrintMech PCA	Power Switch LED	Corrective Action
5V	OFF	ON	Blue	<ul style="list-style-type: none"> • Check the connection between the PSU and the Interconnect PCA. • If connection OK, replace the Interconnect PCA ⇒ See page 435.
5V	ON	ON	Blue	<ul style="list-style-type: none"> • Check the connection between the Front Panel and the Interconnect PCA. • If connection OK, replace the Interconnect PCA ⇒ See page 464 and the Front Panel ⇒ See page 353.

3. The Printer is up and running, or may have a System Error at the end of the power-up sequence.

Signal	LED on Interconnect PCA	LED on PrintMech PCA	Power Switch LED	Corrective Action
5V	OFF	ON	Blue	<ul style="list-style-type: none"> • Check the connection between the PSU and the Interconnect PCA. • If connection OK, replace the Interconnect PCA ⇒ See page 435.

Signal	LED on Interconnect PCA	LED on PrintMech PCA	Power Switch LED	Corrective Action
24V	ON	ON	Blue and Green	<ul style="list-style-type: none"> Check the System Error that is produced and run the corresponding Diagnostic Test (either Scan-Axis or Media-Axis Test).
24V	OFF	OFF	Blue and Green	<ul style="list-style-type: none"> Check the connection between the PSU and the PrintMech PCA and Interconnect PCA. If connection OK, run the Electronics Module Test to further diagnose the problem.
24V	OFF	ON	Blue and Green	<ul style="list-style-type: none"> Check the connection between the PSU and the Interconnect PCA. If connection OK, run the Electronics Module Test to further diagnose the problem.
24V	ON	OFF	Blue and Green	<ul style="list-style-type: none"> Check the connection between the PSU and the PrintMech PCA. If connection OK, run the Electronics Module Test to further diagnose the problem.

4. If the Power Switch LED is Green and the 3V3 LED is ON, 5V LED is ON, VAUX LED is ON and the VPOWER2 LED is OFF, then try the following:
- Check the connection between the PSU and the PrintMech PCA.
 - Run the Electronics Module Test to further diagnose the problem ⇒ page 123.
 - Replace the PrintMech PCA ⇒ See page 464.

Heaters Control Assembly PCA (Petisa)

There are four LEDs that can help when troubleshooting basic issues with the Heater Control Assembly:

- DS1 ○ +24V
- DS2 ○ Relays Active
- DS3 ○ Relays Enabled
- DS4 ○ Halt
- DS5 ○ +5V

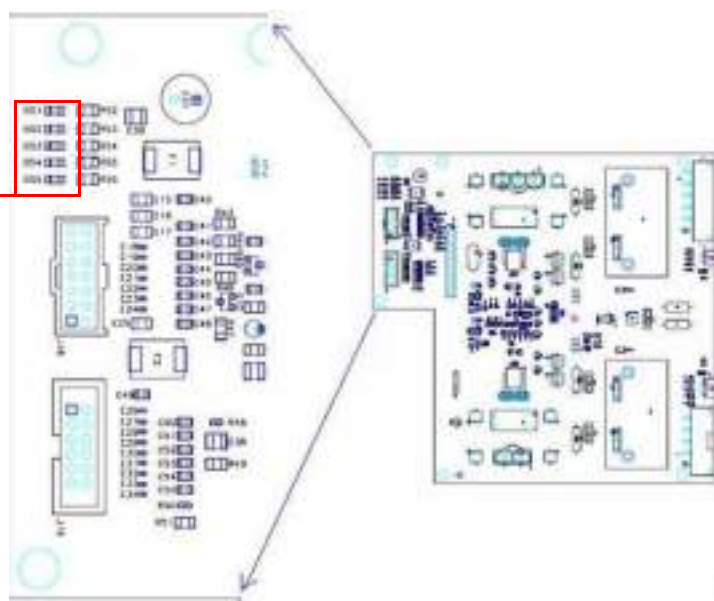

LEDs	Status	Troubleshooting
<ul style="list-style-type: none"> ● +24v Present ● Relays Active ● Relays Enabled ● Halt ● +5v present 	<p>Normal operation. This is the normal functioning status of the Heaters Control Assembly PCA.</p>	<ul style="list-style-type: none"> • This is the normal functioning status of the Heaters Control Assembly PCA.
<ul style="list-style-type: none"> ● +24v Present ● Relays Active ● Relays Enabled ● Halt ● +5v present 	<p>No Power. The PCA is not receiving 24V nor +5V power from the PrintMech.</p>	<ul style="list-style-type: none"> • Check the printer connected to the power source. • Are the switches of the power inputs in the on position. • Have either of the RCCB/GFIs been tripped, if they have reset them. • Check the AC cables to the Heaters Control board. • Check the fuses have not blown. • Replace the Heaters Control Assembly ⇒ page 465.
<ul style="list-style-type: none"> ● +24v Present ● Relays Active ● Relays Enabled ● Halt ● +5v present 	<p>No 24v Power. The PCA is receiving +5 volts, but not 24 volts from the PrintMech.</p>	<ul style="list-style-type: none"> • Check the connection between the PSU and the PrintMech PCA and Heaters Control PCA. • Replace the Printmech ⇒ page 482. • Replace the Heaters Control Assembly ⇒ page 465.
<ul style="list-style-type: none"> ● +24v Present ● Relays Active ● Relays Enabled ● Halt ● +5v present 	<p>Halt status. This configuration of LEDs indicate that the printer is in the HALT condition. This is could be a normal part of the printer initialization, before 24v has been activated. However if it continues after the initialization, this would indicate a problem.</p>	<p>This is a normal status when resetting the Heaters Control Assembly and before applying the 24v.</p>
<ul style="list-style-type: none"> ● +24v Present ● Relays Active ● Relays Enabled ● Halt ● +5v present 	<p>Halt status with 24v present. This configuration of LEDs indicate that the printer is in the HALT condition. This could be a normal part of the printer initialization. However if it continues after the initialization, this would indicate a problem.</p>	<p>If this is the status after resetting the Heaters and there is no system error check the following:</p> <ul style="list-style-type: none"> • Check that the window is not open in error. • Check the cables to the Heaters Control assembly are correctly connected. Check the other connections to the other PCAs • Replace the Heaters Control Assembly ⇒ page 465.
<ul style="list-style-type: none"> ● +24v Present ● Relays Active ● Relays Enabled ● Halt ● +5v present 	<p>The relays are not activated</p>	<ul style="list-style-type: none"> • Check all the connections in the Heaters Control PCA (Chinda connection) • This status is normal if the Heaters Control assembly has been turned off from the Front Panel.
<ul style="list-style-type: none"> ● +24v Present ● Relays Active ● Relays Enabled ● Halt ● +5v present 	<p>Error Status. The relays have been enabled, but they are inactive.</p>	<ul style="list-style-type: none"> • Check if the window is open. • Replace the Heaters Control Assembly ⇒ page 465.

LEDs	Status	Troubleshooting
<ul style="list-style-type: none"> ● +24v Present ● Relays Active ● Relays Enabled ● Halt ● +5v present 	Error Status. The relays have been enabled during a HALT condition.	<ul style="list-style-type: none"> • Replace the Heaters Control Assembly ⇒ page 465.
<ul style="list-style-type: none"> ● +24v Present ● Relays Active ● Relays Enabled ● Halt ● +5v present 	Abnormal status. No 5 volts available. There is 24v present, but the 5volts from the PrintMech is not arriving	<ul style="list-style-type: none"> • Check the cables and connections between the PSU, the PrintMech, Sausalito and the Heaters Control PCA. • If connections OK, replace the Heaters Control Assembly ⇒ page 465.
<ul style="list-style-type: none"> ● +24v Present ● Relays Active ● Relays Enabled ● Halt ● +5v present <p>DANGER</p>	A HALT condition is present, but the relays are active (Warning). Although the HALT signal is active, the relays are enables and active. This could lead to a safety hazard.	<ul style="list-style-type: none"> • TURN OFF THE PRINTER • Replace the Heaters Control Assembly ⇒ page 465.

Where to check the power fuses

If you need to check if the power fuses are blown, remove the cover from the Power Control Module, two access two PCAs. Using a multimeter you can then check the fuses shown in the diagram below.

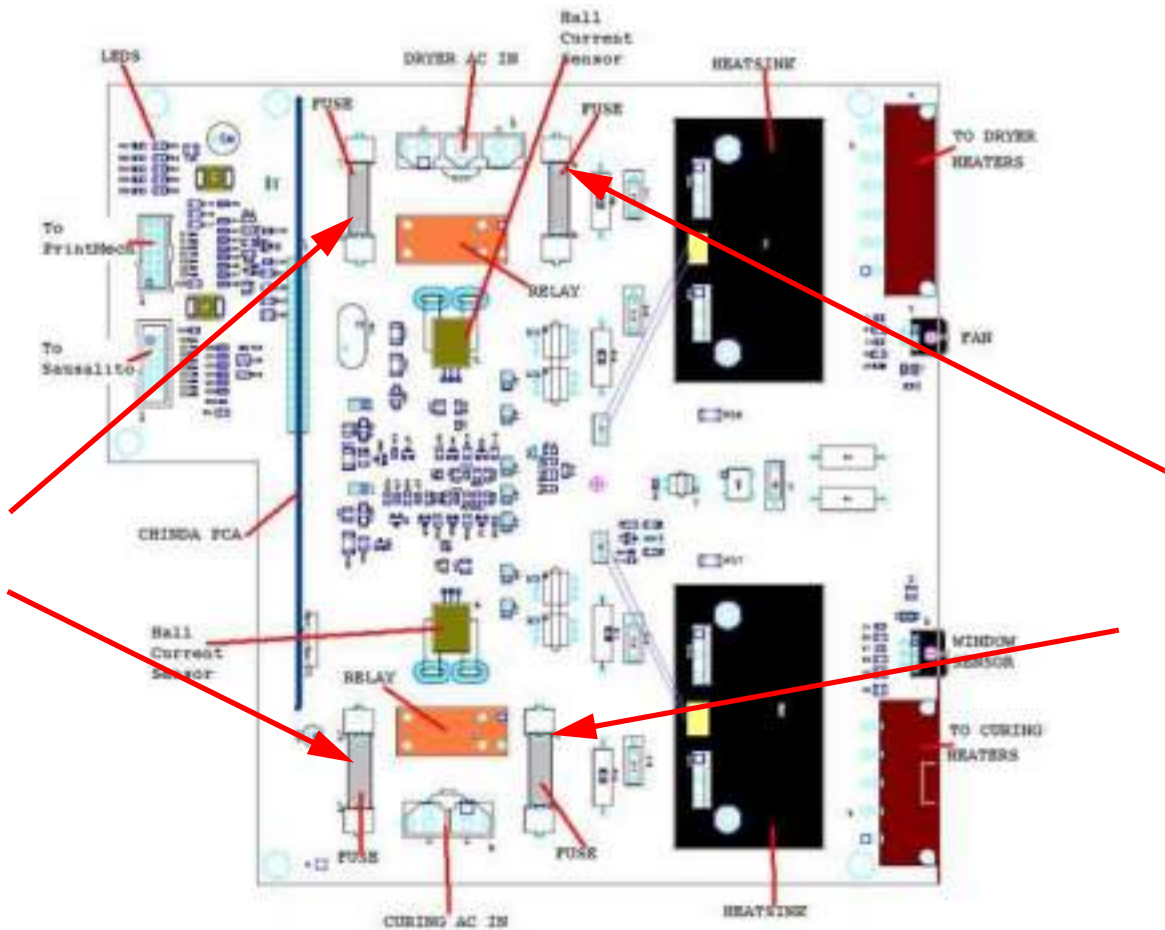

Checking the resistance values

Part of troubleshooting some of the system error codes related to the Dryer and Curing Assemblies involves checking the resistance values. In the tables shown below are the resistance values that would typically be seen when the resistors have **not been used for 1 hour**.



Resistance values as seen in P1 and P2 connectors on the Power Control PCA

	Type of resistor	Dryer resistance value (ohms)	Upper spec	Lower Spec
60"	Steady	27.0 +5%	28.4	25.7
	Burst	40.6 +5%	42.7	38.6
42"	Steady	31.1 +5%	32.7	29.6
	Burst	41.3 +5%	43.4	39.2
60"Japan	Steady	27.0 +5%	28.4	25.7
	Burst	29.3 +5%	30.7	27.8

	Type of resistor	Curing resistance value (ohms)	Upper spec	Lower Spec
60"	Steady	31.7 +5%	33.2	30.1
	Burst	47.5 +5%	49.9	45.1
42"	Steady	39.4 +5%	41.3	37.4
	Burst	52.2 +5%	54.8	49.6
60"Japan	Steady	31.4 +5%	33.0	29.8
	Burst	31.4 +5%	33.0	29.8

How to Interpret the Service Information Pages

The Service Information Pages contain the following information:

- Current Configuration
- Current Information.
- Usage Information.
- Event Logs.
- Calibration Status.
- Connectivity Configuration
- All Pages.

It is possible to print the Service Information Pages either through the Front Panel or through the Embedded Web Server:

- Front Panel: Setup menu ⇒ Internal Prints ⇒ Service Information Prints.
- Embedded Web Server: Support tab ⇒ Troubleshooting ⇒ Printer Information.

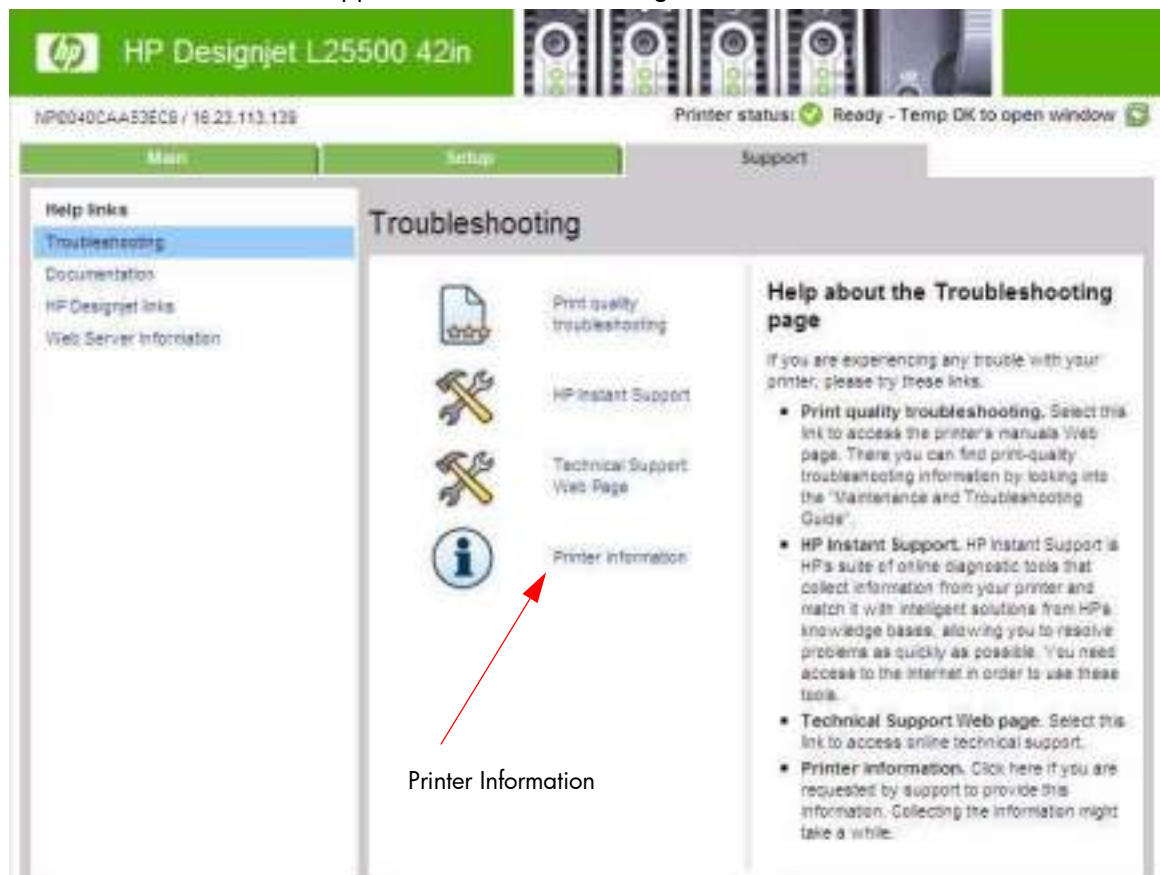

Even if the Printer cannot print, the Information Pages are still accessible through the Embedded Web Server.

Main Characteristics

- Only available in English (except the current information page).

- From the Front Panel, you can choose to print ALL pages or just select the specific pages that are needed. If ALL pages are printed, nesting is turned ON automatically (and turned OFF once all the pages have been printed).
- Each page can be printed from the Web browser when using the Embedded Web Server.
- Each page can be sent by e-mail from the Web Browser when using the Embedded Web Server (File ⇒ Send ⇒ Page by E-mail).
- You can see the same information through the Front Panel or the Embedded Web Server.

Current Configuration

This page contains full details of the current configuration of the Printer.



Current Information (1 of 2)

The first section, is generic information and is available in every tab, it displays information such as the current level of firmware installed, the serial number of the printer etc.

This page is in two parts: The first part displays information on the following:

- Current Printer Configuration.
- Substrate Loaded Information.
- Current Printhead Kit Information.

Current configuration	Current information	Usage information	Event logs	Calibration status	Connectivity configuration	All pages
Current Substrate, Printhead and Ink Information (1 of 2)						
Date:	Nov 16, 2009 2:31:48 PM	Product:	HP DesignJet L25500 42in Printer	Serial Number:	MY94M09009	
Firmware:	GG-CAL_1.0.0.7	Product number:	CH955A	Service ID:	19145	
Printer status:						Ready - Temp. OK to open window
Current Printer Configuration						
Language:	English	Memory:	256 MB			
Disk capacity:	160 GB					
Current Temperature:	20.0°C ±2°C	Current Humidity:	55% ±15%			
Substrate Loaded Information						
Substrate Path:	Roll	Substrate Loaded Status:	OK			
Substrate Type:	Paper-Aqueous					
Substrate Width:	914 mm / 36.0 inches					
Current Printhead Kit Info (I)						
	Warranty status	Status	Error ID Code	Product Number		
1 - Cyan-Light cyan	In warranty	OK	0	C9481A		
2 - Cyan-Light cyan	In warranty	OK	0	C9481A		
3 - Yellow-Black	Out of warranty	OK	0	C9482A		
4 - Yellow-Black	Out of warranty	OK	0	C9482A		
5 - Magenta-Light magenta	In warranty	OK	0	C9483A		
6 - Magenta-Light magenta	In warranty	OK	0	C9483A		
Current Printhead Kit Info (II)						
	Product Name	Serial Number	Warranty Date			
1 - Cyan-Light cyan	HP 789	4-1-3480030-2-2009	20110114			
2 - Cyan-Light cyan	HP 789	4-1-3480133-2-2009	20110114			
3 - Yellow-Black	HP 789	4-1-3479789-2-2009	20110114			
4 - Yellow-Black	HP 789	4-1-3479797-2-2009	20110114			
5 - Magenta-Light magenta	HP 789	4-1-3717974-9-2009	20110304			
6 - Magenta-Light magenta	HP 789	4-1-3480468-2-2009	20110114			
Current Printhead Kit Info (III)						
	Used non-HP ink	Used expired ink	Ink Used	% warranty used (ml)		
1 - Cyan-Light cyan	false	false	630 ml	65%		
2 - Cyan-Light cyan	false	false	630 ml	65%		
3 - Yellow-Black	false	false	1260 ml	125%		
4 - Yellow-Black	false	false	1240 ml	125%		
5 - Magenta-Light magenta	false	false	800 ml	80%		
6 - Magenta-Light magenta	false	false	820 ml	85%		
Current Printhead Kit Info (IV)						
	Usage Time	Scan Axis	Shutdown			
1 - Cyan-Light cyan	1 h		0			
2 - Cyan-Light cyan	1 h		0			
3 - Yellow-Black	1 h		0			
4 - Yellow-Black	1 h		0			
5 - Magenta-Light magenta	16 h		0			
6 - Magenta-Light magenta	16 h		0			

Current Information (2 of 2)

The second part displays information on the following:

- Current Ink Cartridge Information
- Printhead Cleaning Kit.

Current Substrate, Printhead and Ink Information (2 of 2)						
Date:	Nov 16, 2009 2:31:46 PM	Product:	HP DesignJet L25500 42in Printer	Serial Number:	MY94M09009	
Firmware:	GG-CAL_1.0.0.7	Product number:	CH955A	Service ID:	19145	
Printer status:						Ready - Temp. OK to open window
Current Ink Cartridge Info (I)						
	Status	Product Name	Product Number	Serial Number	Install Date	Warranty Status
Magenta	OK	HP 789	CH817A	858728-14-13	20090610	In warranty
Yellow	OK	HP 789	CH818A	1382712-14-13	20091104	In warranty
Black	OK	HP 789	CH815A	1758812-5-13	20090517	In warranty
Cyan	OK	HP 789	CH819A	1849284-5-13	20090517	In warranty
Light magenta	OK	HP 789	CH820A	1750580-19-13	20091104	In warranty
Light cyan	OK	HP 789	CH819A	1944516-5-13	20090517	In warranty
Current Ink Cartridge Info (II)						
	Expiration Date	Manufacturer	Capacity	Level	Used non-HP Ink	
Magenta	20111010	HP	775 ml	55 %	false	
Yellow	20111011	HP	775 ml	100 %	false	
Black	20110808	HP	775 ml	95 %	false	
Cyan	20110808	HP	775 ml	95 %	false	
Light magenta	20111117	HP	775 ml	100 %	false	
Light cyan	20110808	HP	775 ml	90 %	false	
Printhead Cleaning Kit						
Status:	OK	Level:	6 %	Product Number:	CH821A CH822A	

Printer Usage Information (1 of 3)

This page contains the following information:

- Printer Usage.
- Usage per Printhead Slot.
- Usage per Cartridge Slot.
- Media Usage per Media Type.

Printer Usage: The total amount of media used in the Printer

Printer Usage Information (1 of 3)

Date: Nov 16, 2009 2:35:38 PM Product: HP Designjet L25500 42in Printer Serial Number: MY94M09009
 Firmware: GG-CAL_1.0.0.7 Product number: CH955A Service ID: 19148
 Status: Ready - Temp. OK to open window

Printer Usage

substrate: 492.77 m² / 5304.1 ft² Total number of prints: 540

Usage per Printhead Slot			
Slot	Color	Product Number	Printheads Used
Slot 1	Light cyan-Cyan	C9461A	1
Slot 2	Light cyan-Cyan	C9461A	1
Slot 3	Black-Yellow	C9462A	1
	Black-Yellow	C9462A	1
	Magenta-Light magenta	C9463A	1
	Magenta-Light magenta	C9463A	1

Usage per Cartridge Slot

Product Number	Usage
CH817A	9 Cartridges / 1200 cc
CH818A	8 Cartridges / 1480 cc
CH815A	9 Cartridges / 1380 cc
CH816A	7 Cartridges / 840 cc
CH820A	8 Cartridges / 850 cc
CH819A	4 Cartridges / 610 cc

Media Usage per Media Type

Media Type	Media Used
Paper-Solvent	141.75 m ² / 1525.8 ft ²
Banner	16.70 m ² / 189.0 ft ²
HP Photorealistic-Low temperature substrate	0.78 m ² / 8.2 ft ²

Total Insertions: This is linked with the crane of the Ink Supply Tubes. When the Ink Supply Tubes or ISS PCAs are replaced, the total insertions amount will be reset to zero (0).

The Ink Cartridges This section displays the ink usage per cartridge.

Media Usage per Media Type: It is possible that the sum of the media used for each media type is lower than the total amount of media used in the Printer. This is because only the total media used in the Printer is saved in the backup EEROM which is located in the ISS PCA. When the Hard Disk Drive is replaced, the total media used per media type is reset to zero (0), but the total media used is recovered from the backup EEROM.

Printer Usage Information (2 of 3)

- Spittoon Usage
- Component Usage.
- Preventive Maintenance Usage.
- Job Accounting I.

Printer Usage Information (2 of 3)						
Date:	Nov 18, 2006 2:02:38 PM	Product:	HP DesignJet L2500 4-in Printer	Serial Number:	WY9402003	
Timezone:	SD-CAL_1007	Productnumber:	C4852A	Service ID:	1946	
Printer status:						Ready - Taking On a job or sleep
Spittoon Usage						
High Spittoon:						1044
Component Usage						
Carriage (Pages)	4713	Carriage (Estimated Pages)	4713	Tearing table (Pages)	4713	
Ink tubes (Pages)	4713	Roll (Pages)	4713	Scan motor (Pages)	4713	
Substrate table (Pages)	47	Carriage Distance (m)	7323	Substrate motor (Estimated length)	159	
New motor (Pages)	0	Y-axis Rate (Hz)	18	CMAR (m media length)	170	
CMAR new success count	100	CMAR new failure count	0	Substrate total (m)	8	
Pin Cleaning Cpt (Pages)	228	Pin Cleaning Cpt (m)	340	Pin Cleaning (Carriage)	72	
Roll motor (Pages)	1762	Roll motor (Pages)	867	Printer (Pages)	302	
Disc Detector (Hz)	0	Disc Drive CD (Pages)	215	Disc plate spitter (Pages)	72	
Barcode (Pages)	25	Barcode (Pages)	595	Line sensor (Pages)	0	
SD (Pages)	0	SD reader (Pages)	15	APR pins (Pages)	2	
APR pins (Pages)	940	Heater (Estimated)	17	Heater (Estimated)	21	
Curing (Estimated)	14	Curing (Estimated)	32	Top-coating (Estimated)	20	
Heating (Pages)	888271	Curing (Pages)	888271	Printing time (Pages)	18	
Heater time (Pages)	867	Roll On-Off (Pages)	209	Roll On-Off (Pages)	384	
Roll count	242	Ink consumed total (Pages)	3225732			
Preventive Maintenance Usage						
Preventive Maintenance Kit #1						2%
Preventive Maintenance Kit #2						2%
Preventive Maintenance Kit #3						4%
Preventive Maintenance Kit #4						1%
Job Accounting I						
Job Name	Page Count	Page Size	Page Count	Page Size	Estimated Time	Status
2006-11-08 10:59:12	Menu Map	500pp-4P-8in-H-L	344.3 p	100%	Paper-Aqueous	PRINTED
2006-11-01 10:59:48	Adv_new_substrate_PLYER_Cemo_multiapp	500pp-10P-8in-H-L	481.3 p	100%	Paper-Aqueous	PRINTED
2006-11-02 10:59:31	Current Configuration Page	500pp-4P-8in-H-L	67 p	100%	Paper-Aqueous	CANCELLED
2006-10-14 12:10:51	Menu Map	500pp-4P-8in-H-L	318.4 p	100%	Paper-Aqueous	CANCELLED
2006-10-13 18:51:20	Menu Map	500pp-4P-8in-H-L	138.7 p	100%	HP PhotoGloss Low temperature substrate	PRINTED
2006-10-13 19:21:20	Menu Map	500pp-4P-8in-H-L	210.4 p	100%	HP PhotoGloss Low temperature substrate	CANCELLED
2006-10-08 14:33:38	CMR0000LPR	500pp-4P-8in-H-L	502.3 p	100%	Paper-Aqueous	CANCELLED
2006-10-08 12:32:47	CMR0000LPR	500pp-10P-8in-H-L	487 p	100%	Paper-Aqueous	CANCELLED
2006-10-08 11:21:58	CMR0000LPR	500pp-10P-8in-H-L	338.3 p	100%	Paper-Aqueous	CANCELLED
2006-10-08 11:19:58	DocGATE CMR0000LPR-48in-H-L	500pp-10P-8in-H-L	127.3 p	100%	Paper-Aqueous	PRINTED

Spittoon Usage: This section contains information on the different Spittoons located in the Printer.

Component Usage: A cycle is counted when the Carriage makes one movement to the left of the Printer and then returns to the right will be reset to zero (0).

Preventative Maintenance Usage: Once the value reaches 100%, the corresponding Preventive Maintenance Kit should be used. For further details, refer to Chapter 9 - Preventive Maintenance

Job Accounting: Tracks the usage information for the purposes of accountability

Printer Usage Information (3 of 3)

- Job Accounting II.
- Job Accounting III.

Printer Usage Information (3 of 3)						
Date:	Nov 16, 2009 2:35:38 PM	Product:	HP DesignJet L25500 42in Printer	Serial Number:	MY94M09009	
Firmware:	GG-CAL_1.0.0.7	Product number:	CH955A	Service ID:	19145	
Printer status:						Ready - Temp. OK to open window
Job Accounting(II)						
Date	Substrate(RIP)	Drying/Curing Temp.	Advance Factor	Input Tension	Printzone Vacuum	
2009-11-16 10:59:12		45 °C/70 °C	0.0 mm/m	15 Nm	20 mmH2O	
2009-11-11 10:59:49	Generic Aqueous Semi-Gloss Paper [CMYKcom]	50 °C/60 °C	0.0 mm/m	15 Nm	30 mmH2O	
2009-11-02 10:08:31		45 °C/70 °C	0.0 mm/m	15 Nm	20 mmH2O	
2009-10-14 12:10:51		45 °C/70 °C	0.0 mm/m	15 Nm	20 mmH2O	
2009-10-13 16:33:20		50 °C/60 °C	0.0 mm/m	15 Nm	40 mmH2O	
2009-10-13 16:22:23		50 °C/60 °C	0.0 mm/m	15 Nm	40 mmH2O	
2009-10-09 14:08:36	SOL TEST	45 °C/70 °C	0.0 mm/m	15 Nm	20 mmH2O	
2009-10-09 12:02:47	Paper 2	45 °C/70 °C	0.0 mm/m	15 Nm	20 mmH2O	
2009-10-09 11:22:53	Paper 2	45 °C/70 °C	0.0 mm/m	15 Nm	20 mmH2O	
2009-10-09 11:15:33	Paper 2	45 °C/70 °C	0.0 mm/m	15 Nm	20 mmH2O	
Job Accounting(III)						
Date	RIP and Driver details	Drying airflow	OMAS Navigation	Mute	Speed/Svg	Cutter Used
2009-11-16 10:59:12	-	30 %	Yes	No / No		Yes
2009-11-11 10:59:49	PIDONY1670aPIDHPDRL000 - ONYX 7.3.2.16	30 %	Yes	No / No		Yes
2009-11-02 10:08:31	-	30 %	Yes	No / No		Yes
2009-10-14 12:10:51	-	30 %	Yes	No / No		Yes
2009-10-13 16:33:20	-	30 %	Yes	No / No		Yes
2009-10-13 16:22:23	-	30 %	Yes	No / No		Yes
2009-10-09 14:08:36	FIDCOL1258aPIDHPDRL000 - PRODUCTIONSERVER5 Version: 5.40.2781	30 %	Yes	No / No		Yes
2009-10-09 12:02:47	FIDCOL1258aPIDHPDRL000 - PRODUCTIONSERVER5 Version: 5.40.2781	30 %	Yes	No / No		Yes
2009-10-09 11:22:53	FIDCOL1258aPIDHPDRL000 - PRODUCTIONSERVER5 Version: 5.40.2781	30 %	Yes	No / No		Yes
2009-10-09 11:15:33	FIDCOL1258aPIDHPDRL000 - PRODUCTIONSERVER5 Version: 5.40.2781	30 %	Yes	No / No		Yes

Event Logs

This page contains the following information:

- Last 20 System Error Codes (which prevented the Printer from booting).
- Last 20 System Warnings (which did not prevent the Printer from booting, but which required the user to acknowledge the problem).
- Printhead Error log.
- GPIO Sensor Status.

Event Logs						
Date:	Nov 16, 2009 2:35:27 PM	Product:	HP DesignJet L25500 42in Printer	Serial Number:	MY94M09009	
Firmware:	GG-CAL_1.0.0.7	Product number:	CH955A	Service ID:	19145	
Printer status:						Ready - Temp. OK to open window
Event #	Severity	Error Code	Message	Time Stamp	Time	Time
1	Warning	27162216	GG-CAL_1.0.0.7	491-42211	20091116	20091116
2	Warning	27162216	GG-CAL_1.0.0.7	491-42211	20091108	20091108
3	Warning	27162216	GG-CAL_1.0.0.7	491-42211	20091106	20091106
4	Warning	27162216	GG-CAL_1.0.0.7	491-42211	20091106	20091106
5	Warning	27162216	GG-CAL_1.0.0.7	491-42211	20091106	20091106
6	Warning	27162216	GG-CAL_1.0.0.7	491-42211	20091106	20091106
7	Warning	27162216	GG-CAL_1.0.0.7	491-42211	20091106	20091106

System/Warning Error

- The **Line** and **Internal Code** do not provide much information, but are useful in the case of escalating a problem to the division (different internal error codes can point to the same error code (e.g. 01.10:10)).
- **Media Usage** (in square meters) and **Date** (from the Printer's Internal Clock (RTC)) help you to understand if the Printer has been used (media usage) and how much time has passed since the last error.

Event #	Severity	Error Code	Internal Code	Print Version	Media Usage	Line	Date
1	Warning	20.01	20102001	00-CAL_3.0.22.4	402.129153	\\fs01\psm\log\TARGETS\m-40-005- cpl\extra\pen\m-40-005\Supply\fan\m-40-005\Supply\fan\m-40-005.cpl:247	20141009
2	Warning	20.01	20102001	00-CAL_3.0.22.4	402.129153	\\fs01\psm\log\TARGETS\m-40-005- cpl\extra\pen\m-40-005\Supply\fan\m-40-005\Supply\fan\m-40-005.cpl:247	20141009
3	Warning	02.01	27180003	00-CAL_1.0.0.1	402.700000	\\fs01\psm\log\TARGETS\m-40-005- cpl\extra\pen\m-40-005\Supply\fan\m-40-005\Supply\fan\m-40-005.cpl:247	20091118
4	Warning	02.01	27180003	00-CAL_1.0.0.1	402.700000	\\fs01\psm\log\TARGETS\m-40-005- cpl\extra\pen\m-40-005\Supply\fan\m-40-005\Supply\fan\m-40-005.cpl:247	20091118
5	Warning	03.1.10	271711107	00-CAL_1.0.0.1	401.422211	\\fs01\psm\log\TARGETS\m-40-005- cpl\extra\pen\m-40-005\Supply\fan\m-40-005\Supply\fan\m-40-005.cpl:247	20091112
6	Warning	03.1.10	271711107	00-CAL_1.0.0.1	401.422211	\\fs01\psm\log\TARGETS\m-40-005- cpl\extra\pen\m-40-005\Supply\fan\m-40-005\Supply\fan\m-40-005.cpl:247	20091112
7	Warning	03.1.10	271711107	00-CAL_1.0.0.1	402.700000	\\fs01\psm\log\TARGETS\m-40-005- cpl\extra\pen\m-40-005\Supply\fan\m-40-005\Supply\fan\m-40-005.cpl:247	20091111

Printhead Error Log

- Printheads ago: History of the last three Printheads used ('0' represents the current Printhead used).
- **Status:** '0' = Working, '1' = No Pen Detected, '2' = Replace, '4' = Reset, '8' = Remove.
- **% Ink Used:** Percentage of the Warranty life (1000cc).
- **Error Code:** Specific error code generated by the Printer when the Printhead has been replaced.
- **Max Recovery:**
 - 0: No manual Printhead recovery has been performed on the Printhead.
 - 1 or higher: At least one Printhead recovery has been performed.

Printhead Error Log							
Printhead name	Serial Number	Status	Usage time	% Ink Used	Max Recovery Level	Error Code	
1 - Cyan-Light cyan	4-1-3480030-2-2009	0	1 h	82	2	0	
	4-1-3480133-2-2009	0	16 h	29	1	0	
2 - Cyan-Light cyan	4-1-3480133-2-2009	0	1 h	82	2	0	
	4-1-3480030-2-2009	0	16 h	29	1	0	
3 - Yellow-Black	4-1-3479797-2-2009	0	1 h	125	2	80000	
	4-1-3479797-2-2009	0	16 h	60	1	0	
4 - Yellow-Black	4-1-3479797-2-2009	0	1 h	123	2	80000	
	4-1-3479797-2-2009	0	16 h	81	1	0	
5 - Magenta-Light magenta	4-1-3717974-9-2009	0	16 h	79	2	0	
	4-1-3480458-2-2009	0	0 h	39	1	0	
6 - Magenta-Light magenta	4-1-3480458-2-2009	0	16 h	81	2	0	
	4-1-3717974-9-2009	4	0 h	38	1	20	

GPIO Log

GPIO Sensors					
Name	Value	Units	Name	Value	Units
FsuTensionState	true	binary	FsuAbrFanState	false	binary
FsuAnalogFanState	false	binary	HumiditySensor	55430	mV
PresenceSensorPen0	true	binary	PresenceSensorPen1	true	binary
PresenceSensorPen2	true	binary	PresenceSensorPen3	true	binary
PresenceSensorPen4	true	binary	PresenceSensorPen5	true	binary
AgePressureSensor	82	mV	TemperatureSensor	20320	mV
PresenceSensor0	false	binary	BrokenBagSensor0	false	binary
IlsSensor0	258	mV	IlsTempSensor	-2147483648	mV
IlsOffset0	1940	mV	PresenceSensor1	false	binary
BrokenBagSensor1	false	binary	IlsSensor1	382	mV
PresenceSensor2	false	binary	BrokenBagSensor2	false	binary
IlsSensor2	150	mV	PresenceSensor3	false	binary

Calibrations Status

This page contains the following information:

- General Calibrations (performed by Service Engineers).
- Diagnostic Log

Current configuration	Current information	Usage information	Event logs	Calibration status	Connectivity configuration	All pages
Calibrations Status						
Date:	Nov 18, 2009 2:40:54 PM	Product:	HP DesignJet L26500 42in Printer	Serial Number:	MY94M09009	
Firmware:	GG-CAL_1.0.0.7	Product number:	CH955A	Service ID:	19145	
Printer status:	Ready - Temp. OK to open window					
General Calibrations						
Printhead alignment	Recommended	Drop Detector calibration	done	Line Sensor calibration	done	
Diagnostic Log						
Date	Time	Name	Result			
2009-11-11	16:45:59	diagOMAS	OK			
2009-11-11	16:51:53	diagOMAS	OK			
2009-11-11	16:54:42	diagOMAS	OK			
2009-11-11	17:24:49	diagCuring	OK			
2009-11-11	17:29:20	diagCuring	OK			
2009-11-11	17:41:30	diagShuttleCloseLoop	OK			
2009-11-11	17:45:15	diagShuttleCloseLoop	FAILED			
2009-11-11	17:49:46	diagShuttleCloseLoop	FAILED			
2009-11-11	17:54:04	diagShuttleCloseLoop	FAILED			
2009-11-11	17:57:51	diagShuttleCloseLoop	FAILED			
2009-11-11	18:02:15	diagShuttleCloseLoop	FAILED			
2009-11-11	18:39:37	diagOMAS	OK			

General Calibrations

- **Printhead Alignment** relates to the Printhead Alignment which changes to 'pending' when a Printhead is replaced and the Printhead Alignment has not been performed.



NOTE: When a component is replaced, the corresponding calibration is NOT automatically set to 'NOT DONE'. This is because the Printer does not know that there is a new part installed.

- **Drop Detector** relates to the Drop Detector or Service Station calibration.
- **Line Sensor** relates to the Line Sensor Calibration.

Diagnostic log

This section displays the details of the Calibrations that have been performed on the printer, it also contains useful information, such as if the particular calibration was successful or not.

Connectivity Configuration

This page contains full details of the current configuration of the Printer.

Current configuration	Current information	Usage information	Event logs	Calibration status	Connectivity configuration	All pages
-----------------------	---------------------	-------------------	------------	--------------------	----------------------------	-----------

Connectivity Configuration

Date: Nov 16, 2009 2:41:15 PM Product: HP DesignJet L25500 42in Printer Serial Number: MYS4M09009
 Firmware: GG-CAL_1.0.0.7 Product number: CH955A Service ID: 19145
 Printer status: Ready - Temp. OK to open window

```

===== IO DIAGNOSTIC PAGE =====
----- Gigabit Ethernet -----
Installed:                yes
IP enabled:               yes
Printing enabled:        yes
Firewall enabled:        yes
    
```

Connectivity Configuration

Date: Nov 16, 2009 2:41:15 PM Product: HP DesignJet L25500 42in Printer Serial Number: MYS4M09009
 Firmware: GG-CAL_1.0.0.7 Product number: CH955A Service ID: 19145
 Printer status: Ready - Temp. OK to open window

```

===== Gigabit Ethernet =====
----- General Information -----
Status:                    I/O Card Ready
Model Number:              CH955A
Hardware Address:         0040CA4444FF
Firmware Version:         GG-CAL_1.0.0.7
Port Config:              100TX FULL
Auto Negotiation:         On

----- Security Settings -----
SNMP Set Cmty Name:       Not Specified
SNMP Get Cmty Name:       Not Specified

----- Network Statistics -----
Total Packets Received:   31158
Unicast Packets Received: 30672
Bad Packets Received:     0
Framing Errors Received:  0
Total Packets Transmitted: 1321
Unsendable Packets:       0
Transmit Collisions:      0
Transmit Late Collisions: 0

----- TCP/IP -----
IPv4:                      Enabled
IPv6:                      Enabled
Host Name:                 NPI0040CA4444FF
IPv4 Domain Name:         emea.hpqcorp.net
IPv6 Domain Name:         Not Specified
Primary DNS Server:       16.110.135.52
Secondary DNS Server:     16.110.135.51
DNS (IPv6):               Not Specified
WINS Server:              Not Specified
Idle Timeout:             270 sec

----- IPv4 -----
Status:                    Ready
IP Address:                16.23.113.113
Subnet Mask:               255.255.248.0
Default Gateway:          16.23.112.1
Config By:                 DHCP
DHCP Server:              16.228.51.290
Bonjour Service Name:     Not Specified

----- IPv6 -----
Status:                    Ready
Link-Local:
fe80::240:caff:fea4:44ff
Stateless:
Not Configured
DHCPv6:
Not Configured
Manual:
Not Configured
    
```

How to troubleshoot the 79:04 System Error

Introduction

The System error 79:04 is a generic firmware error (equivalent to a blue screen in Windows). It's the System Error that the printer will display when an unknown exception occurs that cannot be pointed to by any specific subsystem of the printer.

Since this is a generic error, there can be multiple causes behind it. This document will cover the most probable causes behind a system error 79:04 and will recommend the most efficient troubleshooting steps to resolve customer issues.

One important point to mention is that, although 79:04 system errors can be caused by a hardware malfunction, the vast majority of 79:04 system errors are pure software or firmware issues. In these cases the issue can only be solved by determining the root cause and implementing a solution. The solution can usually be applied by either correctly configuring a selection, updating the printer's firmware/software that is being used or by fixing an error in the code).

Possible causes

Since the 79:04 system error is a generic error, the number of possible causes behind it is large. The majority can be grouped, however, into the following groups:

Data related SE79:04

HP Designjet printers have Hard Disks and non volatile memories that contain data bases and files that can be modified with user data. Some examples include:

- The data base that stores the printer settings
- The data base that stores accounting information

Some of this data is accessed by the printer at start up, and some others are accessed as needed.

If any of this fields contains corrupt data or data with characters or values that cannot be correctly processed by the printer, a 79:04 system error may occur.

Possible symptoms

There are two different types of symptoms for data related 79:04 system errors:

1. When the corrupt data is accessed during start up:
 - a. The printer will display a 79:04 during the start up process
 - b. Switching the printer off and on again will not solve the issue. The printer will continue displaying the 79:04 system error until the corrupt data has been cleared through a service procedure
2. When the corrupt data is accessed during normal printer operation
 - a. The printer will start up normally
 - b. When the data is accessed (for example while printing, when changing some settings, the printer displays a 79:04 system error
 - c. The printer can reboot normally
 - d. When the data is accessed again (typically, under the same conditions as in step "b"), the 79:04 system error is displayed again

Solutions and workarounds

Many times, data related 79:04 errors are resolved by means of hardware intervention. Since data is stored in physical components (RAM, EEROM and Hard Disk), replacing these components with new ones which are empty usually solves the problem. However, there are quicker and more effective solutions to these types of errors:

1. Clear all information that has been introduced by the user using the standard tools available in the printer:
 - a. Reset to factory defaults to clear the user's configurations and calibrations: Go to the **Setup icon>Resets>Restore Factory Settings**.
 - b. Delete any non standard paper preset in the printer (both the ones that have been created by the user and the ones that have been installed as OMES profiles through the EWS or the HP Printer Utility)
2. If step 1 did not resolve the issue, you can use Service Tools to clear additional information that could be causing the issue:
 - a. Start the printer in Diagnostics Boot Mode
 - b. Perform an 2.10 EEROM reset

Important note:

It is possible that the corrupt data came to be in the printer as a consequence of some activity in the customer's workflow. In this case, it is possible that the issue will happen again. In these cases, it is very important to understand the sequence of events in the customer's workflow that led to the error occurring. Once the error can be traced in the customer's workflow, escalate the issue to the GBU (through the GCC). This is done to implement any changes in the printer's firmware that can prevent these issues occurring again.

Network related SE79:04

Most HP Designjet printers have built-in networking capabilities. Network settings can be set manually, but in the majority of cases, they are obtained automatically from the printer. These settings include many different fields, such as IP address and subnet mask, available gateways, host and domain names, etc.

In some cases, there can be issues in the firmware that can cause a certain value in one of these fields to be interpreted incorrectly, and this can lead to a 79:04 system error.

Symptoms

There is no single set of symptoms that can absolutely pinpoint a network related 79:04 system error. However, the following guidelines can be applied:

- It can happen at start up or when accessing the Network Configuration section of the FP
- In both cases, repeating the action with the LAN cable disconnected does not cause the 79:04 to occur

Solutions and workarounds

In the majority of cases, these issues will be due to an issue in the printer's firmware. As soon as the conditions where the issue happens can be understood, it should be escalated to the GBU through the GCC.

At the same time, the following short term solutions and workarounds can help the customer to get up and running in the shortest possible time:

1. Disconnect the network cable to be able to boot the printer and change network settings
2. In the Network configuration menu in the Front Panel, disable any protocols that you are not using, including SNMP and WebServices.
3. If step "2" does not work, try setting a manual configuration of the device:

- a. Enter the correct subnet mask and an IP in the valid range
 - b. In the GateWay field, set the same value as in the IP address field
 - c. Do not set a host name or a domain name
4. If step "3" does not work and the customer is using the network card which is part of the printer, try using an accessory Jetdirect card instead.

User Interaction related SE79:04

In some cases the printer may not react as expected when a certain set of conditions coincide. In these cases, if the printer doesn't know how to react, it may simply display a 79:04 system error and force a reboot. Some examples (not real) that can help to illustrate this:

- An error occurs when a job is cancelled when it is at the "Finishing print" state.
- An error occurs if the Window is opened while the printer is checking the printheads

These errors will most likely only happen in very specific corner cases that have not been identified during the development or the qualification of the printer, so normally, they do not severely impact the customer, as they do not affect their regular working flows.

Symptoms

The symptoms here are as numerous as the number of possible interactions between the user and the printer. In any case, it's possible to identify the steps that caused the error to occur and avoid them as the steps will always be the same with no variance.

Important: A major element in determining the error is what the state the printer was in at the time the error was displayed. Actions the user has made when the printer is drying for example can produce an error, whereas the same action when the printer is doing something else (or is idle) may not produce any errors.

Solutions and workarounds

The recommended action plan in these cases is to identify the previous steps that caused the error and:

1. Escalate the issue to the GBU through the GCC in order to have it corrected in the firmware.
2. Recommend to the customer that they try to avoid the same steps to prevent the issue
3. If the conditions that cause the error are in the customer's regular workflow, try to identify a different way of achieving the same result out of the printer.

Random SE79:04: Concurrency issues and memory leaks

Some 79:04 errors can happen randomly when the printer is being heavily used. However, it's impossible to find a single set of conditions that reproduce the problem. It just happens from time to time, without a defined pattern.

These random 79:04 can have two different types of root causes:

- **Memory leaks:** before a program is executed, it allocates the memory it will need. After the execution is complete, the allocated memory is freed to be used by other programs. If the allocation or the release of the memory are not properly programmed, every time the program is executed some memory will be incorrectly labeled (either as used or as free). This is known as a memory leak. When a program with a memory leak is executed a lot, the memory becomes progressively full (since it is not properly freed). When the leak becomes too big, the printer is left 'out of memory' to execute new processes and a 79:04 is triggered
- **Concurrency issues:** there are certain resources that can be accessed by multiple programs or by multiple executions of the same program (what is known as multiple threads). Access to these

resources must be correctly controlled to prevent unexpected behavior. Issues caused by an incorrect control of these resources are concurrence issues.

Symptoms

This type of 79:04 always occurs in heavy load conditions, so the symptoms will always be similar to this pattern:

- A printer that is being heavily used (printing a project or in a reprographics environment) produces 79:04 errors randomly, forcing the user to reboot.
- After rebooting, the printer can be used without any issues for an extended period of time, but if the workload is consistently high, a random error will occur again.
- The error can never be associated with a specific file. The file that was being printed when the error occurred the last time can be printed without issues after reboot. And a file that has been printed without issues several times can trigger the error in the future.
- This error is very dependant of the workflow the customer has. The most common user work flows have been extensively tested both by HP and by our beta sites, so it is highly unlikely to see random 79:04 issues in these cases. These random issues tend to occur in very specific corner cases, and cannot be reproduced unless the exact conditions of the workflow are replicated.

Workarounds and solutions

Random 79:04 errors are, by far, the most complex ones to diagnose and to fix. The only solutions available in these cases are:

1. Identify the root cause (either in the files or in the firmware) and fix it in the code, which requires the intervention of the GBU.
2. Test any options available to modify the customer's workflow and see if any combination of them solves the issue.

In both cases, a profound understanding of the customer's workflow is necessary. In particular, the information that is needed is:

- Printer front panel settings.
- RIP settings.
- Type of output files the RIP is generating.
- Some sample files that are representative of what the customer is using.
- Operating System.
- Method of connection to the printer.
- A description of the normal flow when the issue occurs and the typical frequency of occurrence (i.e. once every hour when sending non stop several files, each of them with multiple copies)

With this information, the environment can be replicated in order to try and find workarounds. This is also the information that will be needed at the GBU to investigate and fix the root cause of this issue once it is escalated.

Hardware related SE79:04

Hardware is, by far, the least likely cause of a 79:04 system error. Replacing hardware components does not normally fix the issue and increases the total turn around time in finding a workable solution.

In some cases, a failure in a component in the printer's electronics may cause a 79:04 system error, since the printer's electronics are involved in the execution of the firmware and the processing of jobs. It needs to be noted, however, that hardware failures in the electronics tend to produce specific system errors that point directly to the component that is failing.

Some HW causes that could be behind a 79:04 error are:

- Defective clusters in the Hard Disk drive. If these clusters are used to execute the firmware or to process a job, they may produce a 79:04. It needs to be noted however, that most 79:04 errors that are resolved by an HDD replacement are in fact, data related 79:04 that could have been solved more efficiently and quickly following the steps in Section 3.
- Defective memory segments. If the RAM memory has some defective segments, a 79:04 may occur when these segments are used.
- Intermittent defects in the electronic components that are involved in the processing of a job: Carriage PCA, Trailing cable, Formatter and PrintMech. This is a highly unlikely cause, since defects in these components will produce subsystem specific errors.

Symptoms

There's no single set of symptoms behind hardware related 79:04 system errors. The most usual ones, however are:

- 79:04 during start up. Rebooting the printer may or may not solve the problem
- 79:04 while processing or printing a job. Rebooting the printer and printing the same job does not always produce the error.

Solutions and workarounds

In the following procedure perform each step as it appears in the list and only move on to the next step once you are sure the 79:04 error has not been cleared:

1. Reboot the printer in Diagnostics Boot mode and execute the service tests to validate the functionality of all the electronics components
 - Execute the troubleshooting for "data related" system errors, refer to previously.
2. Replace the memory
3. Replace the HDD
4. Escalate the issue before replacing any additional parts.

Troubleshooting based on symptoms

This section will describe which troubleshooting steps to perform for a 79:04 system error based on the symptoms of the issue. Perform each step as it appears in the list and only move on to the next step once you are sure the 79:04 error has not been cleared:

Front panel displays 79:04 at Start-up

- Reboot the printer twice. If the System error has been caused by a job because its in an incorrect format, rebooting twice will clear the error (the first time after reboot, the printer will attempt to print the job again, and this will cause the error to re-appear). If rebooting the printer twice solves the issue, then it is an issue related to the job and you should refer to page 2, Job related SE79:04.
- Upgrade the printer's firmware. Even if the currently installed firmware version is the latest one, re-install it. Since the printer cannot start normally, you will need to upgrade the firmware while booting the printer in Diagnostics Boot Mode. For this, a special file and a special upgrade process will be needed.
- Disconnect the network cable and restart the printer. If this solves the problem, then it is a network related 79:04 and you should follow the guidelines for this type of 79:04 on page 4, Network related SE79:04

1. Remove all cartridges, printheads and printhead cleaners (if available). Unload the media. Restart the printer. If the printer can start normally, insert the consumable one by one until you isolate the one that is causing the error. Do NOT insert any of the replaced consumable in another printer
2. Restart the printer in Diagnostics Boot Mode and perform the "2.2 Electronics control". If an electronic component is identified as faulty, replace it.
 - Restart the printer in Diagnostics Boot Mode and Reset the EEROM "2.10 EEPROM reset". If the issue is solved by this, this is a data related 79:04 system error and you should follow the guidelines, refer to previously for Data related SE79:04.
3. If the unit has been used for some time and suddenly has started to show this behavior, replace the Hard Disk Drive.
4. If the issue is new and the issue happens since the first boot, do NOT replace the HDD.
5. If none of the previous steps solved the issue, escalate the issue with the following information:
 - Unit information: S/N, P/N, accessories
 - Conditions where the problem occurs and conditions prior to the first occurrence of the problem
 - The results of the previous 8 steps
 - The System Error detailed information (this can be obtained by pressing CANCEL + Down)
 - The printer logs.

Front panel displays 79:04 during printer operation – not while sending jobs

1. Reboot the printer.
2. Upgrade the printer's firmware. Even if the currently installed firmware version is the latest one, re-install it.
3. Reset the printer to factory defaults: Go to the **Setup icon>Resets>Restore Factory Settings**.
4. In order to narrow the scope of the issue, try the following:
 - a. Disable any unused network protocols
 - b. Disable SNMP and WebServices.
 - c. Disable "Sleep mode" from the Service Utilities menu (1.2.6 Sleep Mode)
5. Restart the printer in Diagnostics Boot Mode and perform the "2.2 Electronics control". If an electronic component is identified as faulty, replace it.
6. Restart the printer in Diagnostics Boot Mode and Reset the EEROM "2.10 EEPROM Reset". If the issue is solved by this, this is a data related 79:04 system error and you should follow the guidelines for this type error on page 3, Data related SE79:04.
7. Try to identify the combination of settings or actions that led to the system error and try to reach the same result with a different combination. Escalate the issue to fix the original problem.
8. If none of the previous steps could solve the issue, escalate it with the following information:
 - Unit information: S/N, P/N, accessories
 - Conditions where the problem occurs and conditions prior to the first occurrence of the problem
 - The result of the previous 8 steps
 - The printer information pages (either printed and faxed or obtained through the Embedded Web Server)
 - The System Error detailed information (it can be obtained by pressing CANCEL + Down)

- The printer logs.

Front panel displays 79:04 while printing

A. While printing a single job

The error happens after a single job is sent. It's easy to identify which job that has produced the error, since every time that this same job is sent, the error is replicated.

B. Random 79:04 during continuous printing

The error does not happen with a single job. It happens randomly during continuous printing, normally while the printer is managing a heavy load (printing a project or in a reprographics environment).

This type of error is caused either by memory leaks or by concurrence issues in the printer's firmware. They normally happen in non common environments where these memory leaks or concurrence issues that have not been detected during qualification have occurred. These issues cause the printer to crash at a completely random moment during printing, and are not associated to a specific job.

1. Reboot the printer.
2. Upgrade the printer's firmware. Even if the currently installed firmware version is the latest one, re-install it.
3. Escalate the issue, providing the following information:
 - Unit information: S/N, P/N, accessories
 - Conditions where the problem occurs and conditions prior to the first occurrence of the issue.
 - The result of the previous 7 steps
 - The printer information pages (either printed and faxed or obtained through the Embedded Web Server)
 - The System Error detailed information (it can be obtained by pressing CANCEL + Down)
 - Information on the workflow:
 - Operating System
 - RIP
 - RIP Driver version
 - Settings in the driver and the application
 - Settings in the RIP
 - Connection method and settings:
 - The original file along with the information on how to reproduce the issue
 - A print to file that can reproduce the issue
 - The printer logs.

3 System Error Codes

- Introduction..... 75
- System Error Codes and Warnings - Explanation 75
- Continuable and Non-Continuable Error Codes 78
 - 01.0:03 - Error impact I2C channel..... 78
 - 01.0:10 - Problem with the Sausalito PCA..... 78
 - 01.1:10 - Problem with the Printmech PCA 78
 - 01.02:10 - ISS PCA Problem 78
 - 02.01:10 - Problem with the Carriage PCA 79
 - 03:10 - Problem with the PSU..... 79
 - 05.1:10 - Problem with the CPU Fan..... 79
 - 05.3:10 - Main memory size failure 80
 - 06.03 - NVM file has a bad CRC..... 80
 - 06:10 - Main NVM failure..... 80
 - 08:11 - Connection problem with the Front Panel..... 80
 - 09.01:10 - TOMAS Error 81
 - 11:10 - Connection problem with the Trailing cable..... 81
 - 14.01:00 - Temperature high on the Heat sink 81
 - 14.02:00 - Current too high on the Dryer Assembly 82
 - 14.03:00 - Current too high on the Curing Module 82
 - 14.04:00 - AC Voltage too high on the Dryer Assembly 82
 - 14.05:00 - AC Voltage too low on the Dryer Assembly..... 82
 - 14.06:00 - One or more heaters are not connected 83
 - 14.07:00 - Connection problem with Heaters Control assembly 83
 - 14.08:00 - No AC voltage in the Dryer Assembly..... 83
 - 14.09:00 - Heaters Control PCA is not ready 84
 - 14.10:00 - Open circuit on the Dryer Assembly..... 84
 - 14.11:00 - Open circuit in the Curing Module 85
 - 14.12:00 - Petisa Fan Fault 85
 - 14.13:00 - Current Leak in Drying Channel 85
 - 14.14:00 - Current leak in the Curing Module..... 85
 - 14.15:00 - Generic failure with the Heaters Control Assembly..... 86
 - 14.16:00 - AC voltage too high on the Curing Module 86
 - 14.17:00 - AC Voltage too low on the Curing Module 86
 - 15.01:00 Drying system warm up timed out 87
 - 15.02:00 - Drying system cool down time out..... 87
 - 15.03:00 - Drying system temperature too high 87
 - 15.04:00 - Drying system temperature too low 88
 - 15.05:00 - Problem with the Drying System Temperature Sensor 88
 - 15.06:00 - Temperature error detected 89
 - 15.08:00 - Dryer fans not connected 89
 - 15.09:00 - Drying fans failure 89
 - 15.10:00 - Drying Assembly resistors incorrect 90
 - 16.01:00 - Curing Module warm up time out..... 90
 - 16.02:00 - Curing system cool down time out..... 91
 - 16.03:00 - Curing system temperature too high 91
 - 16.04:00 - Curing system temperature too low (below 5C)..... 91
 - 16.05:00 - Problem with the Curing System Temperature Sensor 92
 - 16.06:00 - Temperature error detected 92
 - 16.08:00 - Curing System fans not connected 93
 - 16.09:00 - Curing System fans failure 93
 - 16.10:00 - Curing Assembly resistors incorrect..... 93
 - 21.02:10 - Problem with the Web Wipe motor 94
 - 21.03:10 - Electrical problem in the Web Wipe Motor 94
 - 21.05:03 - Web Wipe Assembly Drifting..... 94
 - 21:10 - Problem in the area of the Service Station..... 94
 - 21:13 - Problem in the Service Station 95
 - 23:10 - Problem with pressurization in the APS 95
 - 23:10 - Problem with pressurization in the APS 95
 - 24:03 - Ink Seup Failure..... 95
 - 24:10 - Ink Cartridge Broken Bag 96
 - 24.02:00 - Top Cover Fans array is not connected..... 96

• 24.03:00 - One of the Top Cover Fans not connected.....	96
• 26.00:10 - Contact failure with Magenta Ink Cartridge.....	97
• 26.01:10 - Contact failure with Yellow Ink Cartridge.....	97
• 26.02:10 - Contact failure with Black Ink Cartridge.....	97
• 26.03:10 - Contact failure with Cyan Ink Cartridge.....	98
• 26.04:10 - Contact failure with Light Magenta Ink Cartridge.....	98
• 26.05:10 - Contact failure with Light Cyan Ink Cartridge.....	99
• 26:14 - An incorrect Ink Cartridge has been detected.....	99
• 27:14 - An incorrect Printhead has been detected.....	99
• 29:02 - Printhead Cleaning Cartridge almost finished.....	99
• 32:01:01 - The substrate printed on is too small.....	100
• 32:01:02 - Problem with the Take Up Reel.....	100
• 32:01 - Take Up Reel disconnected.....	100
• 32:02 - Take Up Reel disconnected at initialization.....	101
• 41:03 - Limited electrical voltage at the Media Axis motor.....	101
• 41:10 - Electrical fault at the Media Axis motor.....	101
• 42:03 - Problem with the Scan Axis Motor.....	101
• 42:10 - Electrical fault in the Scan Axis area.....	102
• 43:10 - Problem with the Vacuum Fan.....	102
• 44:10 - There is a problem with the Aerosol Fan.....	102
• 44:11 - Connection problem with the Aerosol Fan.....	103
• 45.01:00 - Rewinder Servo Shutdown.....	103
• 45.02:10 - Rewinder inverse polarity.....	103
• 45.03:00 - Rewinder driver system fault.....	103
• 46:03 - Primer Servo shutdown.....	104
• 46:10 - Electrical fault in the Primer motor.....	104
• 46:13 - Primer distance failed.....	104
• 50:01 - OMAS Navigation failure.....	104
• 50:03 - Internal electrical connection problem.....	105
• 50.01:10 - Connection problem with OMAS.....	105
• 50.01:11 - Error with Media Advance Sensor or with cable.....	105
• 50:11 - Media navigation problem.....	106
• 50:14 - Firmware version mis-match.....	106
• 50.02:10 - Problem with OMAS Controller PCA.....	106
• 51:10 - An error has been detected with the Window Lock Sensor.....	107
• 51.01:10 - Problem with the Service Station door sensor.....	107
• 52:01 - A problem with the Drop Detector.....	107
• 52:10 - A problem with the On/Off switch in the Drop Detector.....	107
• 53:10 - Problem with the Media sensor.....	108
• 54:10 - Problem with the Media lever sensor.....	108
• 55:10 - Problem with the Line Sensor.....	108
• 56:10 - Analog encoder calibration has failed.....	108
• 58:10 - Problem with the Color Sensor.....	109
• 61:01 - Problem with the format of the file.....	109
• 61:08.01 - Job is password protected.....	109
• 61:09 - Communication with the RIP broken.....	110
• 63:04 - Network problem.....	110
• 63:05 - The raster data does not arrive quick enough.....	110
• 65:04 - I/O port problem.....	110
• 66:08 - Cannot print on the current type of media.....	111
• 71:19 - Mis-match of printer information.....	111
• 72:04 - Generic firmware error.....	111
• 73:03 - Problem with the Carriage encoder.....	111
• 74:01 - Error upgrading firmware file.....	112
• 74:04 - Request to upgrade the firmware.....	112
• 77:04 - Embedded Web Server internal software error.....	112
• 78.01:04 - Media settings error.....	112
• 78.02:01 - End of roll detected on the Rewinder.....	112
• 79:03 - Generic firmware error I.....	113
• 79:04 - Generic firmware error II.....	113
• 81:01 - Problem with the Media Drive.....	113
• 81:03 - Problem with setting the encoder position.....	113
• 82:01 - Media jam in the platen.....	114
• 85:03 - Drive Roller encoder problem.....	114
• 86:01 - Carriage servo shutdown.....	114
• 93:11 - Unable to pressurize the IDS.....	114

Introduction

System error codes are hexa-decimal based numbers generally caused by internal system errors. The following pages contain a list of system error codes and their respective descriptions and recommended corrective actions. Only try one recommended action at a time and check if the issue causing the error code has been solved.

If you have an error code which is not documented in this Service Manual or you have an error which you cannot resolve, then report the error to the HP Response Center or the nearest HP Support Office. When reporting the error, have the following information ready:

- Model and Serial Number of the printer.
- Which firmware revision the printer is using (See Note below). Check firmware in *Setup Menu / Information Menu / Show Printer Information*.
- The complete error number (see note below).
- The Service Configuration Print.
- The Current configuration sheet.
- Which software application the customer is using (name, version, etc).



NOTE: When reporting the System Error Code, make sure that you supply the full Internal Error Code and the firmware version. Without this information, HP Support Personnel cannot help you. To view the Internal Error Code, hold the DOWN key and press the CANCEL key at the same time when the System Error Code is displayed on the Front Panel.

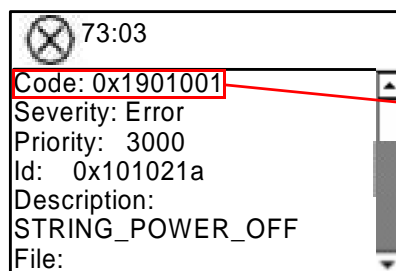

This is the Code that is required when escalating a problem

System Error Codes and Warnings - Explanation

System Error Codes explain which component/system is failing and what action should be taken to resolve the problem.

System Error Codes are displayed directly on the front panel (but can also be seen on the Information Page) and have been defined in the format **XX.YZ**. or **XX.n:YZ.m**.

- **XX**: Service Part (2 digits).
- **n**: Service Part Index (if more than one used in the product) - Optional.
 - e.g. Identify the Ink Supply (color and number).
- **Y**: Who should perform the action (1 digit) - (User or Service Engineer).
- **Z**: Action to perform (1 digit).
- **m**: additional actions/information to consider (1 digit) - Optional.

- e.g. Non-authorized ink was detected, PM was triggered or Printhead in/out of Warranty.

The following table explains the **XX** part of the System Error Code or Warning:

Code	Component/System
01.0	Main PCA/Electronics Module (Sausalito)
01.1	Add-on Electronics Module (Printmech)
01.2	ISS Electronics Module
02.1	Carriage PCA
03	Power Supply Unit
05.1	Fan of the Formatter
05.3	Memory of the Formatter
06	Hard Disk Drive
07	Interconnect PCA
08	Front Panel
09	Vacuum
11	Trailing Cable
14	Heaters Control Assembly
15	Drying System
16	Curing System
21	Service Station
23	Pressure System (APS)
24	Ink Delivery Tubes
26.n	Ink Cartridge (color n)
27.n	Printhead (color n)
29	Printhead Cleaning Maintenance Cartridge
31	Cutter
32	Take Up Reel
41	Paper-Axis Motor
42	Scan Axis Motor
43	Vacuum Fan
44	Aerosol Fan
45	Rewinder
46	Primer
50	OMAS
51	Window/Door Sensor
51.01	PHC Access Door Sensor
52	Drop Detector
53	Media Sensor
54	Media Lever Sensor
55	Line Sensor
56	Drive Roller Encoder Sensor
58	Color Sensor
61	Language Interpreting
61.1	PS Fonts Missing
61.2	File with Passwords cannot be Printed
63	Input/Output through LAN Card
65	Input/Output (not know what port)
66	Print Job Configuration

Code	Component/System
71	Memory Management
72	Generic Firmware
73	Motor Control Functions
74	Firmware Upgrade
77	WebAccess Application
78	Borderless
79	Assertion (Uncontrollable Firmware Error)
81	Media Advance
82	Media Jam
85	Media-Axis Encoder Reading
86	Carriage Movement
93	Ink Pumping
97	Automatic Paper advance Calibration

The following table explains the **YZ** part of the System Error Code or Warning:

Code	Recovery Action	Response
00	Replace	
01	Reseat/Reconnect/Clean/Adjust (manually)	
02	Calibrate/Adjust (using Automatic Process)	
03	Power OFF and Restart the Printer	
04	Upgrade System Firmware	Possible for customer to perform action
05	Upgrade Driver or Computer Software	
06	Add Accessory	
07	Escalate	
08	Send Plot Again	
09	Wrong Part Installed	
10	Replace	
11	Reseat/Reconnect/Clean/Adjust (manually)	
12	Calibrate/Adjust (using Automatic Process)	
13	Power OFF	
14	Upgrade System Firmware	hp qualified personnel assistance required
15	Upgrade Driver or Computer Software	
16	Add Accessory	
17	Escalate	
18	Send Plot Again	
19	Wrong Part Installed	

Continuable and Non-Continuable Error Codes

Some of the Error Codes are continuable, which means you can press **Enter** on the front-panel and continue working with the Printer. Non-Continuable Error Codes do not allow you to continue working with the Printer, in this case power the Printer OFF and ON again and see if the System Error disappears. If the Error Code reappears, then the Printer requires an on-site visit in order to resolve the problem.

Important note: If the solution calls for a replacement part, replace one component at a time and check if the error has been cleared before replacing another component. Using this procedure you will be able to determine exactly which component has failed.

SE Code: 01.0:03 - Error impact I2C channel

Problem Description:

There is an error with a board in the Electronics Module.

Corrective Action:

- Switch the Power OFF from the back of the Printer and disconnect the Power cord. Reconnect the power cord and power On the Printer.
- If the System Error continues, replace the Sausalito PCI PCA ⇒ Page 444.

SE Code: 01.0:10 - Problem with the Sausalito PCA

Problem Description:

The Sausalito PCI PCA has failed

Corrective Action:

- Switch the Power OFF from the back of the Printer and disconnect the Power cord. Reconnect the power cord and power On the Printer.
- Replace the Sausalito PCI PCA ⇒ Page 444.
- If the System Error continues, replace the Main PCA ⇒ Page 450.

SE Code: 01.1.10 - Problem with the Printmech PCA

Problem Description:

The PrintMech PCA has failed to respond.

Corrective Action:

- Switch the Power OFF from the back of the Printer and disconnect the Power cord. Reconnect the power cord and power On the Printer.
- Check that the cables between the PrintMech PCA and the Sausalito PCI PCA are not damaged and are correctly connected.
- Replace the PrintMech PCA ⇒ Page 464.
- If the System Error continues, replace the Sausalito PCI PCA ⇒ Page 444.

SE Code: 01.02:10 - ISS PCA Problem

Problem Description:

The ISS PCA has failed to respond.

Corrective Action:

- Switch the Power OFF from the back of the Printer and disconnect the Power cord. Reconnect the power cord and power On the Printer.
- Check the connections of the ISS PCAs (Upper and Lower) are correctly connected and not damaged.
- Check with another set of Ink Cartridges, to ensure the error is not with the Ink Cartridges.
- Replace the ISS PCAs (Upper and lower)⇒ Page 391.

SE Code: 02.01:10 - Problem with the Carriage PCA**Problem Description:**

The Carriage PCA has failed to respond.

Corrective Action:

- Switch the Power OFF from the back of the Printer and disconnect the Power cord. Reconnect the power cord and power On the Printer.
- Check that the Trailing Cable is not damaged.
- Check that the Trailing Cable is correctly connected to the Carriage PCA, Interconnect PCA and to the Sausalito PCI PCA.
- Replace the Carriage PCA ⇒ Page 402.
- Replace the Sausalito PCI PCA ⇒ Page 444.
- Replace the Interconnect PCA⇒ Page 435.

SE Code: 03:10 - Problem with the PSU**Problem Description:**

The Power Supply Unit (PSU) has failed.

Corrective Action:

- Switch the Power OFF from the back of the Printer and disconnect the Power cord. Reconnect the power cord and power On the Printer.
- Perform the Electronics Modules Test ⇒ Page 123.
- Replace the Power Supply Unit ⇒ Page 456.

SE Code: 05.1:10 - Problem with the CPU Fan**Problem Description:**

CPU Fan has stopped or burnt.

Corrective Action:

- Switch the Power OFF from the back of the Printer and disconnect the Power cord. Reconnect the power cord and power On the Printer.
- If the printer is unable to reboot, check the connections of the CPU Fan.
- Replace the CPU Fan ⇒ Page 452.
- If the printer is still unable to reboot, replace the Main PCA ⇒ Page 450.

SE Code: 05.3:10 - Main memory size failure

Problem Description:

This is a service test failure and will only be displayed while in the process of testing a part.

Corrective Action:

- Check that at least 256 megabytes of memory is installed in the Printer.
- Check that the Memory Module is installed correctly.
- Try installing the Memory Module in the other Memory slot and check if the system error is still displayed.
- If the System Error reappears, replace the Memory Module ⇒ Page 448.
- If the System Error does NOT reappear, then the original slot could be faulty. In this case, replace the Main PCA ⇒ Page 450

SE Code: 06.03 - NVM file has a bad CRC

Problem Description:

NVM file has a bad CRC.

Corrective Action:

- Switch the Power OFF from the back of the Printer and disconnect the Power cord. Reconnect the power cord and power On the Printer.
- If the System Error continues, replace the Hard Disk Drive ⇒ Page 452.

SE Code: 06:10 - Main NVM failure

Problem Description:

Main NVM failure - not detected, read/write failed or readback error.

Corrective Action:

- Switch the Power OFF from the back of the Printer and disconnect the Power cord. Reconnect the power cord and power On the Printer.
- If the System Error continues, replace the Hard Disk Drive ⇒ Page 452.

SE Code: 08:11 - Connection problem with the Front Panel

Problem Description:

Problem with communication between the Front Panel, the Formatter and the HDD.

Corrective Action:

- Switch the Power OFF from the back of the Printer and disconnect the Power cord. Reconnect the power cord and power On the Printer.
- If the printer emits one or multiple 'beeps' as the printer turns On, perform the procedure 'Using the buzzer at Power-up to Troubleshoot' ⇒ Page 43. Four beeps would indicate an error with the Front Panel:
 - Check that the Front Panel cable is not damaged and is correctly connected to the Front Panel and to the Interconnect PCA.
- Check that the Memory Module is installed correctly.

- Check that the cables between the Interconnect PCA and the Main PCA are not damaged and are correctly connected.
- Check that the cables between the Hard Disk Drive and the Power Supply Unit and the Main PCA are not damaged and are correctly connected.
- Check that the cable between the Power Supply Unit and the Main PCA is not damaged and is correctly connected.
- Check that the Printer has the latest Firmware version, if not, update the firmware to the latest version.
- Replace the Interconnect PCA ⇒ Page 435.
- Replace the Sausalito PCI PCA ⇒ Page 444.



NOTE: If the reset button is pressed and released quickly, the Front Panel does not have time to reset itself and the 08:11 system error is displayed. If after rebooting the problem will probably be solved. The correct operation of using the reset button on the Front Panel, is to press it and keep it pressed for about 3 seconds.

SE Code: 09.01:10 - TOMAS Error

Problem Description:

There is an error with the TOMAS reading. The measurements are unstable.

Corrective Action:

- Check that TOMAS is correctly connected ⇒ Page 32
- Replace TOMAS ⇒ Page 431.

SE Code: 11:10 - Connection problem with the Trailing cable

Problem Description:

Trailing Cable does not seem to be connected.

Corrective Action:

- Check that the Trailing Cable is not damaged.
- Check that the Trailing Cable is correctly connected to the Carriage PCA, Interconnect PCA and to the Sausalito PCI PCA.
- Replace the Sausalito PCI PCA ⇒ Page 444.
- Replace the Ink Supply Tubes and Trailing Cable ⇒ Page 380.
- Replace the Carriage PCA ⇒ Page 402.

SE Code: 14.01:00 - Temperature high on the Heat sink

Problem Description:

Over temperature in the Heatsink. At least one of the thermal switches attached to the Triac Heaters of the Heaters Control assembly has reached 90c.

Corrective Action:

- If the ambient environmental temperature is extremely warm and the Heaters Control Assembly cooling fan has failed, check the connection of the fan, and replace if required ⇒ Page 473.

- Replace the Heaters Control Assembly ⇒ Page 465.
- If the heater resistor value is too low, locate which of the heaters and replace:
 - Change the heaters in the Dryer Assembly ⇒ Page 498.
 - Change the heaters in the Curing module ⇒ Page 515

SE Code: 14.02:00 - Current too high on the Dryer Assembly

Problem Description:

Over current in Dryer assembly. The level of amps is over 18 amps, or the amount of current requested from the Dryer assembly is too high.

Corrective Action:

- Check if there is an AC voltage surge from the customers electricity supply.
- Replace the Dryer Assembly ⇒ Page 498.
- If the level of AC voltage is normal, replace the Heater Control Assembly ⇒ Page 465

SE Code: 14.03:00 - Current too high on the Curing Module

Problem Description:

Overcurrent in Curing Module. The level of amps is over 18 amps, or the amount of current requested from the curing Module is too high.

Corrective Action:

- Check if there is an AC voltage surge from the customers electrical supply.
- Replace the heaters in the Curing Module, replace ⇒ Page 525.
- If the level of AC voltage is normal, replace the Heater Control Assembly ⇒ Page 465.

SE Code: 14.04:00 - AC Voltage too high on the Dryer Assembly

Problem Description:

AC Voltage too high. The voltage value detected that is going to the dryer heater is higher than expected. The correct voltage is calculated by the firmware using the current measured by the Heaters Control PCA and the resistor values stored in the NVM.

Corrective Action:

- Check if the voltage of the customer's site is too high.
- Check the resistance values ⇒ page 54, if they are too low ⇒ page 54, replace the Dryer Module ⇒ Page 498.
- Replace the Heaters Control Assembly ⇒ Page 465 (60 inch.).

SE Code: 14.05:00 - AC Voltage too low on the Dryer Assembly

Problem Description:

AC Voltage too low. The voltage is calculated by the firmware using the current value measured by the Heaters control PCA and the resistor values stored in the NVM.

Corrective Action:

- Check if the voltage at the customer's site is not too low.

- Check the dryer resistor values, if they are too high, or there is an open circuit, replace the Dryer module ⇒ Page 498.
- Replace the Heater Control Assembly ⇒ Page 465 (60 inch).

SE Code: 14.06:00 - One or more heaters are not connected

Problem Description:

There is a communication failure between the Heaters Control Assembly and the Curing Module or Dryer Assembly.

Corrective Action:

- Check all the cables are correctly connected from the Heaters Control assembly to the Curing module and the Dryer Assembly around the left arc.
- Check that none of the cables are damaged, if they are replace them.
- Check the cables are connected between the Heaters Control Assembly PCA and the Sausalito PCA.

SE Code: 14.07:00 - Connection problem with Heaters Control assembly

Problem Description:

I2C Protocol not working. The firmware has detected that there is no communication to/from the Heaters Control Assembly and the Printmech PCA.

Corrective Action:

- Check all the cables are connected between the Heaters Control assembly and the PrintMech PCA, try disconnecting and reconnecting them.
- If there is no light on the 5v LED on the Heater Control PCA, (refer to ⇒ Page 49) this would indicate a lack of 5v to the Heaters Control assembly, check the cables from the PrintMech.
- Replace the Heaters Control assembly ⇒ Page 465 (60 inch.).
- Replace the PrintMech PCA ⇒ Page 482.

SE Code: 14.08:00 - No AC voltage in the Dryer Assembly

Problem Description:

The firmware has detected that there is no AC voltage in the Dryer Input connection.

Corrective Action:

- Check that the power cables are correctly inserted at the rear of the printer. Check to see if a fuse has blown on one of the electrical input cables (when the region has a fuse in the power cord).
- Check to see if the Residual Current Circuit Breaker (RCCD) has blown, reset it, if it blows again immediately (or often), this would indicate an error with the Dryer Assembly or the RCCD.
- Check the electrical supply from the customer's site.
- Check that the power cables are correctly inserted at the rear of the printer.
- Check to see if the Residual Current Circuit Breaker (RCCD) has blown, reset it, if it blows again immediately (or often), this would indicate an error with the Dryer Assembly or the RCCD.
- Check the connections of the cables from the Dryer input connection, RCCD, the filter and the Heater Control Assembly.

- Check to see if the fuses F1 and F2 have blown on the Heaters Control Assembly ⇒ page 53, if they have replace the Heater Control Assembly ⇒ Page 465.
- Check the 24 Volt LED on the PrintMech is on, see ⇒ Page 49, check the connections between the Heaters Control assembly and the PrintMech PCA, try disconnecting and reconnecting them.
- One of the following PCAs has failed and must be replaced:
 - Replace the Heater Control Assembly ⇒ Page 465.
 - Replace the PrintMech ⇒ Page 482.
 - Replace the Sausalito PCI PCA ⇒ Page 444.

SE Code: 14.09:00 - Heaters Control PCA is not ready

Problem Description:

Heaters Control PCA is not ready, +5v DC has not been detected in the PCA.

Corrective Action:

- Check all the cables are connected between the Heaters Control assembly and the Sausalito PCA, try disconnecting and reconnecting them.
- Check all the cables are connected between the Heaters Control assembly and the PrintMech PCA, try disconnecting and reconnecting them.
- There is an internal electrical problem with the Heaters Control assembly, replace the assembly ⇒ Page 465.
- Replace the Sausalito PCI PCA ⇒ Page 444.

SE Code: 14.10:00 - Open circuit on the Dryer Assembly

Problem Description:

A certain amount of power is applied to the Dryer Assembly and is then the flow of current is measured, if the flow of current is not as expected, the system error is displayed

Corrective Action:

- Check all the cables are connected in the Dryer Assembly, try disconnecting and reconnecting them.
- Check the power connection to the Heaters control assembly PCA (J10).
- Check the cable between the Dryer Input connection and the cable of the Dryer Residual Current Circuit Breaker (RCCD)
- Disconnect the power input to the Dryer Assembly located at the rear of the printer, and reconnect.
- Check to see if the Residual Current Circuit Breaker (RCCD) has blown, reset it, if it blows again immediately (or often), this would indicate an error with the Dryer Assembly or the RCCD.
- Check to see if there is a blown fuse in the Heater Control Assembly (F1 and F2)⇒ page 53.
- Replace the Heater Control Assembly ⇒ Page 465.
- Faulty resistor in the Dryer Assembly, replace the Dryer Assembly⇒ Page 498.

SE Code: 14.11:00 - Open circuit in the Curing Module

Problem Description:

Power is applied to the Curing module and then the current is measured, if the flow of current is not as expected, the system error is displayed

Corrective Action:

- Check all the cables are connected in the Curing Module, try disconnecting and reconnecting them.
- Check the power connection to the Heaters control assembly PCA (J9).
- Check the cable between the PSU and the cable of the Curing Residual Current Circuit Breaker (RCCD)
- Check to see if the Residual Current Circuit Breaker (RCCD) has blown, reset it, if it blows again immediately (or often), this would indicate an error with the Curing Assembly or the RCCD.
- Check to see if there is a blown fuse in the Heater Control Assembly (F1 and F2)⇒ page 53.
- Replace the Heater Control Assembly ⇒ Page 465.
- Faulty resistor in the Curing Module, replace the heaters in the Curing module ⇒ Page 515.

SE Code: 14.12:00 - Petisa Fan Fault

Problem Description:

The fan has failed in the Heaters Control Assembly (Petisa).

Corrective Action:

- Check the cables to the fan Assembly are all connected and there is no damage.
- Check to see if there is any obstruction or dirt in the fan that could stop it rotating.
- Replace the Heaters Control Assembly Fan ⇒ Page 473.
- Replace the Heaters Control Assembly⇒ Page 465.

SE Code: 14.13:00 - Current Leak in Drying Channel

Problem Description:

Current leak in the Dryer assembly. The electrical power is removed from the Dryer Assembly, if there is still a flow of current detected, the system error is displayed

Corrective Action:

- There is a current leak in the triac or relay control system, replace the Heaters Control assembly ⇒ Page 465 Note: If the Dryer Assembly has recently been replaced because of a faulty resistor, this fault can also damage the triac control system.

SE Code: 14.14:00 - Current leak in the Curing Module

Problem Description:

Current leak in the Curing Module. The electrical power is removed from the Curing Module, if there is still a flow of current detected, the system error is displayed

Corrective Action:

- There is a current leak in the triac control or relay system, replace the Heaters Control assembly ⇒ Page 465. Note: If the Curing module has recently been replaced because of a faulty resistor, this fault can also damage the triac control system.

SE Code: 14.15:00 - Generic failure with the Heaters Control Assembly**Problem Description:**

There is a failure with the Heaters Control assembly.

Corrective Action:

- Switch the Power OFF from the back of the Printer and disconnect the Power cord. Reconnect the power cord and power On the Printer.
- Check all the cables are connected in the Electronics module.
- Replace the Heaters Control assembly ⇒ Page 465 (60 inch.). Note: If the Curing module has recently been replaced because of a faulty resistor, this fault can also damage the triac control system.
- Replace the Sausalito PCI PCA ⇒ Page 444.
- Replace the PrintMech ⇒ Page 482.
- Replace the Main PCA Formatter ⇒ Page 450.
- Replace the internal cables of the Electronics Module.

SE Code: 14.16:00 - AC voltage too high on the Curing Module**Problem Description:**

AC Voltage too high. The voltage value detected that is going to the Curing module is higher than expected. The correct voltage is calculated by the firmware using the current measured by the Heaters Control PCA and the resistor values stored in the NVM.

Corrective Action:

- Check if the voltage of the customer's site is too high.
- Check the resistance values ⇒ page 54, if they are too low, replace the Curing Heaters ⇒ Page 515.
- Replace the Heaters Control Assembly ⇒ Page 465 (60 inch.).

SE Code: 14.17:00 - AC Voltage too low on the Curing Module**Problem Description:**

AC Voltage too low. The voltage is calculated by the firmware using the current value measured by the Heaters control PCA and the resistor values stored in the NVM

Corrective Action:

- Check if the voltage at the customer's site is not too low.
- Check the Curing resistor values, if they are too high, or there is an open circuit, replace the Curing module ⇒ Page 498.
- Replace the Heater Control Assembly ⇒ Page 465 (60 inch.).

SE Code: 15.01:00 Drying system warm up timed out

Problem Description:

Drying System unable to warm up in the pre-defined amount of time (45C for standby & normally 55C for printing).

Corrective Action:

- Check if the environmental ambient temperature is low. Check the surrounding temperature is within the printer's operating specifications; it should be higher than 15C for printer operation. If this is the case, increase the ambient temperature of the printer's location.
- Check if the input voltage is in the range of 198v to 205v, ensure the ambient temperature is higher than 20C for the correct functioning of the printer.
- Check if the substrate loaded on the printer is too transparent or reflective for the IR sensor to detect the surface temperature. Check this by loading another type of substrate.
- Check if the Dryer IR sensor is dirty and requires cleaning, use the cleaning procedures described in the User's Guide while observing all safety precautions while working in the area of the heaters.
- Check the power going to the IR sensor. A good indication is that the blue LED on the sensor's body will light if the sensor is pointing to an object warmer than 30C.
- Perform the IR sensor diagnostic check 8.3 Heating IR Sensor ⇒Page 169, to check the values being detected by the IR sensor. Replace the Dryer IR sensor if required ⇒Page 496.
- Check if the position of the IR sensor is correct, if it is pointing to a position other than the substrate this will cause an error.
- Check the input voltage is outside the range of specifications for printing, check the installation instructions.
- Replace the Heaters Control Assembly⇒ Page 465.
- If the power arrives to the heater, but the heater does not heat up, replace the heater assembly⇒Page 498.

SE Code: 15.02:00 - Drying system cool down time out

Problem Description:

Drying System unable to cool down in the pre-defined amount of time.

Corrective Action:

- Check there are no obstructions on any of the cooling fans: Dryer, Curing, Top Cover Fans, Rear Fans.
- Check all the fans are functioning correctly. check the cables of the fans are not damaged and are connected. Replace any fans if required: Top cover fans ⇒ Page 349. Rear Fans ⇒Page 351. Curing Fans ⇒Page 503.
- The environmental ambient temperature is too hot or is outside the operational specification of the printer. Make sure there are no external sources of heat, such as strong lights, direct sunlight, heaters etc.

SE Code: 15.03:00 - Drying system temperature too high

Problem Description:

Drying System has exceeded the upper temperature level.

Corrective Action:

- The cooling fans intake is blocked, check there are no obstructions on any of the cooling fans: Dryer, Curing, Top Cover Fans, Rear Fans.
- Check if the Dryer IR sensor is dirty and requires cleaning, use the cleaning procedures described in the User's Guide while observing all safety precautions while working in the area of the heaters.
- Check the power going to the IR sensor. A good indication is that the blue LED on the sensor's body will light if the sensor is pointing to an object warmer than 30C.
- Check the position of the IR sensor is correct, if it is pointing to a position other than the substrate this will cause an error.
- Perform the IR sensor diagnostic check 8.3 Heating IR Sensor ⇒Page 169, to check the values being detect by the IR sensor. Replace the Dryer IR sensor if required ⇒Page 496.

SE Code: 15.04:00 - Drying system temperature too low**Problem Description:**

Drying System has exceeded the lower temperature level (below 5C)

Corrective Action:

- Check if the environmental ambient temperature is low. Check the surrounding temperature is within the printer's operating specifications; it should be higher than 15C for printer operation. If this is the case, increase the ambient temperature of the printer's location.
- Check if the Dryer IR sensor is dirty and requires cleaning, use the cleaning procedures described in the User's Guide while observing all safety precautions while working in the area of the heaters.
- Check the power going to the IR sensor. A good indication is that the blue LED on the sensor's body will light if the sensor is pointing to an object warmer than 30c.
- Check the position of the IR sensor is correct, if it is pointing to a position other than the substrate this will cause an error.
- Perform the IR sensor check 1.8.1 Heating and Curing temp ⇒Page 195, to check the values being detected by the IR sensor. Replace the Dryer IR sensor if required ⇒Page 496.
- Replace the Heaters Control Assembly ⇒Page 465.

SE Code: 15.05:00 - Problem with the Drying System Temperature Sensor**Problem Description:**

Signal error detected with the Drying System Temperature Sensor.

Corrective Action:

- Check that none of the air intakes of any of the fans are blocked
- Check if the Dryer IR sensor is dirty and requires cleaning, use the cleaning procedures described in the User's Guide while observing all safety precautions while working in the area of the heaters.
- Check the power going to the IR sensor. A good indication is that the blue LED on the sensor's body will light if the sensor is pointing to an object warmer than 30c.
- Perform the IR sensor diagnostic check 8.3 Heating IR Sensor ⇒Page 169, to check the values being detected by the IR sensor. Replace the Dryer IR sensor if required ⇒Page 496.

SE Code: 15.06:00 - Temperature error detected

Problem Description:

There is a mismatch between the temperature detected by the Drying IR Sensor and the amount of electrical power the Drying System is receiving

Corrective Action:

- The ink density is too high, check the User's Manual for the recommended ink density levels.
- Check if the input voltage is in the range of 198v to 205v, ensure the ambient temperature is higher than 20C for the correct functioning of the printer.
- Check if the substrate loaded on the printer is too transparent or reflective for the IR sensor to detect the surface temperature. Check this by loading another type of substrate.
- Check that power is going to the IR Sensor, a good indication of this is the blue LED lights if the sensor is pointing to an object warmer than 30c
- Check if the Dryer IR sensor is dirty and requires cleaning, use the cleaning procedures described in the User's Guide while observing all safety precautions while working in the area of the heaters.
- Check the position of the IR sensor is correct, if it is pointing to a position other than the substrate this will cause an error.
- Perform the IR sensor check 1.8.1 Heating and Curing temp ⇒Page 195, to check the values being detected by the IR sensor. Replace the Dryer IR sensor if required ⇒Page 496.
- Replace the Heaters Control Assembly ⇒Page 465.
- If there is power going to the heater, but the heater does not come on, replace the heater ⇒Page 498.
- Check the voltage supplied to the Printer is inside the Printers functional specifications.
- Check the quality of the AC line going into the printer.

SE Code: 15.08:00 - Dryer fans not connected

Problem Description:

The array of Drying System fan(s) is not connected. The firmware has detected there is no feedback from the fans.

Corrective Action:

- Perform the service test 2.4 to check that all the fans are working ⇒Page 129.
- Check the cables from the Dryer Fans to the Printmech are not damaged and are connected.
- Replace the PrintMech ⇒ Page 482.

SE Code: 15.09:00 - Drying fans failure

Problem Description:

One or more Drying fans have failed. The firmware has detected there is no feedback from the fans.

Corrective Action:

- Perform the service test 2.4 ⇒Page 129 to confirm that one or more of the fans is not working.
- If none of the fans are working, this would indicate a failure with the PrintMech, or the cables from the PrintMech:

- Check the cables from the Printmech.
- Replace the Printmech PCA ⇒Page 482.
- If at least one of the fans is working, check if the failed fans are connected, they are replace the failed fans ⇒Page 351.

SE Code: 15.10:00 - Drying Assembly resistors incorrect

Problem Description:

The firmware measures the current through the Burst resistor and the steady resistor, and it checks that one is greater than the other. If the measurements detected are not as expected this could indicate that the heaters have been swapped in error.

Corrective Action:

- Replace the Dryer Assembly ⇒ Page 498.

SE Code: 16.01:00 - Curing Module warm up time out

Problem Description:

Curing System unable to warm up in the pre-defined amount of time: 9 minutes (45C for standby & normally 95C for printing).

Corrective Action:

- Check if the environmental ambient temperature is too low. Check the surrounding temperature is within the printer's operating specifications; it should be higher than 15C for printer operation. If this is the case, increase the ambient temperature of the printer's location.
- Check if the input voltage is in the range of 198v to 205v, ensure the ambient temperature is higher than 20C for the functioning of the printer.
- Check if the substrate loaded on the printer is too transparent or reflective for the Curing IR sensor to detect the surface temperature. Check this by loading another type of substrate.
- Check if the Curing IR sensor is dirty and requires cleaning, use the cleaning procedures described in the User's Guide while observing all safety precautions while working in the area of the heaters.
- Check for an obstacle blocking the IR sensor's view. Ensure the IR sensor is correctly installed on the printer, with no interference in the IR path
- Check the power going to the Curing IR sensor. A good indication is that the blue LED on the sensor's body will light if the sensor is pointing to an object warmer than 30c.
- Check the position of the Curing IR sensor is correct, if it is pointing to a position other than the substrate this will cause an error.
- Perform the IR sensor diagnostic check 8.4 Curing IR sensor ⇒Page 170, to check the values being detected by the IR sensor. Replace the Curing IR sensor if required ⇒Page 510.
- Check if the input voltage is inside the range of specifications for printing, check the installation instructions.
- Replace the Heaters Control Assembly ⇒ Page 465.
- If the power arrives to the heater, but the heater does not heat up, replace the heater's in the Curing Assembly⇒Page 498.

SE Code: 16.02:00 - Curing system cool down time out

Problem Description:

Curing System unable to cool down in the pre-defined amount of time.

Corrective Action:

- Check there are no obstructions on any of the cooling fans: Curing, Top Cover Fans, Rear Fans.
- Check the cables of the fans are not damaged and are connected. Replace any fans if required: Top cover fans ⇒ Page 349. Rear Fans ⇒Page 351 . Curing Fans ⇒Page 503.
- The environmental ambient temperature is too hot or is outside the operational specification of the printer. Make sure there are no external sources of heat, such as strong lights, direct sunlight, heaters etc.

SE Code: 16.03:00 - Curing system temperature too high

Problem Description:

Curing System has exceeded the upper temperature level (150C).

Corrective Action:

- Check there are no obstructions on any of the cooling fans: Curing, Top Cover Fans, Rear Fans.
- Check the Curing IR Sensor Fan is turning and is correctly installed with the fan in the correct orientation.
 - Check the cables are connected and not damaged.
 - Replace the Curing IR Sensor & Fan ⇒Page 510.
 - Replace the Printmech ⇒Page 482.
- The Curing IR sensor is dirty and requires cleaning, use the cleaning procedures described in the User's Guide while observing all safety precautions while working in the area of the heaters.
- Check the power going to the Curing IR sensor. A good indication is that the blue LED on the sensor's body will light if the sensor is pointing to an object warmer than 30C.
- Check the position of the Curing IR sensor is correct, if it is pointing to a position other than the substrate this will cause an error.
- Perform the Curing IR sensor diagnostic check "8.4 Curing IR sensor" ⇒Page 170, to check the values being detected by the Curing IR sensor. Replace the Curing IR sensor if required ⇒Page 510.
- Ensure there are no other addition external sources of heat, such as strong sunlight, powerful lights or heaters.

SE Code: 16.04:00 - Curing system temperature too low (below 5C)

Problem Description:

Curing System has exceeded the lower temperature level.

Corrective Action:

- Check if the environmental ambient temperature is low. Check the surrounding temperature is within the printer's operating specifications; it should be higher than 15C for correct printer operation. If this is the case, increase the ambient temperature of the printer's location.

- Check if the Curing IR Temperature sensor is dirty and requires cleaning, use the cleaning procedures described in the User's Guide while observing all safety precautions while working in the area of the heaters.
- Check if there is an obstacle blocking the view of the Curing IR Sensor. Check that it is correctly installed with no interference in the IR path.
- Check the power going to the Curing IR temperature sensor. A good indication is that the blue LED on the sensor's body will light if the sensor is pointing to an object warmer than 30C.
- Check the position of the Curing IR temperature sensor is correct, if it is pointing to a position other than the substrate this will cause an error.
- Perform the IR sensor check diagnostic "8.4 Curing IR sensor" ⇒Page 170, to check the values being detected by the IR sensor. Replace the Curing IR sensor if required ⇒Page 510.
- Replace the Heaters Control Assembly ⇒Page 465.

SE Code: 16.05:00 - Problem with the Curing System Temperature Sensor

Problem Description:

Signal error detected with the Curing System Temperature Sensor.

Corrective Action:

- Check the Curing IR Sensor Fan is turning and is correctly installed with the fan in the correct orientation.
 - Check the cables are connected and not damaged.
 - Replace the Curing IR Sensor & Fan ⇒Page 510.
 - Replace the Printmech ⇒Page 482.
- check if the Curing IR sensor is dirty and requires cleaning, use the cleaning procedures described in the User's Guide while observing all safety precautions while working in the area of the heaters.
- Check the power going to the IR sensor. A good indication is that the blue LED on the sensor's body will light if the sensor is pointing to an object warmer than 30c.
- Perform the IR sensor diagnostic check "8.4 Curing IR sensor" ⇒Page 170, to check the values being detected by the IR sensor. Replace the Curing IR sensor if required ⇒Page 503.

SE Code: 16.06:00 - Temperature error detected

Problem Description:

There is a mismatch between the temperature detected by the Curing IR Sensor and the amount of electrical power the Curing System is receiving

Corrective Action:

- The ink density is too high, check the User's Manual for the recommended ink density levels.
- The input voltage is in the range of 198v to 205v, ensure the ambient temperature is higher than 20C for the functioning of the printer.
- Check if there is an obstacle blocking the view of the Curing IR Sensor. Check that it is correctly installed with no interference in the IR path.
- Check if the substrate loaded on the printer is too transparent or reflective for the IR sensor to detected the surface temperature. Check this by loading another type of substrate.

- Check that power is going to the IR Sensor, a good indication of this is the blue LED lights if the sensor is pointing to an object warmer than 30C
- Check if the Curing IR sensor is dirty and requires cleaning, use the cleaning procedures described in the User's Guide while observing all safety precautions while working in the area of the heaters.
- Check the position of the IR sensor is correct, if it is pointing to a position other than the substrate this will cause an error.
- Perform the IR sensor diagnostic check "8.4 Curing IR sensor" ⇒Page 170, to check the values being detected by the IR sensor. Replace the Curing IR sensor if required ⇒Page 510.
- Replace the Heaters Control Assembly ⇒Page 465.
- If there is power going to the Curing heater, but the heater does not come on, replace the Curing Heaters ⇒Page 515.
- Check the quality of the AC line going into the printer is within operational specification.

SE Code: 16.08:00 - Curing System fans not connected

Problem Description:

The array of Curing System fan(s) is not connected.

Corrective Action:

- To confirm that none of the fans are working perform the service test 2.4 ⇒Page 129.
- Check the cables from the Curing Fans to the Printmech are not damaged and are connected.
- Replace the PrintMech ⇒ Page 482.

SE Code: 16.09:00 - Curing System fans failure

Problem Description:

The array of Curing System fan is not connected or has failed.

Corrective Action:

- Perform the service test 2.4 ⇒Page 129 to confirm that one or more of the fans is not working.
- If none of the fans are working, this would indicate a failure with the PrintMech, or the cables from the PrintMech:
 - Check the cables from the Printmech.
 - If all the cables from the Printmech to the fans are connected, replace the Printmech ⇒Page 482.
- If at least one of the fans is working, check if the failed fans are connected, if they are replace the failed fan (Top Cover Fans ⇒Page 349 or Rear Cover Fans ⇒Page 351, Curing Fans ⇒Page 503).

SE Code: 16.10:00 - Curing Assembly resistors incorrect

Problem Description:

The firmware measures the current through the Burst resistor and the steady resistor, and it checks that one is greater than the other. If the measurements detected are not as expected this could indicate that the heaters have been swapped in error.

Corrective Action:

- Replace the Curing Heaters ⇒ Page 515.

SE Code: 21.02:10 - Problem with the Web Wipe motor

Problem Description:

Web Wipe Motor servo shut down.

Corrective Action:

- Switch the Power OFF from the back of the Printer, manually pull the Printhead Maintenance Cartridge to the front position and power On the Printer.
- Switch the Power OFF from the back of the Printer and remove the Printhead Maintenance Cartridge, and switch on, if the error is cleared, replace the Printhead Maintenance Cartridge
- Replace the Web Wipe Motor⇒ Page 368.

SE Code: 21.03:10 - Electrical problem in the Web Wipe Motor

Problem Description:

Error detected in the area of the Web Wipe Assembly (Rack engage motor electrical)

Corrective Action:

- Switch the Power OFF from the back of the Printer, manually pull the Printhead Maintenance Cartridge to the position and power On the Printer.
- Switch the Power OFF from the back of the Printer and remove the Printhead Maintenance Cartridge, and switch on, if the error is cleared, replace the Printhead Maintenance Cartridge
- Replace the Web Wipe Motor⇒ Page 368.
- Replace the PrintMech ⇒Page 482.

SE Code: 21.05:03 - Web Wipe Assembly Drifting

Problem Description:

Error detected in the area of the Web Wipe Assembly (Rack engage drifting).

Corrective Action:

- Switch the Power OFF from the back of the Printer, manually pull the Printhead Maintenance Cartridge to the front position and power On the Printer.
- Switch the Power OFF from the back of the Printer and remove the Printhead Maintenance Cartridge, and switch on, if the error is cleared, replace the Printhead Maintenance Cartridge
- Replace the Web Wipe Motor⇒ Page 368.

SE Code: 21:10 - Problem in the area of the Service Station

Problem Description:

Fault has been detect in the area of the Service Station.

Corrective Action:

Try the following:

- Switch the Power OFF from the back of the Printer and disconnect the Power cord. Reconnect the power cord and power On the Printer.

- Make sure that the Service Station path is clear. Remove any visible obstacles (e.g. foam from the printer's packaging, screws, plastic parts, etc...) restricting the movement of the Service Station.
- If the System Error continues, replace the Service Station ⇒ Page 364.

SE Code: 21:13 - Problem in the Service Station

Problem Description:

Problem with the Service Station.

Corrective Action:

- Switch the Power OFF from the back of the Printer and disconnect the Power cord. Reconnect the power cord and power On the Printer.
- Make sure that the Service Station path is clear. Remove any visible obstacles (e.g. screws, plastic parts, etc...) restricting the movement of the Service Station.
- Switch the Power OFF from the back of the Printer, remove the Printhead Maintenance Cartridge, and switch on.
- If the System Error continues, replace the Service Station ⇒ Page 364.

SE Code: 23:10 - Problem with pressurization in the APS

Problem Description:

The APS has received a request to depressurize, but the system does not depressurize in under a specific time (120 seconds).

Corrective Action:

- Check that the relief valve cable is not damaged and is correctly connected to the PrintMech PCA.
- Check the continuity in the cable of the relief valve.
- Try tapping the relief valve of the APS with a screw driver to release the mechanism.
- Check the air tubes connected to the relief valve are not bent or twisted and that air can flow in the tubes.
- To check if the issue has been solved perform the APS service test ⇒ Page 146.
- If the test fails replace the APS ⇒ Page 395.
- Replace the PrintMech PCA ⇒ Page 464.
- Replace the Sausalito PCI PCA ⇒ Page 444.

SE Code: 24:03 - Ink Seup Failure

Problem Description:

Ink Setup failure. The purge process has failed or has been canceled by the customer.

Corrective Action:

- Switch the Power OFF from the back of the Printer and disconnect the Power cord. Reconnect the power cord and power On the Printer.
- Try purging the Ink Supply Tubes again when the Printer has been rebooted. If the printer does not automatically go into the purge process, use the service test procedure "1.4.1 Purge tubes" ⇒ Page 190.

- Install new Ink Cartridges in to the Printer and try purging the Printer again. If the printer does not automatically go into the purge process, use the service test procedure “1.4.1 Purge tubes” ⇒ Page 190.

SE Code: 24:10 - Ink Cartridge Broken Bag

Problem Description:

A broken bag has been detected in one of the Ink Cartridges. This error must be solved and the printer checked and cleared of this error code before the printer can resume printing

Corrective Action:

- The front panel message will indicate which Ink Cartridge has a broken bag. Remove the Ink Cartridge and check for any ink leaking from the cartridge. In some extreme cases:
 - Ink can leak from the damaged Ink Cartridge and contaminate the pressurized air system
 - or
 - Air can get inside the Ink System causing bubbles in the Ink Tubes which can damage the Print-heads.
- For this issue there is a specific menu selection to solve and recover the printer from the broken bag error. Perform the “Bag Broken Recovery” Diagnostic procedure (⇒ Page 148).
- If the Lower ISS PCS has been damaged by ink this must be replaced if it cannot be repaired ⇒ Page 391.

SE Code: 24.02:00 - Top Cover Fans array is not connected

Problem Description:

The firmware has detected that there is no connection to the array of Top Covers Fans

Corrective Action:

- Perform the service test 2.4 ⇒Page 129 to confirm that all of the Top cover Fans are not working.
- Check the Top Cover Fans cable by the left arch, is connected to the PrintMech, at both ends, and that none are damaged.
- If all the cables from the Printmech to the fans are connected, replace the Printmech ⇒Page 482.

SE Code: 24.03:00 - One of the Top Cover Fans not connected

Problem Description:

The firmware has detected that one or more of the Top Covers Fans is not working.

Corrective Action:

- Perform the service test 2.4 ⇒Page 129 to confirm that one or more of the Top cover Fans is not working.
- If none of the fans are working, this would indicate a failure with the PrintMech, or the cables from the PrintMech:
 - Check the cables from the Printmech.
 - If all the cables from the Printmech to the fans are connected, replace the Printmech ⇒Page 482.
- If at least one of the fans is working, check if the failed fans are connected to the array, if it is connected replace the failed fan (Top Cover Fans ⇒Page 349).

- If the error is not cleared, check all the cables from the failed fan to the PrintMech.

SE Code: 26.00:10 - Contact failure with Magenta Ink Cartridge

Problem Description:

Bad contact detected in ISS slot 0 floater.

Corrective Action:

- Remove the Magenta Ink Cartridge and reinstall it in to the Printer.
- Check the Ink supply tube to this Ink Cartridge has not been forced laterally causing a misalignment of the floater (Ink supply connector).
- Check the floater spring is functioning correctly.
- Replace the Magenta Ink Cartridge.
- Check that the ISS to Cartridge cable (Magenta Ink Cartridge) is not damaged and is correctly connected to the Ink Supply Tubes PCA.
- Replace the ISS to Cartridge cable (Magenta Ink Cartridge) ⇒ Page 385.
- Replace the ISS PCA ⇒ Page 391
- Replace the Ink Supply Tubes and Trailing Cable ⇒ Page 380.

SE Code: 26.01:10 - Contact failure with Yellow Ink Cartridge

Problem Description:

Bad contact detected in ISS slot 1 floater.

Corrective Action:

- Remove the Yellow Ink Cartridge and reinstall it in to the Printer.
- Check the Ink supply tube to this Ink Cartridge has not been forced laterally causing a misalignment of the floater (Ink supply connector).
- Check the floater spring is functioning correctly.
- Replace the Yellow Ink Cartridge.
- Check that the ISS to Cartridge cable (Yellow Ink Cartridge) is not damaged and is correctly connected to the Ink Supply Tubes PCA.
- Replace the ISS to Cartridge cable (Yellow Ink Cartridge) ⇒ Page 385.
- Replace the ISS PCA ⇒ Page 391
- Replace the Ink Supply Tubes and Trailing Cable ⇒ Page 380.

SE Code: 26.02:10 - Contact failure with Black Ink Cartridge

Problem Description:

Bad contact detected in ISS slot 2 floater.

Corrective Action:

- Remove the Black Ink Cartridge and reinstall it in to the Printer.
- Check the Ink supply tube to this Ink Cartridge has not been forced laterally causing a misalignment of the floater (Ink supply connector).

- Check the floater spring is functioning correctly.
- Replace the Black Ink Cartridge.
- Check that the ISS to Cartridge cable (Black Ink Cartridge) is not damaged and is correctly connected to the Ink Supply Tubes PCA.
- Replace the ISS to Cartridge cable (Black Ink Cartridge) ⇒ Page 385.
- Replace the ISS PCA ⇒ Page 391
- Replace the Ink Supply Tubes and Trailing Cable ⇒ Page 380.

SE Code: 26.03:10 - Contact failure with Cyan Ink Cartridge

Problem Description:

Bad contact detected in ISS slot 3 floater.

Corrective Action:

- Remove the Cyan Ink Cartridge and reinstall it in to the Printer.
- Check the Ink supply tube to this Ink Cartridge has not been forced laterally causing a misalignment of the floater (Ink supply connector).
- Check the floater spring is functioning correctly.
- Replace the Cyan Ink Cartridge.
- Check that the ISS to Cartridge cable (Cyan Ink Cartridge) is not damaged and is correctly connected to the Ink Supply Tubes PCA.
- Replace the ISS to Cartridge cable (Cyan Ink Cartridge) ⇒ Page 385.
- Replace the ISS PCA ⇒ Page 391
- Replace the Ink Supply Tubes and Trailing Cable ⇒ Page 380.

SE Code: 26.04:10 - Contact failure with Light Magenta Ink Cartridge

Problem Description:

Bad contact detected in ISS slot 4 floater.

Corrective Action:

- Remove the Light Magenta Ink Cartridge and reinstall it in to the Printer.
- Check the Ink supply tube to this Ink Cartridge has not been forced laterally causing a misalignment of the floater (Ink supply connector).
- Check the floater spring is functioning correctly.
- Replace the Light Magenta Ink Cartridge.
- Check that the ISS to Cartridge cable (Light Magenta Ink Cartridge) is not damaged and is correctly connected to the Ink Supply Tubes PCA.
- Replace the ISS to Cartridge cable (Light Magenta Ink Cartridge) ⇒ Page 385.
- Replace the ISS PCA ⇒ Page 391
- Replace the Ink Supply Tubes and Trailing Cable ⇒ Page 380.

SE Code: 26.05:10 - Contact failure with Light Cyan Ink Cartridge

Problem Description:

Bad contact detected in ISS slot 7 floater.

Corrective Action:

- Remove the Light Cyan Ink Cartridge and reinstall it in to the Printer.
- Check the Ink supply tube to this Ink Cartridge has not been forced laterally causing a misalignment of the floater (Ink supply connector).
- Check the floater spring is functioning correctly.
- Replace the Light Cyan Ink Cartridge.
- Check that the ISS to Cartridge cable (Light Cyan Ink Cartridge) is not damaged and is correctly connected to the Ink Supply Tubes PCA.
- Replace the ISS to Cartridge cable (Light Cyan Ink Cartridge) ⇒ Page 385.
- Replace the ISS PCA ⇒ Page 391
- Replace the Ink Supply Tubes and Trailing Cable ⇒ Page 380.

SE Code: 26:14 - An incorrect Ink Cartridge has been detected

Problem Description:

A wrong Ink Cartridge has been detected.

Corrective Action:

- Remove the Ink Cartridges and check that they are the correct ones for this Printer.
- Check that the Printer has the latest Firmware version, if not, update the firmware to the latest version.
- Replace the Ink Cartridges.

SE Code: 27:14 - An incorrect Printhead has been detected

Problem Description:

An incorrect Printhead has been detected.

Corrective Action:

- Remove the Printheads and check that they are the correct ones for this Printer.
- Check that the Printer has the latest Firmware version, if not, update the firmware to the latest version.
- Replace the Printheads.

SE Code: 29:02 - Printhead Cleaning Cartridge almost finished

Problem Description:

The Printhead Cleaning Cartridge absorber is almost finished. It will have to be replaced soon.

Corrective Action:

- Replace the Printhead Cleaning Cartridge.

- If the message continues even though the Printhead Cleaning Cartridge has been replaced, Check that the Printer has the latest Firmware version, if not, update the firmware to the latest version.
- If the new Printhead Cleaning Cartridge is not detected, reset the life counter of the part manually ⇒ Page 199.

SE Code: 32:01.01 - The substrate printed on is too small

Problem Description:

This system error occurs when there is a small amount of paper printed (less than 79 inches (200cm) long).

Corrective Action:

- Check there is no obstacle between the Take Up Reel optical sensors.
- Check the paper is attached to the Take Up Reel spindle.
- Check the Take Up Reel switch is in the correct position.
- If needed, use the Take Up Reel arrow keys to wind paper before resume printing.
- To resume printing, press OK.

SE Code: 32:01.02 - Problem with the Take Up Reel

Problem Description:

This system error happens when there is a small amount of paper printed (less than 70 inches long), and the Take Up Reel sensor detects that the loop shaper is (incorrectly) at the bottom of its path, even though the spindle motor has been rotating for more that 3 seconds.

The most probable cause of this error is the user has forgotten to set the switch direction or tape the paper to the spindle core, when the paper reaches the floor and blocks the Take Up Reel IR sensors.

Corrective action

- Check that there is no interference around the Take Up Reel optical sensors.
- Check the paper is attached to the Take Up Reel spindle.
- Check the Take Up Reel switch is in the correct position.
- Check there is no obstacle between the Take Up Reel optical sensors
- If required, use the Take Up Reel arrow keys to wind paper before resuming the print.
- When the jam is cleared, printing is resumed. Press the Ok key to clear the Warning message.

SE Code: 32:01 - Take Up Reel disconnected

Problem Description:

There is a cable connection problem with the Take Up Reel.

Corrective Action:

- If you want to keep using the Take Up Reel, you must turn off the printer and check all Take Up Reel cables are connected again (Sensors cables, printer cable).
- If not, manually unload the paper from the Take Up Reel. Remember to cut the paper before.

SE Code: 32:02 - Take Up Reel disconnected at initialization

Problem Description

This message is shown during initialization of the printer and indicates a warning that the Take Up Reel has been disconnected while the printer was off. This error is also shown if the user tries to enable the Take Up Reel but it is not connected to the Printer.

Corrective action:

Connect the Take Up Reel to the Printer and press Ok to continue.

SE Code: 41:03 - Limited electrical voltage at the Media Axis motor

Problem Description:

Electrical current limit in paper motor.

Corrective Action:

- Switch the Power OFF from the back of the Printer and disconnect the Power cord. Reconnect the power cord and power On the Printer.
- Open the Window and check for any visible obstacles restricting the movement of the Drive Roller. If there is a wrinkled mass of media inside the paper path, lift the Pinchwheels (using the Media Lever) and clear the obstruction.
- Replace the Media-Axis Motor ⇒ Page 422.
- If the System Error continues, replace the PrintMech PCA ⇒ Page 464.

SE Code: 41:10 - Electrical fault at the Media Axis motor

Problem Description:

Electrical fault in Media Axis motor.

Corrective Action:

- Switch the Power OFF from the back of the Printer and disconnect the Power cord. Reconnect the power cord and power On the Printer.
- Check that the Media-Axis Motor cable is not damaged and is correctly connected to the PrintMech PCA.
- Replace the Media-Axis Motor ⇒ Page 422.
- If the System Error continues, replace the PrintMech PCA ⇒ Page 464

SE Code: 42:03 - Problem with the Scan Axis Motor

Problem Description:

Electrical current limit in Scan Axis motor.

Corrective Action:

- Switch the Power OFF from the back of the Printer and disconnect the Power cord. Reconnect the power cord and power On the Printer.
- Open the Window and check for any visible obstacles restricting the movement of the Carriage Assembly. If there is a wrinkled mass of media blocking the Carriage Assembly, then clear the obstruction.

- Perform the Scan Axis Service Test ⇒ Page 157.
- Replace the Scan Axis Motor ⇒ Page 419.
- If the System Error continues, replace the PrintMech PCA ⇒ Page 464.

SE Code: 42:10 - Electrical fault in the Scan Axis area

Problem Description:

Electrical fault in Carriage Motor or starting the Scan Axis or Homing Scan Axis.

Corrective Action:

- Switch the Power OFF from the back of the Printer and disconnect the Power cord. Reconnect the power cord and power On the Printer.
- Perform the Scan Axis Service Test ⇒ Page 157.
- Check that the Scan Axis Motor cable is not damaged and is correctly connected to the PrintMech PCA.
- Replace the Scan Axis Motor ⇒ Page 419.
- If the System Error continues, replace the PrintMech PCA ⇒ Page 464

SE Code: 43:10 - Problem with the Vacuum Fan

Problem Description:

Vacuum Fan has failed.

Corrective Action:

- Switch the Power OFF from the back of the Printer and disconnect the Power cord. Reconnect the power cord and power On the Printer.
- Perform the Vacuum Fan service test ⇒ Page 142.
- Check that the Vacuum Fan cables are not damaged and are correctly connected to the Interconnect PCA.
- Also check that the cables between the Interconnect PCA and the PrintMech PCA are not damaged and are correctly connected.
- Replace the Interconnect PCA ⇒ Page 435.
- Replace the Vacuum Fan ⇒ Page 370.
- If the System Error continues, replace the PrintMech PCA ⇒ Page 464

SE Code: 44:10 - There is a problem with the Aerosol Fan

Problem Description:

The Aerosol Fan has failed.

Corrective Action:

- Switch the Power OFF from the back of the Printer and disconnect the Power cord. Reconnect the power cord and power On the Printer.
- Check that the Aerosol Fan cable is not damaged and is correctly connected to the Interconnect PCA.
- Replace the Aerosol Fan ⇒ Page 364.

- If the System Error continues, replace the Interconnect PCA ⇒ Page 435.

SE Code: 44:11 - Connection problem with the Aerosol Fan

Problem Description:

Aerosol Fan not connected.

Corrective Action:

- Check that the Aerosol Fan cable is not damaged and is correctly connected to the Interconnect PCA.
- Replace the Aerosol Fan ⇒ Page 364.

SE Code: 45.01:00 - Rewinder Servo Shutdown

Problem Description:

Problem with the Rewinder servo

Corrective Action:

- Check the spindle is correctly inserted into the Printer.
- Load the substrate again making sure that the media is straight and that a 'bubble' is not formed on the media path. Do not rewind manual the media when the printer is checking the roll.
- Check that the Spindle is not damaged and the gear at the end the spindle is correctly attached.
- Perform 3.1 Rewinder Motor service test ⇒page 133.
- Check the Rewinder motor cable is not damaged and is correctly connected.
- Replace the Right Roll Housing assembly ⇒ Page 579.
- Replace the Rewinder Motor ⇒ Page 361.

SE Code: 45.02:10 - Rewinder inverse polarity

Problem Description:

Rewinder inverse polarity. This message is only displayed when the printer is initializing

Corrective Action:

- Swap over the power cables of the Rewinder motor.

SE Code: 45.03:00 - Rewinder driver system fault

Problem Description:

There is a system fault with the Rewinder driver.

Corrective Action:

- Switch the Power OFF from the back of the Printer and disconnect the Power cord. Reconnect the power cord and power On the Printer.
- Check the Rewinder motor cables are not damaged and are correctly connected to the PrintMech PCA.
- Replace the Rewinder Motor ⇒ Page 361.
- Replace the PrintMech PCA ⇒ Page 482.

SE Code: 46:03 - Primer Servo shutdown

Problem Description:

There is a problem with the servo of the Primer.

Corrective Action:

- Switch the Power OFF from the back of the Printer and disconnect the Power cord. Reconnect the power cord and power On the Printer.
- Check to make sure there is not obstruction in the Primer mechanism.
- Replace the Primer Assembly ⇒ Page 355.
- Replace the PrintMech PCA ⇒ Page 464.
- Replace the Interconnect PCA ⇒ Page 435.

SE Code: 46:10 - Electrical fault in the Primer motor

Problem Description:

Electrical fault in Primer motor.

Corrective Action:

- Switch the Power OFF from the back of the Printer and disconnect the Power cord. Reconnect the power cord and power On the Printer.
- Check to make sure there is not obstruction in the Primer mechanism.
- Replace the Primer Assembly ⇒ Page 355.
- Replace the PrintMech PCA ⇒ Page 464.
- Replace the Interconnect PCA ⇒ Page 435

SE Code: 46:13 - Primer distance failed

Problem Description:

Primer test distance failed.

Corrective Action:

- Check that the Primer arm is not damaged and there are no obstructions in the way.
- Switch the Power OFF from the back of the Printer and disconnect the Power cord. Reconnect the power cord and power On the Printer.
- Replace the Primer Assembly ⇒ Page 355.

SE Code: 50:01 - OMAS Navigation failure

Problem Description:

OMAS Navigation failure.

Corrective Action:

Before preceding with corrective action for this error, it must be noted that some substrates cannot be detected by the OMAS. If the substrate has a high plastic content, is very reflective or is very smooth the OMAS will not detect it. In this case, the OMAS sensor must be disabled if the customer wants to carry on using the same media. To disable/enable the OMAS ⇒Page 189. It can also be disabled from the RIP.

- Switch the Power OFF from the back of the Printer and disconnect the Power cord. Reconnect the power cord and power On the Printer.
- Clean the OMAS window ⇒Page 602.
- Perform the OMAS check service test ⇒Page 189.
- Replace the OMAS⇒ Page 424.

SE Code: 50:03 - Internal electrical connection problem

Problem Description:

FW error in DSP or Engine code or link is broken between PCAs.

Corrective Action:

- There is a tendency for this system error to being displayed because of cables becoming disconnected. Check all relevant cables are correctly connected, especially the cables from the OMAS Controller and the Main PCA and the Sausalito PCA.
- Switch the Power OFF from the back of the Printer and disconnect the Power cord. Reconnect the power cord and power On the Printer.
- Check that the Printer has the latest Firmware version, if not, update the firmware to the latest version.
- Replace the OMAS Controller Card ⇒ Page 437
- Replace the OMAS Module ⇒ Page 424

SE Code: 50.01:10 - Connection problem with OMAS

Problem Description:

Error with the Optical Media Advance Sensor (OMAS) component or with the cable between sensor and the PCA.

Corrective Action:

- Switch the Power OFF from the back of the Printer and disconnect the Power cord. Reconnect the power cord and power On the Printer.
- Check that the Printer has the latest firmware version, if not, update the firmware to the latest version.
- Check that the OMAS Module cable is not damaged and is correctly connected to the OMAS Controller PCA.
- Replace the OMAS Controller Card ⇒ Page 437
- Replace the OMAS Module ⇒ Page 424.

SE Code: 50.01:11 - Error with Media Advance Sensor or with cable

Problem Description:

Error with the CAN cable of the CAN driver.

Corrective Action:

- Check the cable is not damaged and is correctly connected between the Sausalito and the OMAS Controller Board.
- Replace the OMAS controller PCA

- Replace the Sausalito PCA ⇒ Page 444
- Replace the cable between the Sausalito and the OMAS Controller Board.

SE Code: 50:11 - Media navigation problem

Problem Description:

Navigation problems, caused by a mis-positioned sensor, DOF or skew issue.

Corrective Action:

- Switch the Power OFF from the back of the Printer and disconnect the Power cord. Reconnect the power cord and power On the Printer.
- Check that the Printer has the latest Firmware version, if not, update the firmware to the latest version.
- Check that the OMAS Module cable is not damaged and is correctly connected to the OMAS Controller PCA.
- Replace the OMAS Controller Card ⇒ Page 437
- Replace the OMAS Module ⇒ Page 424

SE Code: 50:14 - Firmware version mis-match

Problem Description:

FW version mismatch between the controller fw and the version of the file in the Engine disk.

Corrective Action:

- Switch the Power OFF from the back of the Printer and disconnect the Power cord. Reconnect the power cord and power On the Printer.
- Check that the Printer has the latest Firmware version, if not, update the firmware to the latest version.
- Replace the OMAS Controller Card ⇒ Page 437

SE Code: 50.02:10 - Problem with OMAS Controller PCA

Problem Description:

Error with the media advance sensor controller board.

Corrective Action:

- Switch the Power OFF from the back of the Printer and disconnect the Power cord. Reconnect the power cord and power On the Printer.
- Check that the Printer has the latest Firmware version, if not, update the firmware to the latest version.
- Check that the CAN cable and the Encoder Cable are correctly connected to the OMAS PCA and the Sausalito PCA.
- Check the connection between the OMAS PCA and the Sausalito PCA (the Sausalito is the card connected just behind the OMAS PCA).
- Check that the OMAS Module cable is not damaged and is correctly connected to the OMAS Controller PCA.
- Replace the OMAS Controller Card ⇒ Page 437.

SE Code: 51:10 - An error has been detected with the Window Lock Sensor

Problem Description:

Error detected with the sensor on the Window.

Corrective Action:

- Check that the Window Sensor cable is not damaged and is correctly connected to the Interconnect PCA.
- Check the Window sensor locks are activating the Window Lock Sensor.
- Replace the Left and Right Window Lock Sensor ⇒ page 345 & page 347.

SE Code: 51.01:10 - Problem with the Service Station door sensor

Problem Description:

Error detected with the sensor on the Service Station Door.

Corrective Action:

- Check that the Printhead Maintenance Cartridge Door Sensor cable is not damaged and is correctly connected to the Interconnect PCA.
- Perform the Sensors service test ⇒ Page 173.
- Replace the Printhead Maintenance Cartridge Door Sensor ⇒ Page 554.

SE Code: 52:01 - A problem with the Drop Detector

Problem Description:

Drop Detector fiber detected.

Corrective Action:

- Switch the Power OFF from the back of the Printer and disconnect the Power cord. Reconnect the power cord and power On the Printer.
- Check that the Ink Funnel is correctly installed. Use the 'Replace Ink Funnel' process to access the funnel.
- Check that there is no obstructions in the funnel, such as media which would block the detector signal.
- Replace the Drop Detector ⇒ Page 377.

SE Code: 52:10 - A problem with the On/Off switch in the Drop Detector

Problem Description:

Drop Detector switch On/Off failure.

Corrective Action:

- Switch the Power OFF from the back of the Printer and disconnect the Power cord. Reconnect the power cord and power On the Printer.
- Check that the Drop Detector cable is not damaged and is correctly connected to the Service Station cable.
- Check that the Service Station cable is not damaged and is correctly connected to the Interconnect PCA.

- Replace the Drop Detector ⇒ Page 377.
- If the System Error continues, replace the Interconnect PCA ⇒ Page 435.
- Replace the Sausalito PCI PCA ⇒ Page 444.

SE Code: 53:10 - Problem with the Media sensor

Problem Description:

An error has been detected with the Media sensor.

Corrective Action:

- Check that the Media Sensor cable is not damaged and is connected correctly to the Interconnect PCA.
- Perform the Substrate Path Sensor service test ⇒ Page 138.
- Replace the Media Sensor ⇒ Page 555.

SE Code: 54:10 - Problem with the Media lever sensor

Problem Description:

Pinch Lever sensor error detected.

Corrective Action:

- Check that the Media Lever Sensor cable is not damaged and is correctly connected to the Interconnect PCA.
- Replace the Media Lever Sensor ⇒ Page 563.

SE Code: 55:10 - Problem with the Line Sensor

Problem Description:

An error has been detected with the Line Sensor.

Corrective Action:

- Switch the Power OFF from the back of the Printer and disconnect the Power cord. Reconnect the power cord and power On the Printer.
- Perform the Line Sensor service test ⇒ Page 162.
- Replace the Line Sensor ⇒ Page 486.
- If the System Error continues, replace the Carriage PCA ⇒ Page 402.

SE Code: 56:10 - Analog encoder calibration has failed

Problem Description:

Analog Encoder calibration failed. There is a problem with the Drive Roller Encoder/sensor

Corrective Action:

- Replace the Encoder Disc and Sensor ⇒ Page 557.

SE Code: 58:10 - Problem with the Color Sensor

Problem Description:

An error detected with the Color Sensor.

Corrective Action:

- Switch the Power OFF from the back of the Printer and disconnect the Power cord. Reconnect the power cord and power On the Printer.
- Check that the Printer has the latest Firmware version, if not, update the firmware to the latest version.
- Perform the 1.6.1 Color Sensor test ⇒ Page 193.
 - If the error is displayed during the printer's initialization, perform the "6.2 Color Sensor service test" ⇒ page 161.
 - If the error is displayed after the printer has initialized, for example when performing a Color Calibration/Linearization, perform the 5.6.3. Open/Close SOL⇒Page 223.
 - If the Color Sensor Shutter opens and closes, but the error is still displayed, replace Color Sensor Assembly ⇒ Page 488.
 - If the Color Sensor Shutter does not open or close, replace the Color Sensor Actuator Assembly ⇒Page 492.
- If the color sensor activator does not elevate or is broken, replace the Color Sensor Actuator Assembly ⇒Page 492.
- If the test is unable to find a good position to open the shutter:
 - Replace the Color Sensor ⇒Page 488.
 - Replace the Encoder Strip ⇒Page 399.
- If the System Error continues, replace the Carriage PCA ⇒ Page 402.

SE Code: 61:01 - Problem with the format of the file

Problem Description:

The file format is incorrect and the Printer cannot process the job. This error is mostly seen when a customer is attempting to print a job from a RIP with an unsupported raster format. The most common cause of this error when the customer does not use the correct printer driver for the RIP being used.

Corrective Action:

- Check that the Printer has the latest Firmware version, if not, update the firmware to the latest version.
- Check if the RIP supports the printer and that the printer driver is installed in the RIP.
- Check that the RIP version is the latest available.

SE Code: 61:08.01 - Job is password protected

Problem Description:

The file cannot be printed because it is password protected.

Corrective Action:

Resend the file without password protection.

SE Code: 61:09 - Communication with the RIP broken

Problem Description:

There is a problem with the communication between the RIP and the Printer. The job cannot be printed, so it is canceled to save media.

Corrective Action:

- Check the connection of the LAN cable from the Printer and from the computer with the RIP application.
- Check to see if there is any error message from the RIP application.

SE Code: 63:04 - Network problem

Problem Description:

Input/Output problem through the Network Connector.

Corrective Action:

- Check that the network cable is correctly connected to the network connector.
- Check that the Printer has the latest Firmware version, if not, update the firmware to the latest version.
- If the System Error continues, replace the Main PCA ⇒ Page 450.

SE Code: 63:05 - The raster data does not arrive quick enough

Problem Description:

The raster data of the job is not arriving quick enough to assure correct printing conditions. If there are pauses, more than 20 seconds, while receiving information from the RIP, the printer will cancel the job to avoid problems with the temperature.

Corrective Action:

- Check that a 1 Gigabit Ethernet Card is being used in the computer with the RIP, make sure it is correctly installed. If necessary, replace the Gigabit Ethernet Card. Do not printer via a hub, as the communication is not quick enough.
- Check the RIP for any error messages. Check that the computer with the RIP application is functioning correctly. Check the HDD is not full, does the computer need to be defragmented etc.
- Check the customer is printing from a computer with the minimum system requirements, check the RIP documentation for details.
- Check if the RIP option "RIP while printing" is enabled. If it is enabled this could cause the computer to run slowly if it does not have sufficient power.
- As a workaround the customer could reduce the resolution of the job, or increase the number of passes, in order to reduce the need for the bandwidth.

SE Code: 65:04 - I/O port problem

Problem Description:

Input/Output problem through an unknown port.

Corrective Action:

- Check that the unknown port cable is correctly connected to the Printer.

- Check that the Printer has the latest Firmware version, if not, update the firmware to the latest version.

SE Code: 66:08 - Cannot print on the current type of media

Problem Description:

The paper type has changed since the file was sent, so the file cannot be printed on the paper type currently loaded.

Corrective Action:

- Resend the file to be printed on the current paper type.
- Change the paper type to the type that was loaded when the file was originally sent.

SE Code: 71:19 - Mis-match of printer information

Problem Description:

Different serial numbers detected in Main NVM (hard disk) and the Backup NVM (in ISS PCA).

Corrective Action:

- Perform the Error 71:19 Recovery ⇒ Page 132.



NOTE: Do not change the Ink Supply tubes and the Hard Disk at the same time as this will cause the system error 71:19.

SE Code: 72:04 - Generic firmware error

Problem Description:

Generic Firmware error.

Corrective Action:

- Switch the Power OFF from the back of the Printer and disconnect the Power cord. Reconnect the power cord and power On the Printer.
- Check that the Printer has the latest Firmware version, if not, update the firmware to the latest version.

SE Code: 73:03 - Problem with the Carriage encoder

Problem Description:

Carriage encoder reading error.

Corrective Action:

- Switch the Power OFF from the back of the Printer and disconnect the Power cord. Reconnect the power cord and power On the Printer.
- Check that the Printer has the latest Firmware version, if not, update the firmware to the latest version.
- Perform the Scan Axis service test ⇒ Page 157.
- Perform the Substrate Path service test ⇒ Page 133.

SE Code: 74:01 - Error upgrading firmware file

Problem Description:

Error uploading firmware update file.

Corrective Action:

- Switch the Power OFF from the back of the Printer and disconnect the Power cord. Reconnect the power cord and power On the Printer.
- Resend the firmware update file to the Printer.

SE Code: 74:04 - Request to upgrade the firmware

Problem Description:

This error is displayed when the current firmware does not support the installed PrintMech PCA.

Corrective Action:

- Install the latest firmware through the Embedded Web Server.

SE Code: 77:04 - Embedded Web Server internal software error

Problem Description:

Embedded Web Server internal software error.

Corrective Action:

- Switch the Power OFF from the back of the Printer and disconnect the Power cord. Reconnect the power cord and power On the Printer.
- Check that the Printer has the latest firmware version, if not, update the firmware to the latest version.

SE Code: 78.01:04 - Media settings error

Problem Description:

Media Settings are missing or corrupt.

Corrective Action:

- Check that the media selected in the RIP is also present in the firmware of the printer.
- Upgrade the printer's firmware.
- Upgrade the RIP and the RIP's driver
- Resend the file

SE Code: 78.02:01 - End of roll detected on the Rewinder

Problem Description:

The printer has reached an end of roll condition. Media moving, but input spindle not rotating

Corrective Action:

- If the roll is not finished, unload the paper and load it again.
- Load a new roll of media.
- Check the media is not slipping on the spindle.

SE Code: 79:03 - Generic firmware error I

Problem Description:

Generic Firmware error.

Corrective Action:

- Switch the Power OFF from the back of the Printer and disconnect the Power cord. Reconnect the power cord and power On the Printer.
- Check that the Printer has the latest firmware version, if not, update the firmware to the latest version.

SE Code: 79:04 - Generic firmware error II

Problem Description:

Generic Firmware error.

Corrective Action:

- Switch the Power OFF from the back of the Printer and disconnect the Power cord. Reconnect the power cord and power On the Printer.
- Check that the Printer has the latest Firmware version, if not, update the firmware to the latest version.
- Try using different selections in the RIP to print the image.
- For more detailed information on troubleshooting the 79:04 system error refer to ⇒Page 65.

SE Code: 81:01 - Problem with the Media Drive

Problem Description:

Paper servo shutdown.

Corrective Action:

- If the media is nearing the end of the roll, check the remaining media is not strongly glued to the media core.
- Open the Window, observing all safety procedures check for any visible obstacles restricting the movement of the Drive Roller. If there is a wrinkled mass of media inside the paper path, lift the Pinchwheels (using the Media Lever) and clear the obstruction.
- Check the performance of the rewinder system as it may also cause a servo shutdown.
- Perform the Drive Roller service test⇒ Page 135.
- If the error continues, replace the Media Axis Motor ⇒ Page 422.

SE Code: 81:03 - Problem with setting the encoder position

Problem Description:

It was impossible to correctly stop the servo before setting the encoder position.

Corrective Action:

- Open the Window observing all safety procedures and check for any visible obstacles restricting the movement of the Drive Roller. If there is a wrinkled mass of media inside the paper path, lift the Pinchwheels (using the Media Lever) and clear the obstruction.
- Perform the Substrate Path service test ⇒ Page 133.

- Replace the Media-Axis Motor ⇒ Page 422.

SE Code: 82:01 - Media jam in the platen

Problem Description:

Media jam detected in the Print Platen area.

Corrective Action:

- Open the window observing all safety procedures and clear the Print Platen of any obstruction. Check especially around the area of the media jam sensor, on the left end of the platen.
- Check the cable from the Media Jam Sensor is connected and not damaged.
- Check the reflector assembly on the side of the Carriage is not dirty or damaged. If it is dirty clean it, if it is damaged replace the Media Jam Sensor and reflector.

SE Code: 85:03 - Drive Roller encoder problem

Problem Description:

Problem finding the Drive Roller zero.

Corrective Action:

- Perform the Driver Roller service test ⇒ Page 135.

SE Code: 86:01 - Carriage servo shutdown

Problem Description:

There is a problem with the carriage assembly.

Corrective Action:

- Open the Window observing all safety precautions and check for any visible obstacles restricting the movement of the Carriage Assembly. If there is a wrinkled mass of media inside the paper path, lift the Pinchwheels (using the Media Lever) and clear the obstruction.
- Check that the Carriage Stopper is correctly installed ⇒page 412.
- Perform the "Scan Axis" Diagnostic ⇒ Page 157, depending on the result of the test, you may need to replace the following parts:
 - Scan Axis Motor ⇒page 419.
 - Encoder Strip ⇒page 399.
- Check the cables are correctly connected between the PrintMech PCA and the Scan Axis Motor.
- If the error continues, replace the Scan Axis Motor ⇒ Page 419.

SE Code: 93:11 - Unable to pressurize the IDS

Problem Description:

The IDS must be pressurized but the requested pressure is not achievable in the time given (120 seconds).

Corrective Action:

- Perform the APS service test ⇒Page 146
- Check the air pumps are correctly connected.

- Check the cables from the PrintMech to the Air Pump are connected and not damaged.
- Check that the air tubes connected to the air pressure sensor are not pinched and are correctly connected.
- Check that the air tubes are connected, as this issue could cause this system error to be displayed
- Check the Primer air tubes are connected and not damaged.
- Tap on the relief valve with a screw driver several times to release it from a pressure blockage.
- Remove ALL the Ink Cartridges and reinstall them one by one in to the Printer.
- Replace the APS Assembly ⇒ Page 395.
- Replace the ISS PCA ⇒ Page 391

4 Service Tests, Utilities & Calibrations

Introduction	120
• Diagnostics - Self Test.....	120
• Phone Support	120
Service Tests	120
• Entering the Diagnostic Service Tests Menu	120
• 1. User Interface Menu	121
• • 1.1 Front Panel	121
• 2. Electrical System Menu	123
• • 2.2 Electronics Control.....	123
• • 2.3 Power electronics	128
• • 2.4 All Fans	129
• • 2.5 Hard Disc drive.....	130
• • 2.6 IO Information	130
• • 2.7 Unit information	131
• • 2.8 SE 71.19 Recovery	132
• • 2.9 Set Serial Number and Part Number	132
• 3. Substrate Path	133
• • 3.1 Rewinder System	133
• • 3.2 Drive Roller	135
• • 3.3 Substrate Path Sensor	138
• • 3.4 Vacuum	142
• • 3.5 OMAS diagnostic	142
• • 3.6 Rewinder Motor Polarity.....	143
• 4. Ink system Menu.....	146
• • 4.1 ISS Electronics.....	146
• • 4.2 Air Pressure System	146
• • 4.3 Check Ink Supplies.....	148
• • 4.4 Broken Bag Recovery Menu	148
• • • 4.4.1 Clean Air Tubes.....	149
• • • 4.4.2 Refill Ink Tubes	151
• • • 4.4.3 Recover Broken Bag.....	155
• 5. Scan axis	157
• 6. Carriage Menu	161
• • 6.1 Carriage PCA	161
• • 6.2 Color Sensor.....	161
• • 6.3 Line sensor	162
• 7. Service Station.....	163
• • 7.1 Shuttle Close Loop.....	163
• • 7.2 Drop Detector Test.....	165
• • 7.3 Web Wipe Motor	165
• 8. Heating and Curing.....	167
• • 8.1 Heating	167
• • 8.2 Curing.....	168
• • 8.3 Heating (Dryer) IR Sensor.....	169
• • 8.4 Curing IR Sensor.....	170
• • 8.6 Heating Resistance.....	171
• 9. Cover sensor test	173
• • 9.1 Cover sensor test	173
• 10. Diagnostic Utilities	177

- 10.1 Force Normal Boot 177
- 10.2 Report Tests Version..... 177
- 10.4 Enable/Disable Logs 178
- Emergency Firmware Upgrade 179
- Service Menu 181**
- 1. Service Tests and Utilities Menu 182
 - 1.0 Boot Mode Menu 182
 - 1.1 Report Tests Version 183
 - 1.2 Electrical System menu 184
 - 1.3 Media Path Menu 188
 - 1.3.1 Turn Drive Roller..... 188
 - 1.3.2. Enable/Disable OMAS 189
 - 1.3.3 OMAS Check 189
 - 1.3.3 OMAS Check 189
 - 1.4 Ink System Menu 190
 - 1.5 Scan Axis Menu 192
 - 1.6 Carriage Assembly..... 193
 - 1.7 Service Station..... 194
 - 1.8 Heating and Curing 195
 - 1.11 Show Test Messages 196
- 2. Image Quality Plots 196
 - 2.1 Print ALL Plots..... 196
 - 2.2 Printheads Alignment Menu 197
 - 2.2.1 Test Plot 197
 - 2.2.2 Advanced Test Plot 197
 - 2.2.3 Automatic Printhead Alignment 197
 - 2.2.4 Manual Printhead Alignment Menu..... 197
 - 2.2.4.1 Print Pattern 197
 - 2.2.4.2 Manual Alignment Settings 197
 - 2.3 Substrate Advance 197
 - 2.3.1 Substrate Advance Adjustment 197
 - 2.3.2 Print Adjustment Plot 197
 - 2.3.3 Reset Substrate Advance 198
 - 2.4 Printheads Health 198
 - 2.4.1 Print Test Plot 198
 - 2.4.2 Advanced Test Plot 198
 - 2.4.3 Only for Escalations 198
 - 2.4.4 Clean ALL Printheads..... 198
 - 2.5 Geometry Check 199
- 3. Inks On Substrate Test 199
 - 3.1 Print Ink Test Plot 199
- 4. Reset Life Counters (NEVER DONE BY CUSTOMER) 199
 - 4.0 Reset Maintenance Kit Usage 199
 - 4.3 Reset Substrate Path Menu 200
 - 4.4 Reset ISS Menu 200
 - 4.5 Reset Scan Axis Menu 200
 - 4.6 Reset Carriage Menu 200
 - 4.7 Reset Service Station Menu 201
 - 4.8 Reset Heating & Curing 201
- 5. Service Calibrations 201**
- 5.3 Substrate Path Menu 201
 - 5.3.1 Paper Advance Calibration 201
 - 5.3.2 OMAS calibration 207
 - 5.3.3 OMAS Temperature Calibration 211

- 5.3.4 Vacuum Calibration..... 212
- 5.3.5 Rewinder CO Voltage Calibration 213
- 5.5 Scan Axis Menu 213
 - 5.5.1 Scan Axis Calibration 213
 - 5.5.2 Drop detector calibration 216
- 5.6 Carriage Menu 217
 - 5.6.1 Line Sensor Calibration 217
 - 5.6.2 Primer Calibration..... 220
 - 5.6.3 Open/Close SOL..... 223

Introduction

This chapter explains how to use the Service Tests, Utilities and Calibration. Each part is shown step by step in order that it is displayed on the Front Panel. If the Test, Utility or Calibration should fail and display a system error, we explain where to go in the Service Manual to either troubleshoot the error or fix it directly.



NOTE: If possible, always perform the related Service Test on a component that you are about to replace, to confirm it has failed.

Diagnostics - Self Test

Whenever the Printer is switched ON, it automatically performs a series of internal self tests and mechanical initialization sequences. If any of the parts fail during this test, a system error will display and you should consult "System Error Codes and Warnings - Explanation" on page 75.

Phone Support

Some of the tests, utilities and calibrations are simple to perform and there are parts of this chapter that a Call Agent can use to fix the printer over the phone by asking the customer to perform some of the procedures shown here. These procedures have a telephone icon in the corner of the page.

Remember that the Key combination for the Customer to Enter the Service Tests and Utilities is different from the one that the Customer Engineer will use.

Service Tests

Entering the Diagnostic Service Tests Menu

1. Make sure the printer is switched OFF from the power switch on the front of the printer and **NOT** from the power switch on the back of the printer.
2. For Call Agents who will request the User to Perform certain troubleshooting action, hold the **Down** arrow key and the **Cancel** key down and switch the printer **ON** using the front power switch. Wait until you hear one beep (usually after 5 seconds) before releasing ALL three keys.



- For On-Site Engineers, hold the **Up** arrow key and the **Cancel** key down and switch the printer **ON** using the front power switch. Wait until you hear one beep (usually after 5 seconds) before releasing ALL three keys.



- Once inside the Service Tests Menu use the **Arrow** keys to scroll through the "Service Tests" selections. Press the **OK** key to select the highlighted option.



NOTE: The diagnostic tests work in a special Mode which does NOT require the full Initialization of the Printer. Therefore it is important that once you have finished with the tests, you MUST power OFF the Printer and Power ON again before trying to print.

1. User Interface Menu

1.1 Front Panel

Description

The Front Panel diagnostic test checks the following components and processes.

- Front Panel to formatter communication test
- Front Panel key test
- Front Panel beeper test
- Front Panel display test (pixels)

Procedure

- Go to Diagnostic test>1. User Interface Menu>1.1 Front Panel, and press **OK**.
- The printer checks that the Front Panel is able to communicate correctly with the Formatter. The printer tests Front Panel communication and displays the hardware and firmware versions on the Front Panel.

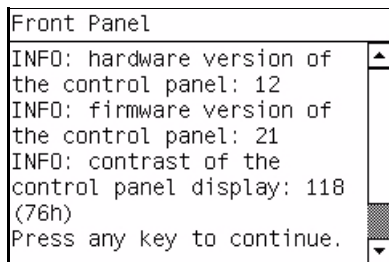

3. Press any key to continue.
4. The printer verifies that all the keys on the Front Panel are working correctly. Ensure the keys are pressed firmly. The printer asks you to push all the key on the Front Panel to verify that they are working, and updates the screen every time you push a key

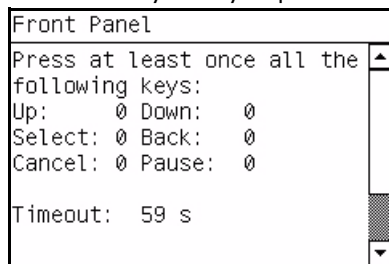

5. Within 30 seconds, push all the buttons on the Front Panel multiple times.
6. Press any key to continue.
7. The printer checks that the beeper works correctly and is audible to the user. The printer tests the Front Panel beeper and asks you to listen for the beeps and confirm the sounds. There should be a beep every second.

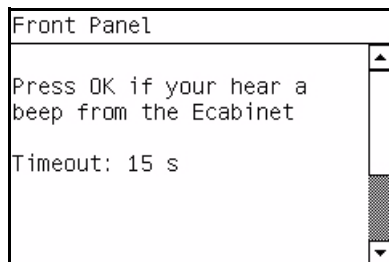

8. If you do not hear any beeps, press **Cancel** to fail the test. If you clearly hear the beeps press **OK** to pass the test.
9. The printer checks that the pixels of the Front Panel display are working correctly, and are able to display a dark, filled in screen or display a completely white screen. The procedure tests the screen and asks you to confirm the results.
10. The front panel will display the following screen to explain the procedure. Press any key to continue.

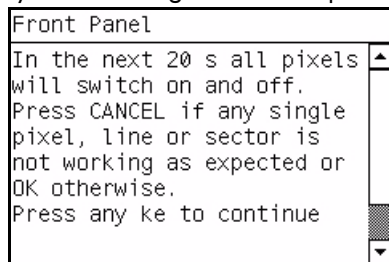

11. The screen displays a white image.

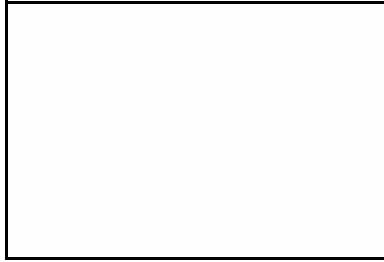

12. After a few seconds the screen displays a black image.



13. The printer asks you to confirm that the two displays were white and black, with no pixelation.

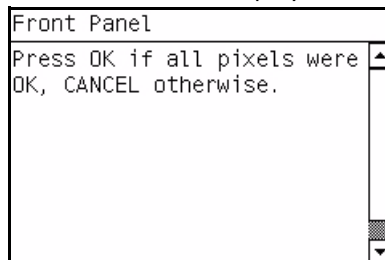

14. Press **Cancel** to fail the test. If the display was correct, press **OK** to pass the test.
15. Press any key to finish the test.

2. Electrical System Menu

2.2 Electronics Control

Description

The purpose of this test is to diagnose a failure in the operation of the:

- Components of the Electronics Module.
- Electronics Module to Carriage and ISS Communication.



NOTE: This test does not test the Hard Disk Drive.

Procedure

1. Go to Diagnostic test>2. Electrical System Menu>2.2 Electronics Control, and press **OK**.

- A message will display on the Front Panel asking whether you would like to check the Formatter. Select **Yes**, and press **OK** to confirm your selection.

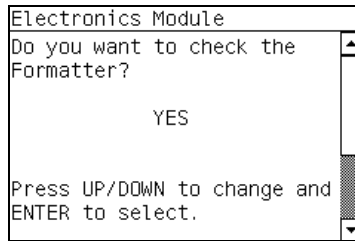

- The printer will get the CPU information and display the information on the Front Panel. Press any key to continue the test:

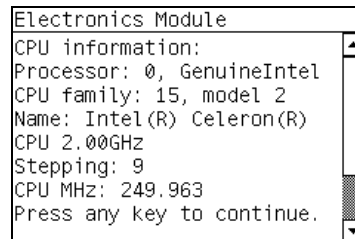

- The printer will now get the CPU Fan Speed and display the information on the Front Panel. Press any key to continue the test:

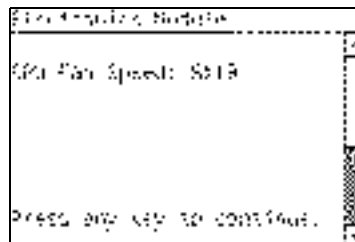

If the CPU Fan Speed is less than 2500, the Front Panel will display system error code **05.1:10** ⇒ page 79.

- The printer will now calculate the amount of memory installed and display the information on the Front Panel. Press any key to continue the test:

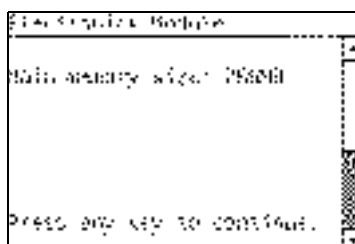

A minimum of 256 megabytes of memory must be installed in the Printer. If not, the Front Panel will display system error code **05.3:10** ⇒ page 80.

- A message will display on the Front Panel asking whether you would like to check the Printer Configuration. Select **Yes** and press **OK** to confirm your selection.

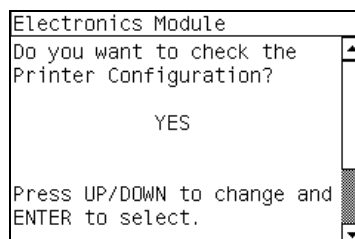

7. The Printer will start the CDS and the following information will be displayed on the Front Panel:

- Starting CDS.

If there is a failure at this point, the Front Panel will display system error code **79:03** ⇒ page 113.

8. The printer will then check the Serial Number and Part Number and display the information on the Front Panel. Press any key to continue the test:

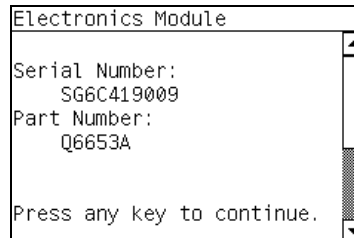

CH955A>42"

CH956A >60"

CQ162A >60" Japan

If the Serial Number does not have assigned a correct 10 character format or the Part number does not have assigned a correct 6 character format, a fail message will display on the Front Panel. In this case, re-enter in to the Service Tests submenu and use the diagnostic '2.8 Error 71:19 Recovery' to set the correct Serial Number (refer to page 132).

9. A message will display on the Front Panel asking whether you want to check the Sausalito. Select **Yes** and press **OK**. This action could take up to 10 minutes.

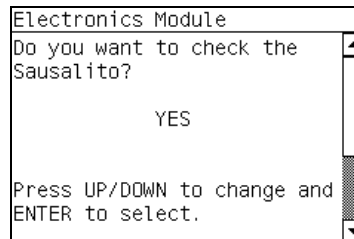

10. The Printer checks the Sausalito PCI PCA and the following messages will be displayed on the Front Panel:

- Starting CDS
- Checking Sausalito PCI.
- Starting Sausalito.
- Checking Impact memory
- Checking Gauntlet memory.

If there is a failure at this point, the Front Panel will display system error code **01.0:10** ⇒ page 78.

11. A message will display on the Front Panel asking whether you would like to check the Power Supply. Select **Yes** and press **OK** to confirm your selection.

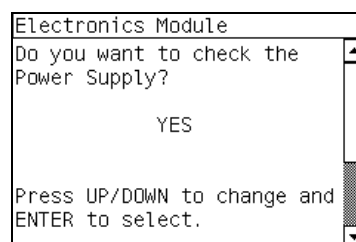

12. The Printer will check various electrical subsystem, if there is an error at any time, use the information on chapter 3 ⇒ page 73, to solve the issue.

13. A message will display on the Front Panel asking whether you would like to check the PrintMech. Select **Yes** and press **OK** to confirm your selection.

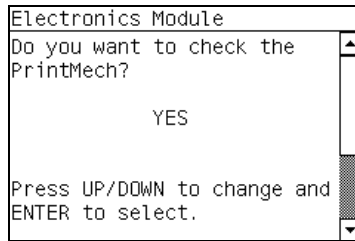

14. The Printer will check various electrical subsystem, if there is an error at any time, use the information on chapter 3 ⇒ page 73, to solve the issue.
15. A message will display on the Front Panel stating that the delSol has been detected and asking whether you would like to Continue. Press any key to continue:

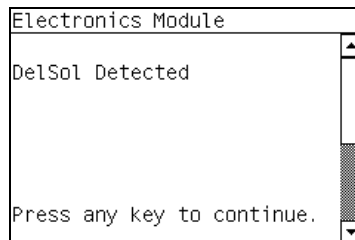

16. A message will display on the Front Panel asking whether you would like to check the Interconnect. Select **Yes** and press **OK** to confirm your selection:

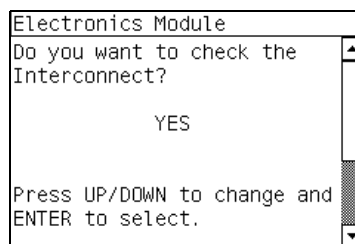

17. The Printer will check the Interconnect PCA and the following messages will be displayed on the Front Panel:

- Starting CDS.

If there is a failure at this point, the Front Panel will display system error code **79:03** ⇒ page 113.

- Getting unit config.

If the current Part Number is not in the correct 6 character format, the Front Panel will display a fail message. In this case, re-enter in to the Service Tests submenu and use the diagnostic "14.2 Error 71:19 Recovery" to set the correct Serial Number (refer to page 132).

- Starting Tests GPIO.

If there is a failure at this point, the Front Panel will display system error code **01.0:10** ⇒ page 78.

- Checking GPIO channels.

At this stage, the Printer reads and checks the default GPIO values in the Interconnect PCA when all the cables are connected and all the sensors give the default value or the current state. The results will be displayed on the Front Panel and you can press any key to scroll through the information.

```
Electronics Module
Window Sensor:      0 OK
SS Door Sensor:    0 OK
Media Sensor:      1 OK
Pinch Wheel Sensor: 0 OK
PM Check Cable:   0 OK
DD Goods:         0 OK
Press any key to continue.
```

If any of the channels cannot be read, the Front Panel will display system error code **01.0:10** ⇒ page 78.

18. A message will display on the Front Panel asking whether you would like to check the Carriage Communication. Select **Yes** and press **OK** to confirm your selection:

```
Electronics Module
Do you want to check the
Carriage Communication?

                YES

Press UP/DOWN to change and
ENTER to select.
```

19. If you select **Yes**, the following message will display on the Front Panel:

```
Electronics Module
Has the carriage supply LED
been switched on?

                YES

Press UP/DOWN to change and
ENTER to select.
```

20. Open the Window, position your head as close as possible to the platen in order to check if the Carriage power light is ON (a faint green light on the carriage PCA). Select **Yes** or **No** by using the **Up** and **Down** keys and press **OK** to confirm your selection.

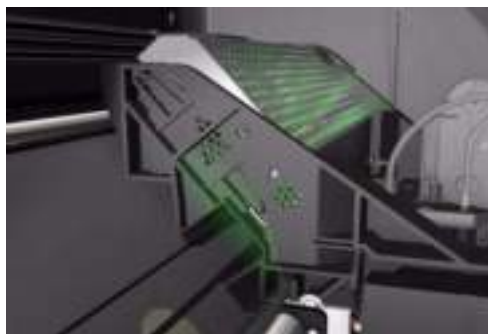

NOTE: The LED is very faint and it may not be obvious in a room with strong lighting.

If you select **Yes**, then the Front Panel will display:

- Starting Carriage.

If there is a failure at this point, the Front Panel will display system error code **02.1:10** ⇒ see page 79. Check also system error code **11:10** ⇒ see page 81 or system error code **01.0:10** (refer to page 78).

- Checking Carriage rev.

If there is a failure at this point, the Front Panel will display system error code **02.1:10** ⇒ see page 79. Check also system error code **11:10** ⇒ see page 81.

21. A message will display on the Front Panel asking whether you would like to check the ISS Communication. Select **Yes** and press **OK** to confirm your selection.

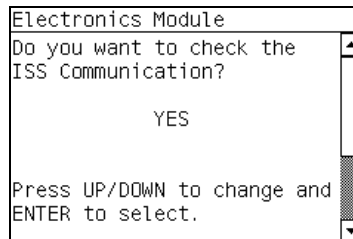

22. If you select **Yes**, the Printer will check the ISS Communication and the following information will be displayed on the Front Panel:

- Starting Sausalito.

If there is a failure at this point, the Front Panel will display system error code **01.0:10** ⇒ page 78.

- Checking ISS PCA rev.

At this stage, the Front Panel displays the value for the ISS PCA revision and asking whether you would like to Continue. Press any key to continue:.

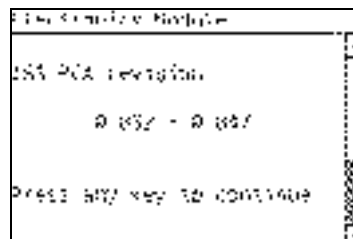

23. When the Front Panel displays the following message, check that all the Ink cartridges are correctly installed. Press any key to continue.

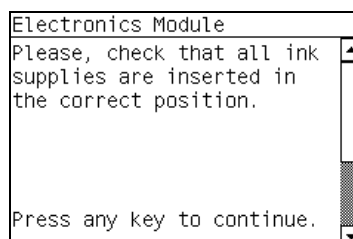

2.3 Power electronics

Description

This setting must be configured after installing a new Heaters Control Assembly. After installation, the onsite engineer will have a coded number which came with the new part, this coded number must be entered here in the menu. The coded number will enable the printer to accurately measure the voltage in the Dryer Assembly. This is required in order to achieve a greater control of the power applied to the system.

Procedure

1. Go to Diagnostic test>2. Electrical System Menu>2.3 Power electronics, and press **OK**.
2. A message will be display on the Front Panel. Use the up and down keys to set the Calibration Value and press the OK key.

```
Power electronics calib.
-----
Calibration value: 1393
(Max= 1463, Min= 1323)

Use UP&DOWN arrows to
adjust the value, ENTER to
confirm the value
```



3. The following screen is displayed, press the OK key to confirm the selection.

```
Power electronics calib.
-----
Calibration value: 1393

ENTER to accept, CANCEL to
cancel
```



4. The following screen is displayed, press any key to finish.

```
Power electronics calib.
-----
Press any key to shutdown
the system.
```



2.4 All Fans

Description

This test checks the Printer's cooling fans. The array of fans are selected individually.

- Curing Fans,
- Top Cover Fans
- Rear Fans.

The test will switch on all the fans of the selected array, so a visual check can be made to verify if they are working or not.

Procedure

1. Go to Diagnostic test>2. Electrical System Menu>2.4 All fans, and press **OK**.

2. The following is displayed on the front Panel, initializing various subsystems required to perform the test.

```
All Fans System
Starting Impact...
Starting Arm...
Starting PowerSupply...
Starting
TestsPwm...TestsGpio...
```

2.5 Hard Disc drive

Description

The hard disc drive service test checks the following:

- Protection status test (protected/not protected)
- Partition configuration test
- System file contents (sanity check for critical files)

Procedure

1. Go to Diagnostic test>2. Electrical System Menu>2.5 Hard Disc Driver, and press **OK**.
2. The printer asks you if you want to perform this test, select **Yes**. Press **OK** to confirm your selection.
3. The printer reads the current protection status of the hard disc drive and displays it on the Front Panel.
4. Press any key to continue.
5. The printer checks the hard disc drive partitions for faults. The printer asks you if you want to perform this test, select **Yes**.
6. The printer reads the current partition configuration of the hard disc drive and displays it on the Front Panel.
7. Press any key to continue.
8. The printer performs a sanity check to verify hard disc consistency. The printer asks you if you want to perform this test, select **Yes**.
9. The printer reads and displays the current file system contents of the formatted partitions of the hard disc drive.
10. Press any key to continue.
11. The printer performs a sanity check of the hard disc drive to check the hard disc drive consistency. A progress bar on the Front Panel indicates the percentage to completion.
12. Press any key to continue to finish the test.

2.6 IO Information

Description

The IO information diagnostic test retrieves and displays information you may need when troubleshooting a network problem. The following information is displayed:

- IP address
- Gateway address

- Subnet mask

Procedure

1. Go to Diagnostic test>2. Electrical System Menu>2.6 IO Information, and press **OK**.
2. The Printer will initialize and the Front Panel will display the following messages:
 - Getting IO Interface.
 - Getting Interface info.

If there is a failure at this point, the Front Panel will display an error.

If no active interface is found, the Front Panel will display “No active interface found. Press any key to finish”.

3. Once the IO information is obtained, it is displayed on the Front Panel. Press any key to exit.

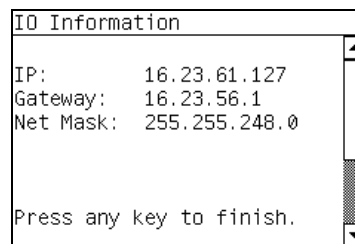

4. Once the process is completed, OK will be displayed on the Front Panel.

2.7 Unit information

Description

This option allows you to view the following Printer information:

- Firmware version.
- Serial Number.
- Part Number.

Procedure

1. Go to Diagnostic test>2. Electrical System Menu>2.7 Unit Information, and press **OK**.
2. The Front Panel will display the various electrical subsystems being initialized in order to perform the test, if there is a failure at this point the Front Panel will display a system error, troubleshoot the system error using Chapter 3: System Error codes.

If the Serial Number does not have a correct 10 character format assigned or the Part number does not have a correct 6 character format assigned, a fail message will display on the Front Panel. In this case perform the diagnostic '71:19 Recovery' to set the correct Serial Number (refer to page 132).

If there is a failure at this point, the Front Panel will display an error.

3. Once the Unit information is obtained, it is displayed on the Front Panel. Press any key to exit.

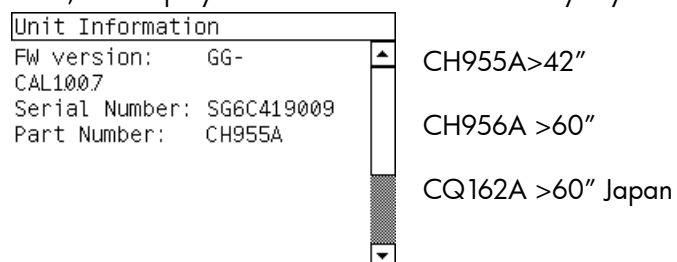

4. Once the process is completed, OK will be displayed on the Front Panel.

2.8 SE 71:19 Recovery

Description

The purpose of this utility is to set the Serial Number and Part Number in case both the Hard Disk Drive and the Ink Supply Tubes are replaced at the same time.

Procedure

1. Go to Diagnostic test>2. Electrical System Menu>2.8 SE 71:19 Recovery, and press **Ok**.
2. The Printer will check if the system error code 71:19 has been recorded and the following message will display on the Front Panel:

- Checking SE log.

If the Printer fails to find the system error code 71:19, the Front Panel will display **Error: Utility not available**. In this case press any key to exit.

3. If a system error code is detected, the Printer will start the recovery procedure and the following messages will be displayed on the Front Panel:

- Starting NvmMain.
- Starting NvmBackup.
- Getting Serial Number.
- Checking Serial Number.
- Starting Nvm.
- Getting Part Number.

If there is a failure at this point, the Front Panel will display system error code **79:03** ⇒ page 113.

4. The Printer will ask you about the location of information do you want to keep. Information held in the ISS PCA or information held in the HDD.
5. Once the process is completed, OK will be displayed on the Front Panel.

2.9 Set Serial Number and Part Number

Description

The purpose of this Service Utility is to set the Serial Number and Part Number of the Printer.

Procedure

1. Go to Diagnostic test>2. Electrical System Menu>2.9 Set SN and PN, and press **Ok**.
2. The Printer displays the current Serial Number and the new Serial Number of the Printer.

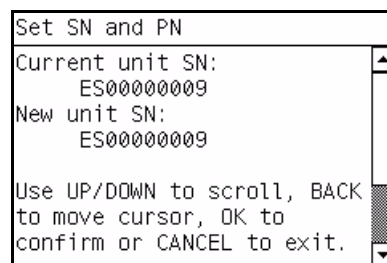

3. Use the **Up** and **Down** keys to go through the digits and press the **OK** key to go to the next digit. You can press the **Cancel** key at any time to exit the utility without making any changes.

The Printer displays the current part number and the new part number of the Printer.

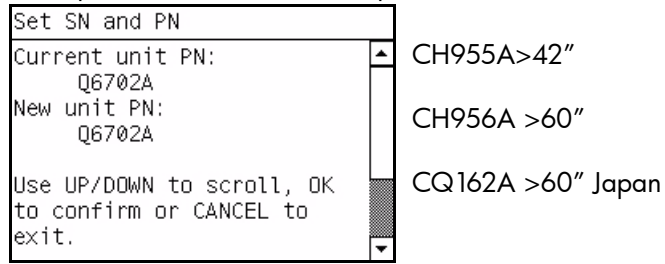

4. Use the **Up** and **Down** keys to go through the digits and press the **OK** key to go to the next digit. You can press the **Cancel** key at any time to exit the utility without making any changes.

The printer displays the new serial number and part numbers for confirmation. At this point, they are not saved.

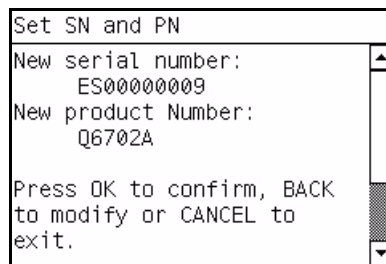

5. Double check that the values displayed are what you wanted to enter. If the values are not the correct, press **Cancel** to reenter them. If the values are correct, press **OK** to confirm.

If the utility exits correctly, the Front Panel displays the OK screen.

3. Substrate Path

3.1 Rewinder System

Description

The Rewinder System diagnostic test checks the following components and processes, any failures will be displayed as a system error, which can then be used to troubleshoot and solve the problem.

- Rewinder Motor without substrate loaded (motors, encoder)
- Rewinder Motor with substrate loaded (friction)

Procedure

1. Go to Diagnostic test>Substrate path>3.1 Rewinder System.
2. The Front Panel will display the various electrical subsystems being initialized in order to perform the test, if there is a failure at this point the Front Panel will display a system error, troubleshoot the system error using Chapter 3: System Error codes.
3. The following screen is displayed, remove the media and spindle from the printer.

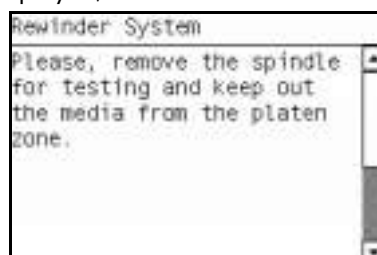

4. Press any key to continue.

- The printer will now test the Rewinder without the Spindle, moving in an open loop in one direction, after the test the following message is displayed:

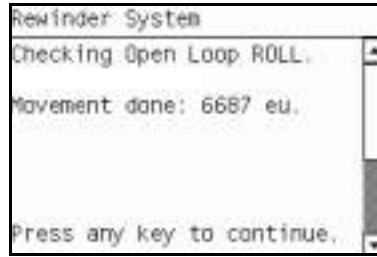

```
Rewinder System
Checking Open Loop ROLL.
Movement done: 6687 eu.
Press any key to continue.
```

- Press any key to continue.
- The printer will now test the Rewinder without the Spindle moving in a open loop in the opposite direction, after the test the following message is displayed:

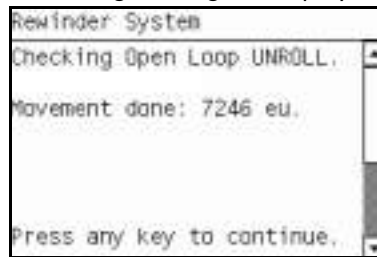

```
Rewinder System
Checking Open Loop UNROLL.
Movement done: 7246 eu.
Press any key to continue.
```

- Press any key to continue.
- The following screen is displayed, install the spindle with the media into the spindle holder.

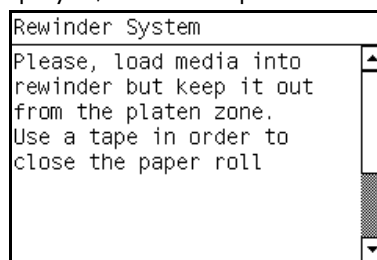

```
Rewinder System
Please, load media into
rewinder but keep it out
from the platen zone.
Use a tape in order to
close the paper roll
```

Use tape to secure the lead edge of the media to the roll to stop the media from unwinding during the test. Install the spindle into the printer. Press any key to continue.

- The printer will now test the Rewinder with the Spindle, moving in an open loop in one direction, after the test the following message is displayed:

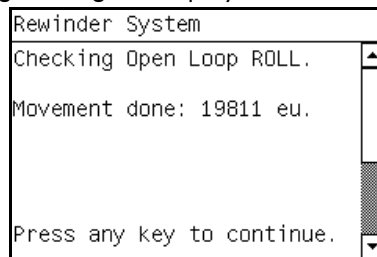

```
Rewinder System
Checking Open Loop ROLL.
Movement done: 19811 eu.
Press any key to continue.
```

- Press any key to continue.

- The printer will now test the Rewinder with the Spindle moving in a open loop in the opposite direction, after the test the following message is displayed:

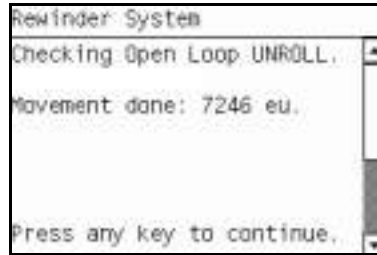

- Press the cancel key to repeat the test, or press OK to continue the test.
- Press OK to continue. The front panel displays the following test, the printer now tests the friction in rewriter with media loaded.

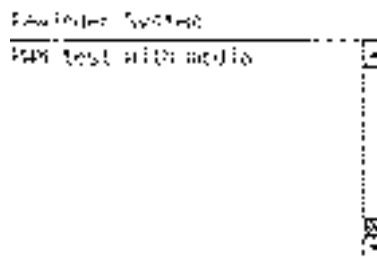

- The results of the test are displayed on the front panel., press any key to finish the test.

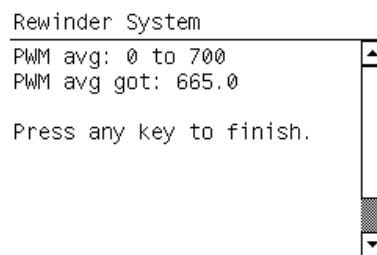

3.2 Drive Roller

Description

The purpose of this test is to diagnose a failure in the operation of components related to the Driver roller.

You must perform the Paper Drive Test after:

- System Error Code 81:YX.
- System Error Code 41:YX.
- System Error Code 73:YX.



NOTE: IF POSSIBLE ALWAYS PERFORM THIS TEST BEFORE REPLACING ANY COMPONENT OF THE MEDIA-AXIS.

Procedure

- Go to Diagnostic test>Substrate Path Menu>3.2 Drive Roller.
- The Front Panel will display the various electrical subsystems being initialized in order to perform the test, if there is a failure at this point the Front Panel will display a system error, troubleshoot the system error using Chapter 3: System Error codes.

If there is no system error code displayed on the Front Panel but the Printer hangs up and the last message on the Front Panel is "Booting up the Carriage" this would indicate that the Carriage ASIC could not be detected. Troubleshoot this problem using the system error **02.1:10** ⇒ see page 78.

- The printer will now check for the presence on the Color Meter and the following will be displayed on the front panel:

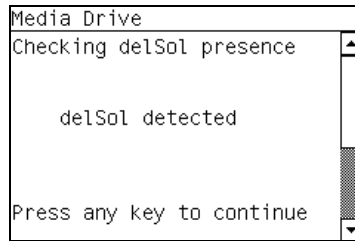

- The Printer will program the duty cycle for the PWM test for the Paper Drive Movement and leave it disabled and the following message will be displayed on the Front Panel:

- Prog slow PWM paper.

If there is a failure at this point, the Front Panel will display system error code **01.0:10** ⇒ page 78.

- Before continuing, the following message will display on the Front Panel. Remove the media if it is still loaded and make sure you stay out of the Print Platen area if the Window is open.

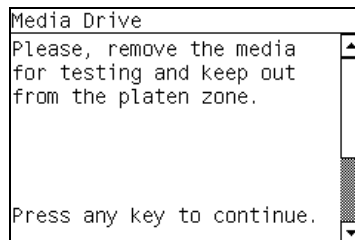

- The Printer will now test the Paper Drive moving in an open loop in one direction and the following message will be displayed on the Front Panel. Press any key to continue the test:

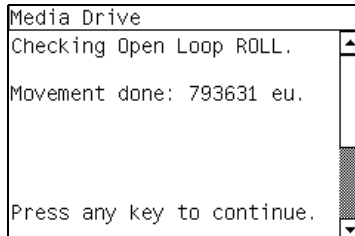

Check that the movement done is more than 100 encoder units (in absolute value). If the movement done is less than 100 encoder units then open the Window and check for any visible obstacles restricting the movement of the Drive Roller or the Overdrive Assembly. In this case, press any key to finish the test.

- The Printer will now test the Paper Drive moving in an open loop in the opposite direction and the following message will be displayed on the Front Panel. Press any key to continue the test:

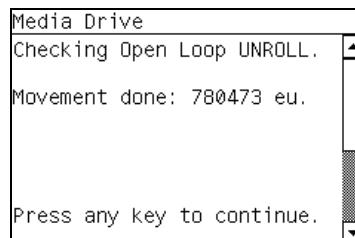

Check that the movement done is **more** than 100 encoder units (in absolute value). If the movement done is **less** than 100 encoder units then open the Window and check for any visible obstacles restricting the movement of the Drive Roller or the Overdrive Assembly.

If the Encoder Units is **less** than 100, the Printer will request you to follow these instructions:

- a. Manually load a sheet of paper in to the Printer (an A4 sheet).
 - b. The Printer will test the Media Drive moving in an open loop.
 - c. Perform a visual check during the test. The Front Panel will ask you if the paper moved or not:
 - If the paper moved, the Front Panel will display system error code **56:10** ⇒ page 108.
 - If the paper **did not** move, the Front Panel will display system error code **41:10** ⇒ page 101.
8. The Printer will now check the Paper Drive servo system and the following messages will be displayed on the Front Panel:
- Starting Paper Motor.
 - Starting Paper Axis.
 - Calib. Analog Encoder.

If there is a failure at this point, the Front Panel will display a system error code, for more information on troubleshooting this error code, refer to page 73.

Once the Analog Encoder calibration is completed, the Front Panel will display the results:

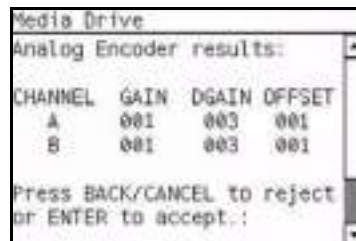

Acceptable values are:

- Gain: between 0 and 5
- DGain between 0 and 15
- Offset: between -80 and 80

If the results are acceptable, press **OK**. If the results are unacceptable, then press the **Back/Cancel** key and the Front Panel will display system error code **56:10** ⇒ page 108.

- Starting media Path.
- Homing and repeat. test.

If there is a failure at this point, the Front Panel will display a system error code, for more information on troubleshooting this error code, refer to page 73.

9. The Printer will now check the Paper Drive PWM. Load media in to the Printer and press any key to continue the test.

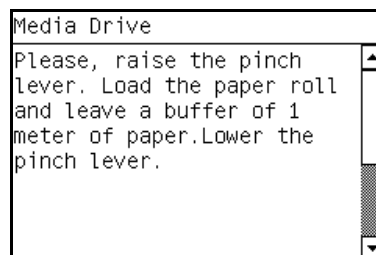

10. When the PWM check is being performed, the following message will be displayed on the Front Panel:

- PWM test with paper.

11. Once the PWM check is done, the results will be displayed on the Front Panel. Press any key to finish the test:

```
Media Drive
PWM avg: 15900 to 33600
PWM avg got: 17674.15
Speed error top limit: 40
Speed error got: 23
PWM StDev: 1.00 to 850.00
PWM StDev got: 739.60
Press any key to finish.
```

If there is a failure at this point, the Front Panel will display:

```
Media Drive
WARNING: High Friction.
PWM avg: 15900 to 33600
PWM avg got: 35000.0
Speed error top limit: 40
Speed error got: 20
PWM StDev: 1.00 to 850.00
PWM StDev got: 120.53
Press any key to finish.
```

12. Once the test is completed, OK will be displayed on the Front Panel and then you will be prompted to press any key to shut down the Printer.
13. Press any key to finish the test.

3.3 Substrate Path Sensor

Description

The purpose of this test is to verify the operation of the following Sensors:

- Left and Right Window lock sensors.
- Media Lever.
- Maintenance Cartridge Door Sensor.
- Media Sensor.
- Media Jam Sensor

Procedure

1. Before starting, first make sure that:
 - The Window is closed.
 - The Maintenance Cartridge Door is closed.
 - The Media Lever is in the lowered position.
 - Paper is unloaded.
2. Go to Diagnostic test>3. Substrate Path Menu>3.3 Substrate Path Sensors.
3. The Printer will initialize the sensors
4. The Front Panel will display the various electrical subsystems being initialized in order to perform the test, if there is a failure at this point the Front Panel will display a system error, troubleshoot the system error using Chapter 3: System Error codes.

5. Before starting to test the sensors, the following message will be displayed to prompt the user to set the sensors to the test default positions. Press any key to continue:

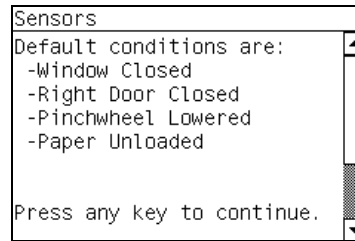

6. The Window Sensor will be tested first. When the following message is displayed on the Front Panel, open the Window and press any key to continue.

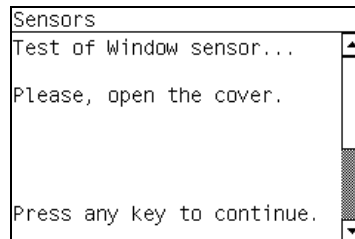

7. If the Window Sensor passes the test, the following message is displayed on the Front Panel. Close the Window and press any key to continue.

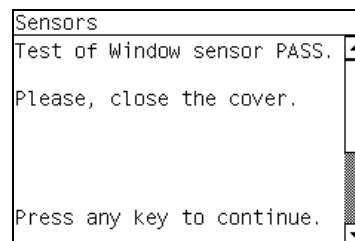

If the Window Sensor fails the test, the Front Panel will display system error code **51:10** ⇒ page 107.

8. The Maintenance Cartridge Door Sensor will be tested next. When the following message is displayed on the Front Panel, open the Maintenance Cartridge Door Sensor and press any key to continue.

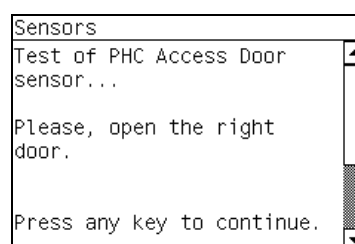

9. If the Maintenance Cartridge Door Sensor passes the test, the following message is displayed on the Front Panel. Maintenance Cartridge Door Sensor and press any key to continue.

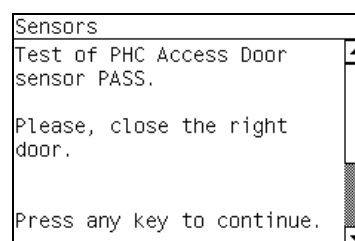

If the Maintenance Cartridge Door Sensor fails the test, the Front Panel will display system error code **51.1:10** ⇒ page 107.

10. The Media Lever Sensor will be tested next. When the following message is displayed on the Front Panel, raise the Paper Lever and press any key to continue.

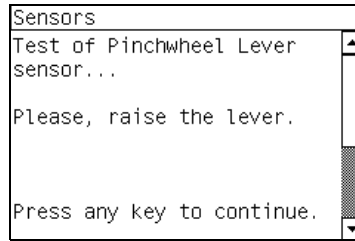

11. If the Media Lever Sensor passes the test, the following message is displayed on the Front Panel. Lower the Paper Lever and press any key to continue.

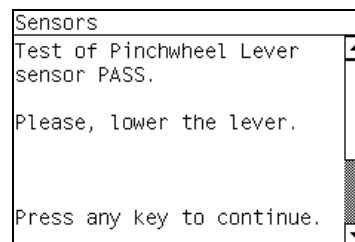

If the Paper Lever Sensor fails the test, the Front Panel will display system error code **54:10** ⇒ page 108.

12. The Media Sensor will be tested next. When the following message is displayed on the Front Panel, raise the Media Lever, load paper, lower the Media Lever, and press any key to continue.

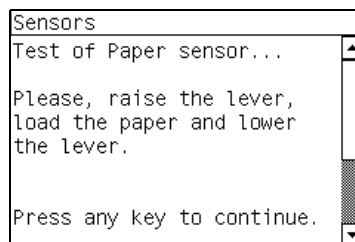

13. If the Media Sensor passes the test, the following message is displayed on the Front Panel, raise the Media Lever, unload paper, lower the Media Lever, and press any key to continue.

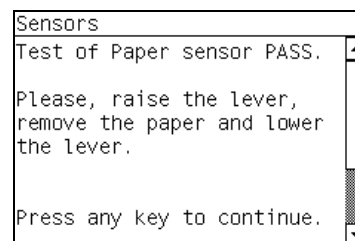

If the Paper Lever Sensor fails the test, the system error **53:10** is displayed ⇒ page 108

- The front panel displays the following message, check that there is nothing in the carriage path and press any key.

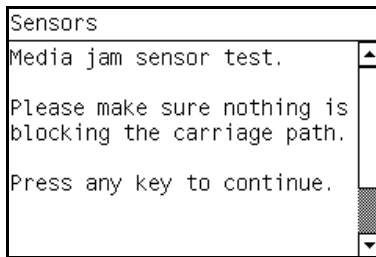

If there is an error with the Media Jam sensor, the system error **82:01** is display ⇒ page 114.

- If the test passes OK the following message is displayed on the Front Panel, press any key to continue.

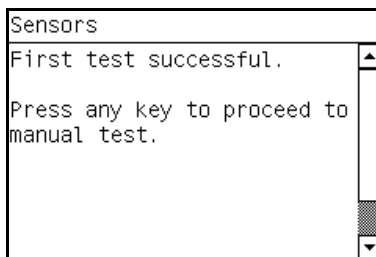

- The following message is displayed. Make sure the parts inside the printer are not too hot. Cover the reflector on the left side of the carriage and at the same time press any key to continue. This verifies that the light going to the sensor is from the reflector and not from another light source.

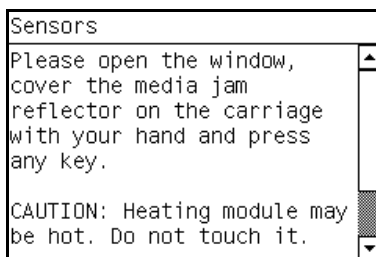

If there is an error with the Media Jam sensor, the system error **82:01** is display ⇒ page 114.

- If the test passes OK the following message is displayed on the Front Panel, press any key to continue.

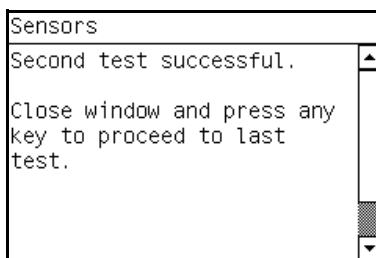

- The following message is displayed. The carriage assembly moves along the Carriage path testing the Media Jam Sensor as it goes along the scan axis.

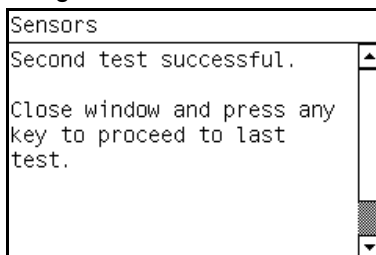

If there is an error with the Media Jam sensor, the system error **82:01** is display ⇒ page 114.

19. If the test passes OK the following message is displayed on the Front Panel, press any key to finish.

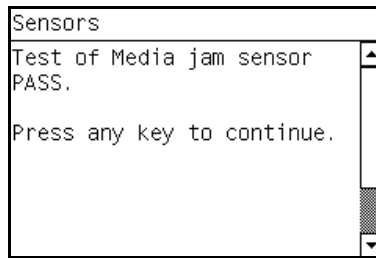

3.4 Vacuum

Description

The purpose of this test is to verify the operation of the Vacuum Fans, to check that they are connected and working.

Procedure

1. Go to Diagnostic test>3. Substrate Path Menu>3.4 Vacuum.
2. The printer asks you to confirm that you want to perform the Vacuum Diagnostic test, select Yes.
3. The printer tests various electrical subsystems and the Vacuum fans.

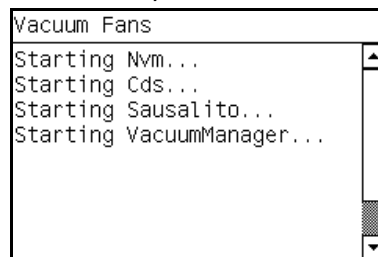

4. If the Vacuum fans are functioning correctly the following is display.

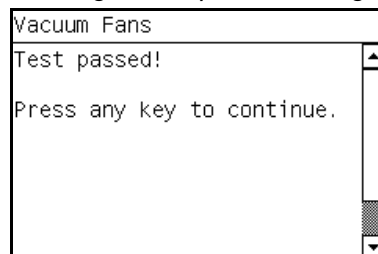

5. Press and key to finish the test.

3.5 OMAS diagnostic

Description

The objective of this test is to check the communication of the OMAS system. OMAS controller PCA, the CAN BUS, the OMAS flat cable and the OMAS sensor.

Procedure

1. Go to Diagnostic test>3. Substrate Path Menu>3.5 OMAS Diagnostic.

It is possible that the Rewinder motor assembly could be installed with the cables swapped over in error, this test is a good way to check that the correct connections have been made.

Procedure

1. Go to Diagnostic test>3. Substrate Path Menu>3.7 Media Jam Sensor.
2. The front panel displays the following message, check that there is nothing in the carriage path and press any key.

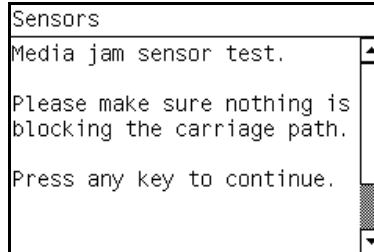

If there is an error with the Media Jam sensor, the system error **82:01** is display ⇒ page 114.

3. If the test passes OK the following message is displayed on the Front Panel, press any key to continue.

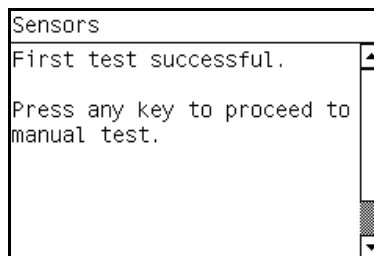

4. The following message is displayed. Make sure the parts inside the printer are not too hot. Cover the reflector on the left side of the carriage and at the same time press any key to continue. This verifies that the light going to the sensor is from the reflector and not from another light source.

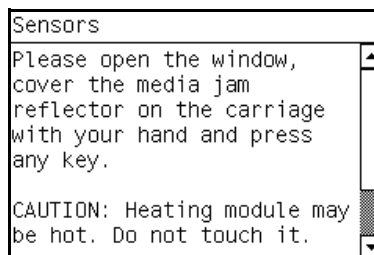

If there is an error with the Media Jam sensor, the system error **82:01** is display ⇒ page 114.

5. If the test passes OK the following message is displayed on the Front Panel, press any key to continue.

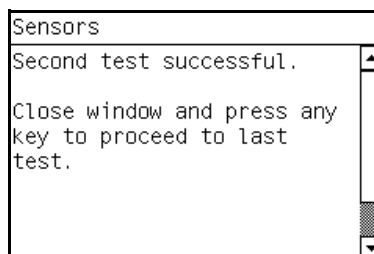

6. The following message is displayed. The carriage assembly moves along the Carriage path testing the Media Jam Sensor as it goes along the scan axis.

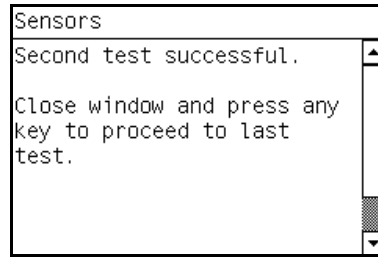

If there is an error with the Media Jam sensor, the system error **82:01** is display ⇒ page 114.

7. If the test passes OK the following message is displayed on the Front Panel, press any key to finish.

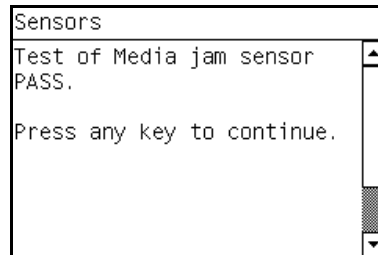

4. Ink system Menu

4.1 ISS Electronics

Description

The ISS Electronics service test checks the Upper and Lower ISS PCA are connected correctly and functioning. If a failure is found, a system error is displayed which can be used to troubleshoot the error using the information in Chapter 3.

Procedure

1. Go to Diagnostic test>4. Ink System Menu>4.1 ISS Electronics.
2. A message will display on the Front Panel asking whether you would like to check the ISS Communication. Select **Yes** and press **OK** to confirm your selection.

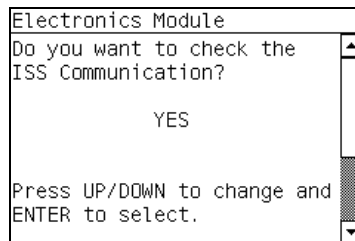

3. If you select **Yes**, the Printer will check the ISS Communication and the following information will be displayed on the Front Panel:

- Starting Sausalito.

If there is a failure at this point, the Front Panel will display system error code **01.0:10** ⇒ page 78.

- Checking ISS PCA rev.

At this stage, the Front Panel displays the value for the ISS PCA revision and asking whether you would like to Continue. Press any key to finish.

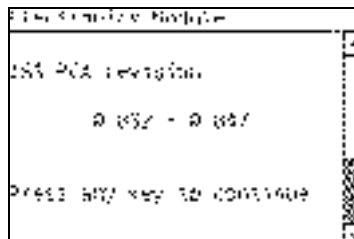

4.2 Air Pressure System

Description

The purpose of this test is to verify the operation of the Air Pressurization System (APS).



NOTE: Perform this test before replacing the APS (if possible), if this test passes, do not replace the APS.

Procedure

1. Go to Diagnostic test>4. Ink System Menu>4.2 Air Pressure System.
2. A message will display on the Front Panel asking whether you want to perform the Air Pressure System diagnostic test, select **Yes** and press **OK**.

3. A message will display on the Front Panel asking you to insert all the Ink Cartridges. Insert all the Ink Cartridges and press any key to continue:

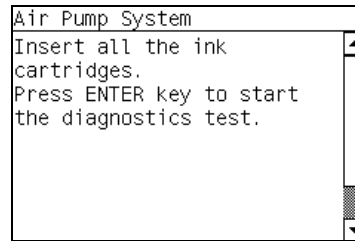

4. The Front Panel will display the various electrical subsystems being initialized in order to perform the procedure, if there is a failure at this point the Front Panel will display a system error, troubleshoot the system error using Chapter 3: System Error codes ⇒ page 73.

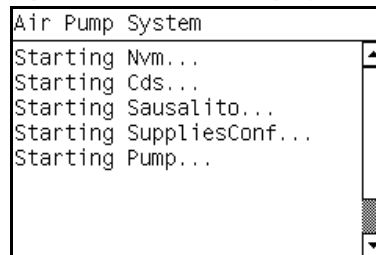

5. The Printer will pressurize the APS and the Front Panel will display the following message:

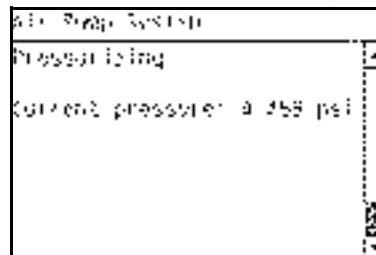

6. The Printer will hold the pressure in the APS and the Front Panel will display the following message:

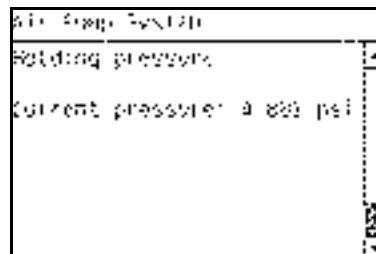

7. The Printer will depressurize the APS and the Front Panel will display the following message:

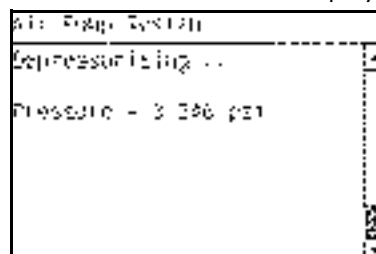

If there is a failure starting the Pump, the Front Panel will display a system error code. For more information on troubleshooting this error code refer to the system errors section ⇒ page 73.

8. Once the test is completed, OK will be displayed on the Front Panel.

4.3 Check Ink Supplies

Description

The purpose of this test is to verify which Ink Cartridges are valid for the purge process and their current available ink level. Some Ink Cartridges may not be able to be accessed (unable to read the Acumen) if previously there had been a failure (faulty, broken bag, etc...).

Procedure

1. Go to Diagnostic test>4. Ink System Menu>4.3 Check Ink Supplies>14.5 Check Ink supplies
2. The Printer will start to initialize and the Front Panel will display the following messages:

- Starting Sausalito.

If there is a failure at this point, the Front Panel will display system error code **01.0:10** ⇒ page 78.

- Starting AcumenSupplies.

If there is a problem while reading the Acumen, the Front Panel will display one of the system error codes:

- **26.n:10** ⇒ page 97
- **01.2:10** ⇒ page 78
- **01.0:10** ⇒ page 78

If there is a failure at this point, the Front Panel will display the message “Replace failing ink supplies after running this utility”.

3. Once the Ink Supplies information is obtained, it is displayed. Press any key to exit.

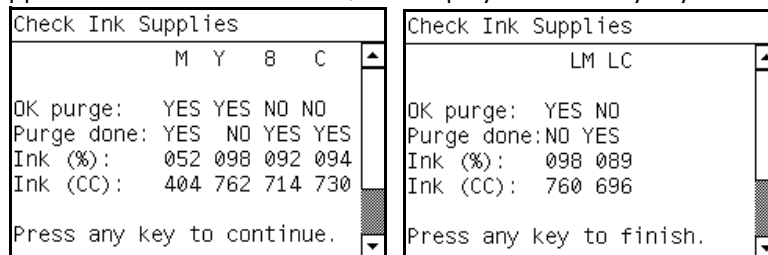

If any part of the Acumen information is invalid, the Front Panel will display an error.

4. Once the process is completed, OK will be displayed on the Front Panel.

4.4 Broken Bag Recovery Menu

Description

The purpose of the menus here is to recover the printer if a broken bag in an Ink Cartridge is detected. A broken bag will stop the printer from functioning and will need to be fixed and cleared of the error before the printer can continue printing normally. If ink leaks from the broken bag and leaves the confines of the ink cartridge, this error is potentially damaging to various parts of the printer.

In order to remove the printer from this system error status and recover the printer to working order the test must be performed in the following order:

- 4.4.1 Clean Air Tubes
- 4.4.3 Recover Broken bag
- 4.4.2 Refill Ink Tubes

The following procedures and menu selections enable the engineer to clear leaked ink from the pressurized air system in the ISS and to remove air bubbles (caused by the broken bag) from the Ink Tubes which can damage the Printheads.

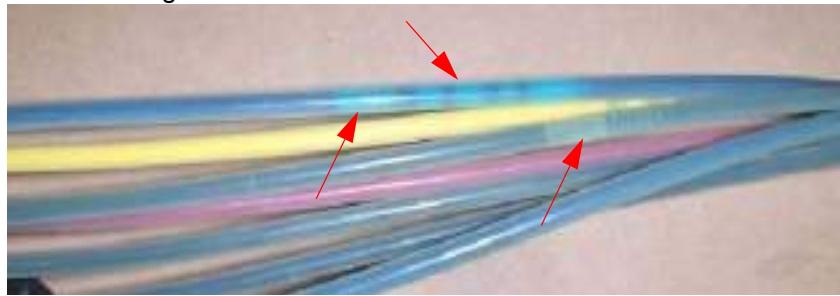

To perform the following procedures the Broken Bag Fixing Tools kit is required (part number CH955-67076).

4.4.1 Clean Air Tubes

Procedure

The procedures and menu selections must be performed if there is ink visible in the air tubes of the APS.

1. Remove the Left Cover and check if the tubes from the APS to the ISS are clean. If the tubes are clean of ink this procedure does not need to be performed, go to page 151 and perform the Refill Ink Tubes to clear any air bubbles from the ink tubes.

However if there are sections of tubing that have ink in them, like the examples indicated below with the red arrows.

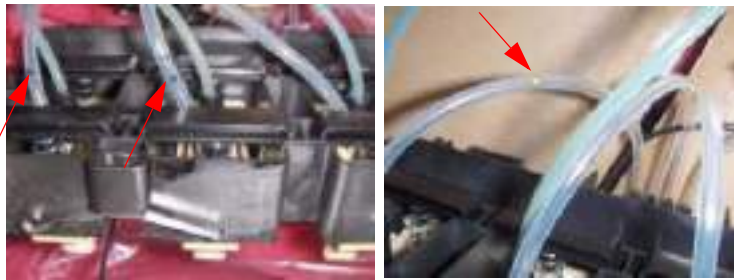

2. Remove all the Ink Cartridges and install the dummy Ink Cartridges from the Broken Bag Fixing Tools kit.
3. One of the dummy Ink Cartridges has two holes at the top, this dummy Ink Cartridge must be inserted into the color slot with the Broken Bag error.

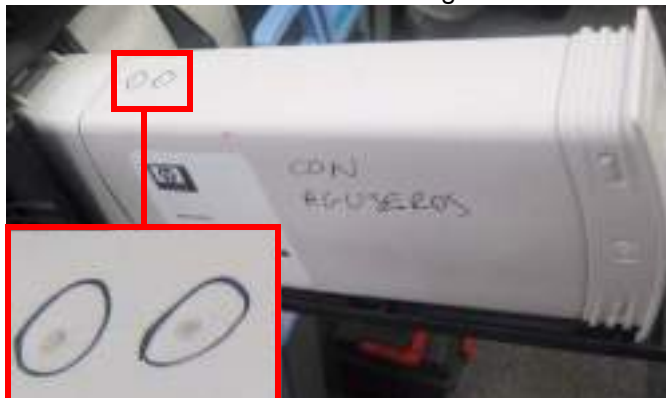

4. Go to Diagnostic test>4. Ink System Menu>4.3 Broken Bag Recovery Menu>4.4.1 Clean Air Tubes, and press **OK**.

5. The following message is displayed on the Front Panel, use the up and down keys to select “Yes” and press “**OK**”.

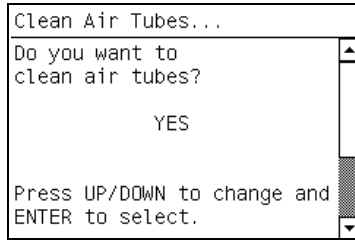

6. The following message is displayed on the Front Panel, use the up and down keys to select “Yes” and press “**OK**”.

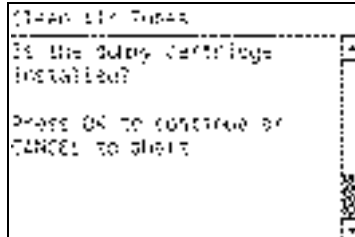

7. The following message is displayed on the Front Panel.

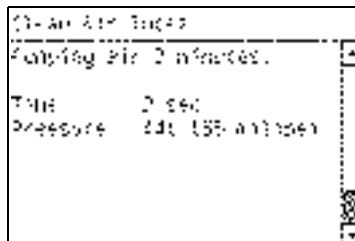

Air is now pumping through the air tubes system, pushing any ink that may be there from the Air tubes into the Dummy Ink Cartridge with the two holes at the top. When this is finished press any key to continue.

8. The following message is displayed on the Front Panel.

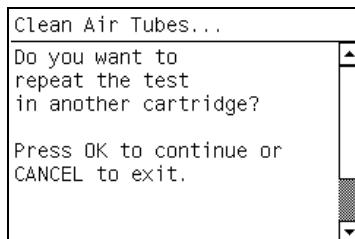

9. Remove the dummy ink cartridge with the two holes and insert it into the other slots that may also have ink in their air tubes, press “**OK**” to continue removing ink from the other air tubes.

When you are sure there is no more ink from the broken bag blocking any of the air tubes, select “**Cancel**”.

- The following message is displayed on the Front Panel, press any key to finish.

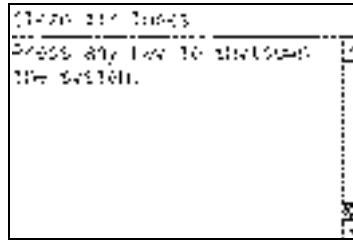

4.4.2 Refill Ink Tubes



CAUTION: This procedure must only be performed after performing the procedure "4.4.3 Recover Broken Bag"

Description

The procedures and menu selections must always be performed if a broken bag has been detected by the printer. In this procedure the printer forces ink from the ink tube that had the broken bag, removing air bubbles, into a syringe.

Procedure

- Remove all the dummy Ink Cartridges and install the normal Ink Cartridges.



NOTE: It is important that the Ink Cartridge with the broken bag, is discarded and replaced with a new Ink Cartridge. **DO NOT** reinstall the Ink Cartridge with the broken bag.

- Go to Diagnostic test>4. Ink System Menu>4.3 Broken Bag Recovery Menu>4.4.2 Refill Ink Tubes, and press **OK**.
- The Front Panel will display the various electrical subsystems being initialized in order to perform the procedure, if there is a failure at this point the Front Panel will display a system error, troubleshoot the system error using Chapter 3: System Error codes.
- The following message is displayed on the Front Panel, using the up and down keys, select the color of the Ink Cartridge that had the broken bag, and press "**OK**".

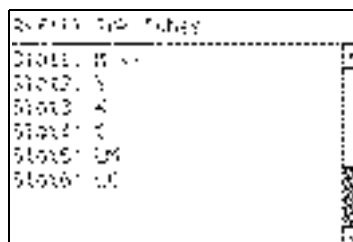

- The following message is displayed on the Front Panel, press "**OK**".

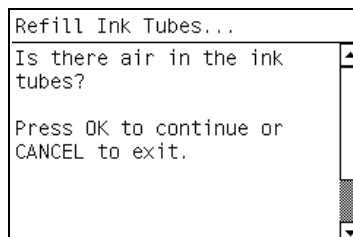

6. Check the new Ink Cartridges are installed, press ok to continue.

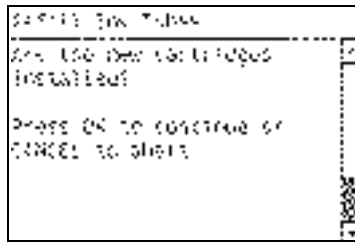

7. The following message is displayed on the Front Panel, open the Front Cover and Carriage Cover and press **OK**.

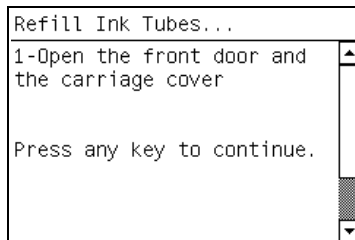

8. The following message is displayed on the Front Panel.

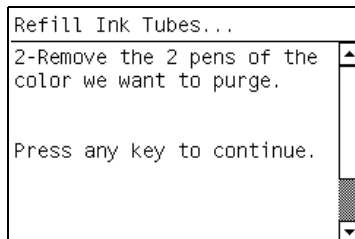

9. Remove the two Printheads of the color affected by the broken bag error, in the example shown below it is Magenta. Press any key on the Front Panel to continue.



10. The following message is displayed on the Front Panel.

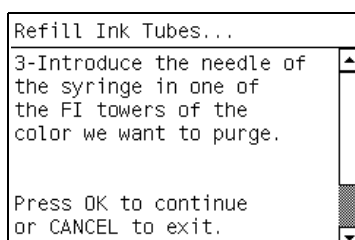

11. Insert the needle connected to the syringe into the FI tower of the color affected. Use the FI of the color which is to the rear of the Carriage, as shown. Press "Ok" to continue.



12. The following message is displayed on the Front Panel.

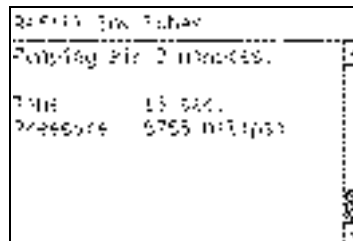

Ink is now pumping through the ink tube, pushing any air bubbles, from the Ink Tubes into the syringe. The amount of ink pumped through the Ink Tube into the syringe is 33cc + air.



13. After 2 minutes the following screen is displayed. Press "Ok" to continue.

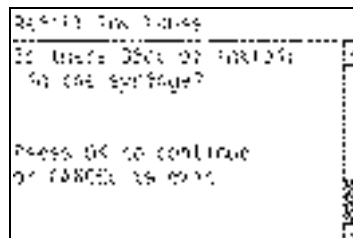

14. The following message is displayed on the Front Panel, press any key to continue.

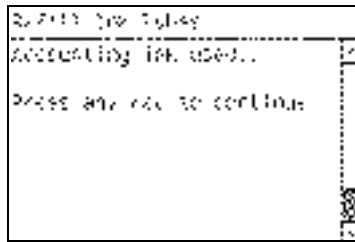

15. The following message is displayed on the Front Panel, press any key to continue.

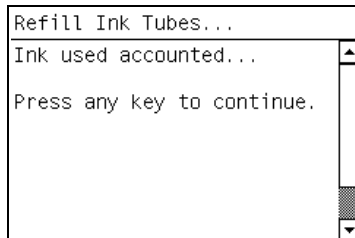

16. The following message is displayed on the Front Panel, press any key to continue.

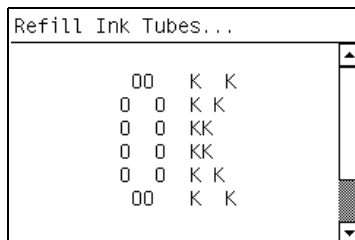

17. The following message is displayed on the Front Panel, if more than one bag was detected as broken or you want to perform the procedure again because the air bubbles have not been completely cleared, press the "Ok" key, if you want to finish the procedure and recover the printer to normal working status, press the "Cancel" key.

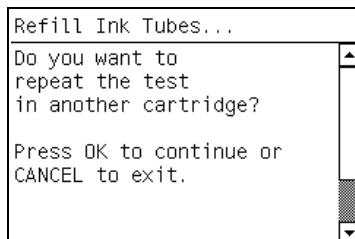

NOTE: If you cannot clear the bubbles from the ink tubes, replace the complete SRK tubes assembly refer to ⇒ page 380.

18. Remove the needle from the FI tower, press any key to continue.

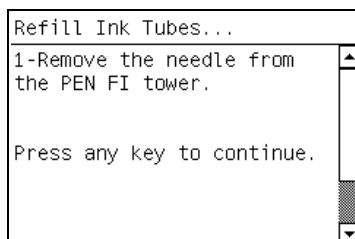

19. Reinstall the Printheads into the Carriage.

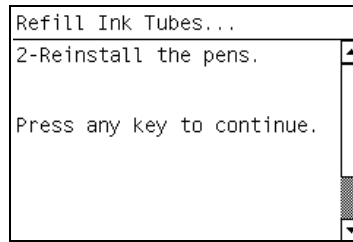

20. Close the Carriage and close the Front Window.

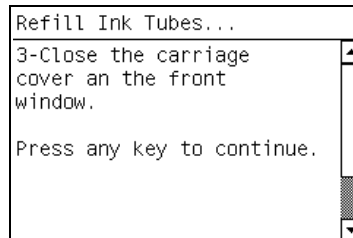

4.4.3 Recover Broken Bag

Description

This option recovers the printer to a ready status after a broken bag has been detected in one of the Ink Cartridges.



NOTE: This option should only be selected if the following has been performed:

- The Ink Cartridge with the broken bag has been replaced with a new Ink Cartridge
- The Air Tubes have been cleaned of any ink

Procedure

1. Go to Diagnostic test>4. Ink System Menu>4.3 Broken Bag Recovery Menu>4.4.3 Recover Broken Bag, and press **OK**.
2. The following message is displayed on the Front Panel, if the Air Tubes are clean of Ink, use the up and down keys to select "Yes" and press "Ok".

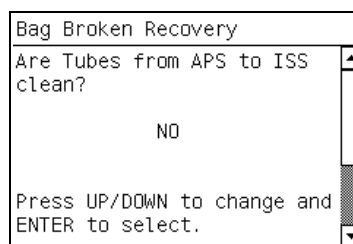

3. The following message is displayed on the Front Panel, use the up and down keys to select "Yes" and press "Ok".

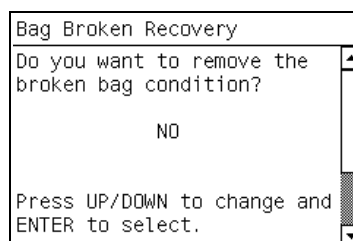

4. The Printer will now scan for a broken bag in the Ink Cartridges and the Front Panel will display the following messages:
 - Starting Gamut.
 - Starting TestGPIO.
 - Detecting Bag Broken.
 - Starting Acumen Supplies.
 - Getting ISS data
 - Starting SuppliesCon....
5. The following message is displayed on the Front Panel if no broken bags are found in the Ink Cartridges, press any key to finish the recovery procedure.

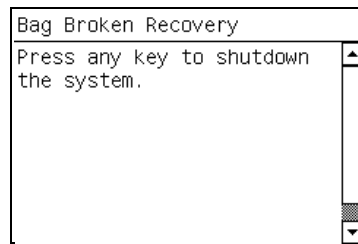

5. Scan axis

5.1 Scan Axis Test

Description

The purpose of this test is to diagnose a failure in the operation of components related to the Scan Axis.

Perform the Scan-Axis Test after:

- System Error Code 86:YX.
- System Error Code 42:YX.
- System Error Code 73:YX.
- System Error Codes related to Scan-Axis shutdown or Carriage jam.



WARNING!: All the cover sensors are disabled when in the service tests menu. If the carriage is moving it will not stop if the window is opened, so be very careful not to put your hands inside.

Procedure



NOTE: Perform this test with the Printheads and the Tubes System installed so that the values can be compared correctly.

1. Go to Diagnostic test>5. Scan Axis Menu>5.1 Scan Axis Test.
2. The Front Panel will display the various electrical subsystems being initialized in order to perform the test, if there is a failure at this point the Front Panel will display a system error, troubleshoot the system error using Chapter 3: System Error codes.
3. After initializing the following message will display on the Front Panel.

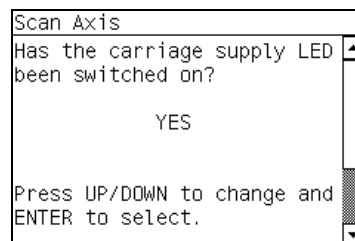

4. Open the Window, position your head as close as possible to the platen in order to check if the Carriage power light is ON (a very dim green light on the carriage PCA). Select **Yes** or **No** by using the **Up** and **Down** keys and press **OK** to confirm your selection.

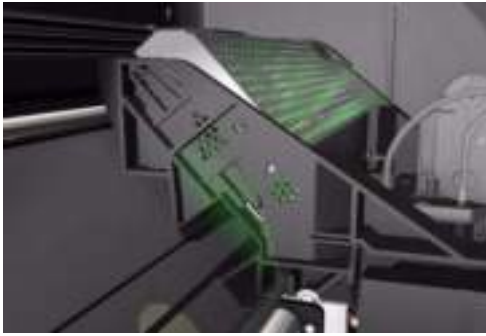

NOTE: To be able to see the LED, you have to place your head very close to the Platen but if you are not comfortable doing that you should remove the Right Cover before starting the test.

If you select **No** at this point, the Front Panel will display system error code **02.1:10** ⇒ see page 79. Check also system error code **11:10** ⇒ see page 81

If you select **Yes**, then the Front Panel will display:

- Booting up the Carriage.

If there is a failure at this point, the Front Panel will display system error code **02.1:10** ⇒ see page 79. Check also system error code **11:10** ⇒ see page 81 or system error code **01.1:10** (refer to page 78).

Unit Hangs Up - If no system error code is displayed on the Front Panel but the Printer hangs up and the last message on the Front Panel is "Booting up the Carriage" it means that the Carriage ASIC could not be detected. Troubleshoot this problem in the same way as if system error code **02.1:10** had displayed ⇒ see page 79.

5. Once the Carriage is booted up, the Service Station will be prepared so that the Carriage can be moved to a safe position. During this process, the following information will be displayed on the Front Panel:

- Starting SVS Motor.

If there is a failure at this point, the Front Panel will display system error code, for more information on troubleshooting this error code, refer to page 73. In addition the Service Station Test can be performed to try clear the SE, refer to page 163.

Unit Hangs Up - If no system error code is displayed on the Front Panel but the Printer hangs up and the last message on the Front Panel is "Starting SVS Motor" it means that the SVS Motor could not be initialized. Troubleshoot this problem in the same way as if system error code **21:12** had displayed.

6. The Printer will program the duty cycle for the PWM test for the Scan-Axis Movement and leave it disabled and the following information will be displayed on the Front Panel:

- Preparing SVS
- Prog slow PWM scan.
- Moving carriage middle.
- Prog fast PWM scan.

If there is a failure at this point, the Front Panel will display system error code **01.0:10** ⇒ page 78.

7. The Carriage will be moved to the middle of the Center Platen. If there is a failure in moving the Carriage, the Front Panel will display system error code **01.0:10** ⇒ page 78.
8. The printer will now check that it can read the Encoder Strip. When the following message displays on the Front Panel, open the Window and press the **Up** key to move the Carriage to the left and the **Down** key to move the Carriage to the right. Make sure that you move the Carriage in both directions and check that the Carriage actually moves when a key is pressed.

```

Scan Axis
Checking encoder readings.
Please keep out from platen
zone and press
UP(left)/DOWN(right) to
move the carriage.

Remaining movements: 10
Last movement: 0 eu

```

If there is a failure at this point, the Front Panel will display system error code **01.0:10** ⇒ page 78. If the Carriage only moves in one direction, troubleshoot the problem as system error code **01.1:10** ⇒ page 78.

9. At the end of 10 Carriage movements, the Front Panel will display the maximum and minimum length (in encoder units) of the 10 movements and the overall average.

```

Scan Axis
Max,Min mov: 990,838 eu
Avg mov: 901 eu
There is encoder feedback.

Encoder seems to be OK.

Press any key to continue.

```

If Carriage movement has not been detected or if Carriage movement was very short, the Front Panel will ask you “Did the motor move?”. If the answer is **Yes** (the Carriage had moved) press **OK**. If the answer is No (the Carriage had not moved) press the **Back** key.

If you select **No** (the Carriage had not moved), the Front Panel will display system error code **42:10** ⇒ page 102. Check also system error code **01.1:10** ⇒ page 78 or system error code **01.0:10** ⇒ page 78.

If you select **Yes** (the Carriage had moved), the Front Panel will display a system error code. Check also system error code **11:10** ⇒ page 81 or system error code **01.0:10** ⇒ page 78.

If any max. or min. movement length is outside the $\pm 20\%$ average, then this warning message will be displayed on the Front Panel “Some movements out of avg. $\pm 20\%$ range: Intermittent movements. PWM test needed”. This warning means that there is a mechanical problem in the Printer (Encoder Strip, friction, Carriage Belt, Slider Rod, etc...). Press any key to continue with the PWM test.

10. The Printer will now start to initialize the Scan-Axis servo and the Front Panel will display the following information:

- Starting Carriage Motor.
- Off/On Carriage Motor.
- Doing a right side bump.
- Doing a left side bump
- Exit bump position.

If there is a failure at this point, the Front Panel will display system error code **86:01** ⇒ see page 114.

11. The Printer checks the complete length of the Scan-Axis and displays the result on the Front Panel. Depending on the printer size, length has to be between:
 - **1158629** and **1164616** for the 42inch
 - **1507858** and **1513844** for the 60inch

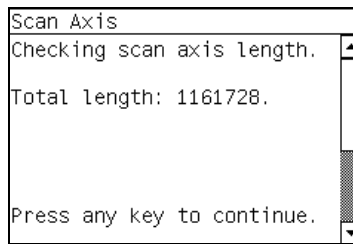

If it is shorter, it means that there is an obstacle blocking the Scan-Axis path and the Front Panel will display a system error code.

If the length is longer, it means that the carriage has a datum broken or the Carriage Stopper is not installed.

12. The Printer will now check the Scan-Axis PWM and the following information will be displayed on the Front Panel:
 - Starting Scan Axis.
 - PWM test.

If there is a failure at this point, the Front Panel will display a system error code.

13. The Printer will test the PWM at 61 ips and display the results on the Front Panel.

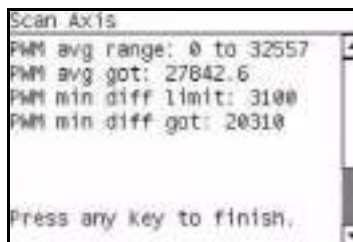

If some of the results are incorrect, the Front Panel will show "High Friction". Depending on the actual results received, the following should be done:

- If **PWM avg got** is more than 32557 and **PWM min diff got** is less than 3100 then there is high friction along the Scan-Axis. In this case you should:
 - Clean the Slider Rods and Apply Oil along the complete axis of the Slider Rods. After applying the Oil, perform the test again.
 - Check that the Carriage Belt is installed correctly.
- If **PWM min diff got** is less than 3100 but **PWM avg got** is less than 32557 then there is a problem in the Scan-Axis. In this case you should:
 - Check that the Encoder Strip is clean. If necessary, clean Encoder Strip using a damp cloth.
 - Check that the Ink Supply Tubes and Trailing Cable are installed correctly.

If there is a failure processing the PWM results, the Front Panel will display system error code **86:01**. In this case try repeating the test again.

14. Once the test is completed, OK will be displayed on the Front Panel and then you will be prompted to press any key to shut down the Printer.

6. Carriage Menu

6.1 Carriage PCA

Procedure

1. Go to Diagnostic test>6. Carriage Menu>6.1 Carriage PCA.

Description

This test performs specific routines on the Carriage PCA to check for any problems. If a failure is detected, the printer will display a system error code which can be used to troubleshoot the problem.

6.2 Color Sensor

Description

The purpose of this test is to troubleshoot an error with to the Color Sensor Test. The test checks the values measured by the sensor and compares them to what is expected, if the values are different the test is failed.



NOTE: We do not recommend using this test to measure the white of media, as there is a high risk of a jam occurring due to the vacuum being turned off, use the test color Sensor test shown on page 193.

Procedure

1. Go to Diagnostic test>6. Carriage Menu>6.2 Color Sensor Test.
2. The Front Panel will display the various electrical subsystems being initialized in order to perform the test, if there is a failure at this point the Front Panel will display a system error, troubleshoot the system error using Chapter 3: System Error codes.

If the SOL is disabled, the Front Panel will ask you if you want to enable the SOL, select Yes.

```
Colormeter
SQL Disabled.
Do you want to enable?
      YES
Press UP/DOWN to change and
ENTER to select.
```

3. The following message is displayed on the Front Panel, press any key to continue.

```
Colormeter
Starting ColorSensor.
Starting ColorSensing.
Reading SQL status.
Enabling SQL.
SQL enable/disable OK
Press any key to continue.
```

4. The Color Sensor information is read and the following message is displayed on the Front Panel, press any key to continue.

```
Colormeter
-----
FW Revision.  v4.0000
Sensor Type.   002
Serial Number. 400
Mfg Date.     0320

      000
Press UP/DOWN to change and
ENTER to select.
```

5. The Printer will read the Red Reference and the Front Panel will display the following messages:
 - Starting ColorSensor...
 - Starting ColorSensing
 - Reading SOL Status
 - Reading Registers
 - Switching on fans
 - Performing Calibration...
 - Reading Red Reference
6. The following message is displayed on the Front Panel, raise the Media Lever, load paper, lower the Media Lever, and press any key to continue.

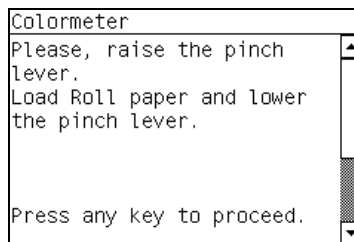

Be careful with the higher risk of a paper jam during this procedure.

7. The Front Panel then displays the deltaE value, press any key to continue.

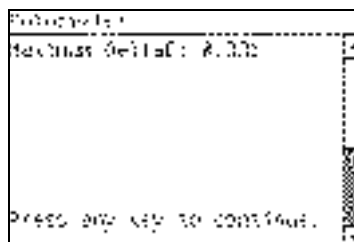

8. Once the test is completed, OK will be displayed on the Front Panel.



NOTE: If the customer reports color issues even through the test has passed, perform the Color Spectrophotometer test on page 193.

6.3 Line sensor

Description

The test checks the communication between the Line sensor and the Line sensor NVM.

Procedure

1. Go to Diagnostic test>6. Carriage Menu>6.3 Line Sensor.
2. The printer retrieves the Carriage Sensors PCA revision and displays it on the Front Panel.

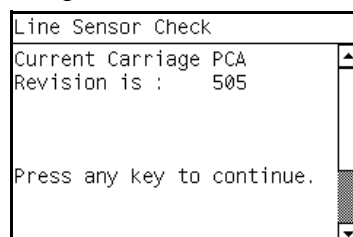

3. Press any key to continue.
4. The printer checks that the Line Sensor NVM reads and writes correctly. To do this, the printer temporarily writes a new serial number on the line sensor NVM then reads the new serial number to verify that the change was made. The printer retrieves the line sensor serial and part numbers and displays them on the Front Panel.

```

Line Sensor Check
Current Line Sensor values
are:
SERIAL-NUMBER: LNV38081680A
MODEL-NUMBER : 1271
Press any key to continue
  
```

5. Press any key to finish the test.

7. Service Station

7.1 Shuttle Close Loop

Description

This test checks the connection and functionality of the shuttle and the Service station motor. The Service Station shuttle is the moving tray on which the Printhead Cleaner Maintenance Cartridge is held.

Procedure

1. Go to Diagnostic tests>7. Service Station>7.1 Shuttle Close Loop.
2. The following screen is displayed. Manually move the Service Station to the front to the front position.

```

Shuttle - Close Loop
Please move the svs to the
front position
Press any key to continue
  
```

3. The front panel displays the following message, confirm that you have moved the Service Station, press OK.

```

Shuttle - Close Loop
Please move the svs to the
front position
Press any key to continue
  
```

4. Push the Service Station back a little to the rear, but not all the way, press OK.

```

Shuttle - Close Loop
Move the SVS a little
towards the Rear Position
Press OK to confirm and
continue
/ CANCEL to abort
  
```

5. Pull the Service Station a little towards the front of the printer, but not all the way, and press OK.

```
Shuttle - Close Loop
Move the SVS a little
towards the Rear Position

Press OK to confirm and
continue
/ CANCEL to abort
```

6. Move the Carriage Assembly to the middle of the Scan axis, and press OK.

```
Shuttle - Close Loop
Open the window, uncap the
carriage and move it to the
center of the scan axis
to assure it will not
interact with the svs

Press OK to confirm and
continue
```

The front panel displays the following message.

```
Shuttle - Close Loop
-----
Programming the duty cycle
moving service station
later
```

7. If the Service Station has moved automatically to the front of the printer press OK.

```
Shuttle - Close Loop
Confirm that SVS motor is
correctly installed in the
front position

Press OK to confirm and
continue
/ CANCEL to abort
```

The front panel displays the following message.

```
Shuttle - Close Loop
-----
Performing the advance
error test. .
```

8. The front panel displays the results of the test in encoder units.

```
Shuttle - Close Loop
Service Station's length
range:54870 to 56730 eu
Service Station's length
got: 55595 eu

Press any key to continue.
```

9. Close the window and press any key to finish the test.

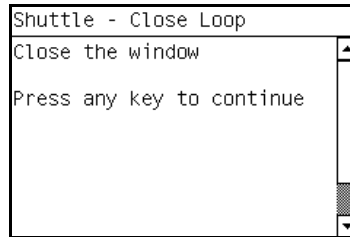

7.2 Drop Detector Test

Description

The purpose of this test is to check the connection and functionality of the Drop Detector by testing to see if it correctly detects the beam of light used when it's checking the Printhead.

Procedure

1. Go to Diagnostic tests>7. Service station>7.2 Drop Detector Test.
2. The printer checks that the Drop Detector is functioning correctly.

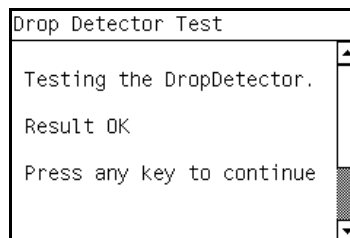

3. If there is a communication error, the following screen is displayed.

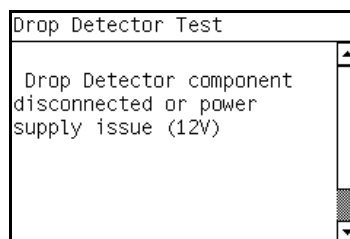

If this occurs check the cables and connections from the Drop Detector, if everything is connected correctly, replace the Drop Detector ⇒ page 377.

4. If there is an obstruction in the light beam of the Drop Detector, the following message is displayed.

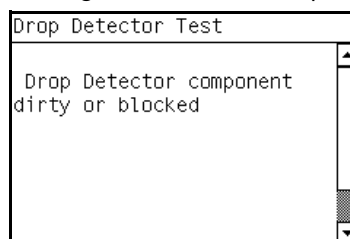

Try to clear the obstruction, if this cannot be done replace the Drop Detector ⇒ page 377.

7.3 Web Wipe Motor

Description

The purpose of this test is to check the functionality of the Web Wipe Motor and the connection with the Printmech. If a failure is found the appropriate system error is displayed, which can be used to troubleshoot the issue.

Procedure

1. Go to Diagnostic tests>7. Service station>7.3 Web Wipe Motor.
2. The Printer will now start to initialize the Web Wipe Motor test and the Front Panel will display the following information:
 - Starting Subsystems....
3. The following message is displayed, press ok to continue.

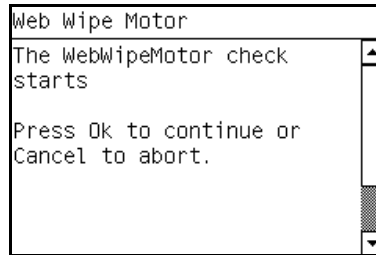

- Checking the WebWipeMotor....
4. At the end of the test press OK to end the test and shut down the printer.

7.4 Primer

Description

The purpose of this test is to check the connection and functionality of the Primer assembly. The test involves selecting a Printhead to prime a specified Printhead.

Procedure

1. Go to Diagnostic tests>7. Service station>7.4 Primer Test.
2. The Front Panel will display the various electrical subsystems being initialized in order to perform the test, if there is a failure at this point the Front Panel will display a system error, troubleshoot the system error using Chapter 3: System Error codes.
3. The following message is displayed, select the pen number (0 to 5) by using the **Up** and **Down** keys and press **OK** to confirm your selection.

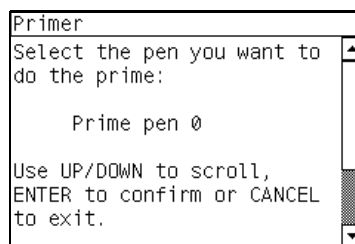

- 0: C-Lc
- 1: C-Lc
- 2: Y-B
- 3: Y-B
- 4: M-Lm
- 5: m-Lm

4. The Printer will prime the selected pen and the Front Panel will display the following messages:
 - Setting pens operational.
 - Preparing fluid manager.
 - Priming...
 - Terminating fluid manager.
 - Allowing pens not operational.

If there is a failure at this point, the Front Panel will display the corresponding error message (**Error: Setting Pens operational** or **Error: Allowing pens not operational**).

5. Once the test is completed, OK will be displayed on the Front Panel.

8. Heating and Curing

8.1 Heating

Description

The Heating diagnostic test enables the onsite engineer to check the performance of the heaters in the Dryer Assembly. The following parts are tested:

- The heaters in the Dryer Assembly.
- The complete servo system.

In order for the test to run, there must be media loaded in the media path.



NOTE: In order to obtain an accurate test of the Dryer heating system, the printer must be in a stable temperature condition.

Procedure

1. Go to Diagnostic tests>8. Heating and Curing>8.1 Heating Test.
2. The following message is displayed, confirm there is media loaded.

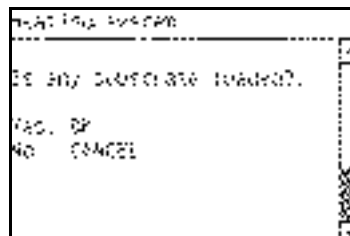

3. The printer displays the current temperature detected by the temperature sensor and checks that the temperature is stable. If the readings are not immediately stable, the printer turns on the vacuum and the fans and checks again for one minute (up to 4 times) before displaying a failure.
4. The front displays the following message. Open the window and press OK.

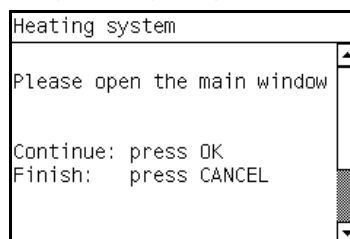

5. The front panel displays the following message.

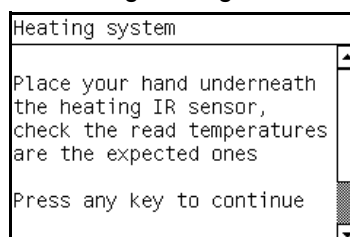

6. Place your hand under the temperature sensor and check that the temperature detected and displayed on the front panel changes appropriately.

If the display does not react to the change in temperature, press cancel and check the connections and cables of the Curing IR sensor, if everything is connected correctly replace the Curing IR sensor ⇒ page 510.

7. If the temperature changes correctly, press **OK** to continue.
8. The front panel displays the following screen, close the window and press Ok.

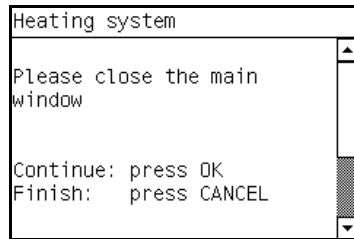

9. The printer sets a target temperature of 45C and tries to achieve and sustain the target temperature. In order to achieve this, the closed loop system must work correctly.

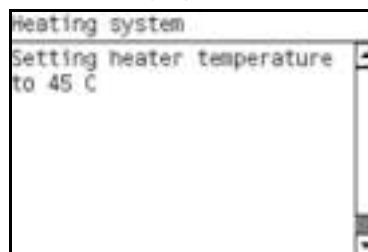

10. The printer heats up the print zone to the target temperature, and maintains it there until Ok is pressed.

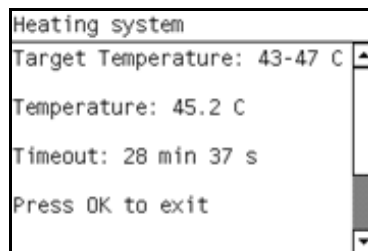

11. Press OK to finish the test, some extra time will now be required while the printer cools down.

8.2 Curing

Description

The Curing diagnostic test enables the onsite engineer to check the performance of the heaters in the Curing Module Assembly. The following parts are tested:

- The heaters in the Curing Assembly.
- The complete servo system.

In order for the test to run, there must be media loaded in the media path.



NOTE: In order to obtain an accurate test of the Curing heating system, the printer must be in a stable temperature condition.

Procedure

1. Go to Diagnostic tests>8. Heating and Curing>8.2 Curing Test.

- The following message is displayed, confirm there is media loaded.

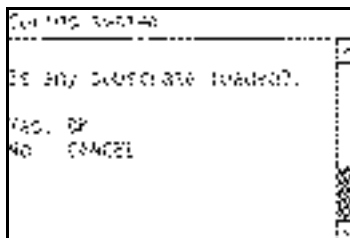

- The temperature is detected and checked that it is stable.
- The following message is displayed, remove the Curing IR Sensor from its place in the printer, but do not disconnect it. Press Ok.

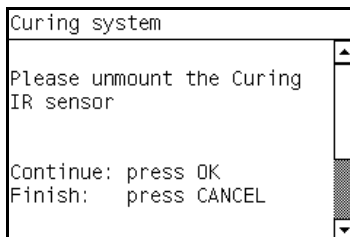

- Point the Curing IR temperature sensor at your hand and check that the temperature changes.

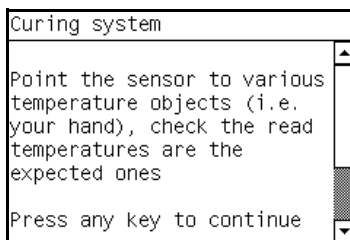

- Press **OK** to continue or **Cancel** if the value did not change or is not as expected.

The printer sets a target temperature of 50C.

The printer heats up the curing zone to the target temperature, and maintains it there until you press OK.

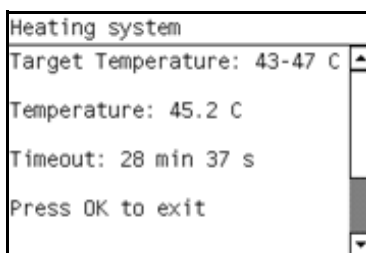

- Press OK to finish the test. Some extra time is required for the printer to cool down.

8.3 Heating (Dryer) IR Sensor

Description

This test checks the connection and functionality of the Dryer IR Temperature Sensor.

Procedure

- Go to Diagnostic tests>8. Heating and Curing>8.3 Heating IR Sensor.

- The following message is displayed, confirm there is media loaded.

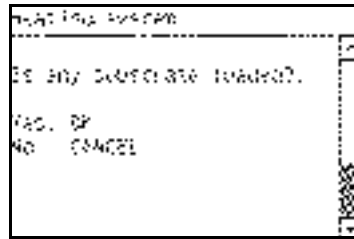

- The printer displays the current temperature detected by the temperature sensor and checks that the temperature is stable. If the readings are not immediately stable, the printer turns on the vacuum and the fans and checks again for one minute (up to 4 times) before displaying a failure.
- The front displays the following message. Open the window and press OK.

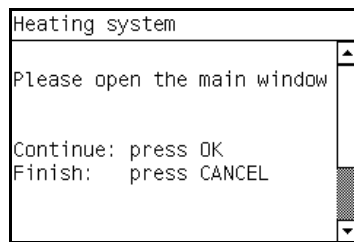

- The front panel displays the following message.

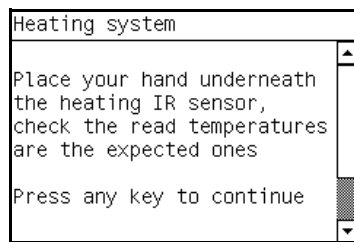

- Place your hand under the temperature sensor and check that the temperature detected and displayed on the front panel changes appropriately.

If the display does not react to the change in temperature, press cancel and check the connections and cables of the Dryer IR sensor, if everything is connected correctly replace the Dryer IR sensor ⇒ page 496.

- If the temperature changes correctly, press **OK** to continue.
- The front panel displays the following screen, close the window and press Ok to finish the test.

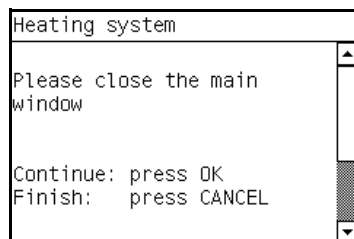

8.4 Curing IR Sensor

Description

This test checks the connection and functionality of the Curing IR Temperature Sensor.

Procedure

- Go to Diagnostic tests>8. Heating and Curing>8.4 Curing IR Sensor.

- The following message is displayed, confirm there is media loaded.

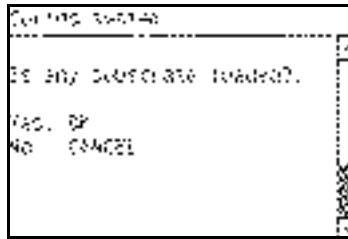

- The temperature is detected and checked that it is stable.
- The following message is displayed, remove the Curing IR Sensor from its place in the printer, but do not disconnect it. Press Ok.

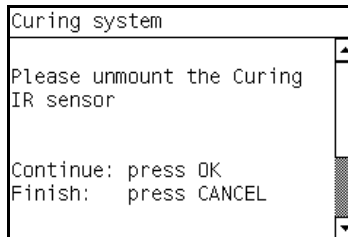

- Point the Curing IR temperature sensor at your hand and check that the temperature changes.

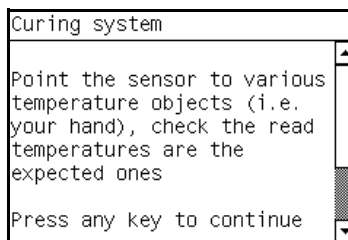

- Press **OK** to continue to finish the test or **Cancel** if the value did not change or is not as expected.

8.6 Heating Resistance

Description

This test must be used to introduce the steady and burst dryer resistors values whenever the Dryer Resistors are replaced.

Procedure

- Go to Diagnostic tests>8. Heating and Curing>8.6 Heating Resistors.
- The following message is displayed on the front panel, use the up and down arrows to change the resistor value to match with the resistor value of the 'Steady' resistor. This value is provided with the part from the factory. Press enter when finished.

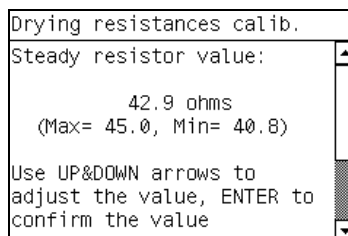

- The following message is displayed on the front panel, use the up and down arrows to change the resistor value to match with the resistor value of the 'Burst' resistor. This value is also provided with the part from the factory. Press enter when finished.

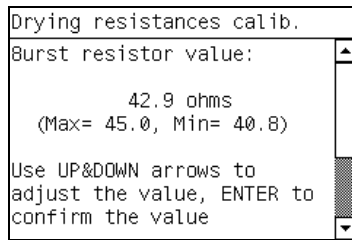

- Confirm that the values have been correctly entered and press the OK key.

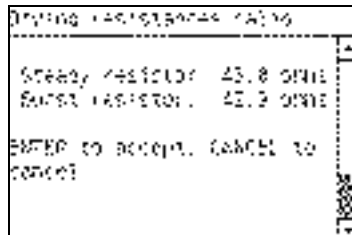

- Press enter to finish and shut down the printer.

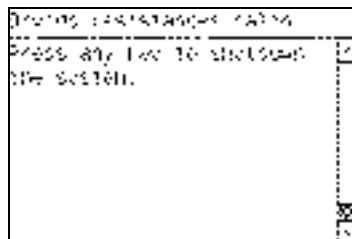

The resistor values will come with the service part from the factory. If for any reason they are not available, measure the values from the Power Control PCA 5 pin connector with a multimeter.

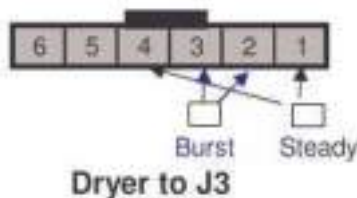

In the table shown below are the limits of the resistor values, these can also be used if the values are not available with the part.

Temperature	Filament	Heater/Dryer		Upper Spec	Lower Spec
		Value	Tolerance		
60°	Filament	CH956-60171			
	Steady	27.0	+5%	28.4	25.7
	Burst	40.6	+5%	42.7	38.6
42°	Filament	CH956-60049			
	Steady	31.1	+5%	32.7	29.6
	Burst	41.3	+5%	43.4	39.2
60° Japan	Filament	CQ162-60001			
	Steady	27.0	+5%	28.4	25.7
	Burst	29.3	+5%	30.7	27.8

9. Cover sensor test

9.1 Cover sensor test

Description

The printer checks the functionality of the sensors of the covers.

Procedure

1. Go to Diagnostic tests>9. Cover sensor test>9.1 Cover/Switch sensor.
2. The Printer will initialize the sensors
3. The Front Panel will display the various electrical subsystems being initialized in order to perform the test, if there is a failure at this point the Front Panel will display a system error, troubleshoot the system error using Chapter 3: System Error codes.
4. Before starting to test the sensors, the following message will be displayed to prompt the user to set the sensors to the test default positions. Press any key to continue:

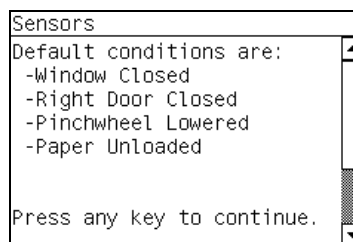

5. The Window Sensor will be tested first. When the following message is displayed on the Front Panel, open the Window and press any key to continue.

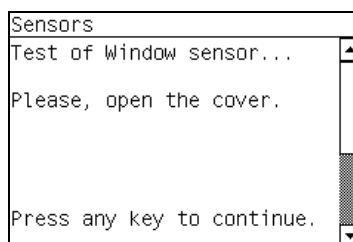

6. If the Window Sensor passes the test, the following message is displayed on the Front Panel. Close the Window and press any key to continue.

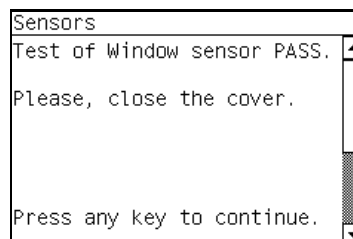

If the Window Sensor fails the test, the Front Panel will display system error code **51:10** ⇒ page 107.

7. The Maintenance Cartridge Door Sensor will be tested next. When the following message is displayed on the Front Panel, open the Maintenance Cartridge Door Sensor and press any key to continue.

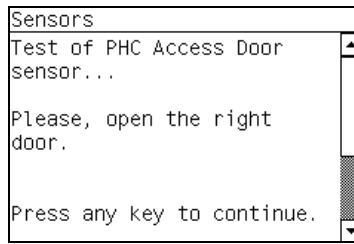

```
Sensors
Test of PHC Access Door
sensor...

Please, open the right
door.

Press any key to continue.
```

8. If the Maintenance Cartridge Door Sensor passes the test, the following message is displayed on the Front Panel. Maintenance Cartridge Door Sensor and press any key to continue.

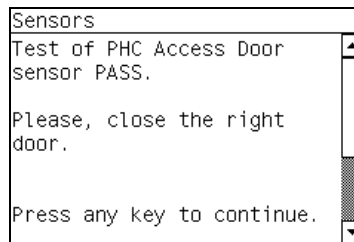

```
Sensors
Test of PHC Access Door
sensor PASS.

Please, close the right
door.

Press any key to continue.
```

If the Maintenance Cartridge Door Sensor fails the test, the Front Panel will display system error code **51.1:10** ⇒ page 107.

9. The Media Lever Sensor will be tested next. When the following message is displayed on the Front Panel, raise the Paper Lever and press any key to continue.

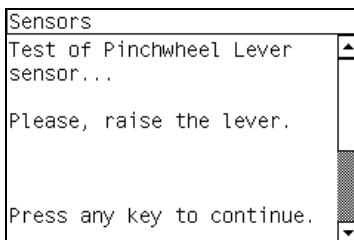

```
Sensors
Test of Pinchwheel Lever
sensor...

Please, raise the lever.

Press any key to continue.
```

10. If the Media Lever Sensor passes the test, the following message is displayed on the Front Panel. Lower the Paper Lever and press any key to continue.

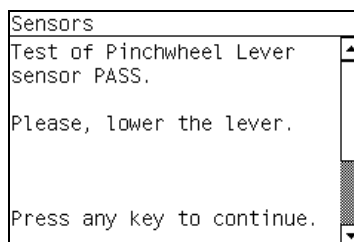

```
Sensors
Test of Pinchwheel Lever
sensor PASS.

Please, lower the lever.

Press any key to continue.
```

If the Paper Lever Sensor fails the test, the Front Panel will display system error code **54:10** ⇒ page 108.

11. The Media Sensor will be tested next. When the following message is displayed on the Front Panel, raise the Media Lever, load paper, lower the Media Lever, and press any key to continue.

```
Sensors
Test of Paper sensor...
Please, raise the lever,
load the paper and lower
the lever.
Press any key to continue.
```

12. If the Media Sensor passes the test, the following message is displayed on the Front Panel, raise the Media Lever, unload paper, lower the Media Lever, and press any key to continue.

```
Sensors
Test of Paper sensor PASS.
Please, raise the lever,
remove the paper and lower
the lever.
Press any key to continue.
```

If the Paper Lever Sensor fails the test, the system error **53:10** is displayed ⇒ page 108

13. The front panel displays the following message, check that there is nothing in the carriage path and press any key.

```
Sensors
Media jam sensor test.
Please make sure nothing is
blocking the carriage path.
Press any key to continue.
```

If there is an error with the Media Jam sensor, the system error **82:01** is display ⇒ page 114.

14. If the test passes OK the following message is displayed on the Front Panel, press any key to continue.

```
Sensors
First test successful.
Press any key to proceed to
manual test.
```

15. The following message is displayed. Make sure the parts inside the printer are not too hot. Cover the reflector on the left side of the carriage and at the same time press any key to continue. This verifies that the light going to the sensor is from the reflector and not from another light source.

```
Sensors
Please open the window,
cover the media jam
reflector on the carriage
with your hand and press
any key.
CAUTION: Heating module may
be hot. Do not touch it.
```

If there is an error with the Media Jam sensor, the system error **82:01** is display ⇒ page 114.

16. If the test passes OK the following message is displayed on the Front Panel, press any key to continue.

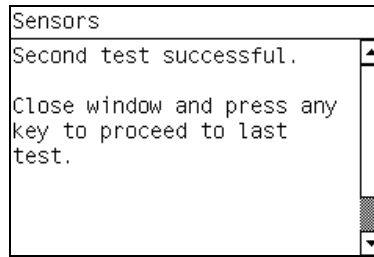

17. The following message is displayed. The carriage assembly moves along the Carriage path testing the Media Jam Sensor as it goes along the scan axis.

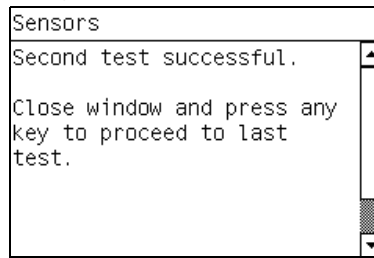

If there is an error with the Media Jam sensor, the system error **82:01** is display ⇒ page 114.

18. If the test passes OK the following message is displayed on the Front Panel, press any key to finish.

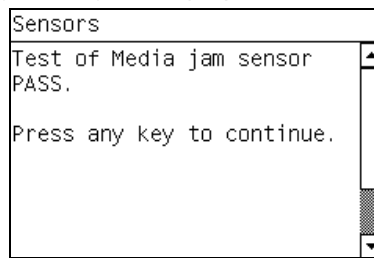

10. Diagnostic Utilities

10.1 Force Normal Boot

Description

This selection must be made after you no longer want the printer to constantly boot in diagnostic mode. After this selection is made the printer will boot as normal

This feature is also included in the Service Menu.

Procedure

1. Go to Diagnostic tests>10. Diagnostic Utility Menu>10.1 Force Normal Boot.

The printer changes the configuration.

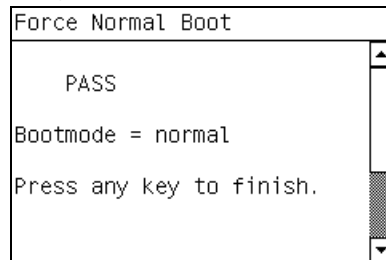

2. Press any key to finish.

10.2 Force Diagnostics Boot

Description

The Force Diagnostic Mode diagnostic utility allows you to reset the printer bootmode so that the printer will always start in diagnostic mode. This is useful if you will be performing multiple tests running from diagnostic mode.



NOTE: Once you force the printer to boot in diagnostic mode, in order to change the bootmode back again, you must perform the Force Normal Boot diagnostic utility, see previous utility.

This feature is also included in the Service Menu.

Procedure

1. Go to Diagnostic tests>10. Diagnostic Utility Menu>10.2 Force Diagnostic Boot.

The printer changes the configuration.

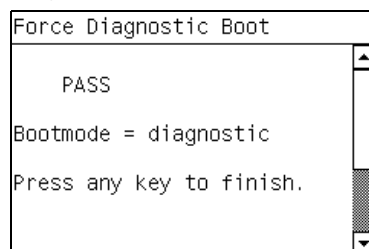

2. Press any key to finish.

10.2 Report Tests Version

Description

The Report Tests Version displays which version of the Diagnostic tests is installed in the Printer. This feature is also included in the Service Menu.

Procedure

1. Go to Diagnostic tests>10. Diagnostic Utility Menu>10.2 Report Tests Version.
2. The printer displays the diagnostic menu version.

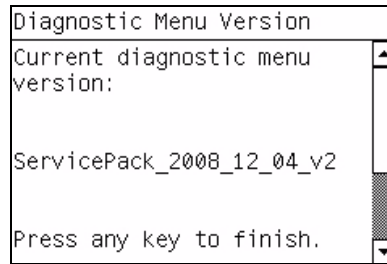

3. Press any key to finish the test.

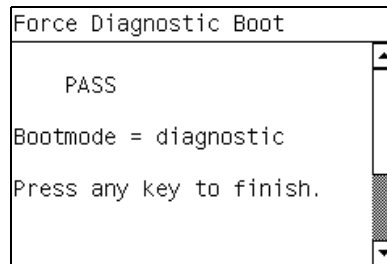

10.4 Enable/Disable Logs

Description

Enabling logs is a useful tool when troubleshooting any error with the printer when the cause of the error is not obvious, the printer can log all printer activity up until the error occurred, this can give clues as to the cause and solution to the error. Logs can also be sent via E-mail if the problem must be escalated to division for further analysis. This feature is also available in the Service Menu.

Procedure

1. Go to Diagnostic tests>10. Diagnostic Utility Menu>10.3 Enable/Disable Logs.
2. There is an option to enable/disable all of the traces or selected traces.

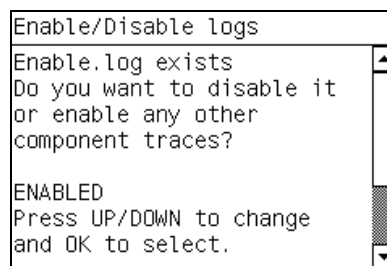

3. If 'enable' is selected, select the traces that you want enabled using the up and down arrows.

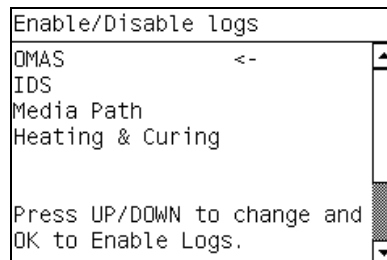

- When the trace is enabled, a message is displayed confirming the trace. Press any key.

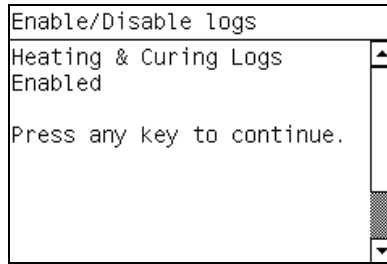

- Press any key to finish and shut down the system.

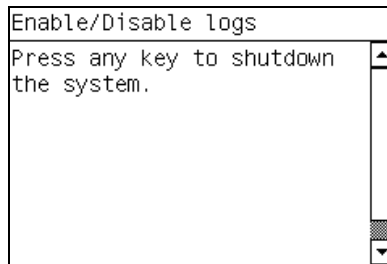

Emergency Firmware Upgrade

The following procedure can be used if the printer cannot be turned on in normal mode because of an error, or if the EWS has been disabled in the Front Panel. This procedure can only be performed when the printer is in the Service Utility Menu.

- Download the .plt file from the Customer Assurance website, save the file to a folder in the computer.
- Note the ip address of the printer, obtained from '2.6 IO Information'. When you are in the menu do not press any keys on the Front Panel because the printer will shut down.

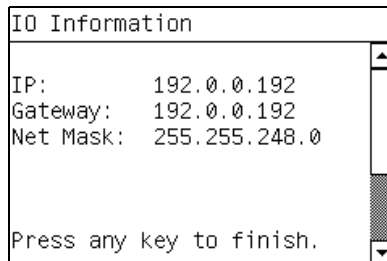

- Send the .plt file to the printer using an ftp connection. Example of ftp procedure:
 - Open a DOS window.
 - ftp <ip of the printer> If the 'time out' message is displayed, wait a few minutes and try again.
 - At the login and password press the enter keys, this will login as 'Anonymous'.
 - bin
 - put <filename.plt>

- f. Close the ftp connection and the printer will upgrade the firmware.

```
ftp> quit
C:\Users\josloper>ftp 192.0.0.192
> ftp: connect :Connection timed out
ftp> quit
C:\Users\josloper>ftp 192.0.0.192
> ftp: connect :Connection timed out
ftp> quit
C:\Users\josloper>ftp 192.0.0.192
Connected to 192.0.0.192.
220 FTP Server Ready
User (192.0.0.192:(none)):
331 Enter password.
Password:
230 Hewlett-Packard FTP Print Server Version 3.0.
Directory:      Description:
-----
PORT           HP Designjet L25500 42ia Printer
To print a file use the command put <filename> [portx]
or 'cd' to a desired port and use put <filename>.
230 User logged in.
ftp> bin
240 Type set to I. Using binary mode to transfer files.
ftp> put GC-CAL_B1_00_00.7_rwl40-x86-opt_E.plt
200 Port command successful.
150 Opening BINARY mode data connection.
226-Ready
226-Processing job.
226 Transfer complete.
ftp: 215798653 bytes sent in 62.562seconds 3449.348bytes/sec.
ftp> quit
```

Service Menu

- 1. Service Test and Utilities Menu ⇒ page 182
- 2. Image Quality Plots⇒ page 196
- 3. Inks On Substrate Test ⇒ page 199
- 4. Reset Life Counters ⇒ page 199
- 5. Service Calibration menu ⇒ page 201

These service utilities help you to service, maintain, and clean the printer. This section guides you through the service utility procedures and provides information about each utility.

Entering the Service Utilities Menu

- 1. Once the message “Ready” is displayed on the front-panel, scroll to the “Printer Setup Options” icon and press the **Enter** key.



- 2. For Call Agents who will request the user to perform certain Service Utilities, once inside the “Setup” menu, press the **Down** arrow key and the **Cancel** key together. You are now in the **Service Tools** Menu.



- 3. For On-Site Engineers, once inside the “Setup” menu, press the **Up** arrow key and the **Cancel** key together. You are now in the **Service Tools** Menu.



- Use the **Arrow** keys to scroll to the “Service Utilities” menu and press the **Enter** key.

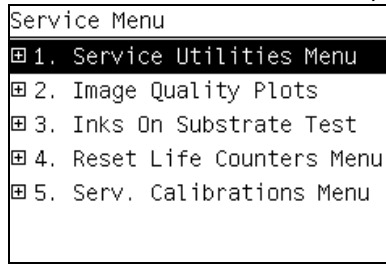

- Use the **Arrow** keys to scroll through the “Service Utilities” selections and press the **Enter** key to begin a specific operation when the required Service Utility is highlighted.

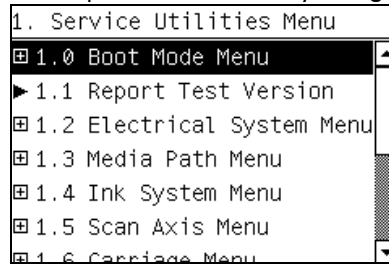

1. Service Tests and Utilities Menu

1.0 Boot Mode Menu

1.0.1 Force Diagnostic Mode

Description

The Force Diagnostic Mode diagnostic utility allows you to reset the printer bootmode so that the printer will always start in diagnostic mode. This is useful if you will be performing multiple tests running from diagnostic mode. This feature is also included in the Diagnostic Menu.



NOTE: Once you force the printer to boot in diagnostic mode, in order to change the bootmode back again, you must perform the Force Normal Boot diagnostic utility from Diagnostic menu, or if the printer is still in normal mode from the Service menu.

Procedure

- Go to Service Test Menu > 1.0 Boot Mode Menu > 1.0.1 Force Diagnostic Mode.
- The printer asks you to confirm that you want the printer to start in diagnostic mode.

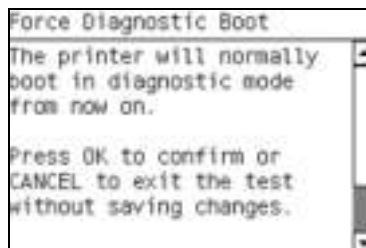

3. Press **OK** to change the bootmode. Press **Cancel** to make no changes and to exit.

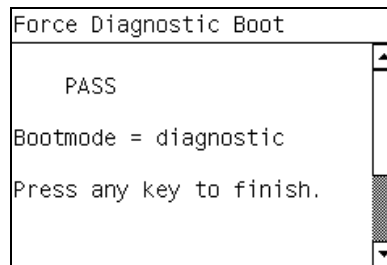

1.0.2 Force normal Mode

Description

This selection must be made after you no longer want the printer to boot in diagnostic mode. After this selection is made the printer will boot as normal. This feature is also included in the Diagnostic Menu.

Procedure

1. Go to Service Test Menu >1.0 Boot Mode Menu>1.0.2 Force Normal Mode.
2. The printer asks you to confirm.

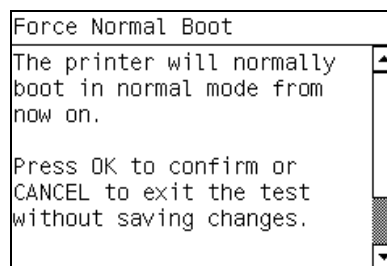

3. Press ok to change to the boot mode.

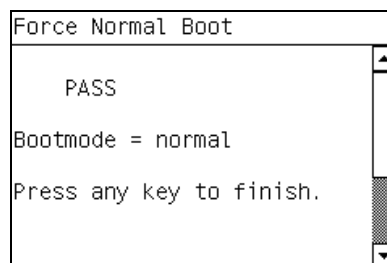

1.1 Report Tests Version

Description

The Report Tests Version displays the firmware and service menu version on the Front Panel. The format of this version number is GF_03_01_01_XX where **XX** = service menu version.

Procedure

1. Go to Service Test Menu >1.1 Boot Mode Menu.
2. The printer displays the service menu version.

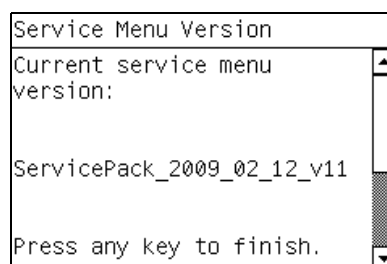

3. Press any key to finish.

1.2 Electrical System menu

1.2.1 Set Time and Date

Description

The purpose of this Service Utility is to set the printer time and date and the Real Time Clock of the Printer.

Procedure

1. Go to Service Test Menu > 1.2.1 Set Date and time.
2. The Printer displays the current time (HH:MM:SS) and date (MM:DD:20YY) and a space for you to enter the new time and date.

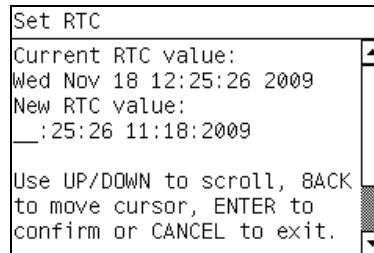

3. Use the **Up** and **Down** keys to go through the digits and press the **OK** key to go to the next digit. You can press the **Cancel** key at any time to exit the utility without making any changes.

Once the new time has been entered, the Front Panel displays the time that you have entered.

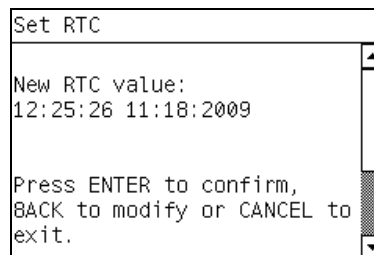

4. Press the **OK** key to confirm the time or the **Cancel** key to exit the utility without making any changes or the **Back** key to modify again.



NOTE: If the current RTC Clock cannot be set, it could indicate a possible Firmware error.

5. Once the new time has been set, the Front Panel asks you to restart the printer after exiting. Press any key to exit

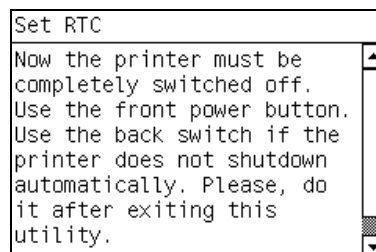

1.2.2 Enable/Disable Firewall

Description

The purpose of this Service Utility is to enable or disable the firewall of the printer.

Procedure

1. Go to Service Test Menu > 1.2.2 Enable/Disable Firewall.
2. The utility checks to see if the firewall is enabled or disabled, and then prompts you to enable or disable the firewall.

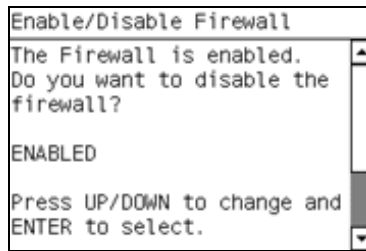

3. Use the **Up** and **Down** keys to choose to enable/disable and press the **OK** key to confirm your selection. If the utility exits correctly, OK is displayed on the Front Panel.

1.2.3. Enable/Disable Logs

Description

Enabling logs is a useful tool when troubleshooting any error with the printer when the cause of the error is not obvious, the printer can log all printer activity up until the error occurred, this can give clues as to the cause and solution to the error. Logs can also be sent via E-mail if the problem must be escalated to division for further analysis. This feature is also available in the Diagnostics Menu.

Procedure

1. Go to Service Test Menu > 1.2.3 Enable/Disable Logs.

The printer asks you if you want to enable or disable logs.

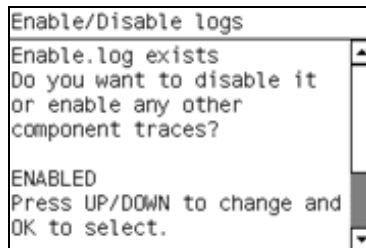

2. Select **Enable logs** or **Disable logs** and press **OK** to confirm.
3. If you are enabling logs, the printer asks you to select the component or subsystem you want to apply the changes to.

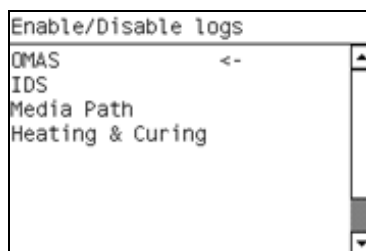

4. Select the component or subsystem and press **OK** to confirm.

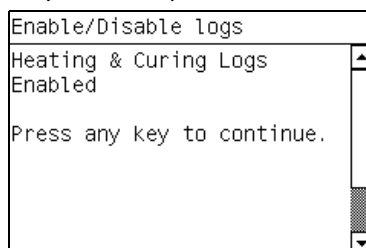

5. If the utility exits correctly, OK is displayed on the Front Panel.

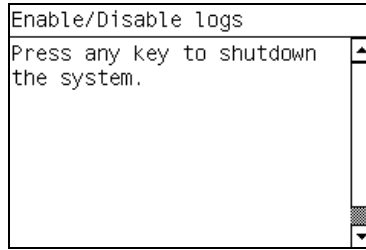

1.2.4 Input/Output

Description

The purpose of the IO information service utility is to test the hardware for the installed and active IO interfaces (Fast Ethernet, Gigabit Ethernet). The IO information service utility checks the hardware involved in every IO interface and the configuration portion in the firmware.

Procedure

1. Go to Service Test Menu > 1.2.4 Input/Output.
2. The front panel displays the following message, press enter to continue.

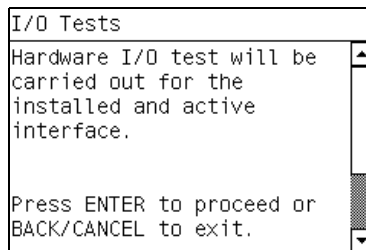

3. The front panel displays the following message.

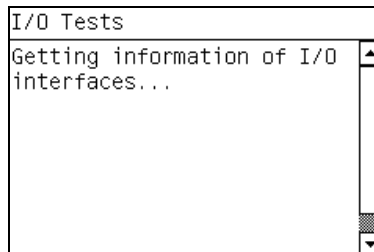

4. The front panel displays the following message.

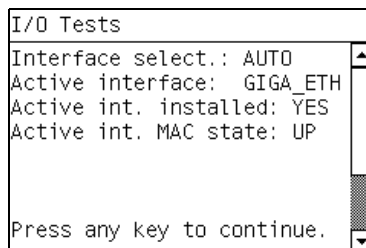

5. The front panel displays the following message.

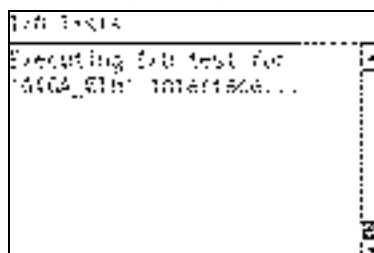

- The front panel displays the following message.

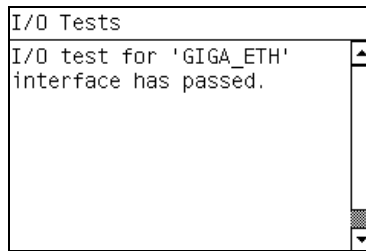

1.2.5 Set Serial Number

Description

The purpose of this Service Utility is to set the Serial Number and Part Number of the Printer.

Procedure

- Go to Service Test Menu > 1.2.5 Set Serial Number.
- The Printer will display the current Serial Number and the new Serial Number of the Printer. Use the **Up** and **Down** keys to go through the digits and press the **OK** key to go to the next digit. You can press the **Cancel** key at any time to exit the utility without making any changes.

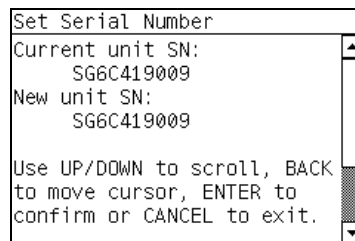

- Once the new Serial Number has been entered, the Front Panel will display the Serial Number and Model Number of the Printer. Press the **OK** key to confirm the Serial Number or the **Cancel** key to exit the utility without making any changes or the **Back** key to modify again.

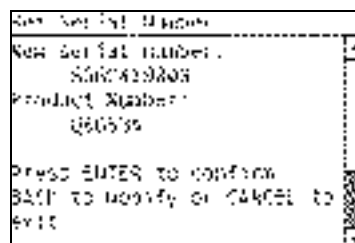

- If the utility exits correctly, OK will be displayed on the Front Panel.

1.2.6 Sleep Mode

Description

The purpose of this is to enable/disable the sleep mode so that the Printer is never switched Off automatically if not used for a certain period of time (one hour by default).

Procedure

- Go to Service Test Menu > 1.2.6 Sleep Mode.

- When the following message displays on the front panel, use the **Up** and **Down** arrow keys to either disable or enable the sleep mode. Press the **OK** or **Cancel** key to confirm the selection.

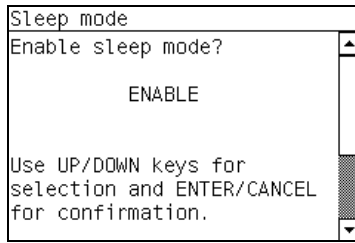

If the current sleep mode cannot be read, it could point to a possible Firmware error.

- Once the selection is confirmed, the Front Panel will display the new sleep mode state:

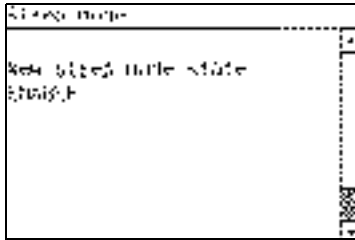

If the current sleep mode cannot be set, it could indicate a possible Firmware error.

- If the utility exits correctly, OK will be displayed on the Front Panel.

1.3 Media Path Menu

1.3.1 Turn Drive Roller

Description

The purpose of this is to rotate the Drive Roller in order to test it and perform maintenance cleaning.

Procedure



NOTE: Remove media before performing this operation.

NOTE: Open the window of the printer and activate the window sensor (using a piece of paper) before performing this service utility.

- Go to Service Test Menu > 1.3 Media Path Menu > 1.3.1 Turn Drive Roller.
- The Printer checks if media is loaded. If media is loaded, the Front Panel will display the following message. Unload the media and start again from **step 1**:

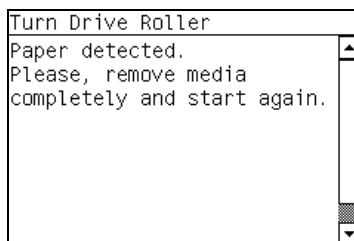

- The Drive Roller begins to turn slowly and the following message is displayed on the Front Panel:

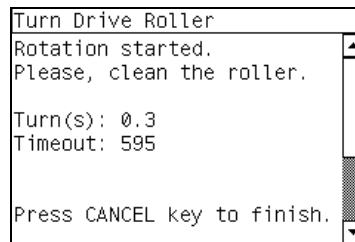

- Refer to the Cleaning Instructions on page 600.
- Once you have finished cleaning the Drive Roller and the Overdrive, press the **Cancel** key to exit.



NOTE: Please remember to remove the piece of paper from the window sensor before closing the window as this could damage the window and the sensor.

1.3.2. Enable/Disable OMAS

Description

The purpose of this Service Utility is to enable or disable the OMAS sensor to be able to measure and troubleshoot the influence of the OMAS sensor on image quality problems. Sometimes, disabling the OMAS sensor is recommended when the OMAS cannot detect the surface of the substrate. This could happen if the substrate is highly reflective or the media is very transparent. When the OMAS is disabled the substrate advance is controlled by the analog encoder on the main drive roller.

Procedure

- Go to Service Test Menu > 1.3 Media Path Menu > 1.3.2 Enable/Disable OMAS.
- The printer asks you if you want to perform this utility, select **Yes** and press **OK** to confirm your selection.

The printer displays the current OMAS state (enabled/disabled) on the Front Panel and asks you to select the new state for the OMAS sensor.

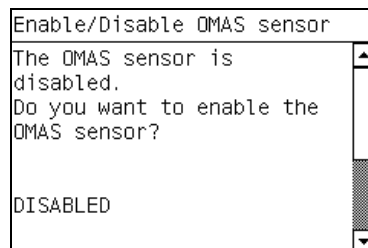

- Select enable or disable and press **OK** to confirm your selection.

1.3.3 OMAS Check

Description

The purpose of this Service Utility is to compare the functionality of the internal temperature Optical Media Advance Sensor (OMAS) and the external TOMAS sensor. If the values are not similar, perform "5.3.3 OMAS Temperature sensor Calibration" ⇒ page 211. This test also checks the functionality of the OMAS.

Procedure

- Go to Service Test Menu > 1.3 Media Path Menu > 1.3.3 OMAS Sensor Check.

- The front panel displays the following message, press the enter key to continue.

```
OMAS sensor check
Read temperatures using...
internal sensor: -5.0
external sensor: 22.0
Press OK to continue OR
CANCEL to exit.
```

- The front panel displays the results of the test.

```
OMAS sensor check
Photo average value : 102
Photo std dev value : 4
Press any key to finish.
```

- Press any key to finish.

1.4 Ink System Menu

1.4.1 Purge Tubes

Description

The purpose of this is to Prime the Tubes when the Ink Tubes are NOT new and they need to be re-primed or automatic priming was not completed correctly.



NOTE: Make sure that NEW Ink Cartridges are installed or that the ink volume remaining in the Ink cartridges is below 88% before starting to prime the tubes. If you do not comply, you will get a warning message.

Procedure

- Go to Service Menu > 1.4 Ink System Menu > 1.4.1 Purge Tubes.
- If the Ink Cartridges are not suitable for priming, the following message will display on the Front Panel. Replace the installed Ink Cartridges with Ink Cartridges that are new or contain less than 88% of ink. Press any key to finish the utility.

```
Prime Tubes
Some of the current ink
supplies are not valid for
purge (0 1 2 3 4 5 6 7).
Please, replace them by
valid cartridges for purge
and start again.
Press any key to finish.
```

- The front panel displays the following message, press ok to continue purging the tubes.

```
Prime Tubes
Ink Supply Tubes ready for
priming. Do you want to
Continue?
Press ENTER to continue or
BACK/CANCEL to exit.
```

- The front panel displays the following message, and then restarts in the purge process.

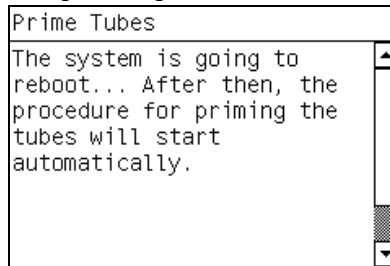

- Once the Printer has rebooted, the Front Panel will instruct you to open the Window and remove ALL the Printheads installed in the Carriage.

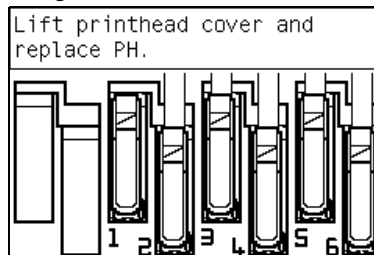

- Once ALL the Printheads have been removed, the Front Panel will instruct you to install the Setup Printheads into the Carriage.
- Once all the Setup Printheads are installed, the following message will display on the front panel. Close the carriage cover and close the window.

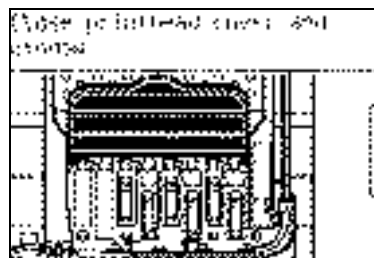

- The printer will begin to purge the tubes system.
- Once the tubes system has been purged, the following message will instruct you to open the Window:

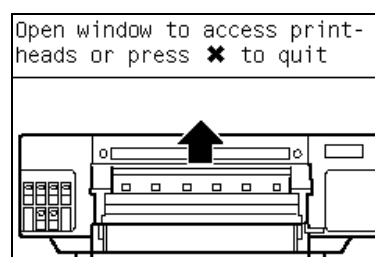

- Check that the setup printheads have some ink and continue.

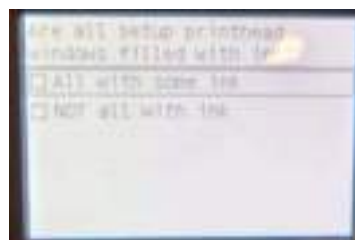

11. The printer will ask you to change the ink funnel and waste bottle, disregard this instruction, do not change any parts. Continue with the purge procedure, pressing the ok key to advance through the procedure, but without changing anything.
12. At the end of the procedure the printer will perform the Printhead Alignment procedure.

1.5 Scan Axis Menu

1.5.1 Force drop detection

Description

The purpose of this is to reset the nozzle health database so that all nozzles are assumed to be correct.

Procedure

1. Go to Service Menu > 1.5 Scan Axis Menu > 1.5.1 Force Drop Detection.
2. The printer asks you if you want to perform this utility. Use the **Up** and **Down** keys to select **Yes** or **No**. Press **OK** to confirm your selection. If you select **No**, the printer exits the utility.
3. The printer asks you to check that the ink is ready and all the pinch lever is closed.

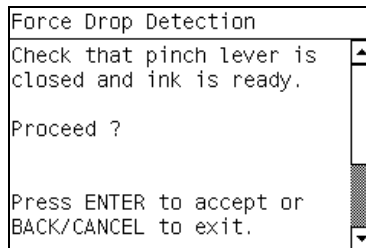

4. Check that the ink is ready, and the pinch lever is in the closed position. Press any key to continue, the following message is displayed.

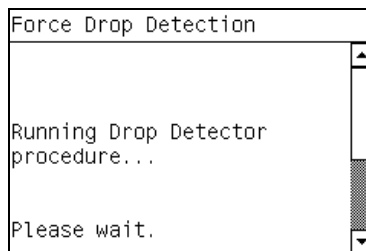

The printer performs a drop detection and displays the drop detector values on the Front Panel.

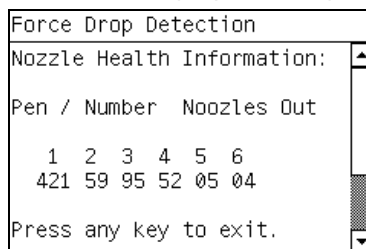

NOTE: The drop detector values for nozzles out should be below 150 nozzles per printhead. If they are not print the "2.4.1 Print test plot" and verify that this printhead has so many nozzles out. If the Printhead has many nozzles out, and it is causing banding, change the printhead. If the printhead is ok this would indicate an error with the drop detector. Perform the "5.5.2 Drop Detector Calibration and the "1.5.1 Force Drop detection" procedures.

5. Press **OK** to accept the values and pass the test or **Cancel** to reject the values and fail the test.

1.6 Carriage Assembly

1.6.1. Color Sensor (Spectrophotometer) Check

Description

The printer uses as a reference an HP Aqueous Media. Use the part number Q1273-60296 if you do not have any of this type of media available.

Procedure

1. Go to Service Menu >1.6 Carriage Assembly>1.6.1 Color Sensor Check.
2. The printer asks you to use HP Aqueous Media for this test, press any key to continue.

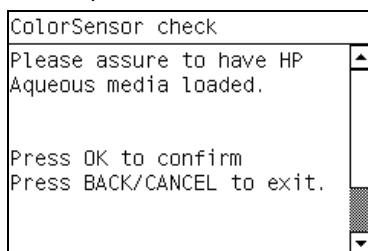

The printer tells you that it will begin to warm up the color sensor, press any key to continue

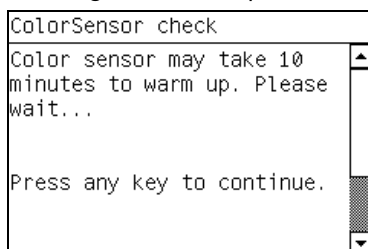

The printer warms up the Color Sensor for ten minutes, and displays the time remaining.

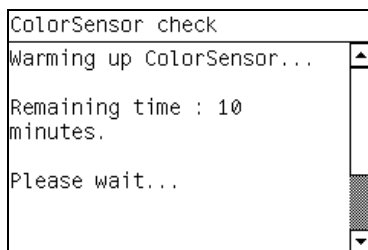

The printer performs the calibration.

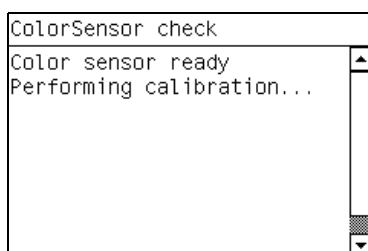

3. The results are displayed on the front panel., press any key to finish the test.

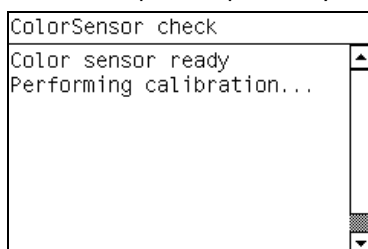

1.6.2 Replace Cutter

Description

The purpose of this Service Utility is to move the Carriage to a position where the Cutter can be replaced easily.

Procedure

1. Go to Service Menu >1.6 Carriage Assembly>1.6.2 Replace Cutter.
2. When the following message displays on the Front Panel, select Ok.

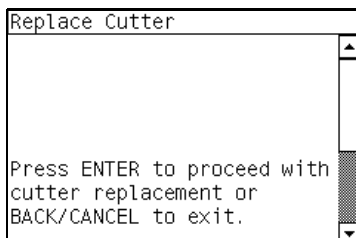

3. The Carriage will move to the Cutter replacement position and the following message will be displayed on the Front Panel. After a few seconds the Printer will begin to shutdown.

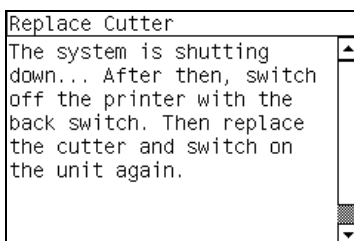

4. Before replacing the Cutter, make sure that you switch the Printer OFF from the rear.

1.7 Service Station

1.7.1. Prime Pen X

Description

The purpose of this is to prime a specific pen.

Procedure

1. Go to Service Menu >1.7 Service Station>1.7.1 Prime Pen X.
2. The following message is displayed on the Front Panel, select **OK**.

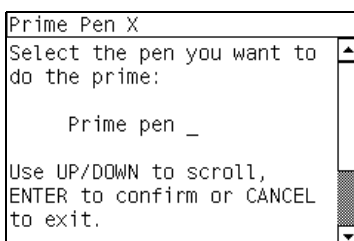

- Use the **Arrow** keys to select the Pen (0 to 7) that you want to prime and press the **OK** key.

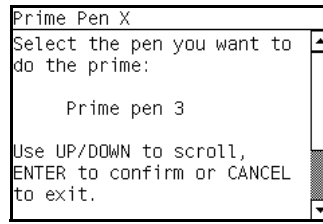

- The Printer will prime the selected pen and the Front Panel will display the following messages:

- Setting pens operational.
- Preparing fluid manager.
- Priming...
- Terminating fluid manager.
- Allowing pens not operational.

If there is a failure at this point, the Front Panel will display an error code, troubleshoot the error using the procedures in Chapter 3 System Error Codes.

- If the utility exits correctly, OK will be displayed on the Front Panel.

1.8 Heating and Curing

1.8.1 Heating and Curing Temperature Sensors

Description

The Heating and Curing Temperature utility displays the target temperature, current temperature detected by the temperature sensors, and the power currently applied.

Procedure

- Go to Service Menu > 1.8 Heating and Curing Menu > 1.8.1 Heating and Curing Temperature.
- The printer displays the current values read by the Temperature Sensors (heating/curing), press any key to finish the test.

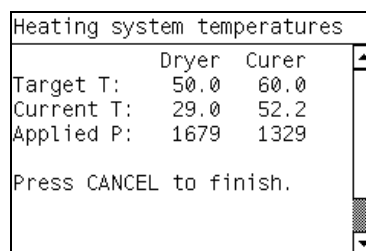

1.8.2 Enable Heating and Curing

Description

This setting enables you to disable the heating system of the printer. This setting is useful for example if you want to print a quick print to test the printer's functionality, but did not want to wait for the printer to heat up to the target temperature.

Procedure

- Go to Service Menu > 1.8 Heating and Curing Menu > 1.8.2 Enable Heating and Curing.

- To disable the Heating and Curing, select 'disable' using the up and down arrows and press the ok button.

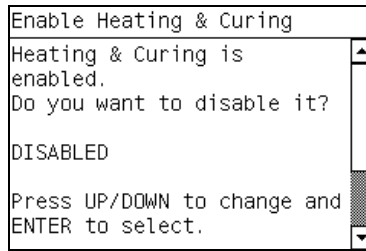

- If for any reason the printer is unable to disable the Heating and Curing, the following message is displayed, and the procedure will be cancelled.

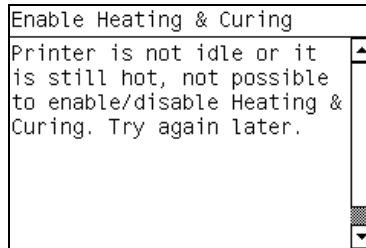

- If the printer is in the correct condition to be disabled, the following message is displayed.

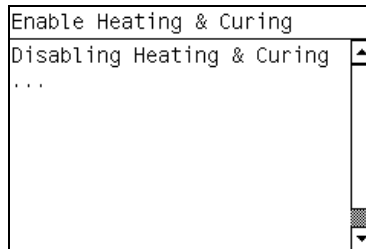

1.11 Show Test Messages

Description

Explains how to enter in to the diagnostics TLC mode

Procedure

- Go to Service Menu > 1.11 Show Test Messages.

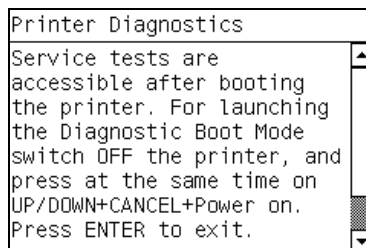

2. Image Quality Plots

2.1 Print ALL Plots

Description

The Print ALL Plots allows you to print at once all three diagnostic prints in order to diagnose an image quality defect. These are the Printhead Alignment, the Printheads Health and Substrate advance. Refer to chapter 5 for more details.

Procedure

1. Go to Service Menu >2. Image Quality Plots>Print ALL Plots.

2.2 Printheads Alignment Menu

2.2.1 Test Plot

Description

The Printhead Alignment Test Plot allows you to check the accuracy of the current printhead alignment. Refer to chapter 5 for more details.

Procedure

1. Go to Service Menu >2. Image Quality Plots>2.2 Printheads Alignment Menu>2.2.1 Test Plot

2.2.2 Advanced Test Plot

Description

The purpose of the Advanced Test Plot is to help you to visually check for any alignment problem in the printer. Refer to Chapter 5 for detailed information

Procedure

1. Go to Service Menu >2. Image Quality Plots>2.2 Printheads Alignment Menu>2.2.2 Advanced Test Plot

2.2.3 Automatic Printhead Alignment

Description

This Service Utility triggers an Automatic Printhead Alignment

Procedure

1. Go to Service Menu >2. Image Quality Plots>2.2 Printheads Alignment Menu>2.2.3 Automatic Printhead Alignment.

2.2.4 Manual Printhead Alignment Menu

2.2.4.1 Print Pattern

Procedure

1. Go to Service Menu >2. Image Quality Plots>2.2 Printheads Alignment Menu>2.2.4 Manual Printhead Alignment Menu>2.2.4.1 Print Pattern.

2.2.4.2 Manual Alignment Settings

Procedure

1. Go to Service Menu >2. Image Quality Plots>2.2 Printheads Alignment Menu>2.2.4 Manual Printhead Alignment Menu>2.2.4.2 Manual Alignment Settings.

2.3 Substrate Advance

2.3.1 Substrate Advance Adjustment

Procedure

1. Go to Service Menu >2. Image Quality Plots>2.3 Substrate Advance>2.3.1 Substrate Advance Adjustment.

2.3.2 Print Adjustment Plot

Description

The purpose of the Print Adjustment Plot is to help you in determining the advance offset in the printer with the current media loaded. This value has to be introduced to the RIP for adjusting the media advance.

Procedure

1. Go to Service Menu >2. Image Quality Plots>2.3 Substrate Advance>2.3.2 Print Adjustment Plot.

2.3.3 Reset Substrate Advance

Description

Resets the substrate advance offset set in the printer.

Procedure

1. Go to Service Menu >2. Image Quality Plots>2.3 Substrate Advance>2.3.3 Reset Substrate Advance.

2.4 Printheads Health

2.4.1 Print Test Plot

Description

The purpose of this Service plot is to show the overall health of the printheads nozzles by visual inspection. Refer to Chapter 5 for detailed information.

Procedure

1. Go to Service Menu >2. Image Quality Plots>2.4 Printheads Health>2.4.1 Print Test Plot.

2.4.2 Advanced Test Plot

Description

The purpose of this Service plot is to help in identifying which of the printheads nozzles are failing. Refer to Chapter 5 for detailed information.

Procedure

1. Go to Service Menu >2. Image Quality Plots>2.4 Printheads Health>2.4.2 Advanced Test Plot.

2.4.3 Only for Escalations

Description

Service plot for escalations to HP Division upon request.

Procedure

1. Go to Service Menu >2. Image Quality Plots>2.4 Printheads Health>2.4.3 Only for Escalations

2.4.4 Clean ALL Printheads

Description

Launch the automatic procedures for cleaning all the printheads.

Procedure

1. Go to Service Menu >2. Image Quality Plots>2.4 Printheads Health>2.4.4 Clean ALL Printheads

2.4.5 Clean LC-C Printheads

Description

Launch the automatic procedures for cleaning the LC-C printheads.

Procedure

1. Go to Service Menu >2. Image Quality Plots>2.4 Printheads Health>2.4.5 Clean LC-C Printheads

2.4.6 Clean Y-MK Printheads

Description

Launch the automatic procedures for cleaning the Y-MK printheads.

Procedure

1. Go to Service Menu >2. Image Quality Plots>2.4 Printheads Health>2.4.5 Clean Y-MK Printheads

2.4.7 Clean LM-M Printheads

Description

Clean LM-M Printheads

Procedure

1. Go to Service Menu >2. Image Quality Plots>2.4 Printheads Health>2.4.5 Clean LM-M Printheads

2.5 Geometry Check

Description

The purpose of this Service plot is to provide a template for checking the printer's length accuracy and figure distortion. Refer to Chapter 5 for detailed information.

Procedure

1. Go to Service Menu >2. Image Quality Plots>2.5 Geometry Check.

2.6 Geometry Check

Description

The purpose of this Service plot is to help in diagnose any defect in the encoder strip. Refer to Chapter 5 for detailed information.

1. Go to Service Menu >2. Image Quality Plots>2.6 Scan Axis Check.

2.11 Others

Description: Not used

Procedure

3. Inks On Substrate Test

3.1 Print Ink Test Plot

Description

The purpose of this Service plot is for determining the level of performance of the Drying and Curing modules.

Procedure

1. Go to Service Menu >3. Ink On Substrate>3.1 Print Ink Test Plot.

4. Reset Life Counters **(NEVER DONE BY CUSTOMER)**

4.0 Reset Maintenance Kit Usage

Description

The purpose of this Service Utility is to check the maintenance kit usage and/or reset the life counter of all the components included in the maintenance kit.

Procedure

1. Go to Service Menu >4. Reset Life Counters>4.0 Reset Maintenance Kit Usage.
2. Select the Service Maintenance Kit for which you want to reset the life counters.

- 4.0.1 Reset SMK1 = Resets the life cycles of the following: Carriage Assembly, Trailing cable, Ink Tubes, Belt, Scan Motor, Heating (Dryer) IR Sensor, Curing IR Sensor, Carriage lubrication, Line sensor (hours)
- 4.0.2 Reset SMK2 = Resets the life cycles of the following: Service Station Motor, Heating IR Sensor, Carriage lubrication, Rack Motor, Curing IR Sensor, Printhead Cleaning Counters, Spit Plate spittoon (liters), Line sensor (hours)
- 4.0.3 Reset SMK3 = Resets the life cycles of the following: Aerosol filters, Heating IR Sensor, Carriage lubrication, Curing IR Sensor, Line sensor (hours)

The printer displays the usage percentage and asks you if you want to reset the life counter.

3. Press **OK** if you want to reset the life counter or **Back** if you do not want to reset the life counter. If you choose not to reset the life counter, the printer exits the utility.

4.3 Reset Substrate Path Menu

Description

The purpose of this Service Utility is to check the service part usage and/or reset the life counter for the Substrate Path:

- 4.3.1 Rewinder Motor > Resets the Rewinder Motor (hours)
- 4.3.2 Drive Roller Motor > Reset the substrate motor
- 4.3.3 OMAS Sensor > Resets OMAS (M of media length, navigable success, navigable failures).
- 4.3.4 Vacuum Fan > Resets Vacuum Fans (hours).

4.4 Reset ISS Menu

Description

The purpose of this Service Utility is to check the service part usage and/or reset the life counter for the ISS:

- 4.4.1 APS Pumps > Resets the APS Pump in cycles and hours.

4.5 Reset Scan Axis Menu

Description

The purpose of this Service Utility is to check the service part usage and/or reset the life counter for the Scan Axis:

- 4.5.1 Reset Belt Cycles: Resets the Belt cycles
- 4.5.2 Tubes/Trailing Cables: Resets the cycles of the Trailing Cable and Ink Tubes
- 4.5.3 SAX Motor Cycles: Reset the Scan Motor

4.6 Reset Carriage Menu

Description

The purpose of this Service Utility is to check the service part usage and/or reset the life counter for the Carriage:

- 4.6.1 Carriage Cycles: Reset the cycles of the Carriage
- 4.6.2 New Line Sensor: Reset the Line Sensor (hours)
- 4.6.3 Cutter Cycles: Reset the cutter cycles (number of times substrate has been cut)
- 4.6.4 Color Sensor: Reset the SOL (hours)
- 4.6.5 Carriage Lubrication: Resets the Carriage lubricant

4.7 Reset Service Station Menu

Description

The purpose of this Service Utility is to check the service part usage and/or reset the life counter for the Service Station:

- 4.7.1 Aerosol fan and filters: Resets the Aerosol fan (hours) and Aerosol Filter (liters)
- 4.7.2 SS Rack Cycles: Resets rack motor
- 4.7.3 Spit plate Replacement
- 4.7.4 Drop Detector: Resets Drop Detector (hours)
- 4.7.5 Complete Service Station: Resets the Service Station motor (cycles), Aerosol Fan (hours), Rack Motor (Cycles), Split plate spittoon (liters), Aerosol Filters (liters), Spit plate DD (liters), Drop Detector (hours)
- 4.7.6 Maintenance Cartridge
- 4.7.7 Primer Cycles: Resets the Primer

4.8 Reset Heating & Curing

Description

The purpose of this Service Utility is to check the service part usage and/or reset the life counter for the Heating and Curing:

- 4.8.1 Curing Lamps: Resets the Curing Resistors (hours)
- 4.8.2 Reset Curing Sensor: Resets Curing IR Sensor
- 4.8.3 Heating Lamps: Resets the Heating Resistors (hours)
- 4.8.4 Reset Heating Sensor: Resets the Heating IR Sensor
- 4.8.5 IR Sensors Cleaning: Resets the Curing IR Sensor and Heating IR Sensor

5. Service Calibrations

Service calibrations allow you to calibrate printer components and settings to ensure optimal performance. This section guides you through the calibration procedures and provides information about each calibration.

5.3 Substrate Path Menu

5.3.1 Paper Advance Calibration

Description

The purpose of this Service Calibration is to calibrate the nominal advance of the media. This calibration is necessary to control the exact movement of the media in order to avoid print quality problems like banding. Perform the Service Accuracy Calibration whenever:



NOTE: In order to perform this Calibration, you should order the Paper Advance Calibration Kit (Part Number Q1273-60296) which contains two cut sheets of HP Universal Instant-dry Gloss Photo media (36-inches wide by 42-inches long) ⇒

- Banding is detected in prints.
- Drive Roller is disassembled or replaced.
- Paper-axis Assembly is disassembled or replaced.

The Paper Advance Calibration is split into three parts and should **always** be done in this order:

- Print Calibration Pattern - The Printer first calibrates the Analog Encoder and then prints the Paper Advance Calibration pattern.
- Scan Calibration Pattern - The Printer scans the Paper Advance Calibration pattern in order to calibrate the nominal advance of the media.



NOTE: Only scan the Calibration Pattern in the Printer that was used to actually print it. Using the Calibration in a different Printer could cause it to experience media advance problems. After scanning the Calibration Pattern, it should be discarded.

- Clean Drive Roller - After loading media that the customer will use, the Printer “prepares” the media path to prevent any future advance problems.



NOTE: Make sure that you unload media from the Printer before performing the Paper Advance Calibration.

NOTE: Disabling the Heaters ‘1.8.2’ will significantly speed up this procedure.

Procedure

1. Go to Service Menu >5. Service Calibration Menu>5.3 Substrate Path Menu.
2. Select ‘Print Calibration Pattern’.

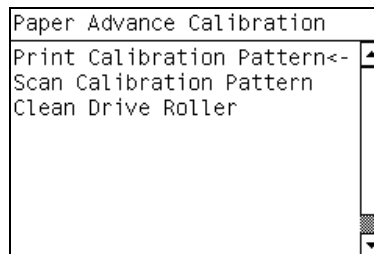

3. When the following message displays on the front panel, you must select whether you would like to continue with the calibration by pressing the **OK** key. Press **Back** or **Cancel** to exit the calibration.

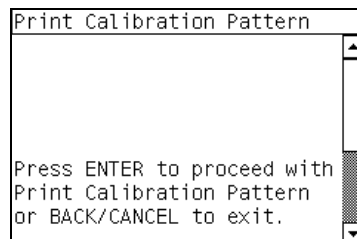

4. The Printer will start to calibrate the Analog Encoder and the following message will be displayed on the Front Panel.

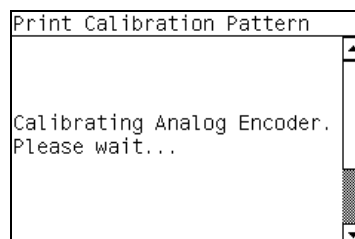

If the Calibration is not done or if the values are out of the limits, a warning message will display on the Front Panel. In this case, try the following:

- Check that the Printer has the latest Firmware version. If not, update the Firmware to the latest version.
- Retry the Paper Advance Calibration.

- If the problem continues, replace the Encoder Strip and Encoder Sensor ⇒ page 399.

5. Once the Analog Encoder has been calibrated correctly, the following message will display on the Front Panel. Press the **OK** key in order to start the media load process.

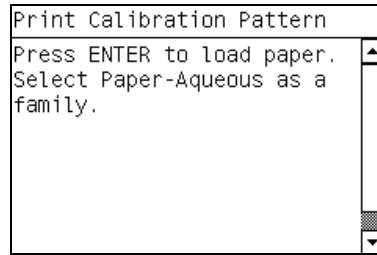

6. Load a sheet of HP Universal Instant-dry Gloss Photo media (product number Q6575A) that was included in the Paper Advance Calibration Kit (Part Number Q1273-60296) following the instructions on the Front Panel. If the kit is not available, then cut a piece of HP Universal Instant-dry Gloss Photo media that is 36-inches wide and at least 42-inches long. Select Aqueous type of media during the loading process.
7. Once the media is loaded into the Printer, the following message will display on the Front Panel. If roll media has been used instead of cut sheet media, then you will need to unroll a minimum of 1 meter of media in order to prevent any back tension which could cause any media advance problems. Press the **OK** key to continue.

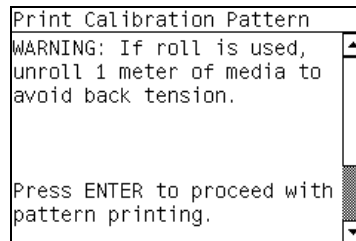

8. The Printer will start to print the Paper Advance Calibration Pattern. This could take several minutes during which the following message will be displayed on the Front Panel.

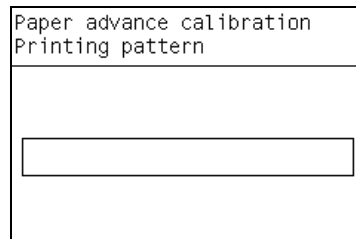

9. Once the Accuracy Calibration Pattern has been printed successfully, the following message will be displayed on the Front panel. Press the **OK** key to continue.

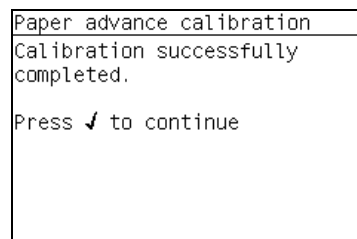

If the Paper Advance Calibration fails for any reason, a warning message will display on the Front Panel. In this case, try the following:

- Retry the Paper Advance Calibration.

- If necessary, perform a Printhead Recovery through the Front Panel and retry the Calibration.



NOTE: Remove the pattern from the printer and leave it to dry for a few minutes before continuing with the Calibration.

NOTE: MAKE SURE NO MEDIA IS LOADED INTO THE PRINTER BEFORE STARTING TO SCAN THE CALIBRATION PATTERN.

10. You will need to re-enter the Paper Advance Calibration submenu and scroll to “Scan Calibration Pattern” and press **OK**.

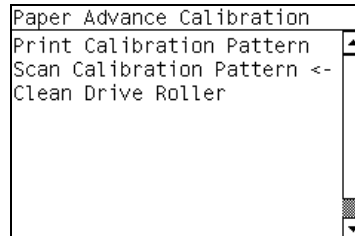

11. When the following message displays on the front panel, you must select whether you would like to continue with the calibration by pressing the **OK** key. Press **Back** or **Cancel** to exit the calibration.

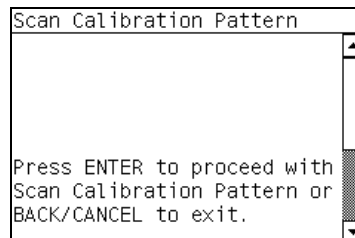

12. A message will display advising you that you will need to load the Calibration Pattern in to the Printer. Make sure that you rotate the printed pattern 90° clockwise and reload it printed-side down, so that the black arrows go into the printer first. Press the **OK** key to continue.

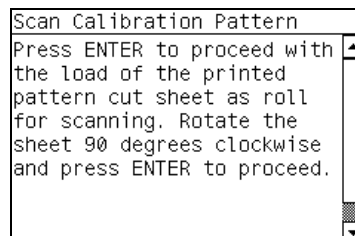

NOTE: Take note that the Calibration Pattern will be loaded as a Roll and NOT as a Sheet.

13. As you are loading a single sheet, the following message will be displayed. Select to skip the check.

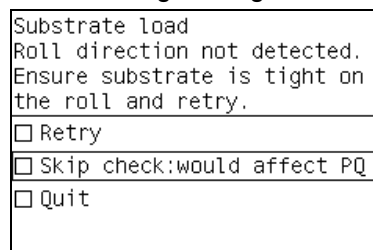

- The following message is displayed, select OK and follow the on screen instructions to finish the loading procedure.

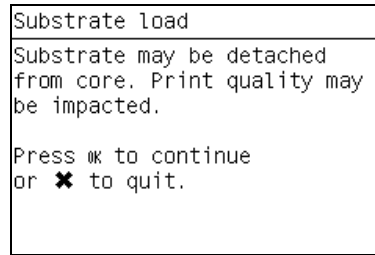

NOTE: Only scan the Calibration Pattern in the Printer that was used to actually print it. Using the Calibration in a different Printer could cause it to experience media advance problems. After scanning the Calibration Pattern, it should be discarded.

NOTE: When Loading the Calibration Pattern, use the Cutter blade on the Print Platen to align the edge of the sheet. If you follow this advise, you will prevent the cutter from cutting a section of the Calibration Pattern, which could cause the Calibration to fail.

- Load the Calibration Pattern following the instructions on the Front Panel. Once the Calibration Pattern is loaded correctly, the following message will be displayed on the Front Panel. Press the **OK** key to continue.

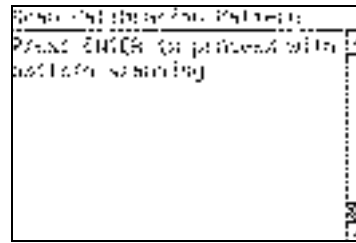

- The Printer will scan the Calibration Pattern which could take several minutes.
- The following screen is displayed.

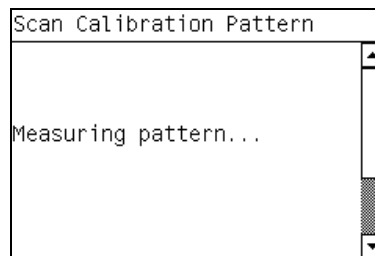

- The following screen is displayed.



19. The following screen is displayed.

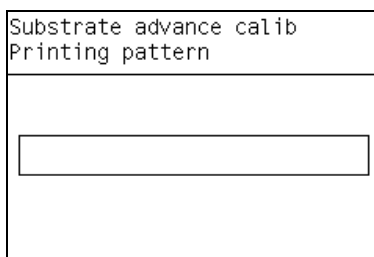

20. The following screen is displayed.

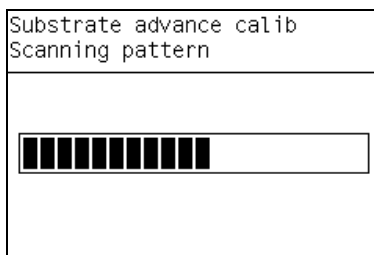

21. The following screen is displayed.

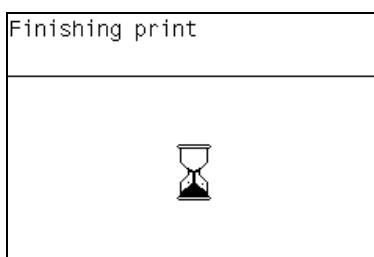

22. The following screen is displayed.



23. Once the calibration is completed successfully, the following message will be displayed on the Front Panel. Press the **OK** key to continue.

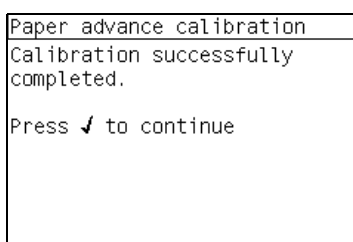

If the Paper Advance Calibration fails for any reason, a warning message will display on the Front Panel. In this case, try the following:

- Check that the Calibration Pattern was not incorrectly cut (trimming the actual pattern) during the media load process. If this is the case, perform the Paper Advance Calibration again from **step 1**.
- Perform a Line Sensor Calibration (⇒ page 162) and then re-scan the Calibration pattern.
- Replace the Line Sensor ⇒ page 486.

- If the problem continues, replace the Media-Axis Motor ⇒ page 422.



NOTE: After the Paper Advance Calibration has been performed correctly, you **MUST** perform the Clean Drive Roller procedure. If this is **NOT** done, the Printer will not perform correctly and could cause Print Quality problems.

NOTE: Before starting the Clean Drive Roller procedure, make sure you first load media into the Printer that the customer will normally use to print.

24. You will need to re-enter the Paper Advance Calibration submenu and scroll to “Clean Drive Roller” and press **OK**.

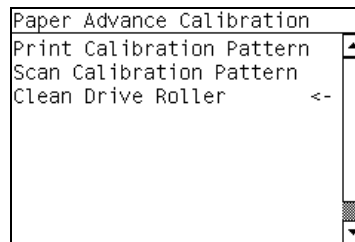

25. When the following message displays on the front panel, you must select whether you would like to continue with the cleaning of the Drive Roller by pressing the **OK** key. Press **Back** or **Cancel** to exit the calibration.

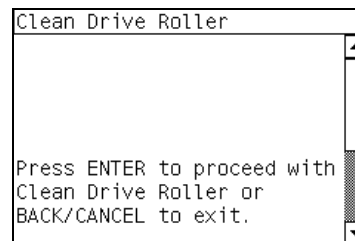

The Printer will begin the Drive Roller Cleaning procedure. This could take several minutes during which the following message will be displayed on the Front Panel.

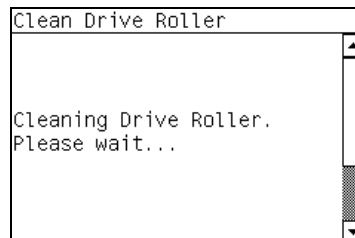

26. Reboot the printer after performing the tests.

5.3.2 OMAS calibration

Description

The purpose of this Service Calibration is to calibrate the OMAS Module. The calibration process consists of printing a special calibration plot and then scanning it with the printer. The scanned result values are compared with the actual printed values to obtain a PASS/FAIL result.

Perform the OMAS Module Calibration as follows:



NOTE: In order to perform this Calibration, you should order the Paper Advance Calibration Kit (Part Number Q1273-60296) which contains two cut sheets of HP Universal Instant-dry Gloss Photo media (36-inches wide by 42-inches long).

NOTE: Disabling the Heaters '1.8.2' will significantly speed up this procedure.

Procedure

1. Go to Service Menu >5. Service Calibration Menu>5.3 Substrate Path Menu>5.3.2 OMAS Calibration.
2. When the following message displays on the front panel, select the **OK** key.

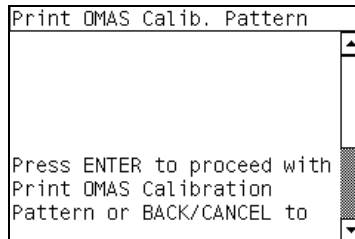

3. If media is already loaded, the following message displays on the front panel and the media is unloaded.

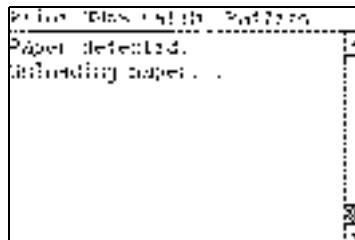

4. If the media cannot be unloaded automatically, the Front Panel will show the following message.

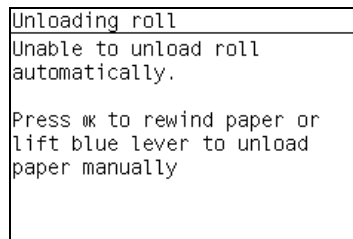

5. Follow the instructions and unload the media.
6. The Front Panel prompts you to load media.



NOTE: During this calibration process you have to load the media with the Carriage positioned in the print path.

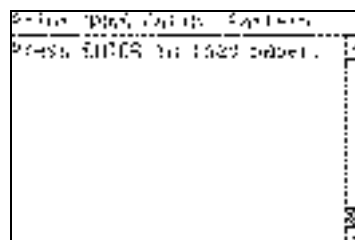

- Raise the Media Lever.
- Load the media.
- Lower the medial lever.

7. Select the media (HP Paper Aqueous).

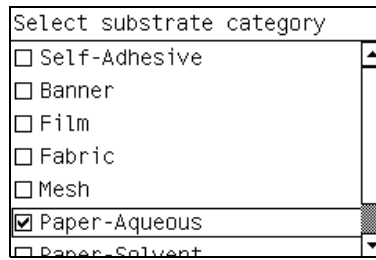

8. The media calibration process starts and front panel shows the following messages:

- Calibrating paper advance.
- Trimming roll edge. Please wait.

9. The Front Panel then prompt you to unroll 1 meter of media to avoid back tension. Unroll 1 meter of media and press **OK**.

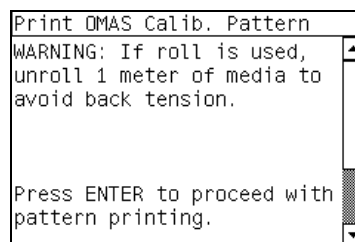

10. The Printer will start to print the OMAS Calibration Pattern. This could take several minutes during which the following message will be displayed on the Front Panel.

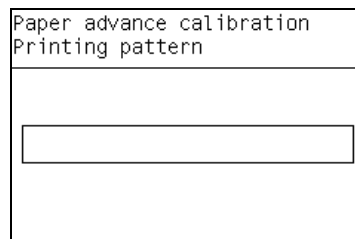

11. Once the OMAS Calibration Pattern has been printed successfully, the following message will be displayed on the Front panel. Press the **OK** key to continue.

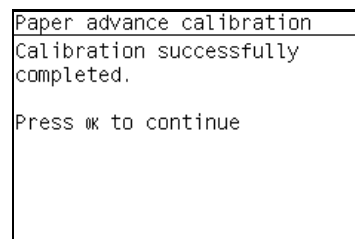

If the OMAS Calibration fails for any reason, a warning message will display on the Front Panel. In this case, try the following:

- Retry the Paper Advance Calibration.



NOTE: Remove the pattern from the printer and leave it to dry for a few minutes before continuing with the Calibration.

NOTE: MAKE SURE MEDIA IS NOT LOADED INTO THE PRINTER BEFORE STARTING TO SCAN THE OMAS CALIBRATION PATTERN.

Scan OMAS Calibration Pattern

1. You will need to re-enter the OMAS Calibration submenu and scroll to "Scan Calibration Pattern" and press **OK**.

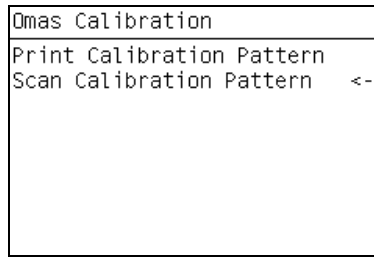

2. When the following message displays on the front panel, you must select whether you would like to continue with the calibration by pressing the **OK** key. Press **Back** or **Cancel** to exit the calibration.

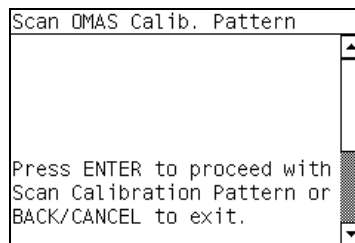

3. A message will display advising you that you will need to load the OMAS Calibration Pattern in to the Printer. Make sure that you rotate the printed pattern 90° clockwise and reload it printed-side down. Press the **OK** key to continue.

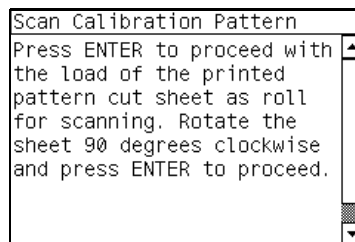

4. Load the OMAS Calibration Pattern following the instructions on the Front Panel.

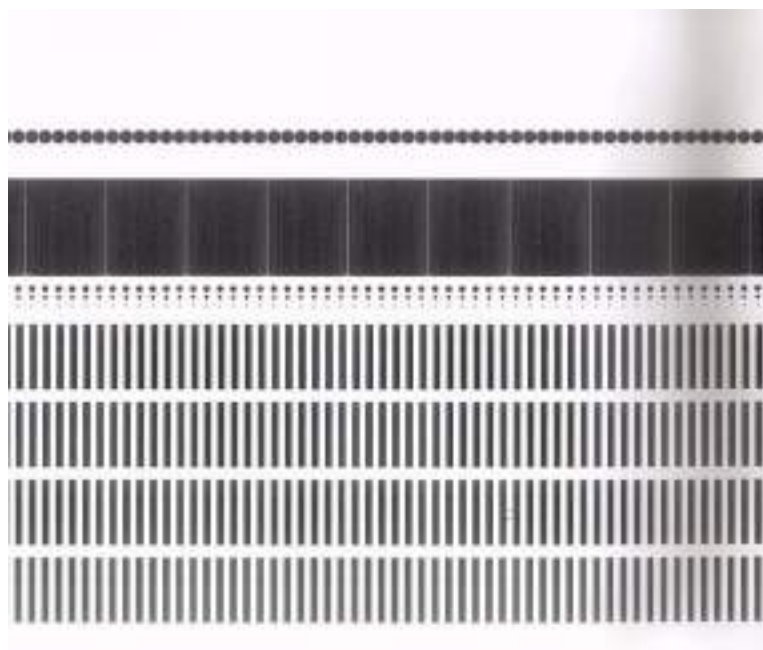
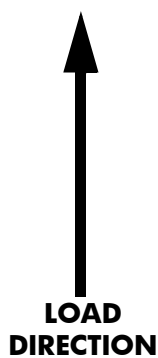

- Once the OMAS Calibration Pattern is loaded correctly, the following message will be displayed on the Front Panel. Press the **OK** key to continue.

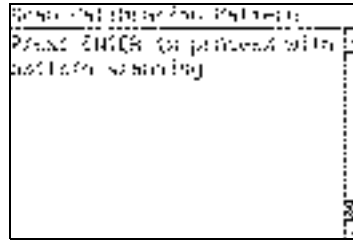

- The Printer will scan the OMAS Calibration Pattern which could take several minutes. Once the calibration is completed successfully, the following message will be displayed on the Front Panel. Press the **OK** key to continue.

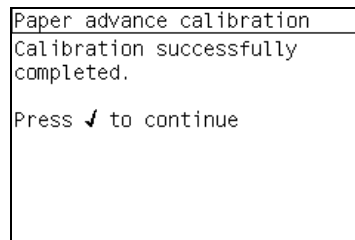

If the OMAS Calibration fails for any reason, a warning message will display on the Front Panel. In this case, try the following:

- Check that the OMAS Calibration Pattern was not incorrectly cut (trimming the actual pattern) during the media load process. If this is the case, perform the OMAS Calibration again from **step 1**.
- Replace the OMAS Sensor ⇒ page 424.
- Replace the OMAS Controller Card ⇒ page 437.
- If the problem continues, replace the Media-Axis Motor ⇒ page 422.

5.3.3 OMAS Temperature Calibration

Description

The purpose of this test is to calibrate the internal OMAS temperature sensor (this sensor is inside the OMAS sensor PCA, it is not the TOMAS sensor. This test compares the TOMAS sensor with the internal OMAS sensor and uses this information to calibrate the internal OMAS sensor.

This procedure must be performed whenever the OMAS sensor or the OMAS Controller PCA is replaced.

Procedure

- Go to Service Menu >5. Service Calibration Menu>5.3 Substrate Path Menu>5.3.3 OMAS Temperature Calibration
- The front panel displays the following message, press Ok to continue.

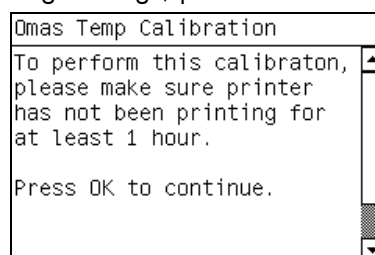

The front panel displays the following message.

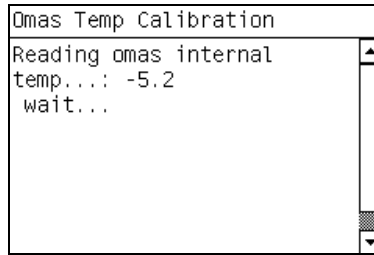

3. The front panel displays the results of the test, press Ok to continue.

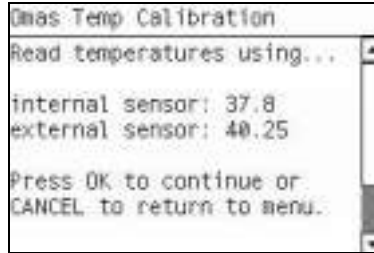

5.3.4 Vacuum Calibration

Description

The purpose of this test is to set the default nominal and real values of the Vacuum Fan Assembly.



NOTE: This Service Calibration should ONLY be performed when the Vacuum Fan Assembly has been replaced.

Procedure

1. Go to Service Menu >5. Service Calibration Menu>5.3 Substrate Path Menu>5.3.4 Vacuum Calib.
2. When the following message displays on the front panel, select the **OK** key.

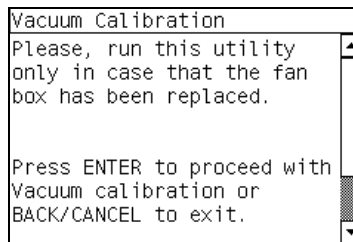

3. The Printer will set the default nominal and real values of the Vacuum Fan.

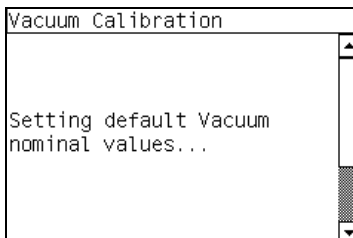

4. Once the calibration is completed, OK will be displayed on the Front Panel.

5.3.5 Rewinder CO Voltage Calibration

Description

This test must be performed whenever the Rewinder Assembly has been replaced or one of the rewinder gears have been replaced. The test calculates the optimum power required to move the rewinder system.

Procedure

1. Go to Service Menu >5. Service Calibration Menu>5.3 Substrate Path Menu>5.3.5 Rewinder CO Voltage Calib.
2. The front panel displays the following screen, press ok to continue.

```
Rewinder Voltage Calibration
Please take out the media
from the spindle and insert
the spindle

Do you want to start the
calibration?

Press ENTER to accept or
```

The front panel displays the following screen.

```
Rewinder Voltage Calibration
Doign calibration...
```

When the procedure is finished the following screen is displayed.

```
Rewinder Voltage Calibration

  00  K  K
  0 0  K  K
  0 0  KK
  0 0  KK
  0 0  K  K
  00  K  K
```

5.5 Scan Axis Menu

5.5.1 Scan Axis Calibration

Description

The purpose of this Service Calibration is to carry out a PWM check, calibrate the intensity of the Line Sensor and calibrate the Line Sensor position to the Black Printhead.

Perform the Scan Axis Calibration whenever:

- Carriage is disassembled or replaced.
- Encoder Strip is disassembled or replaced.
- Center Platen is disassembled or replaced.



NOTE: Disabling the Heaters '1.8.2' will significantly speed up this procedure.

Procedure

1. Go to Service Menu >5. Service Calibration Menu>5.5 Scan Axis Menu>5.5.1 Scan Axis Calibration.
2. When the following message displays on the front panel, select the **OK** key.

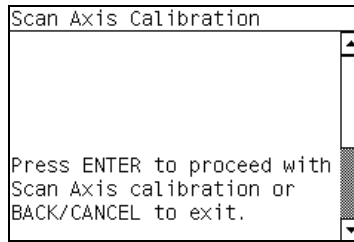

3. If media is not loaded, the following message displays on the front panel. Load media in to the Printer and start again from **step 1**.

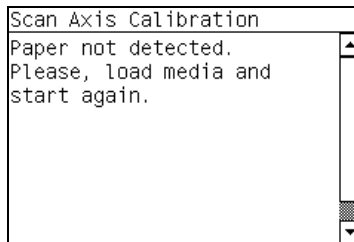

Before continuing, the Printer will check the following:

- The Media Lever is in the lowered position.
- The correct paper type is loaded (check list on previous page).
- The correct paper size (minimum paper size 24 inches).

If these conditions are **not** met, a warning will be displayed on the Front Panel and you will need to restart the Calibration from **step 1**.



NOTE: In order to perform this Calibration, you should order the Paper Advance Calibration Kit (Part Number Q1273-60296) which contains two sheets of HP Productivity Gloss Media.



WARNING! Make sure you keep your hands away from the Print Platen as the Carriage will be moving at high speed and you could injure yourself or damage the Carriage Assembly.

4. The Printer will start to check the PWM. Once the PWM has been checked, the results will be displayed on the Front Panel. Press **OK** to continue or press **Back** or **Cancel** to exit the calibration.

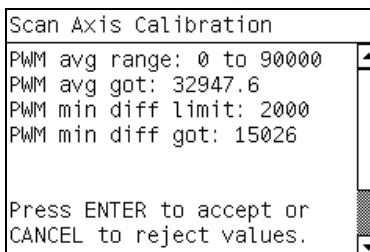

- The Printer will start to calibrate the Line Sensor. Once the Line Sensor has been calibrated, the results will be displayed on the Front Panel. Press **OK** to continue or press **Back** or **Cancel** to exit the calibration.

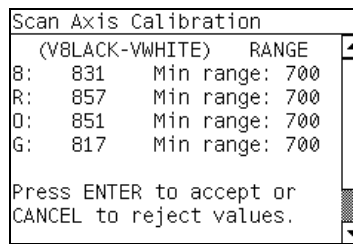

If the values are not within the range specified, an error will display on the Front Panel. In this case, try the following:

- Try the Scan-Axis Calibration again.
 - Replace the Line Sensor ⇒ page 486.
- The Printer will start to calibrate the Line Sensor position to the Black Printhead. It will print a line of black dots and then scan them:



- Once the Line Sensor has been calibrated, the results will be displayed on the Front Panel. Press **OK** to finish the calibration or press **Back** or **Cancel** to exit the calibration.

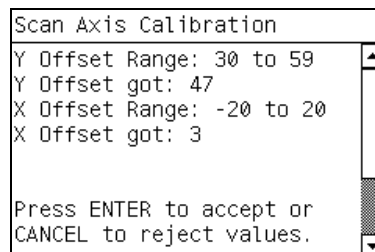

- The Printer will now perform the Printhead Alignment.

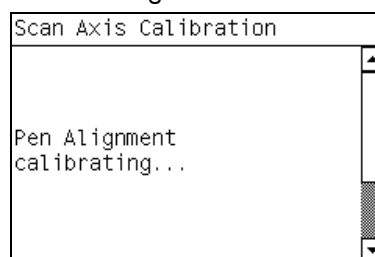

9. When the following message displays on the front panel, you must select whether you would like to continue with the calibration by pressing the **OK** key. Press **Back** or **Cancel** to exit the calibration.

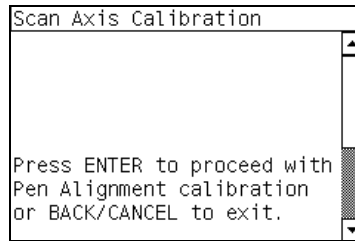

10. Once the Printhead Alignment is completed, the following message will be displayed on the Front Panel. Press the **OK** key to continue.

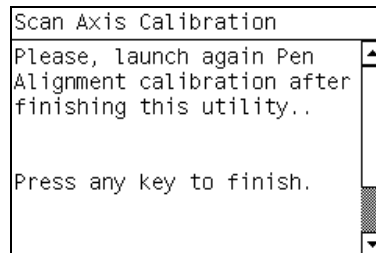

If the Printhead Alignment fails for any reason, a warning message will display on the Front Panel. In this case, try the following:

- Go to the Front Panel menu and retry the Printhead Alignment. If the Alignment completes successfully, perform the Color Calibration ⇒.
 - If the Alignment fails again, check the Alignment pattern to see if any of the Printheads are printing incorrectly. If necessary, perform a Printhead Recovery through the Front Panel and retry the Printhead Alignment.
11. Once the complete Scan Axis calibration is completed successfully, OK will be displayed on the Front Panel.

5.5.2 Drop detector calibration

Description

The purpose of this Service Calibration is to calibrate the Drop Detector in relation to the Carriage Assembly.

Perform the Drop Detector Calibration whenever:

- Drop Detector is removed or replaced.

Procedure

1. Go to Service Menu >5. Service Calibration Menu>5.5 Scan Axis Menu>5.5.2 Drop Detector Calibration.
2. When the following message displays on the front panel, you must select whether you would like to continue with the calibration by pressing the **OK** key. Press **Back** or **Cancel** to exit the calibration.

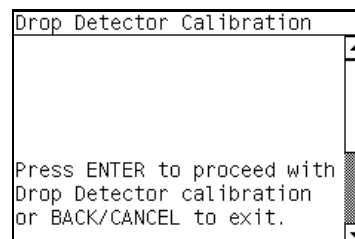

3. The Printer will start to calibrate the Drop Detector. Once the Drop Detector has been calibrated, the results will be displayed on the Front Panel. Press any key on the Front Panel to finish the calibration.

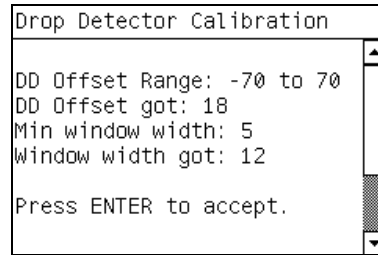

4. Once the calibration is completed, OK will be displayed on the Front Panel.

5.6 Carriage Menu

5.6.1 Line Sensor Calibration

Description

The purpose of this service calibration is to calibrate the intensity of the line sensor in the Carriage PCA. An incorrect calibration can result in edge-detection failures during media loading and incorrect reading of prints that are used for alignment or calibration.

Perform the Line Sensor Calibration whenever:

- Edge detect procedure fails during media loading.
- Carriage is disassembled or replaced.
- Line Sensor is disassembled or replaced.
- Banding is detected in prints.
- Misalignment between colors is detected.



NOTE: Make sure you load one of the following media into the Printer before performing this calibration. If none of them are available use the service part Q1273-60296:

- HP Bond Paper.
- HP Glossy Media.
- HP Coated Paper.
- HP Productivity Photo Gloss.
- HP Heavyweight Coated Paper.
- HP Super Heavyweight Coated Paper.
- HP Bright White Inkjet Paper.

NOTE: Disabling the Heaters '1.8.2' will significantly speed up this procedure

Procedure

1. Go to Service Menu >5. Service Calibration Menu>5.6 Carriage Menu>5.6.1 Line Sensor Calibration.

- When the following message displays on the front panel, you must select whether you would like to continue with the calibration by pressing the **OK** key. Press **Back** or **Cancel** to exit the calibration.

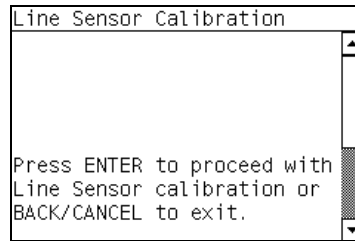

- If media is not loaded, the following message displays on the front panel. Load media in to the Printer and start again from **step 1**.

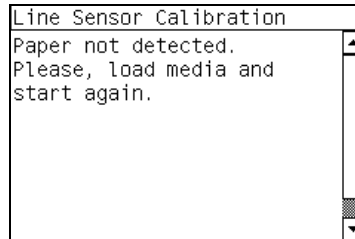

Before continuing, the Printer will check the following:

- The Media Lever is in the lowered position.
- The correct paper type is loaded (check list on previous page).
- The correct paper size (minimum paper size 24 inches).

If these conditions are **not** met, a warning will be displayed on the Front Panel and you will need to restart the Calibration from **step 1**.



NOTE: Make sure you keep your hands away from the Print Platen as the Carriage will be moving at high speed and you could injure yourself or damage the Carriage Assembly.

- The Printer will start to calibrate the Line Sensor. Once the Line Sensor has been calibrated, the results will be displayed on the Front Panel. Press **OK** to continue or press **Back** or **Cancel** to exit the calibration.

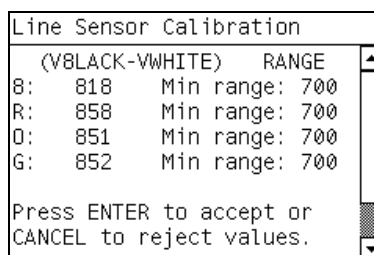

If the values are not within the range specified, an error will display on the Front Panel. In this case, try the following:

- Try the Scan-Axis Calibration again.
- Replace the Line Sensor ⇒ page 486.

- The Printer will start to calibrate the Line Sensor position to the Black Printhead. It will print a line of black dots and then scan them:



- Once the Line Sensor has been calibrated, the results will be displayed on the Front Panel. Press **OK** to finish the calibration or press **Back** or **Cancel** to exit the calibration.

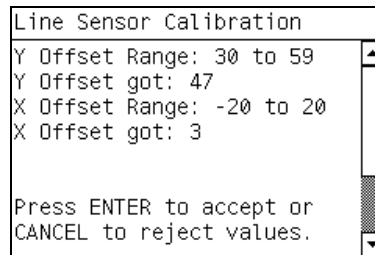

- The Printer will now perform the Printhead Alignment. When the following message displays on the front panel, select the **OK** key.

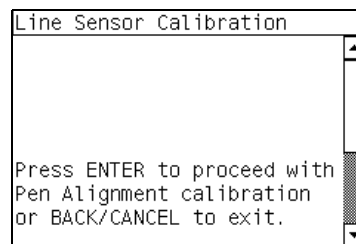

- Once the Printhead Alignment is completed, the following message will be displayed on the Front Panel. Press the **OK** key to continue.

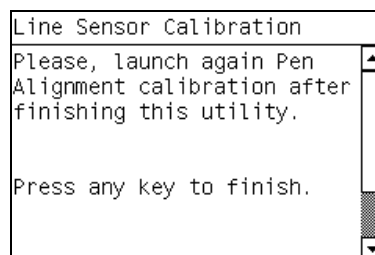

- If the Printhead Alignment fails for any reason, a warning message will display on the Front Panel. In this case, try the following:
 - Enter the Front Panel menu and retry the Printhead Alignment. If the Alignment completes successfully, then perform the Color Calibration.
 - If the Alignment fails again, check the Alignment pattern to see if any of the Printheads are printing incorrectly. If necessary, perform a Printhead Recovery through the Front Panel and retry the Printhead Alignment.
- Once the complete Line Sensor calibration is completed successfully, OK will be displayed on the Front Panel.

5.6.2 Primer Calibration

Description

The purpose of this Service Calibration is to find the optimum position of the Primer Assembly with respect to the Carriage.

The calibration is a visual procedure so you will have to remove the Right Hand cover before starting.

Procedure

1. Go to Service Menu >5. Service Calibration Menu>5.6 Carriage Menu>5.6.2 Primer Calibration.
2. Remove the Right Cover => page 319).
3. Block the Printhead Cleaning Cartridge door switch in the closed position.
4. When the following message displays on the front panel, press any key to continue.

```
PrimerCalibration
Primer Calibration is going
to start.
Computing the real ScanAxis
Nominal offset.
Press any key to continue.
```

5. The front panel displays the following message.

```
PrimerCalibration
Please Remove the Service
Station Cover Carefully
Hold Service Station Door
Sensor pressed to avoid
messages
Beware of moving parts
Press any key to continue
```

6. The calibration process starts and front panel shows the following messages:
 - Homing Primer.
 - Uncapping SVS.
 - Homing Carriage.
 - Computing the Left Scan-Axis Offset.
7. Once the Left Scan-Axis Offset has been calculated the Front Panel prompts you use the **Up/Down** keys to move the carriage until the **RIGHT** edge of the Left Alignment Mark on the Carriage Cover is perfectly aligned with the Primer positioning indicator.

```
PrimerCalibration
Use the up/down buttons to
move the carriage until the
long piece of plastic falls
from the metal piece of the
latch
Press Ok when done.
```

8. Use the **Up** (move left) and **Down** (move right) keys to move the Carriage until the RIGHT edge of the Left Alignment Mark is correctly aligned with the Primer Positioning Indicator and press **ENTER**.

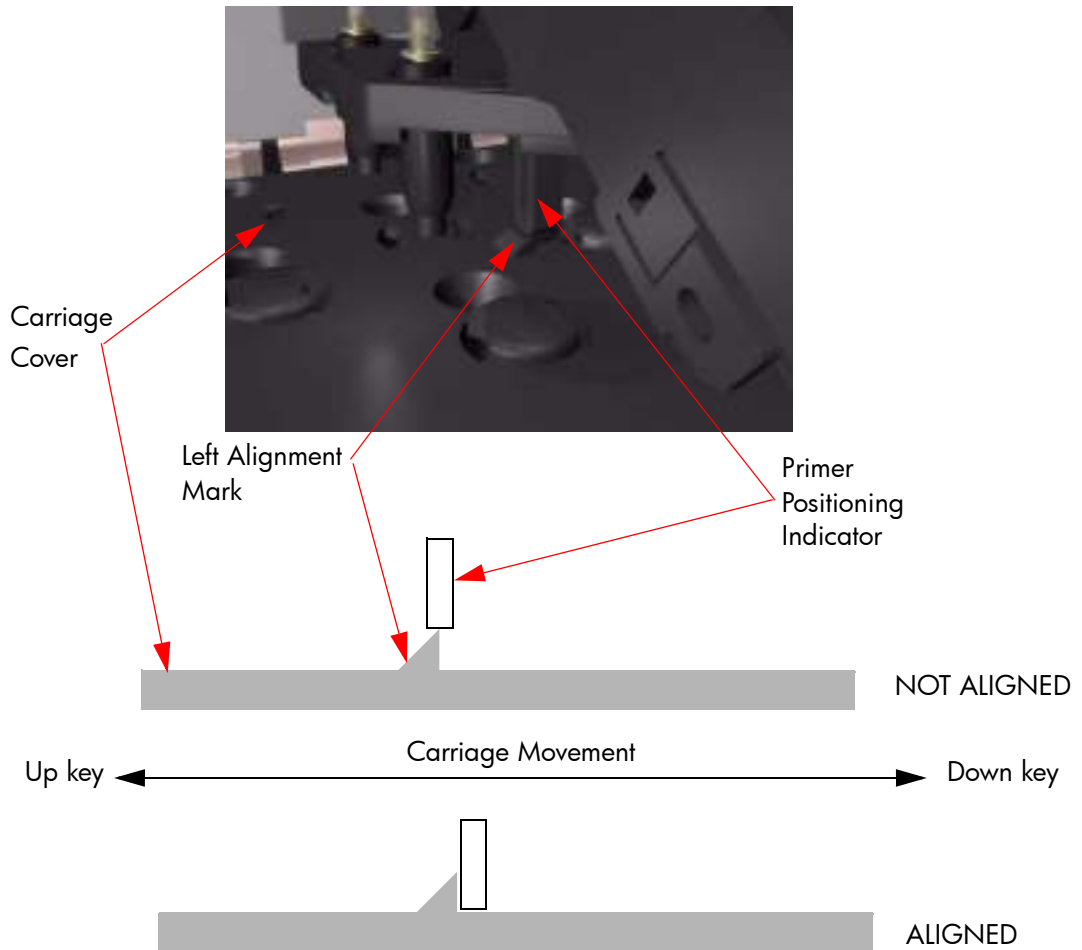

NOTE: To more easily detect the exact position while aligning the Carriage to the Primer it is a good idea to lightly press down on the Primer while you are moving the Carriage.

While the Carriage is moving the Front Panel shows the actual position and the direction of movement and prompts you to press **ENTER** when done.

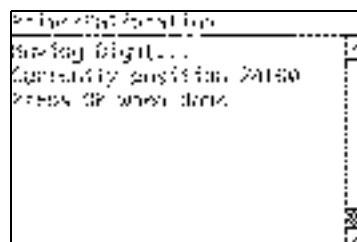

9. The Front Panel shows the actual left offset value and the system calculates the Fight Scan-Axis Offset.

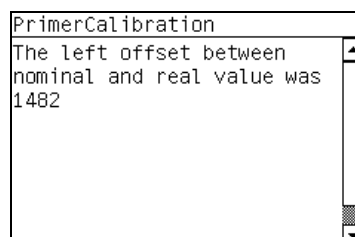

10. Once the Right Scan-Axis Offset has been calculated the Front Panel prompts you use the **Up**/**Down** keys to move the carriage until the LEFT edge of the Right Alignment Mark is correctly aligned with the Primer Positioning Indicator and press **ENTER**.

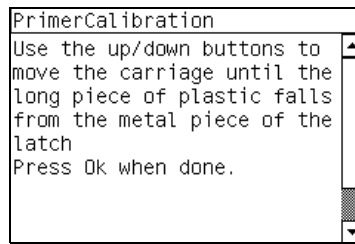

11. Use the **Up** and **Down** keys to move the Carriage until the LEFT edge of the Right Alignment Mark is correctly aligned with the Primer Positioning Indicator and press **ENTER**.

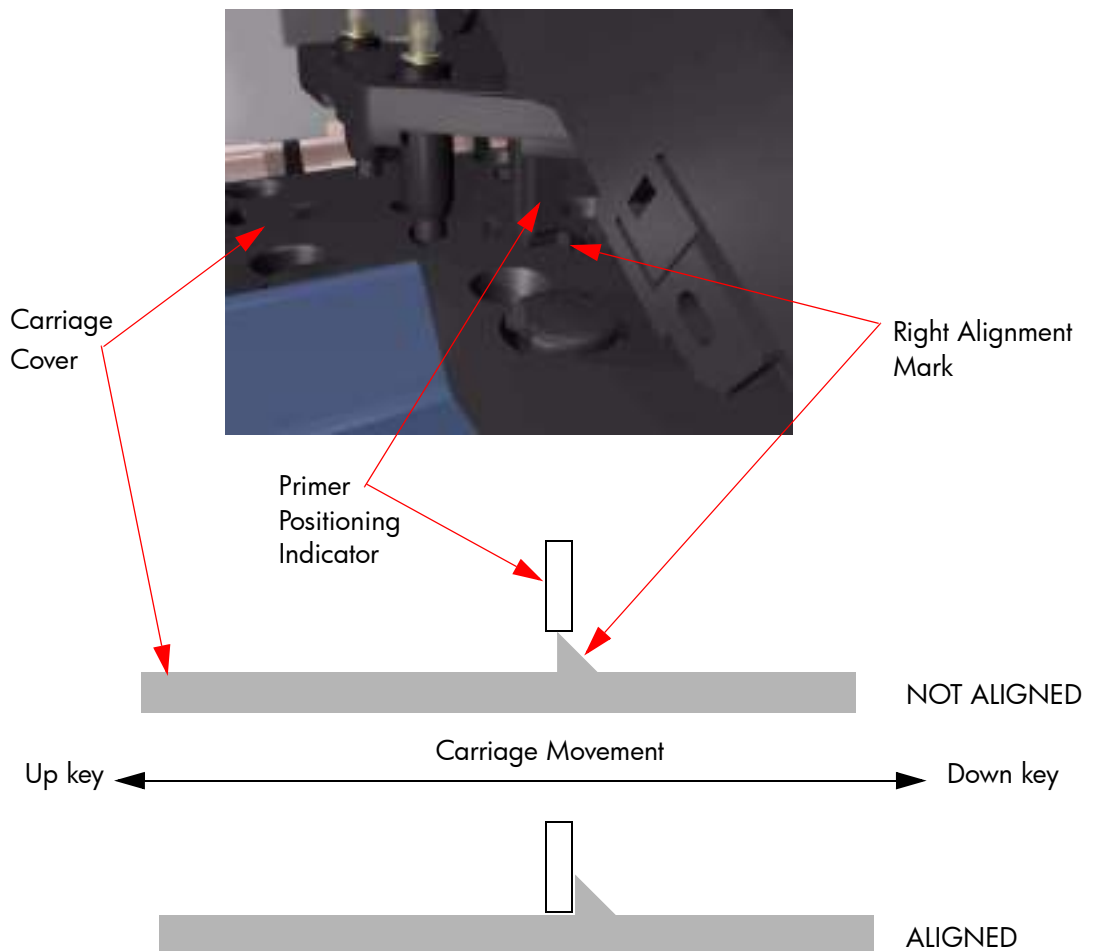

NOTE: To more easily detect the exact position while aligning the Carriage to the Primer it is a good idea to lightly press down on the Primer while you are moving the Carriage.

While the Carriage is moving the Front Panel shows the actual position and the direction of movement and prompts you to press **ENTER** when done.

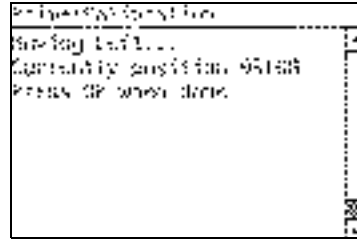

12. The Front Panel shows the actual right offset value.

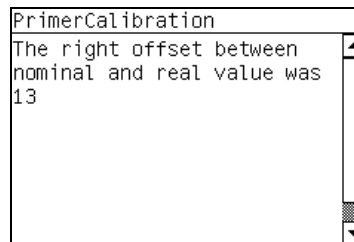

13. The calibration process continues and front panel shows the following messages as the new nominal offset value is read and saved to NVM:
- Reading Nominal Offset.
 - New Nominal Offset is [ActualValue].
 - Saving to nvm.
 - Saved.
14. Once the calibration is completed, OK will be displayed on the Front Panel.
15. Replace the Right Hand Cover (page 319).

5.6.3 Open/Close SOL

Description

The purpose of this Service Utility is to open and close the Color Sensor shutter to verify correct operation.

Procedure

1. Go to Service Menu >5. Service Calibration Menu>5.6 Carriage Menu>5.6.3 Open/Close SOL.
2. When the following message displays on the Front Panel, select **OK**.

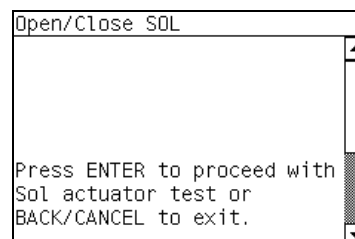

3. The Printer will perform the Open/Close SOL test and the Front Panel will display the following messages:
 - Performing SOL Full Calibration.
 - Checking ColorSensor Status.
 - Reading Lab values with SOL Shutter Closed.

- Opening SOL Shutter
- Reading Lab values with SOL Shutter Open
- Analyzing SOL Shutter Open status.

If there is a failure at this point, the Front Panel will display system error code **58:10** ⇒ page 109.

4. If the utility exits correctly, OK will be displayed on the Front Panel.

5 Print Quality

• Initial Print Quality Troubleshooting Actions	228
• How to Use the Image Quality Plots	228
• 2.2.1 Printhead Alignment Test Plot	229
• 2.4.1 Printheads Health Test Plot.....	231
• 2.3.2 Substrate Advance Test Plot	233
• 2.4.2 Advanced Printhead Health Test Plot	235
• 2.4.3 Plot for escalation only	239
• 2.5 Geometry Check	239
• 3.1 Inks on Substrate Test.....	240
• 2.6 Scan Axis check.....	241
• Force Drop Detection	242
• Substrate advance issues.....	243

Initial Print Quality Troubleshooting Actions

For the vast majority of print quality problems, a Call Agent should request that the customer performs the troubleshooting actions in the *Maintenance and Troubleshooting Guide* in the section 'Troubleshooting print-quality issues'. Most problems can be resolved using these procedures without the need for an on-site visit.

How to Use the Image Quality Plots

The Printer contains a series of basic image quality tests which help you to diagnose image quality defects. There is an option to print all three diagnostic prints at once or print them individually.

The three Image Quality plots test the printer in different ways, but can be split into the following sections:

- **Printhead Alignment:** The purpose of this test is to test the accuracy of the current printhead alignment.
- **Printheads Health:** This test is designed to check if the printhead nozzles print correctly.
- **Substrate Advance:** This test enables you to visually check if there are any substrate advance issues with the printer.

To print all the test diagnostic prints shown here go to the Service Menu List>2. Image Quality Plots> 2.1 Print ALL plots.

Considerations for Printing the Diagnostic Print

1. Use the same type of paper that the customer was using when they experienced the image quality problem.
2. If you do not see any problems with the Image Quality Test, then the problem may not be with the printer itself. The problem may be with the RIP.

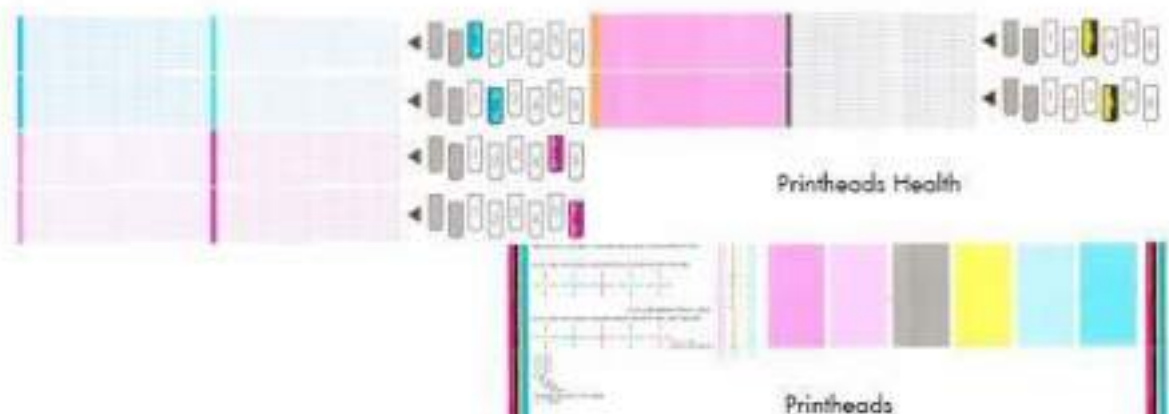

2.2.1 Printhead Alignment Test Plot

To print this test plot go to Menu List>2. Image Quality Plots>2.2 PH Alignment Menu>2.2.1 Test Plot.

This test is designed to check the accuracy of the current printhead alignment. The plot consists of five different areas:

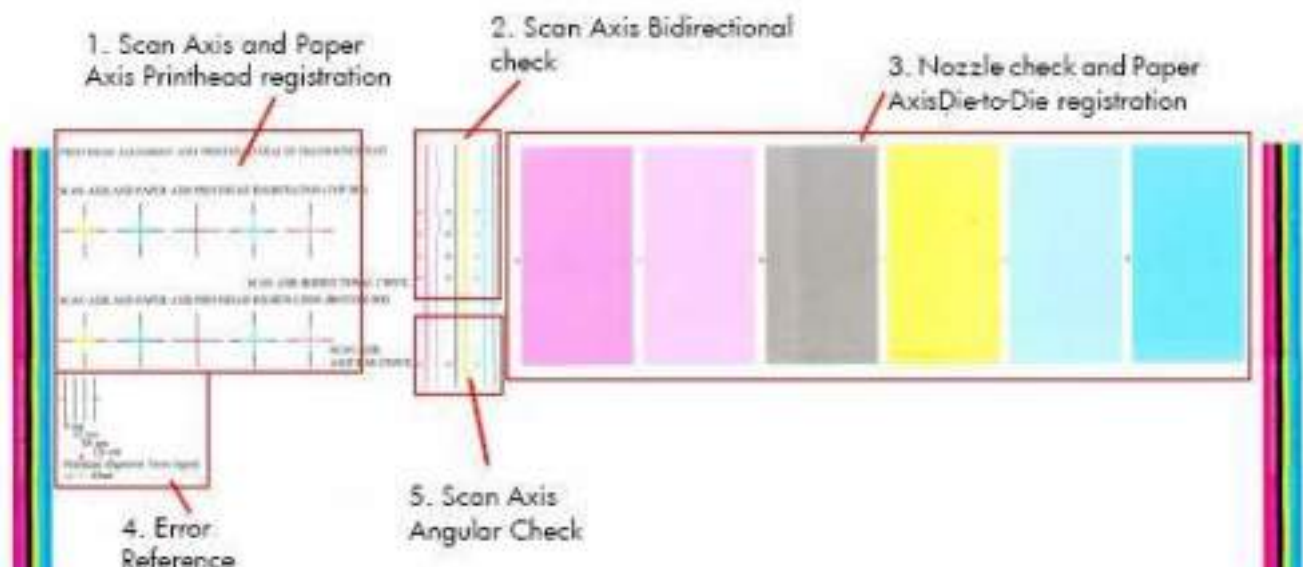

1. Scan Axis and Paper Axis Printhead registration

The colored crosses of the plot should show lines perfectly aligned with each other, as shown below.

The die 1 and die 2 of the black printhead is used as a reference to which the rest of the pens are compared. The substrate does not move while the pattern is being printed.

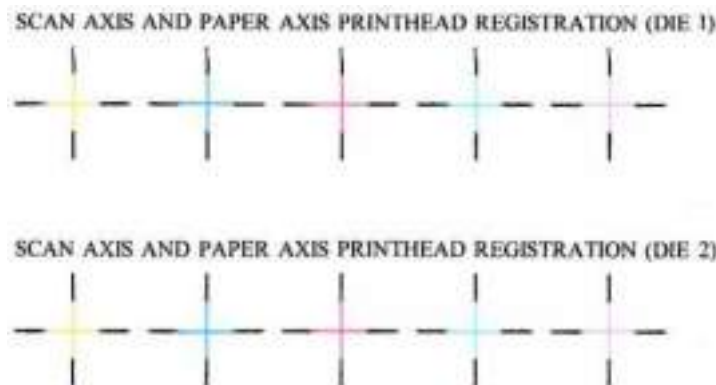

If the Printer is experiencing **horizontal** misalignment problems, the Alignment Test will print the lines in the orientation shown below (A). If the Printer is experiencing **vertical** misalignment problems, the Alignment Test will print the lines in the orientation shown below (B):

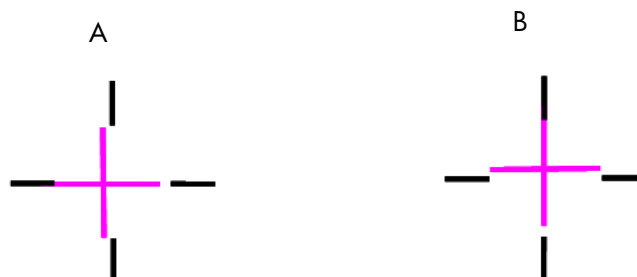

2. Scan Axis Bidirectional check

The small arrows point to the place where lines printed in forward and reverse directions meet. It is at this point that the registration accuracy must be checked.

The check should be done for the M-Lm, KY and C-Lc printheads. The bidirectional alignment can change slightly as the substrate thickness varies.

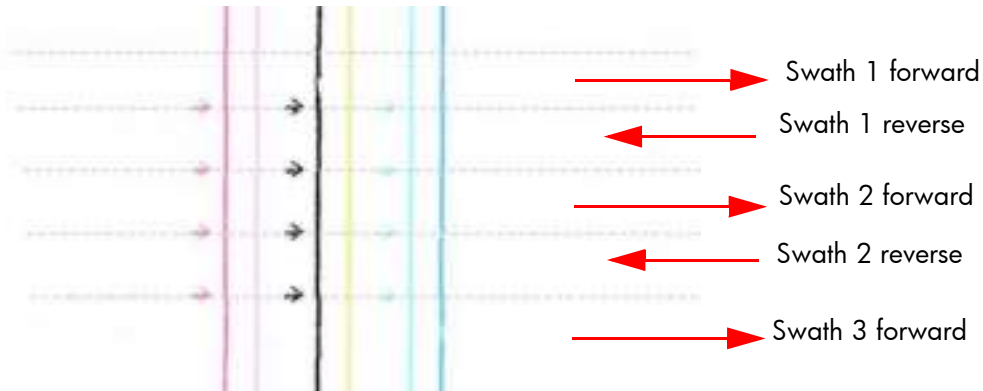

The plot should show lines perfectly aligned with each other, a straight vertical line indicates correct bidirectional alignment (A). If any of the printheads are experiencing bidirectional misalignment issues, the alignment test will print the lines as show below (B).



3. Nozzle check and Paper Axis Die to Die Registration

The colors are printed with a halftone, low-ink area fill, in a one pass printmode.

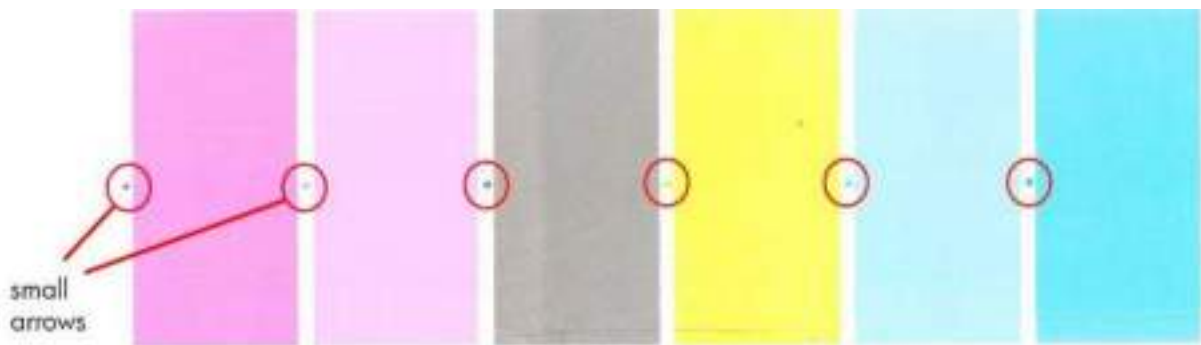

The small arrows point to the place where two different printhead dies meet. No significant light or dark lines should be seen at this point. Manual Alignment reset the alignment back to factory defaults.

The patches also provide a basic judgment about the printhead nozzle status. Horizontal bands indicate weak or missing nozzles.



NOTE: If there are many horizontal bands indicating weak or missing nozzles, the die to die registration test will be a poor indicator of the status of the die to die registration. If this occurs clean the printheads and reprint the test.

4. Error reference

The plot contains a reference marked 'Legend', this is a guide to deciding if any of the printhead registrations are correct or incorrect.

- The correct/incorrect criteria shown here corresponds to a plot with a maximum IQ (usually printed on high quality substrate such as vinyl). Other substrates and usage may accept significantly worse registrations while still producing an acceptable level of image quality.
- Automatic printhead alignment may not produce optimal registration under certain conditions. Substrate texturing, elasticity and the behavior of the substrate under different temperatures may lead to some imperfections with regards to printhead registration. In these circumstances the user may choose to use the Manual Printhead Alignment instead.

Correct Incorrect

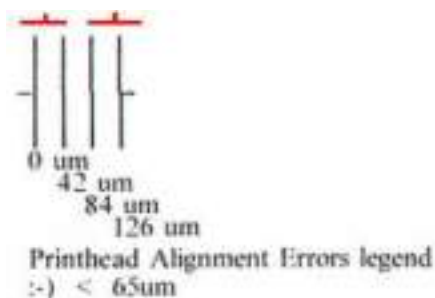

5. Scan Axis Angular Check

The small arrow point to the place where the lines printed in subsequent passes meet using unidirectional printmode. The registration must be checked at that point. The check should be done for the MLm, KY and CLc printheads. Note that the substrate advances between the upper and lower parts of the plot.

This test mainly relies on the changing surface of the substrate. Problems in the angular alignment lead to pen to pen misregistration. This is because of the staggered orientation of the printheads.

The angular alignment can differ slightly when the type of substrate varies, or when the substrate has recently been loaded.



Corrective Action

1. Perform a Printhead Alignment. Use the same type of paper that the customer was using when there were image quality printing issues. However it should be noted that some paper types are not suitable for the Printhead Alignment.

2.4.1 Printheads Health Test Plot

To print this test plot go to Menu List>2. Image Quality Plots>2.4 Printheads Health>2.4.1 Print Test Plot. The printhead health test plot is designed to enable you to see the overall health of the printhead nozzles.

The nozzles check (bottom of the plot) is printed in a one-pass full swath mode. The diagnostics test prints out every single nozzle of each Printhead without applying an error hiding or alignment algorithm.

For each Printhead, you can see both the adjacent and the consecutive nozzles. For every Printhead there is a different horizontal band that can be identified with the help of the template marked with the colors of the Printhead used at the right of every band.



There are a series of numbered stepped diagonal lines. If one or more of the nozzles are malfunctioning or mis-positioned, you will see that the stepped lines are broken or misdirected in one or more places.



In this example of the plot the print shows a nozzles health pattern without any failing nozzles. In this case, the case shown corresponds to the black color.



This is an example of nozzles out. You can see the broken or the skewed line, in this case marked in yellow to help you to understand the issue. In the service plot there are no yellow marks.



This is an example of nozzles mis-positioned or malfunctioning. You can see the broken or the skewed line, in this case marked in yellow to help you to understand the issue. In the service plot there are no yellow marks.

For a more in-depth view of the health of the nozzles you can print the Advance Nozzles Health test plot.

Corrective Action

If the printer has nozzle defects, acceptable print quality results can still be achieved because the Printer can automatically compensate for this, there is no need to replace the Printhead because of nozzles out.

The method of improving Nozzle Defects is to:

1. To clean the printheads, go to the printer's front panel and select the ink menu, then Image quality maintenance > Clean printheads. Select which printheads you need to clean. You can clean all of the printheads or only some of them. The selections available are:
 - Clean all
 - Clean M-LM
 - Clean C-LC
 - Clean K-Y
2. Reprint the Printhead Nozzles Test Plot to verify that the defective nozzles have been corrected.
3. If the problem persists, replace the defective Printhead.

2.3.2 Substrate Advance Test Plot

Printing direction
(paper axis)



Left plot



Center plot



Right plot

To print this test plot go to Menu List>2. Image Quality Plots>2.3 Substrate Advance>2.3.2 Print Adjustment Plot.

The Substrate Advance Test Plot enables you to visually determine the accuracy of the media advance, if there are any advancement issues they will appear in this diagnostic plot.

The plot can be used to precisely measure the media advance error with a one dot row accuracy or 2.85mm per meter, and to verify the stability of the media advance. In addition, the test is performed on the left, center and right side of the scan axis. This is to verify any differential advance due to an uneven advancement of the substrate.

Each sample is composed of 9 vertical columns named -4 to 4. Each single column represents an advance deviation of 2.85mm per meter, so column -4 is related to a deviation of -11.42mm per meter and 4 corresponds to +11.42mm per meter. The advance obtained along the scan axis direction corresponds with the position of the lighter portion of the pattern in each advance, as shown on the next page.

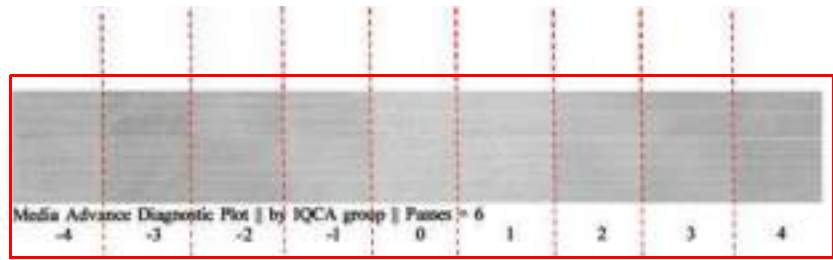

A perfectly calibrated printer will show a straight vertical lighter line in the 0 column. If the lighter line is printed in any of the other columns, this would indicate there is a constant advance offset along the entire plot. If the offset is bigger than $\pm 2.95\text{mm}$ per meter (the lighter column is not the center one), this can be adjusted by using the button on the front panel to change the compensation of the substrate advance as the printer prints.

It is very important to verify that the substrate selected on the front panel, is the same as the actual substrate loaded on the printer. You can verify the substrate type selected through the Front Panel (Main Menu>Paper Menu>View Loaded paper). If an incorrect substrate is selected, this will produce an offset error in the Paper Advance.

Corrective Action

The figure shown here (left) shows a vertical lighter shaded line placed at column -3, which indicates an offset of 8.57mm per meter.



This can be adjusted by using the button on the front panel to change the parameters as the printer prints.

- If the lighter line is in the negative column, increase the compensation of the substrate advance.
- If the lighter line is in the positive column, decrease the compensation of the substrate advance.

When the lighter shaded line is in position 0, the process is complete.

If the advance is not a straight line, this would indicate that the printer has a variable advance error.

If this is the case verify the following:

- Check to see if the OMAS is clean, if it is not clean the OMAS and reload the substrate and repeat the diagnostic plot.
- Check that the OMAS is functioning correctly. Check the light in the OMAS blinks while the substrate moves while an image is being printed.
- Check that the OMAS can function correctly with the type of substrate loaded. If it cannot, for example with high gloss substrate, disable the OMAS from the RIP and reprint the diagnostic plot.



2.4.2 Advanced Printhead Health Test Plot

The Advanced Printhead Health Test Plot is not part of the large diagnostic print, but it is similar to the Printhead Health Test Plot described previously. With this plot however you will be able to identify which of the Printhead Nozzles is actually failing. To print this test plot go to Menu List>2. Image Quality Plots>2.4 Printheads Health>2.4.2 Advanced Test Plot.



This plot, like the normal nozzles health test, prints in a special one-pass full swath mode, but unlike the normal nozzle health test, only a few of the nozzles are printed at once and with small incremental media advances. Eventually all the nozzles of all the printheads are printed, this means printing the plot can take longer than the normal health test.

The plot is intended for visual inspection only. The plot consists of three blocks. For each printhead, there is a different block, which can be easily identified by the colors of the printhead used inside and/or the template located on the right side. Each block is split horizontally into two areas that correspond to the colors in the printhead. Vertically, the block is split into sections that correspond to two dies combining the two staggered printhead of each color (see graphic below).

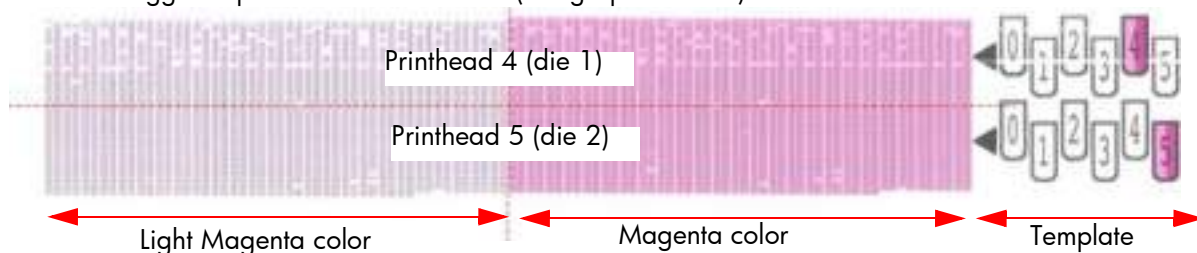

Each single region is composed of a series of numbered triangles. Each rectangle is related to a single nozzle in the printhead. If one or more of the nozzles are malfunctioning or mispositioned, you will see that the rectangles are not filled. The corresponding color and the number printed inside can be read.

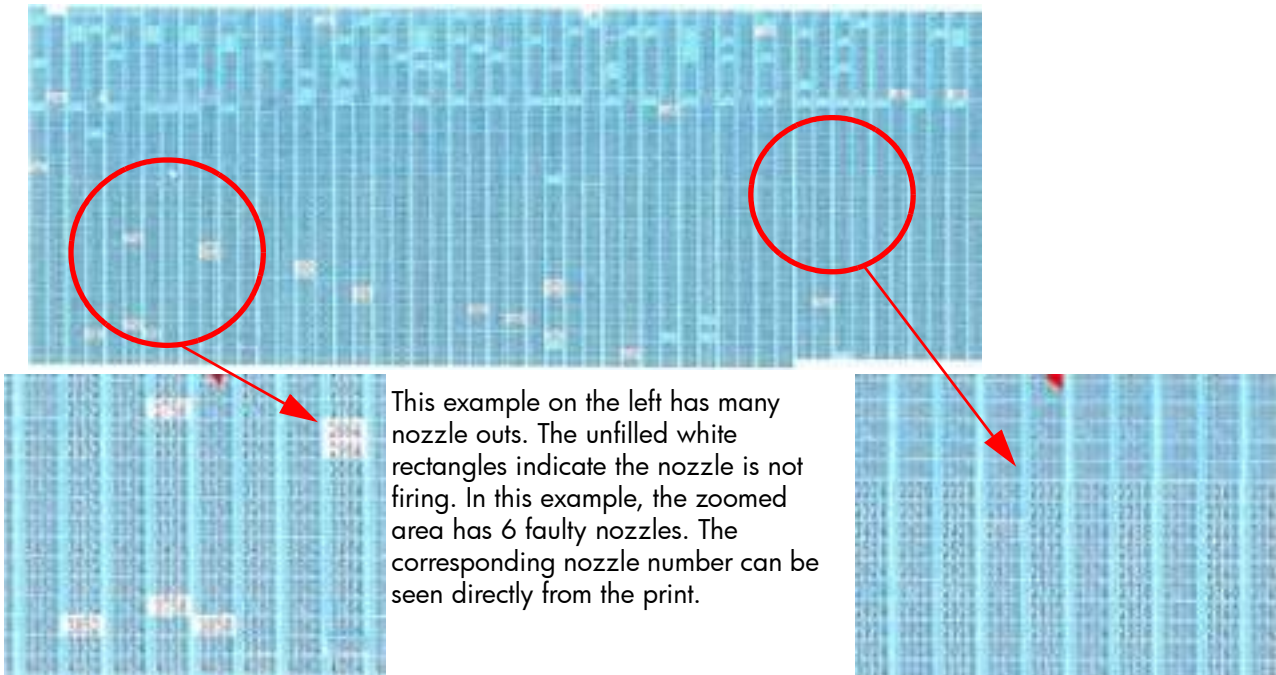

This example on the left has many nozzle outs. The unfilled white rectangles indicate the nozzle is not firing. In this example, the zoomed area has 6 faulty nozzles. The corresponding nozzle number can be seen directly from the print.

This is an example of good nozzle health. All rectangles are perfectly filled with the printhead's color.

Corrective action

If the printer has nozzle defects, the level of image quality achieved can still be considered acceptable because the Printer can automatically compensate for this, there is no need to replace the Printhead because of nozzles out.

A single die for a single color can contain up to 70 nozzles out and still the print quality will not be significant degraded.

1. Perform a clean of the printheads
2. If there is still any die above the threshold level (70 nozzles out), perform a hard clean process.
3. If the a hard clean has improved the number of nozzle that have been recovered, perform the hard clean again.
4. If there are any dies that have more than 70 nozzles out per die, replace the printhead.

2.2.2 Advanced Alignment Diagnostic Print

This plot helps you to visually check any alignment problems of the printer, it is similar to the process already described on ⇒ Page229, but in more detail. You use it to precisely measure the alignment error with a one dot row accuracy. To print this test plot go to Menu List>2. Image Quality Plots>2.2 PH Alignment Menu>2.2.2 Advanced Test Plot

The plot is split into two main areas. The area upper area contains the area which checks the pen alignment, while the bottom area checks the same color staggered pen overlap.

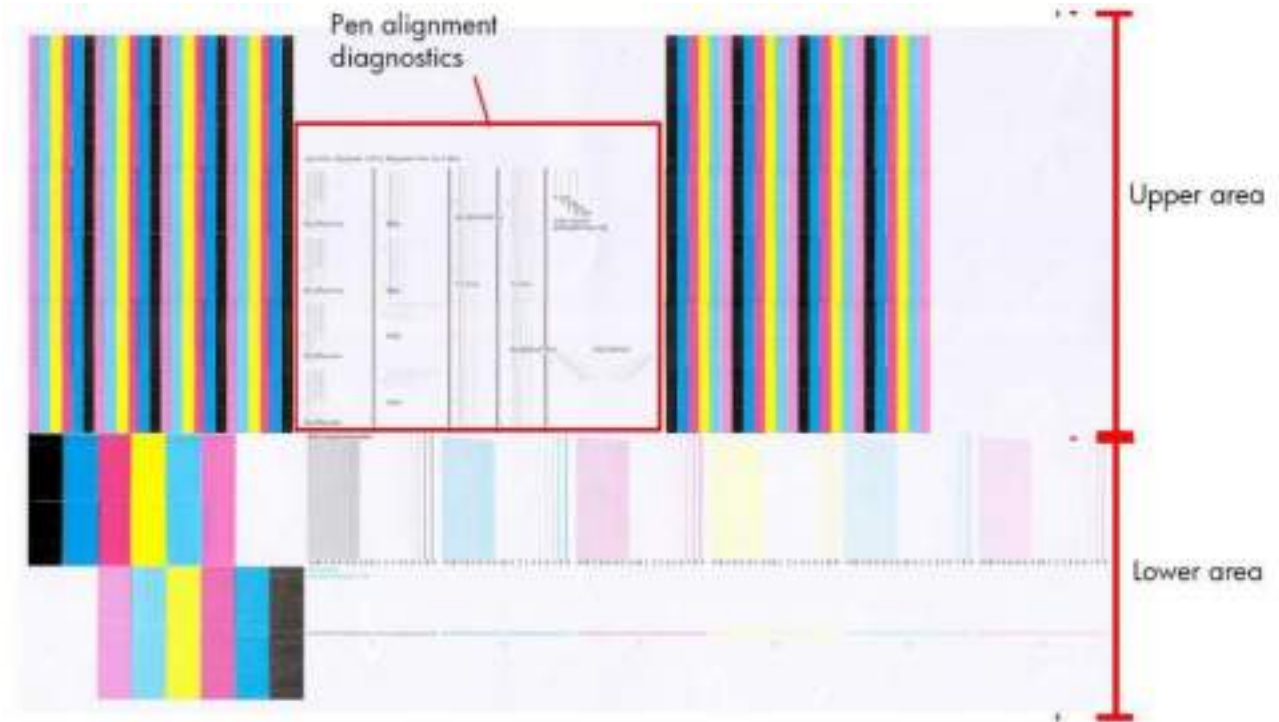

Pen Alignment Diagnostics

The Pen alignment Diagnostics, shown in the red box above, consists of various areas to check the alignment:

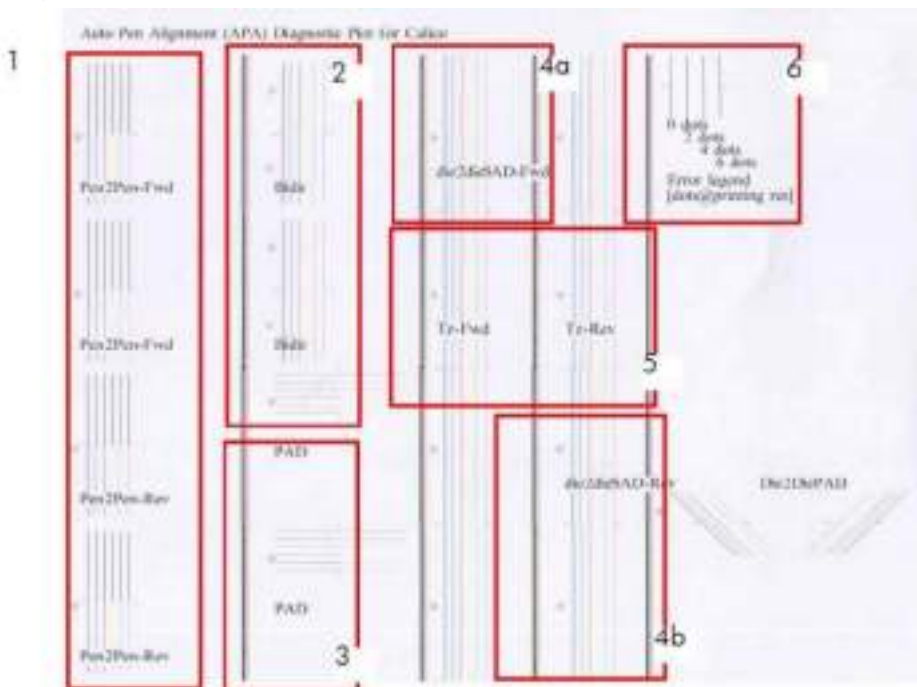

1. In this area there are four checks for the pen to pen alignment in the scan axis direction (Pen2Pen-Fwd or Pen2Pen-Rev). It is forward and reverse.
 - The top pattern is related to the front printhead (nearest to the user when doing the pen replacement).
 - The bottom pattern is related to the rear printhead (furthest from the user when doing the pen replacement).

The area to check is the junction (marked with a "-") of the black with the rest of colors.

2. The bidirectional check is at the top, marked as Bidir.
 - a. The top pattern is related to the front printhead (nearest to the user when doing the pen replacement).
 - b. The bottom pattern is related to the rear printhead (furthest from the user when doing the pen replacement)

Check that the lines are continuous without a gap. The junction is marked with a "-"

3. The pen to pen alignment in paper advance direction (PAD) is marked as number 3.
 - a. The top pattern is related to the front printhead (nearest to the user when doing the pen replacement).
 - b. The bottom pattern is related to the rear printhead (furthest from the user when doing the pen replacement)

The area to check is the junction (marked with a "-") of the black with the rest of colors.

4. The alignment in the scan axis direction between both printheads of the same color is marked as 4a (in forward direction die2dieSAD-Fwd) and 4b (in reverse direction die2dieSAD-Rev).

The area to check is the junction (marked with a "-"). The lines have to be continuous.

5. The ThetaZ of the printhead are checked in the area marked as 5. It checks in forward (Tz-Fwd) and reverse direction (Tz-Rev).

The area to check is the junction (marked with a "-"). The lines have to be continuous.

6. The area marked as number 6 is a reference legend that shows junction misalignments of 2, 4 and 6 dots. The junction to check has to be below 4 in all the cases. If the error seems to be above 4 dots, then realign the printheads again.

Die Overlap Alignment.

The Die Overlap alignment is at the bottom of the plot. The area to check is only the bottom junction pattern for all the colors. The clearest band must be around the 0 (± 3 dots). Every band is equal to a one dot error.



Corrective action

In order to solve any problem in the alignment, perform the following:

- Repeat the printhead alignment. Most recommended papers are glossy papers where pen alignment accuracy is best. There are some paper types that are not suitable for Printhead Alignment (transparent, translucent)
- Try cleaning the Printheads if the error continues.
- If the error persists, replace the affected printhead.
- If there is an issue in the ThetaZ and it cannot be fixed, check if the paper is working with the OMAS sensor. There are some papers that cannot be controlled by the OMAS sensor. If the paper is a type that should work with the OMAS sensor, check the functionality of the sensor.

2.4.3 Plot for escalation only

To print this test plot go to Menu List>2. Image Quality Plots>2.4 Printheads Health>2.4.3 Only For Escalations. There are two identical plots to this test and each plot has three parts to it. The first plot refers to the rear printheads (number 1, 3, 5), while the second plot refers to the front printheads (2, 4, 6).



This plot is only printed at the request of the HP Division, or in case further help is required and there is need to escalate an image quality issue to HP Division.

2.5 Geometry Check

The Geometry check print test is a simple template designed to check the printer's length accuracy and figure distortion performance. To print this test plot go to Menu List>2. Image Quality Plots>2.5 Geometry Check.

If a customer complains that there is an issue with a plot they are printing, this standard template can be printed and referred to by both the customer and HP as a single point of reference.

The plot consists of a 7x7 matrix of rectangular boxes. By default, each single rectangle corresponds to a DIN A4 sheet size (210mm x 297). Based on this, the total printed plot length should be about 2.07 meter (approx. 82") and 1.47 meters (approx. 58"). However the actual dimensions will highly depend on what settings have been defined for the Media Advance.

Each point in the matrix can be identified by means of a letter in the X axis and number in the Y axis. There is an arrow in the plot close to the point 'A1' to show the printing direction.

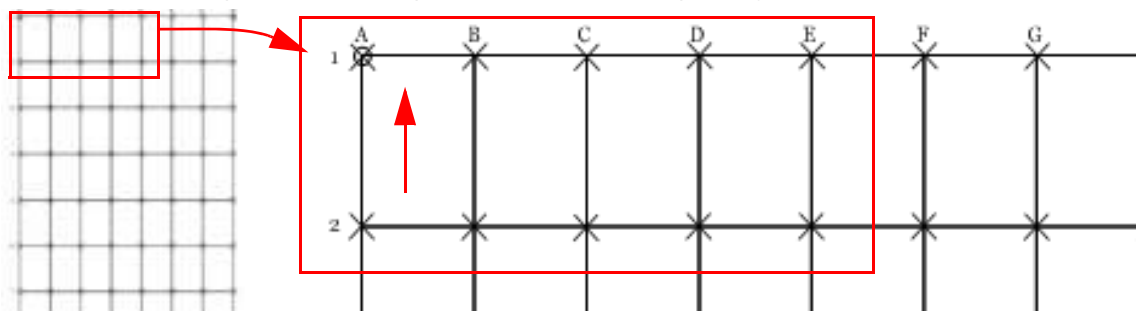

The method of evaluating the geometric performance is the following:

1. Select an area on the matrix to evaluate for accuracy and dimensional integrity. The template is designed so you can measure anything from an A4 sheet upwards to any probable dimension.
2. Place the printed plot on a flat surface. This will minimize any wrinkles before proceeding with the process.

3. Find the vector length accuracy by selecting parallel vectors and/or figure distortion by measuring the diagonals in the selected area.
4. Note the measurements to assess the printer's performance. It will help to keep the measured vectors identified by using the name convention marked on the plot i.e. A1, A3. This makes it easier to identify exactly the areas of the plot where the measurements were taken.



NOTE: To check if a printer complies with the technical specifications, please refer to 'Line accuracy' section in the printer's data sheet.

NOTE: After loading media, allow the media to stabilize before printing the plot. Some types of media require up to 3 meters before it is stabilized.

Corrective Action

1. Reload the media following the exact steps from the User's Manual.
2. In some cases, differences in the media advance along the scan axis could cause geometric defects. Try adjusting the settings in the RIP. Adjust Vacuum level and Backtension levels. Be careful when adjusting these settings, refer to the RIP supporting documentation for further details of this type of adjustment.

3.1 Inks on Substrate Test

The Inks on Substrate Test plot is used to determine the level of performance of the Drying and Curing Assemblies and to determine if they are performing as expected. To print this test plot go to Menu List>3. Inks On Substrate Test>3.1 Print Ink Test Plot.

At the beginning of the plot is an area used to stabilize the printing system before the diagnostic print is printed, this area can be ignored. The diagnostic area of the print contains colored blocks representing each of the primary and secondary colors, the plot shows a scale from lighter to darker intensity (amount of ink). The plot is printed with a 10 pass print mode.

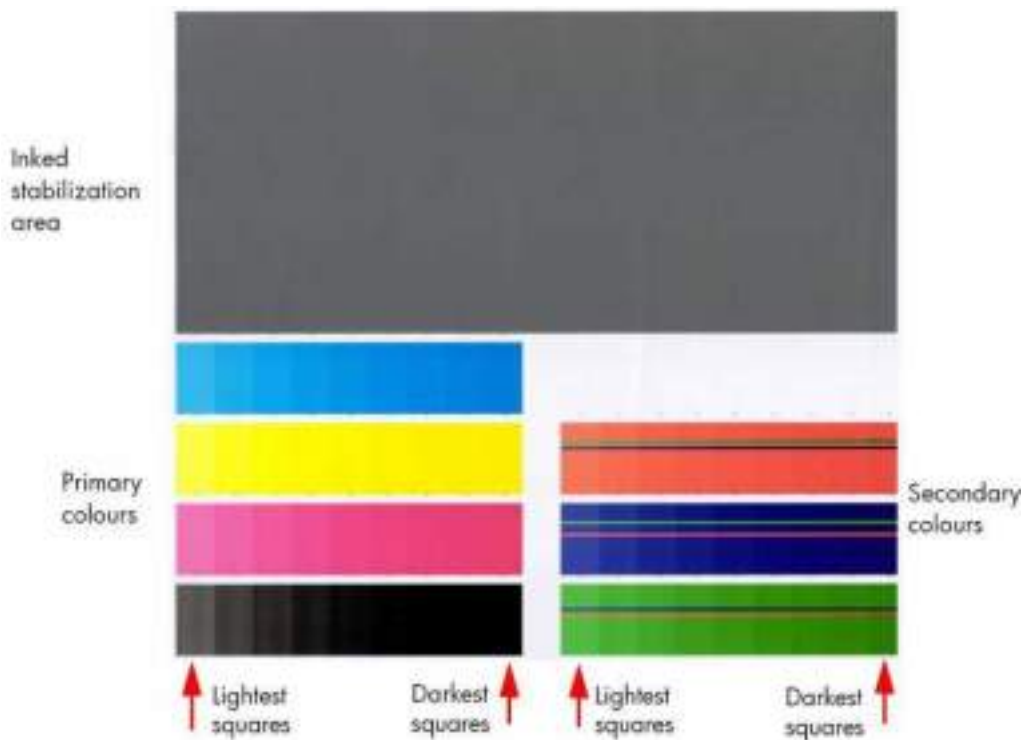

To evaluate the **Drying** test plot look at the last square (in order of increasing ink quantity) that shows no coalescence, banding or bleed effects.

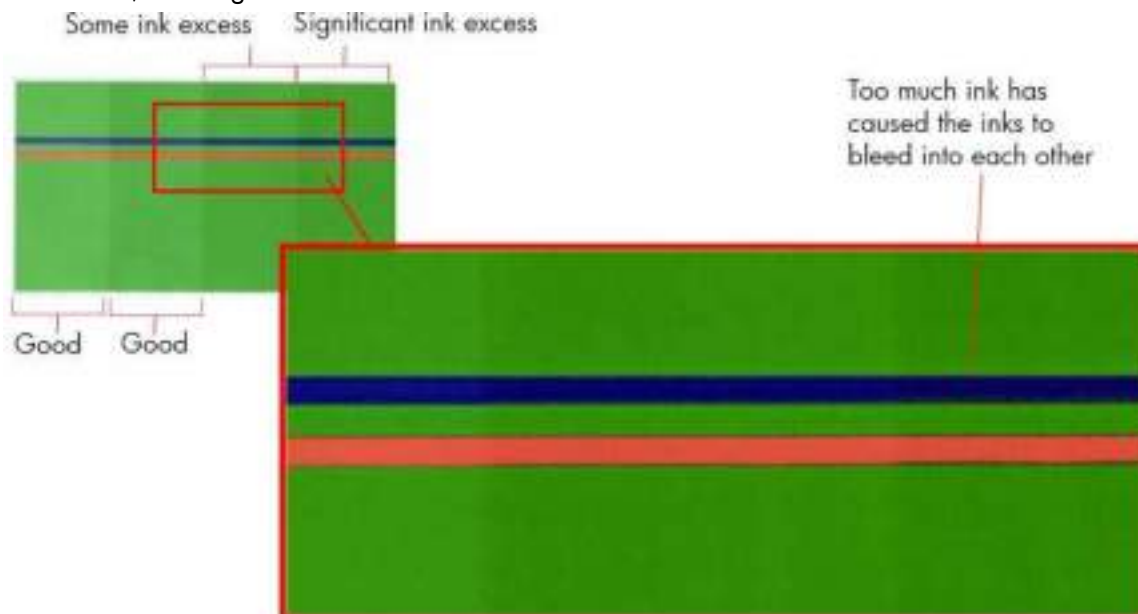

To evaluate the **Curing** test plot look at the squares that show ink smudge when touched (see picture) or that show an 'oily finish' (which is more likely).

The following table shows the maximum quantity of ink (the darkest patch) that can be printed using **HP Permanent Gloss Adhesive Vinyl** without producing any of the issues previously stated. The evaluation is performed in the secondary colors only:

Color	Coalescence	Bleed	Curing defects
R	200%	116%	200%
G	100%	116%	200%
B	100%	116%	200%

Corrective Action

At the bottom of edge of each block of primary color, and at the top of each secondary color, there is a percentage scale which indicates the level of ink used to print that portion of the diagnostic print. This information can be used to adjust the ink saturation levels in the RIP used by the customer.

2.6 Scan Axis check

This plot shows any defect in the Encoder Strip along the Scan Axis. To print this test plot go to Menu List>2. Image Quality Plot>2.6 Scan Axis Check.

Any defects in the encoder strip will have a detrimental affect on the image quality of the printer, specifically in the area where the encoder is defective. The defect is revealed by means of an interference or Vernier pattern that spans the whole Scan Axis of the printer.

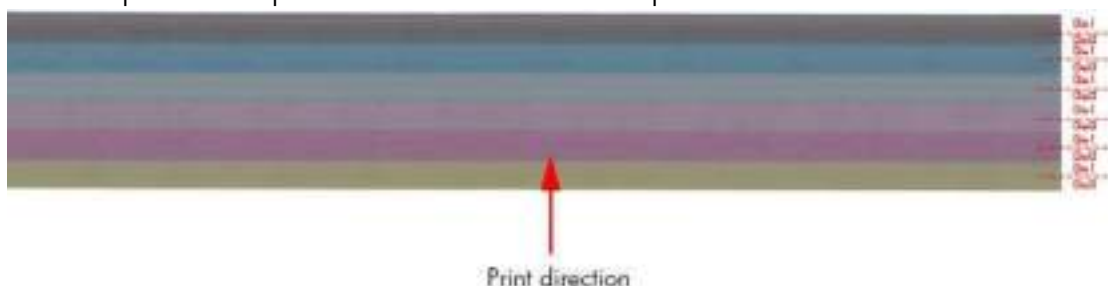

The test plot consists of six horizontal color bands with a black pattern mask on top of them. Each band is split in to two horizontal areas corresponding to the die 0 and die 1 for the specific color. The plot is printed in unidirectional mode at 40ips.

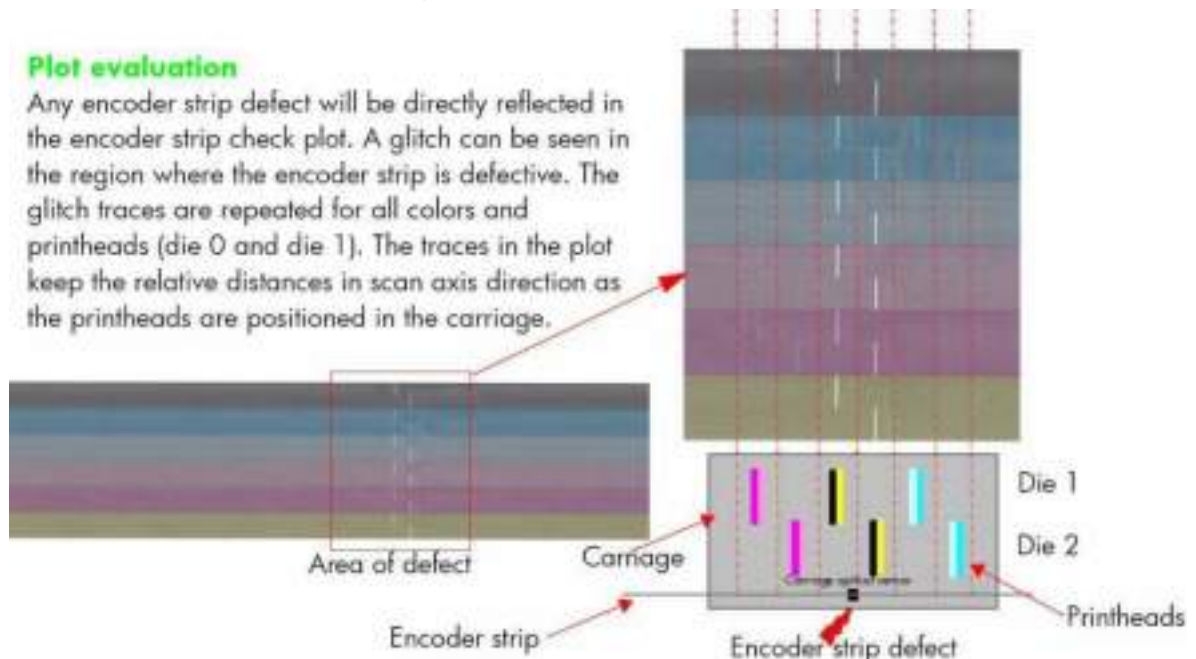

Corrective action

If an fault is found with the encoder strip, replace the Encoder Strip ⇒ page 399.

Force Drop Detection

If the Printhead Health test plot (⇒ page 231) has persistent white point banding in only one color that cannot be fixed with a recovery, you can use this option to resolve the problem by resetting the nozzle health data base so that all nozzles are assumed to be correct. After the nozzle health data base has been reset, the drop detection procedure is started ⇒ page 192.

The normal cause of this white point banding in a single color is the failure of the drop detector to correctly detect nozzles pot on the printhead.

This tool is also helpful to diagnose a potential failure of the drop detector. The 'force drop detector tool' displays the number of nozzles out per printhead. If you print the diagnostic plot image, afterwards you will be able to compare this number detected by the drop detector with the real number of nozzles out that you see on the printout.

If there is a mismatch on all the colors, this would probably indicate that the drop detector is not working correctly or is mispositioned. Before replacing the drop detector, perform a 'drop detector calibration' ⇒ (page 216) to correctly position it. If the failure (miss-match) is still there after the calibration, replace the drop detector.

Substrate advance issues

The vast majority of issues concerning the advancement of the substrate can be solved by asking the customer to clean the 'Substrate-advance sensor window'. This procedure is described in the customer document 'Maintenance and Troubleshooting Guide'.

If after performing this, the customer is still experiencing image quality issues related to the advancement of the media, use the following procedure.

1. Make sure the window of the OMAS sensor located in the Platen has been completely cleaned of all ink, the cleaning swabs provided to perform this procedure must be used.
2. Some types of substrate cannot be used with the OMAS sensor, because they are too smooth or there is too much light reflected from the substrate surface to be able to be read by the OMAS, examples of these types of substrate are: Clear Film, Backlit, types of Matte film, types of Polypropylene. Check the troubleshooting procedure on the next page to determine if the error is with the OMAS or the Substrate being used. If the error is with the substrate, there are two options:
 - Change the type of substrate to a type that can be used with the OMAS, ideally it will be a substrate with a readable surface, such as a self adhesive media, the type with a removal backing.
 - Disable the OMAS, and use the analog device to control the substrate advancement.
 - To disable OMAS, go to Service Test Menu > 1.3 Media Path Menu > 1.3.3 Enable/Disable OMAS. Refer ⇒ Page 189
 - Perform the Substrate Advance Calibration select the (ink) icon on the Front Panel, and then select 'Image quality maintenance > Substrate Advance calibration > Print adjustment plot, refer to the Maintenance and Troubleshooting guide.
3. Perform the 'OMAS Sensor Check' to check the electrical functionality of the OMAS ⇒ Page 189.
If the OMAS Sensor fails the check, replace the OMAS Sensor ⇒ Page 424.
4. Perform the 'TOMAS Sensor Check' to check the electrical functionality of the TOMAS ⇒ Page 189.
If the TOMAS Sensor fails the check, replace the TOMAS Sensor ⇒ Page 424.

Advance error with the Substrate or with OMAS?

^a List of types of media which are NOT used (non navigable) by the OMAS media sensor:

HP or HP Approved Clear Film

HP or HP Approved Backlit

HP or HP Approved types of Matt film

HP or HP Approved types of Polypropylene

A non HP or HP Approved Media

^b In order to perform this Calibration, you should order the Paper Advance Calibration Kit (Part Number Q1273-60296) which contains two cut sheets of HP Universal Instant-dry Gloss Photo media (36-inches wide by 42-inches long).

^c 'OMAS Blinking' means that the red LED in the OMAS lens blinks ON/OFF during paper advance when OMAS is operating.

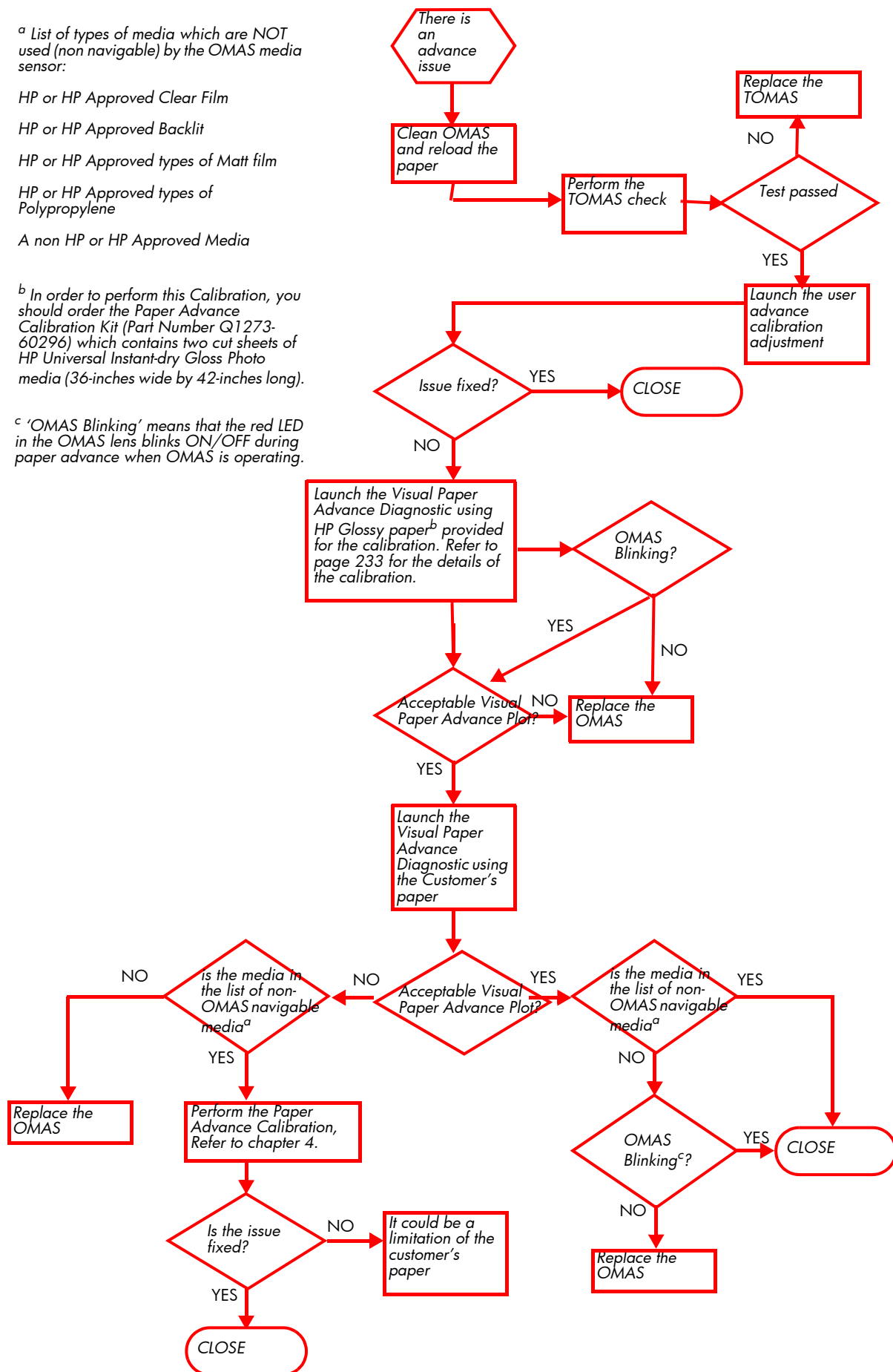

6 Ink Supplies

- What are Ink Supplies?.....248
- General Information About the Ink Supplies250
- General Precautions When Handling Ink Supplies 251
- Priming the Ink System 251
- When Should You Replace the Ink Supplies? 251
- "Obtaining Ink Cartridge Information".....252
- Obtaining Printhead Information253
- Troubleshoot Ink Cartridge and Printhead issues256
- The Front Panel recommends replacing or reseating a Printhead257
- Warranty Information for Ink Supplies259

What are Ink Supplies?

For each of the six ink colors used in the printer, there are three separate components, the Printhead, the Maintenance Cartridge, and the Ink Cartridge. All of these components are called Ink Supplies.

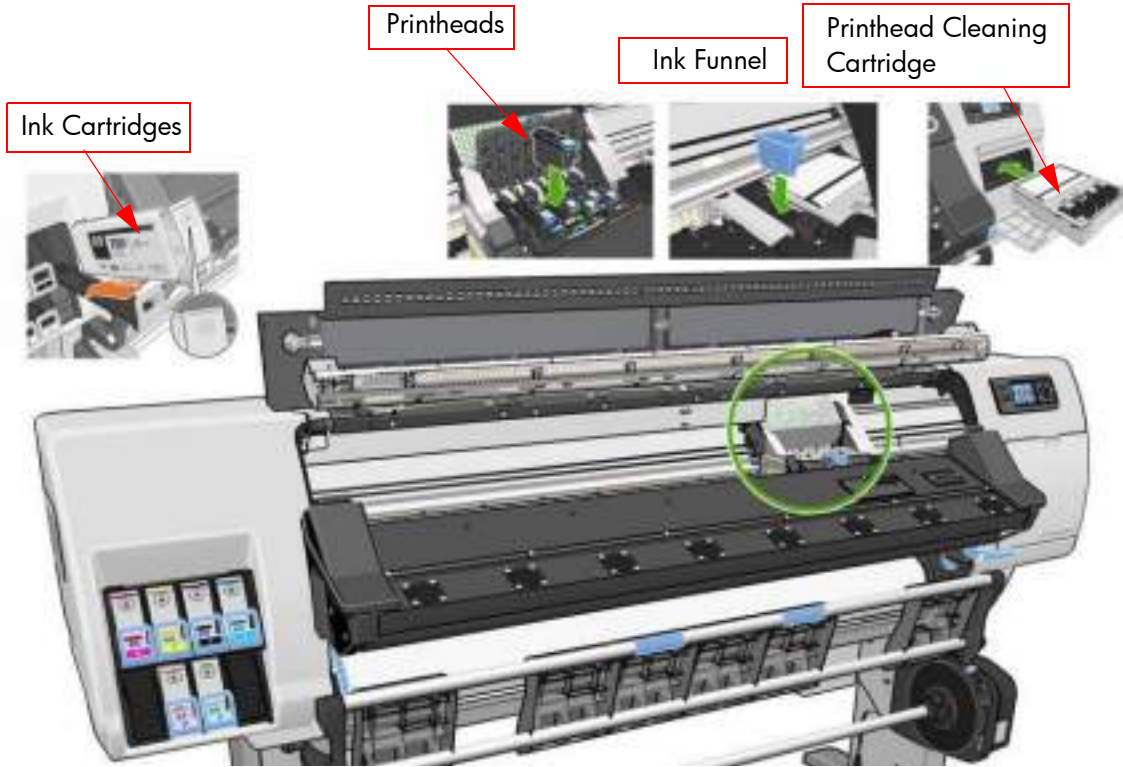

Ink Supplies

Printheads	CPL Description	Full Description
CH612A	HP 789 Yellow/Black PH	HP 789 Yellow/Black Designjet Printhead
CH613A	HP 789 Cyan/Light Cyan PH	HP 789 Cyan/Light Cyan Designjet Printhead
CH614A	HP 789 Lt Magenta/Magenta PH	HP 789 Light Magenta/Magenta Designjet Printhead
Ink Cartridges		
CH615A	HP 789 775ml Blk Ltx Designjet Ink Crtg	HP 789 775ml Black Latex Designjet Ink Cartridge
CH616A	HP 789 775ml Cyn Ltx Designjet Ink Crtg	HP 789 775ml Cyan Latex Designjet Ink Cartridge
CH617A	HP 789 775ml Mag Ltx Designjet Ink Crtg	HP 789 775ml Magenta Latex Designjet Ink Cartridge
CH618A	HP 789 775ml Yelw Ltx Designjet Ink Crtg	HP 789 775ml Yellow Latex Designjet Ink Cartridge
CH619A	HP 789 775ml LtCn Ltx Designjet Ink Crtg	HP 789 775ml Light Cyan Latex Designjet Ink Cartridge
CH620A	HP 789 775ml LtMg Ltx Designjet Ink Crtg	HP 789 775ml Light Magenta Latex Designjet Ink Cartridge
Maintenance Materials		
CH621A	HP 789 Designjet Printhead Cleaning Kit	HP 789 Designjet Printhead Cleaning Kit
CH622A	HP 789 Designjet PH Cleaning Container	HP 789 Designjet Printhead Cleaning Container

Ink Cartridges

The printer's six Ink Cartridges provide yellow, magenta, light magenta, light cyan, cyan, and black ink to the Printheads. There's NO Introductory Ink Cartridges supplied with the printer. The 'Host' Ink Cartridges which are purchased hold approximately 775ml.



The Ink Cartridges for the HP Designjet L25500 Printer series require no maintenance or cleaning. As long as each Ink Cartridge is inserted correctly into its slot, the ink will flow to the Printheads. Because the Printheads control the amount of ink transferred to the page, you will continue to see high-quality printing results even when the ink levels are getting low.

The front panel displays the status of the Ink Cartridge. Using the front panel, detailed information can be checked on the Ink Cartridges menu.

Printheads

The printheads are connected to the ink cartridges. They use jet action to put ink on the paper. Each printhead has two ink cartridge connection points and two jet nozzles, which means that each printhead accommodates two ink cartridges. For example, the following printhead image indicates a printhead that draws and jets ink from the magenta and yellow cartridges.



The Printheads are extremely durable and do not need to be replaced every time an Ink Cartridge is replaced. They are independent of the Ink Cartridges and will continue giving excellent image quality results even if the Ink Cartridges are low on ink.

Printhead Cleaning kit

Use the Printhead cleaning kit to clean and maintain the Printheads, ensure the best possible print quality, and seal the Printheads when they are not in use to prevent them from drying out.

The Printhead cleaning kit for the HP Designjet L25500 Printer series is the HP 789 Printhead cleaning kit P/N CH621A. It consists of two main items: Printhead Cleaning Cartridge and Ink Funnel.

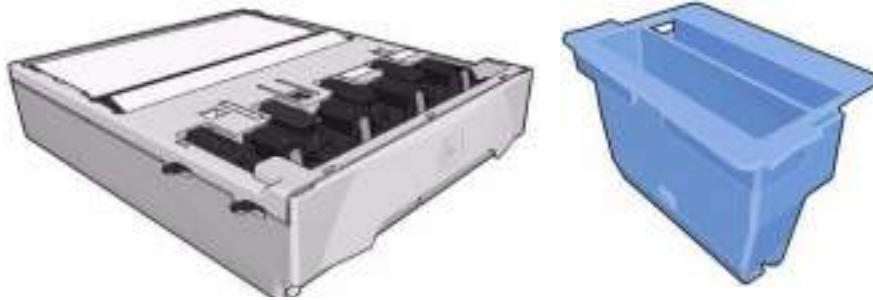

Printhead Cleaning Container

In order to check the status of the printhead nozzles, the printer expels a few drops of ink from each nozzle of each printhead into printhead cleaning cartridge and container. This is done at the start of each print job, during printing, whenever a printhead is replaced, and whenever you request a printhead check.

The Printhead cleaning container for the HP Designjet L25500 Printer series is the HP 789 Printhead Cleaning kit P/N CH622A.



General Information About the Ink Supplies

For optimum results from the printer and modular ink delivery system always follow these guidelines when handling the ink supplies:

- Install the Ink Cartridges, Printheads, and Maintenance Cartridge before the install-by date, which is printed on the packaging. The expiration for the Ink Cartridges is the manufacturing date marked on the cartridge plus 30 months.
- Allow the Printer and the Maintenance Cartridge to automatically clean the Printheads.
- Follow the instructions on the front panel of the Printer during installation.
- Avoid unnecessary removal of the Ink Cartridges and Printheads.
- When turning off the Printer always use the power Off button on the front panel. The Printheads are then stored correctly which prevents them from drying out.
- The Ink Cartridges should never be removed while the printer is printing. They should only be removed when the printer is ready for you to replace them. The front panel will guide you through the removal and installation procedure.

General Precautions When Handling Ink Supplies



CAUTION: Do not touch, wipe or attempt to clean the printhead nozzles. This can damage the printhead.

- Handle the ink supplies with care. In particular the Printhead, which is a high precision device and must be handled carefully.
- Do not touch the Printhead nozzles.
- Do not put the Printhead down on the nozzles.
- Do not be rough when handling the Printheads. Always set them down gently.
- Do not drop the Printheads.
- Proper handling will assure optimum performance throughout the Printhead life.
- The Maintenance Cartridge should always be handled and stored upright to avoid a potential spillage of ink.
- Do not touch the end of the Ink Cartridge which is inserted into the printer as there may be a small amount of ink on the connection.
- Avoid storing partially used Ink Cartridges on their ends.

Priming the Ink System

When the customer first receives the printer, it is supplied with a set of six Setup Printheads pre-installed in the Carriage Assembly. These Setup Printheads are used for the priming of the tubes in the modular ink delivery system. Do not remove the Setup Printheads from the Carriage without following the procedures in the *Setup Guide*.

When the Printer is powered ON for the first time, the Printer will automatically perform the priming process. Without the priming process, the customer will NOT be able to use the Printer.

Why does the Printer require priming:

- The Tubes System is empty when the customer receives the Printer.
- The Tubes System has to be pressurized and filled with ink, ejecting any air bubbles.



CAUTION: If the Printing Printheads are installed in the carriage during the priming process, they will be rejected and the front panel will show a warning message.

When Should You Replace the Ink Supplies?

When to change the ink supplies is mostly determined by you with guidance from the front panel. In conjunction with the messages displayed in the front panel and the message explanations in this chapter, you will be able to choose for yourself when is the right time to change the ink supplies.

The Printer will also display the ink level and will tell you when the ink supply is low on ink. This means you have constantly updated information about the ink supplies.

Printhead guaranteed life is 1000 ml although the printheads usually last much longer. See the section about the 'Warranty Information for Ink Supplies' page 259.

“Obtaining Ink Cartridge Information”.

Use the following procedure to obtain Ink Cartridge information:

1. Scroll to the Ink Menu icon and press **OK**.

Press Enter to confirm selection



Use UP and DOWN keys to select

2. In the Ink submenu, scroll to “Ink cartridge information” and press **OK**.

Press Enter to confirm selection

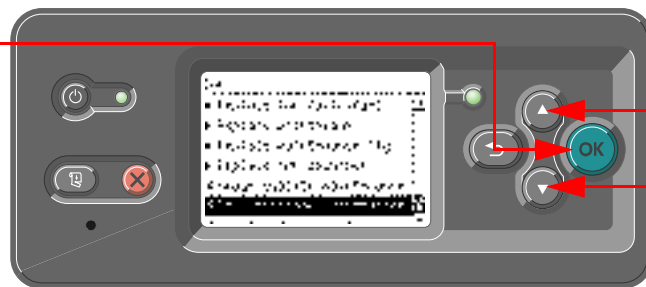

Use UP and DOWN keys to select

3. In the Ink Cartridge Information submenu, scroll to the Ink Cartridge that you want information on and press **OK**.

Press Enter to confirm selection



Use UP and DOWN keys to select

4. The front panel displays information on the selected Ink Cartridge. You can use the UP and DOWN keys to scroll through the information.

```
Y ink cartridge
Color: Yellow
Product name: HP
Product number: C9469A
Serial number: 1187880-38-10
Status: OK
Ink level: 660 ml
Capacity: 775 ml
Expiration date: Mar 26
```

```
Y ink cartridge
Status: OK
Ink level: 660 ml
Capacity: 775 ml
Expiration date: Mar 26, 2009
Warranty status: In warranty
Manufacturer: HP
Expiration date: Mar 26
```

The information supplied is:

- The color of the Ink Cartridge.
- The product name (HP no.789 is recommended).
- The product number of the Ink Cartridge.

- The serial number of the Ink Cartridge.
- The current status of the Ink Cartridge.
- The current ink level of the ink cartridge in milliliters.
- Original capacity of the ink cartridge in milliliters.
- The warranty status of the Ink Cartridge.
- The manufacturer of the Ink Cartridge (HP is recommended).
- The expiration date of the Ink Cartridge.

Obtaining Printhead Information

1. Scroll to the Ink Menu icon and press **OK**.



2. In the Printheads submenu, scroll to "Printhead information" and press **OK**.

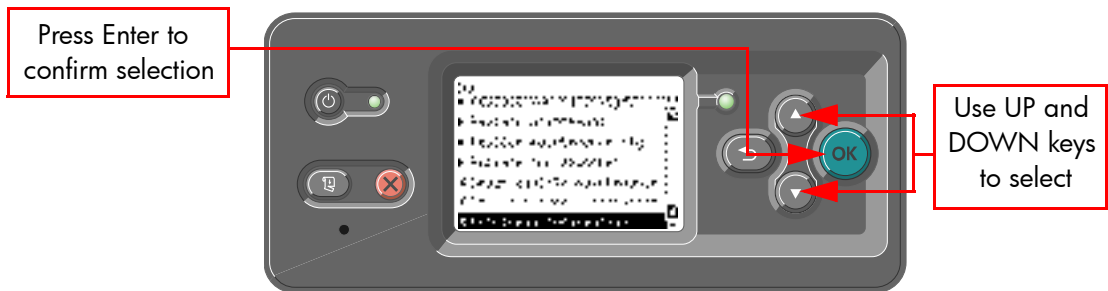

3. In the Printhead Information submenu, scroll to the Printhead that you want information on and press **OK**.

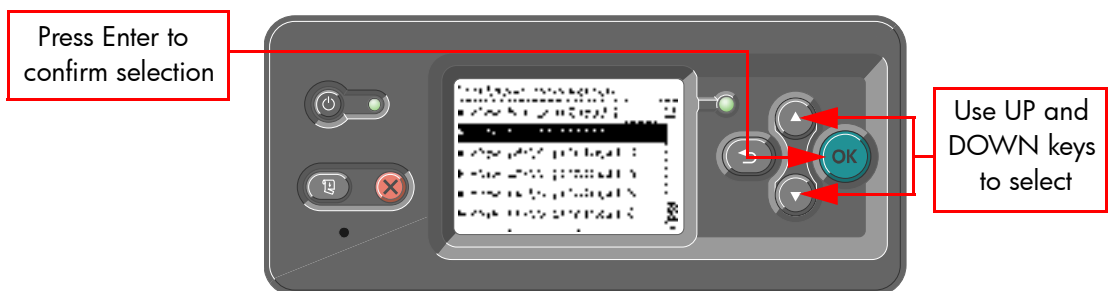

- The front panel displays information on the selected printhead.

M-Y printhead 2
Color: Magenta-Yellow
Product name: HP 91
Product number: C9461A
Serial number: 4-1-1629570-32-2006
Status: OK
Ink fired: 109 ml
Warranty status: In warranty

The information supplied is:

- The make of the printhead (hp no. 789 is recommended).
- The product number of the Printhead.
- The serial number of the Printhead.
- The current status of the printhead.
- How much ink has been fired (consumed) by the printhead. **Note:** It is possible for a printhead to consume more than one Ink Cartridge.
- The current warranty status of the Printhead.
- The current status of the Maintenance Cartridge.

Ink Cartridge Status Messages

Status Bars

The front panel displays four horizontal bars. These bars represent how much ink is remaining in the Ink Cartridges: as ink is used up the bars get shorter in length. To see how much ink is remaining, go to the "Ink Cartridge Information" submenu. See Page 252, "Obtaining Ink Cartridge Information".

Ink Cartridge Status While Printing

OK

The Ink Cartridge is operating correctly and no action is required.

Low

The **Low** message is an early warning sign and it is advisable that new supplies should be obtained of that particular color. The amount of ink remaining in the Ink Cartridge depends on its capacity, but there is approximately 14% of ink available for the user.

Very Low

When the **Very Low** message is displayed, overnight printing should not be attempted. Changing the Ink Cartridge is strongly recommended to prevent the printer from stopping halfway through a print. There is approximately 8% of ink available for the user.

Empty

The printer will stop and will not be able to continue printing until a new Ink Cartridge has been installed. If this occurs halfway through printing an image, you should check the quality of this image, as stopping mid-plot can affect the print. It would be recommended to reprint the image once a new Ink Cartridge has been installed.

Ink Cartridge Status While Replacing

The printer can report the following status messages while the Ink Cartridge is being replaced:

Missing

The Ink Cartridge has not been installed or is installed incorrectly. The Printer will not print until ALL Ink Cartridges have been installed correctly.

Reseat

The Ink Cartridge is having continuity problems. Try removing the Ink Cartridge from the Printer and inserting it in again.

Replace

The Ink Cartridge is faulty and needs to be replaced before the printer can continue printing.

Unknown

The Ink Cartridge installed is not approved **but** the user has confirmed that the cartridge has been refilled or is a non-hp Ink Cartridges. Refer to the User's Guide for further information regarding using refilled or non-hp approved Ink Cartridges.

The main actions for all 4 status messages is as follows:

1. Reseat the Ink Cartridge.
2. If reseating does not resolve the status message, replace the Ink Cartridge.
3. If the Status messages continue to appear, even after replacing the Ink Cartridge, replace the Ink Supply Tubes and Trailing Cable ⇒ Page 380.

Printhead Status Messages While Printing

Detailed below are the printhead status messages that may be displayed while printing.

OK

The printhead is operating correctly and will provide an acceptable level of print quality. To find more information on the printheads, refer to Page 253, Obtaining Printhead Information.

Replace

The Printhead is faulty and needs to be replaced before the printer can continue printing.

If this message continues to appear (for example after installing new Printheads), try the following:

1. Reseat the Printheads and check if the message disappears.
2. Remove the Drop Detector and make sure that there are no obstacles inside which are blocking the sensor.
3. Print the Printhead Health Test plot ⇒ Page 231 to check that the Printhead nozzles are firing correctly.
4. Perform the Service Station service test ⇒ Page 163.
5. Replace ALL the Printheads.

Printhead Status Messages While Replacing

The following are the Printhead status messages that may be displayed while replacing the Printheads.

Reset

In this situation, select the Printhead replacement option through the Front Panel but do NOT remove the Printheads. If this status message continues to appear then remove the Printheads and install them again.

Remove

The Printhead is not a suitable type for use in printing (for example, a Setup Printhead).

Missing

No Printhead has been detected in that Carriage slot. If a Printhead is installed in the Carriage slot when this status message is shown:

1. Reset the Printhead, making sure it is installed correctly.
2. Clean the Carriage and Printhead flex circuits using the Carriage Interconnect Wiper as described in the User's Guide.
3. Replace the Printhead.
4. Perform the Electronic Systems Test ⇒ Page 123.

Printhead Cleaning Cartridge Status Messages While Printing

Detailed below are the Printhead Cleaning Cartridge status messages that may be displayed while printing.

OK

The Printhead Cleaning Cartridge is operating correctly and no action is required.

End of Life

The Printhead Cleaning Cartridge has reached the end of its life and should be replaced.

Printhead Cleaning Cartridge Status Messages While Replacing

The following are the Printhead Cleaning Cartridge status messages that may be displayed while replacing the Printheads.

Reset Cleaner

In this situation, remove the Printhead Cleaning Cartridge and install it again.

Missing

The Printhead Cleaning Cartridge has not been installed or is installed incorrectly. The Printer will not print until the Printhead Cleaning Cartridge has been installed correctly.

Troubleshoot Ink Cartridge and Printhead issues

Most of the problems that you could encounter when working with the ink supplies are solved with guidance from the front panel. A full list of front panel messages are supplied in the User's Guide.

Cannot insert an Ink Cartridge

1. Use the correct procedure to change Ink Cartridges, through the Front Panel. Refer to the User's Guide for further details.
2. Check that there is no obstruction in the Ink Cartridge connector.

3. Check that the Ink Cartridge is the correct color. A connector of an Ink Cartridge will refuse to connect to a cartridge of an incorrect color
4. Ensure that the Ink Cartridge is the correct orientated (compare it with the others).

Cannot insert a Printhead

1. Use the correct procedure to change printheads, through the Front Panel. Refer to the User's Guide for further details.
2. Check there is no obstruction in the Printhead slot.
3. Check the printhead is correctly orientated.
4. Check that the Printhead latch and Printhead cover is closed and secured.

The Front Panel recommends replacing or reseating an Ink Cartridge

1. Disconnect the Ink Cartridge
2. Reconnect the Ink Cartridge and check the Front Panel message.
3. If the problem persists, insert a new Ink Cartridge.
4. If the problem continues, escalate the issue to division level.

The Front Panel recommends replacing or reseating a Printhead

If there is an error with one of the Printheads, the printer will display an error message on the Front Panel. However more information about the specific error can be found by looking at the error code in the 'Current Information' section of the 'Print Service Information' page. The printhead error code can be found in the Service Information Print. Go to Setup Menu>Information menu>Internal Prints>Print Service Information>Current Information.

The actual error code is a decimal number that must first be converted to a binary number before it can be used.

Current configuration | Current information | Usage information | Event logs | Calibration status | Connectivity configuration | All pages

Current Substrate, Printhead and Ink Information (1 of 2)

Date: Nov 18, 2009 2:31:48 PM Product: HP DesignJet L26500 42in Printer Serial Number: MY94M09009
 Firmware: GG-CAL_1.0.0.7 Product number: CH955A Service ID: 19146
 Printer status: Ready - Temp. OK to open window

Current Printer Configuration

Language: English Memory: 256 MB
 Disk capacity: 180 GB
 Current Temperature: 20.0°C ±2°C Current Humidity: 58% ±15%

Substrate Loaded Information

Substrate Path: Roll Substrate Loaded Status: OK
 Substrate Type: Paper-Aqueous
 Substrate Width: 914 mm / 36.0 inches

Current Printhead Kit Info (I)

	Warranty status	Status	Error ID Code	Product Number
1 - Cyan-Light cyan	In warranty	OK	0	C9481A
2 - Cyan-Light cyan	In warranty	OK	0	C9481A
3 - Yellow-Black	Out of warranty	OK	0	C9482A
4 - Yellow-Black	Out of warranty	OK	0	C9482A
5 - Magenta-Light magenta	In warranty	OK	0	C9483A
6 - Magenta-Light magenta	In warranty	OK	0	C9483A

Current Printhead Kit Info (II)

	Product Name	Serial Number	Warranty Date
1 - Cyan-Light cyan	HP 789	4-1-3480030-2-2009	20110114
2 - Cyan-Light cyan	HP 789	4-1-3480133-2-2009	20110114
3 - Yellow-Black	HP 789	4-1-3479788-2-2009	20110114
4 - Yellow-Black	HP 789	4-1-3479797-2-2009	20110114
5 - Magenta-Light magenta	HP 789	4-1-3717974-9-2009	20110304
6 - Magenta-Light magenta	HP 789	4-1-3480458-2-2009	20110114

Current Printhead Kit Info (III)

	Used non-HP ink	Used expired ink	Ink Used	% warranty used (ml)
1 - Cyan-Light cyan	false	false	830 ml	85%
2 - Cyan-Light cyan	false	false	830 ml	85%
3 - Yellow-Black	false	false	1280 ml	125%
4 - Yellow-Black	false	false	1240 ml	125%
5 - Magenta-Light magenta	false	false	800 ml	80%
6 - Magenta-Light magenta	false	false	820 ml	85%

Current Printhead Kit Info (IV)

	Usage Time	Scan Axis Shutdown
1 - Cyan-Light cyan	1 h	0
2 - Cyan-Light cyan	1 h	0
3 - Yellow-Black	1 h	0
4 - Yellow-Black	1 h	0
5 - Magenta-Light magenta	18 h	0
6 - Magenta-Light magenta	18 h	0

The following table explains the meaning of the different bits (0 or 1). When the value of the error code is displayed as 0, it means that the Printhead is working correctly.

Error code	Meaning	Corrective action
0x0000	WORKING	
0x00001	FAILS LOGICAL V	Clean the electrical connections between the Printhead and the Carriage. Refer to the customer's Maintenance Guide.
0x00002	FAILS CONTINUITY	
0x00004	SHUTDOWN	Refer to the 'Temperature too high procedure' below
0x00008	FAILS VPP	Clean the electrical connections between the Printhead and the Carriage. Refer to the customer's Maintenance Guide.
0x00010	TEMP EXTREMELY HIGH	Refer to the 'Temperature too high procedure' below
0x00020	TEMP EXTREMELY LOW	Clean the electrical connections between the Printhead and the Carriage. Refer to the customer's Maintenance Guide.

Error code	Meaning	Corrective action
0x00040	TEMP TOO HIGH	Refer to the 'Temperature too high procedure' below
0x00080	TEMP TOO LOW	
0x00100	BAD ACUMEN INFO	Clean the electrical connections between the Printhead and the Carriage. Refer to the customer's Maintenance Guide.
0x00200	NO PEN	
0x00400	BAD ACUMEN ACCESS	
0x00800	WRONG MODEL	Replace the Printhead, as the type of Printhead inserted it not supported by the Printer
0x01000	MISMATCH	
0x02000	CSDATA NOT RESPONDING	Clean the electrical connections between the Printhead and the Carriage. Refer to the customer's Maintenance Guide.
0x04000	CSDATA TRANSMIT ERROR	
0x08000	FAILS ENERGY CALIBRATION	
0x40000	END OF LIFE	Replace the 'Out of Warranty' Printhead
0x80000	EXPIRED	

Printhead Temperature too high procedure

1. Perform a Printhead recovery- Go to the ink menu in the Front Panel and select Image Quality Maintenance>Clean Printheads.
2. Reprint the job with lower drying temperatures.
3. Reprint the job with higher number of passes.
4. If the problem persists, replace the Printhead.

A Printhead has damaged the substrate

When a Printhead touches the substrate, the most probable cause is excessive drying temperature. Reduce the heating and curing temperature.

Incorrect error messages displayed about the Cleaning Cartridge roller

If the customer touches the roller of the Printhead cleaning Cartridge, this can cause the printer to lose track of how much of the wiping material was left on the roller and cause the printer to cancel jobs and display erroneous error messages. Explain to the customer that the roller of the Printhead Cleaning Cartridge must never be touched, and only handle the cartridge if it requires replacement.

Warranty Information for Ink Supplies

Ink Cartridge

The warranty for the Ink Cartridges will end when one of the following occurs:

- 24 months from the date of manufacture.
- or
- When the advertised deliverable ink has been reached
 - Host Ink Cartridge: (775ml/26.2 floz)
- or

- When the user confirms that they have used non-hp ink in empty over-ride mode.

Which ever occurs first.

The actual end of warranty date is printed on the supply label and the supply label. It is also recorded in the smart chip.



Printheads

The warranty for the Printheads will end when one of the following occurs:

- 24 months from the date of manufacture
- or
- When 1000 cc of ink has been consumed by the Printhead, adding both colors.
- or
- When the user confirms that they have used non-hp ink in empty over-ride mode.

Which ever occurs first.

The actual end of warranty date is printed on the printhead box. It is also recorded in the smart chip.

7 Parts and Diagrams

- Printer Support.....262
- Front Covers264
- Top & Rear Covers266
- Electronics Module268
- Right Cover270
- Left Cover.....272
- Right Hand Assemblies274
- Left Hand Assemblies.....276
- Carriage Assembly278
- Dryer Assembly.....280
- Curing Assemblies.....282
- Curing Fans Assembly284
- Scan-Axis Assemblies286
- Drive Roller and Media-Axis Motor288
- Media Path Assemblies290
- Center Guide and Pinchwheel Assembly.....292
- Media Entry Assemblies294
- Take-Up Reel Assembly296
- Miscellaneous Parts298

Printer Support

Reference on Figure	HP Part Number	Part Description	Size	Page ^a
1	Q6651-60257	Leg Cover	All	N/A
2	CH955-67072	Foot Assembly	All	N/A
3	Q6651-60259	Foot Brace Assembly	42-inch	N/A
	Q6651-60262		60-inch	N/A
4	Q6651-60255	Legs Assembly	All	N/A
5	CH955-67073	Cross-Brace Assembly	42-inch	N/A
	CH956-67026		60-inch	N/A
6	Q6651-60264	Stand Supports (left and Right)	All	N/A
-	Q6651-60256	Hardware Kit (Includes screws for Legs Assembly)	All	N/A

a. Refers to the page in the Removal and Installation Chapter (if applicable)

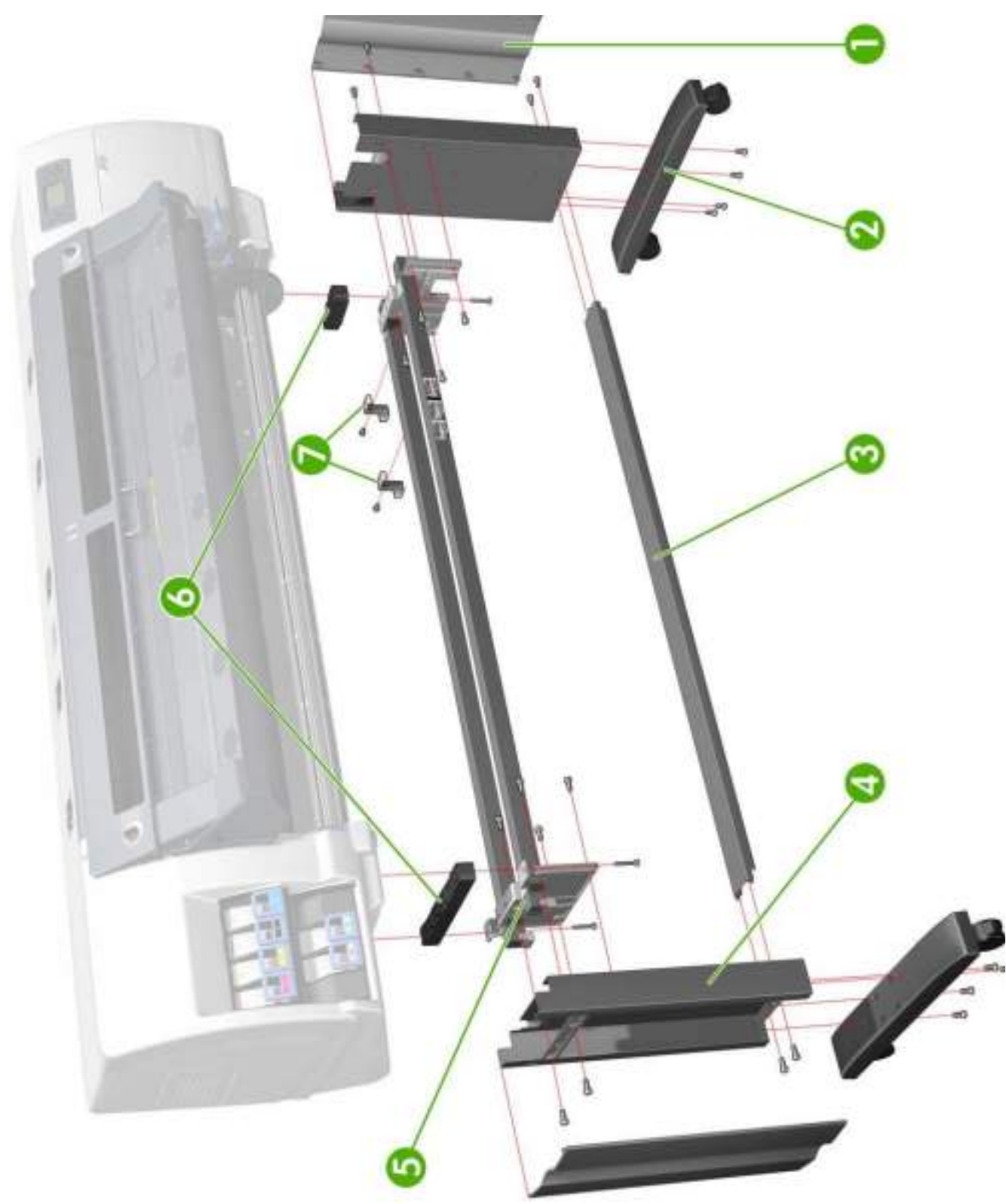

Figure 1: Printer Support

Front Covers

Reference on Figure	HP Part Number	Part Description	Size	Page ^a
1	CH956-67035	Window Assembly	42-inch	311
	CH956-67010		60-inch	
2	CH955-67100	Window Mylar	42-inch	
	CH956-67037		60-inch	
3	CH955-67055	Transparent Window	42-inch	
	CH956-67016		60-inch	
4	CH955-67047	Window Locks	All	
5	CH955-67086	Right Curing Cover	All	330
6	CH955-67087	Left Curing Cover	All	328
7	CH955-67046	Window Lock Sensor	All	345
8	CH955-67067	Window Hinge Breaks	All	316
9	CH955-67093	Window Lock Sensor Cable	42-inch	
	CH956-67034		60-inch	

a. Refers to the page in the Removal and Installation Chapter (if applicable)

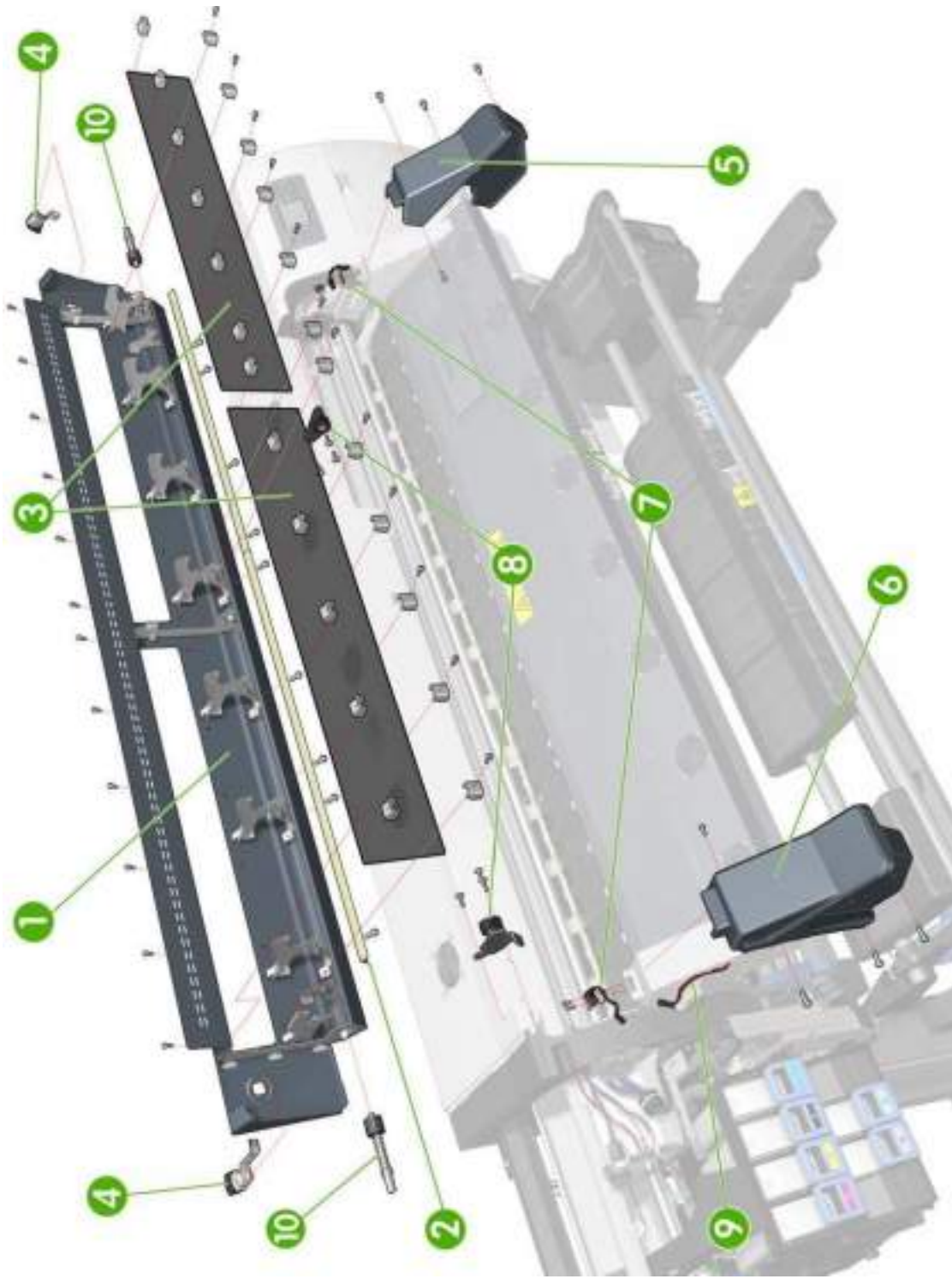

Figure 2: Front Covers

Top & Rear Covers

Reference on Figure	HP Part Number	Part Description	Size	Page ^a
1	CH955-67041	Rear Cover	42-inch	332
	CH956-67008		60-inch	
2	CH955-67081	Left Connector Cover	42-inch	343
	CH956-67007	Electronics Module Extension	60-inch	344
3	Q6651-60332	Right Connector Cover	All	341
4	Q1271-60369	Window Position Sensor	All	
5	CH955-67048	Top Cover Fan	All	349
6	CH955-67038	Top Cover	42-inch	334
	CH956-67003		60-inch	
7	CH955-67050	Top Cover Fan Diffusors	All	
8	CH955-67051	Top Cover Fan Grill	All	
9	CH956-67049	Top Cover Fans Cable	42-inch	
	CH956-67015		60-inch	
10	CH955-67088	Rear Dryer Fan	All	351
11	CH955-67092	Dryer Fans Cable	42-inch	
	CH956-67033		60inch	

a. Refers to the page in the Removal and Installation Chapter (if applicable)

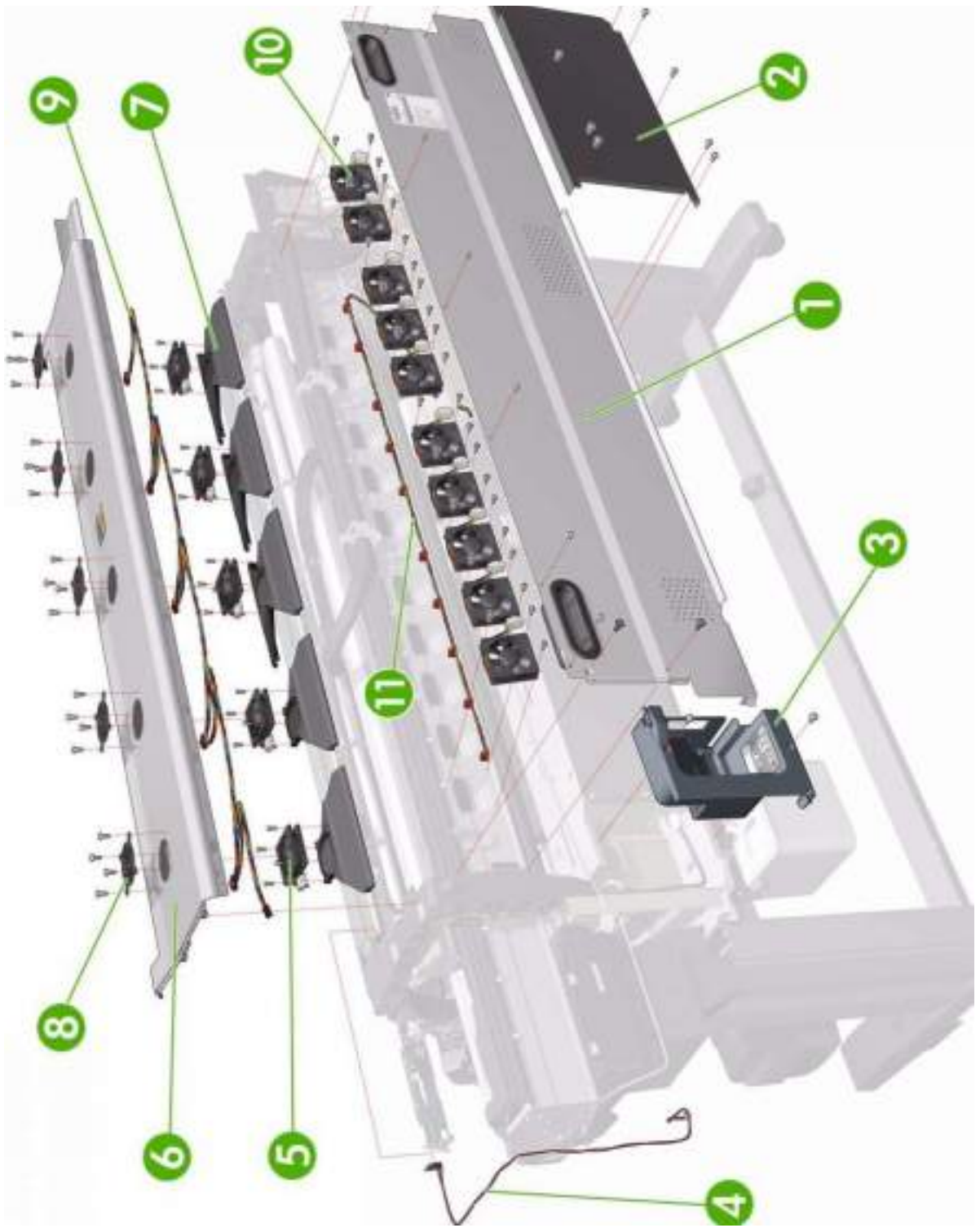

Figure 3: Top & Rear Covers

Electronics Module

Reference on Figure	HP Part Number	Part Description	Size	Page ^a
1	CH955-67022	Electronics Module Cables Kit	All	N/A
2	CH955-67010	OMAS PCA	All	437
3	CH955-67021	Sausalito PCI PCA	All	444
4	Q6651-60282	Main PCA Formatter (Includes Processor, Heatsink & Fan).	All	450
5	CH955-67009	Interconnect PCA	All	435
6	CH955-67023	Empty Electronics Module Assembly	All	N/A
7	CH955-67020	Electronics Module Metal Parts Kit	All	N/A
8	CH955-67006	Power Supply Unit (PSU)	All	456
9	CH955-67030	PrintMech PCA	All	482
10	Q1273-60249	Memory Module SDRAM DIMM 32MX64 256M 184-DIM	All	448
11	CH955-67031	Hard Disk Drive (Includes Holder and screws)	All	452
12	Q1271-60160	CPU Fan	All	446
13	CH955-67052	Heaters Control Assembly: Petisa (includes cooling fan)	All	465
14	CH955-67078	Heater Control Assembly Cooling Fan	All	473
15	CH955-67079	2 Residual Current Circuit Breakers (RCCB)/GFIs	All	476
16	CH955-67080	Dryer AC Input	All	478
17	CH955-67074	SATA Bridge PCA	All	454

a. Refers to the page in the Removal and Installation Chapter (if applicable)

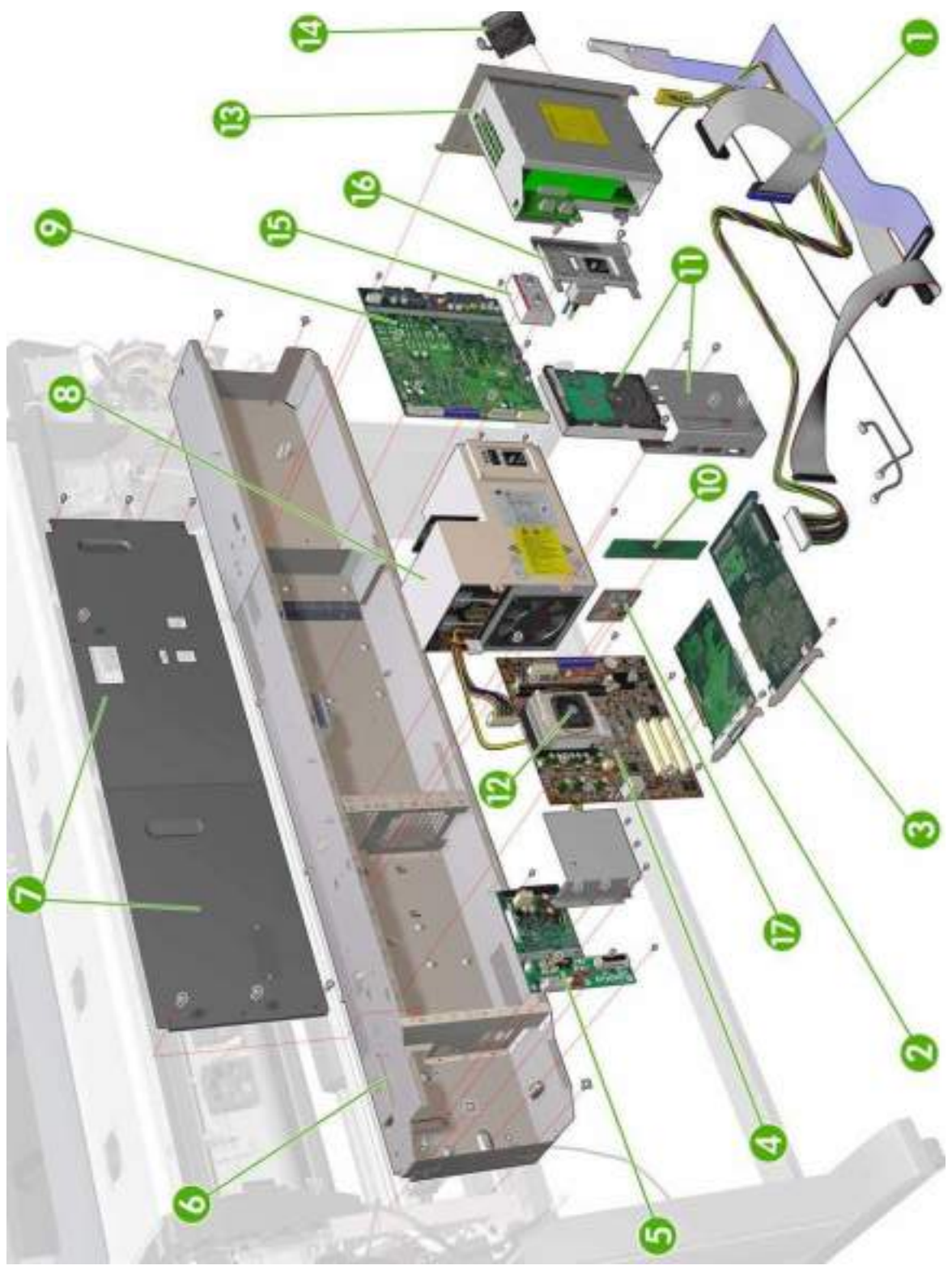

Figure 4: Electronics Module

Right Cover

Reference on Figure	HP Part Number	Part Description	Size	Page ^a
1	CH955-67019	Right Cover (without Right Door)	All	319
2	CH955-67029	Printhead Maintenance Cartridge Door	All	553
3	CH955-67025	Right Trim	All	322
4	Q1273-60240	Front Panel ^b	All	353
5	CH955-67027	Front Panel Bezel	All	353

a. Refers to the page in the Removal and Installation Chapter (if applicable)

b. Including cable and ferrite cores

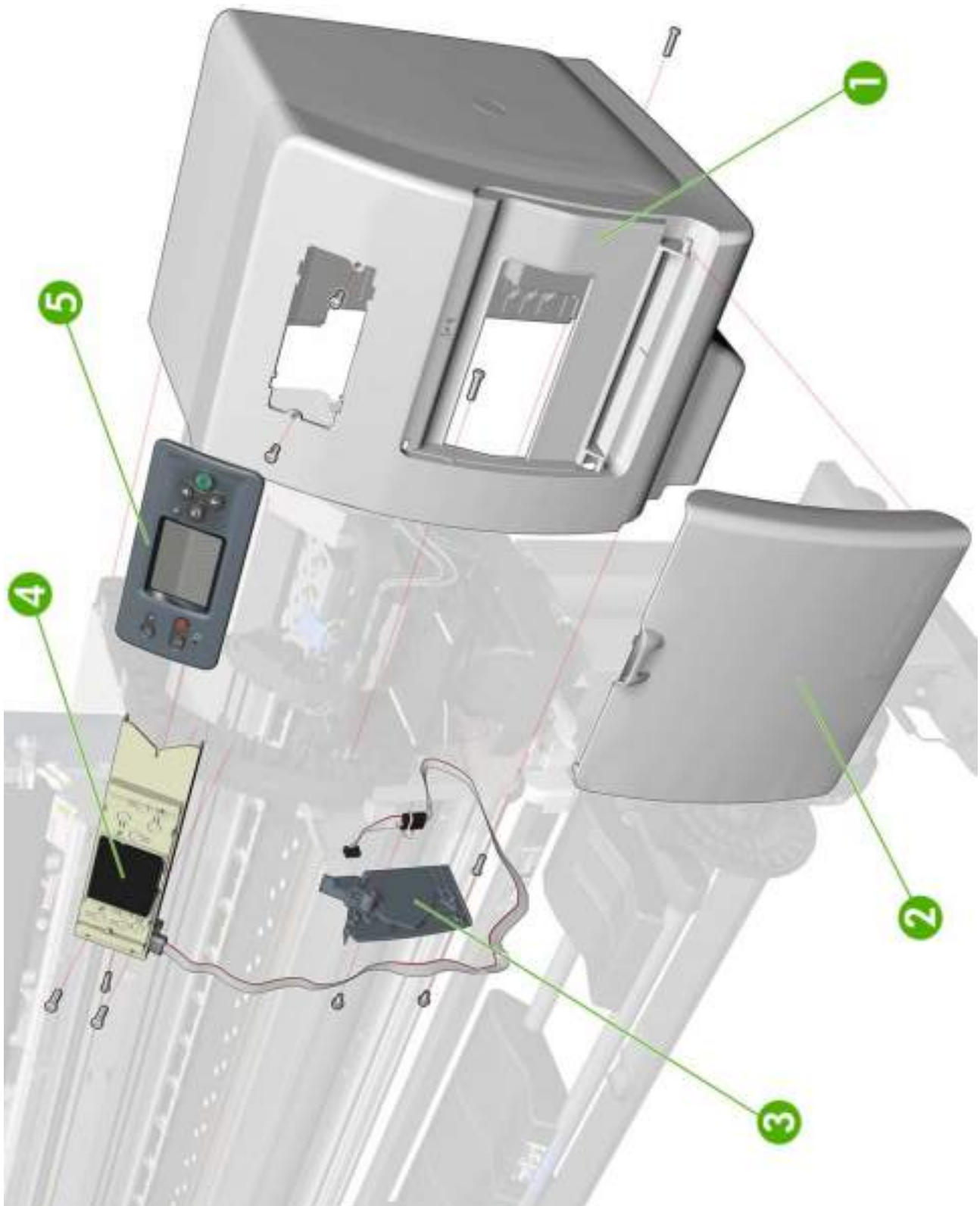

Figure 5: Right Hand Cover

Left Cover

Reference on Figure	HP Part Number	Part Description	Size	Page ^a
1	CH955-67018	Left Cover	All	325
2	CH955-67026	Left Trim	All	327

a. Refers to the page in the Removal and Installation Chapter (if applicable)

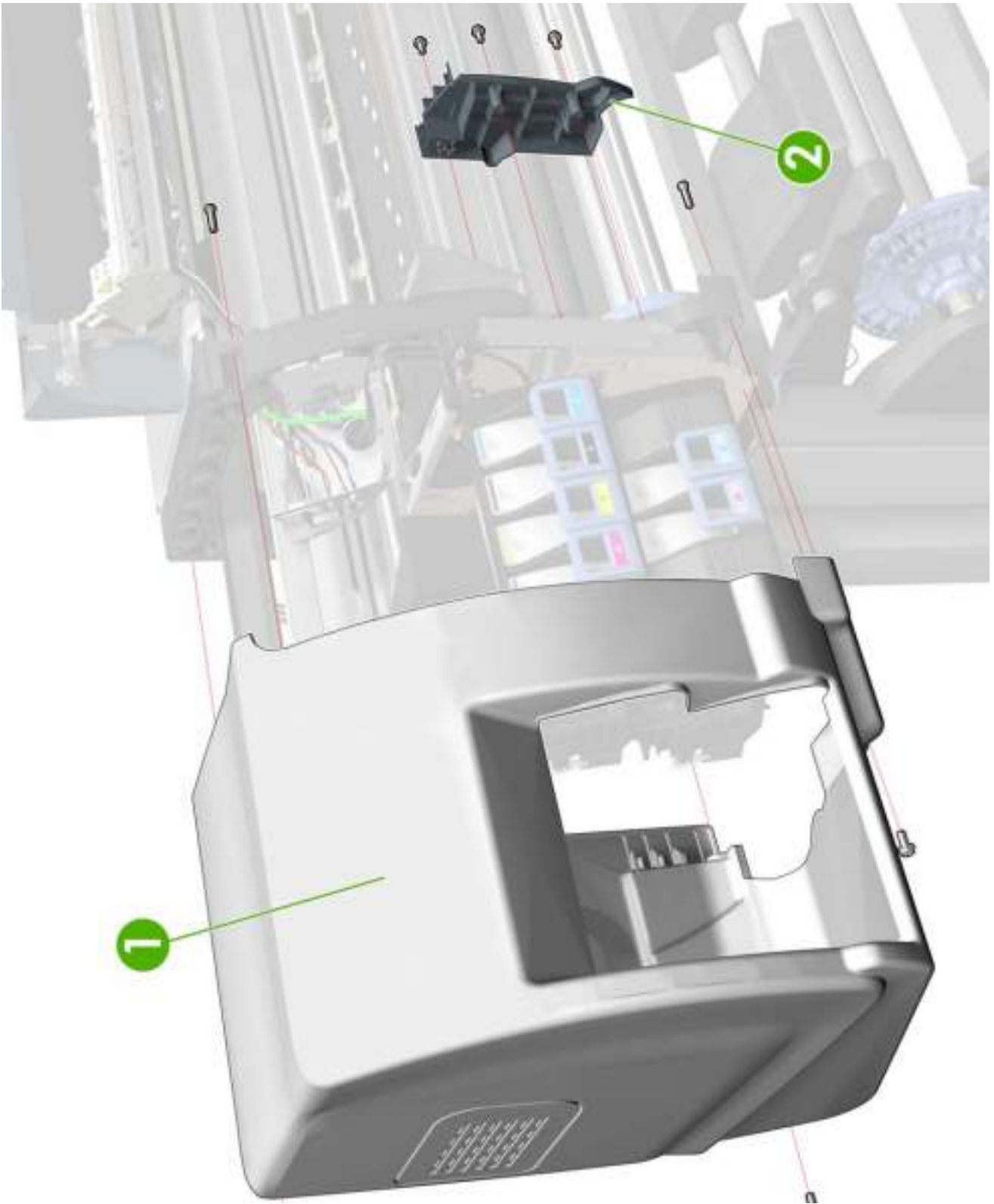

Figure 6: Left Hand Cover

Right Hand Assemblies

Reference on Figure	HP Part Number	Part Description	Size	Page ^a
1	Q1273-60086	Right Scan-Axis Bracket	All	-
2	CH955-67012	Service Station Assembly ^b	All	364
3	Q6651-60266	Primer Valves and Primer Tubes Assembly	All	357
4	CH955-67034	Aerosol Filter & Fan assembly	All	373
5	Q1273-60273	Service Station Cable (Includes Printhead Cleaning Cartridge Door Sensor)	All	364
6	CH995-67095	Vacuum Fan Assembly	All	370
7	CH955-67004	Drop Detector	All	377
8	Q6651-60265	Primer Assembly	All	355
9	CH955-67053	Web Wiper Motor Assembly	All	368
10		Printhead Cleaner Container	All	-
11	CH955-67045	Spittoon Assembly (includes funnel, tube and end section)	All	376
12	CH955-67064	Rewinder Motor and Gears	All	361

a. Refers to the page in the Removal and Installation Chapter (if applicable)

b. Includes Service Station Cable

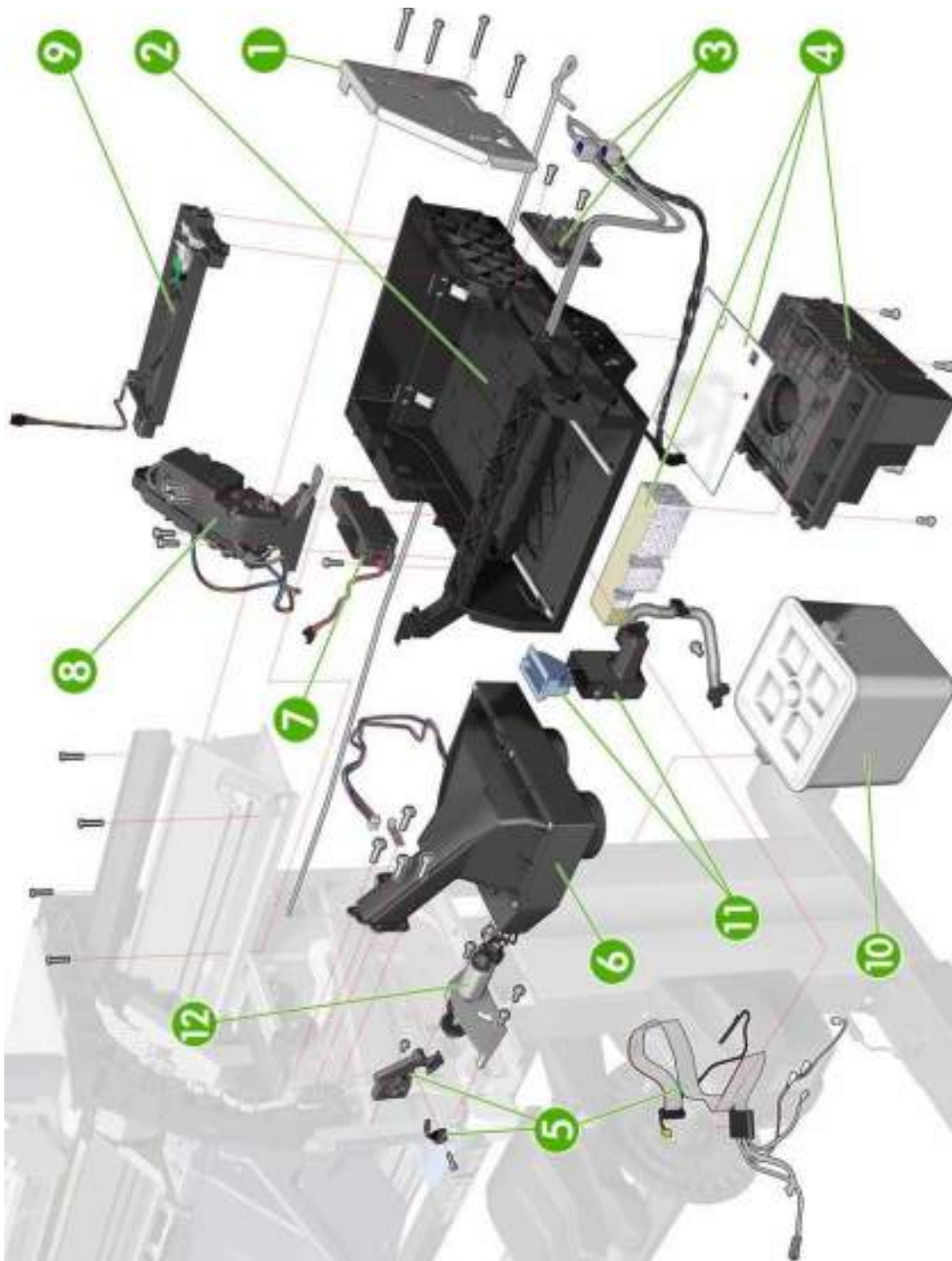

Figure 7: Right Hand Assemblies

Left Hand Assemblies

Reference on Figure	HP Part Number	Part Description	Size	Page ^a
1	CH955-67028	Cartridge Trays	All	548
2	CH955-67014	Lower Ink Supply Station (without APS Assembly but including Cartridge Tray)	All	388
3	CH955-67013	Upper Ink Supply Station (without APS Assembly but including Cartridge Tray)	All	388
4	CH955-67024	Left Scan-Axis Bracket	All	N/A
5	Q1273-60245	ISS to Cartridge Cable	All	N/A
6	Q6651-60300	APS Assembly ^b	42-inch	395
	Q6652-60117		60-inch	
7	Q6651-60272	Color Sensor Actuator	ALL	492
8	CH955-67054	ISS PCAs	All	
9	CH955-67084	Shutter Bump (actuator)	All	
10	CH955-67091	Cable Plate and Cover	All	
11	CH955-67096	Paper Jam Sensor (Includes Carriage Reflector & cable)	All	
12	-	Paper Jam sensor cable	All	
13	CH956-67094	Cable Plate Bundle (cables)	42-inch	
	CH956-67035	Cable Plate Bundle (cables)	60 - inch	

a. Refers to the page in the Removal and Installation Chapter (if applicable)

b. Including Pump, Holder, and Relief Valve



Figure 8: Left Hand Assemblies

Carriage Assembly

Reference on Figure	HP Part Number	Part Description	Size	Page ^a
1	Q6651-60297	Line Sensor Assembly ^b	All	486
2	CH955-67005	Encoder Sensor (Includes Encoder Strip)	42-inch	399
	CH956-67005		60-inch	
3	CH955-67017	Carriage Assembly ^c	All	408
4	CH955-67007	Cutter Assembly	All	386
5	Q6651-60341	Carriage Stopper (includes Carriage Stopper Screw and Media-Axis Motor Bracket)	All	408
6	CH995-67101	Color Sensor (SOL)	All	488
7	Q6651-60335	Setup Printhead Kit	All	N/A
8	CH995-67099	Carriage Flex Cables	All	405
9	Q6651-60338	Carriage PCA	All	402
10	CH955-67083	SOL Shutter Protector	All	
11	CH955-67096	Carriage Reflector (Includes Paper Jam Sensor)	All	413

a. Refers to the page in the Removal and Installation Chapter (if applicable)

b. Includes Line Sensor Holder and Cable

c. Does not include, Carriage PCA, Encoder Sensor, and Color Sensor

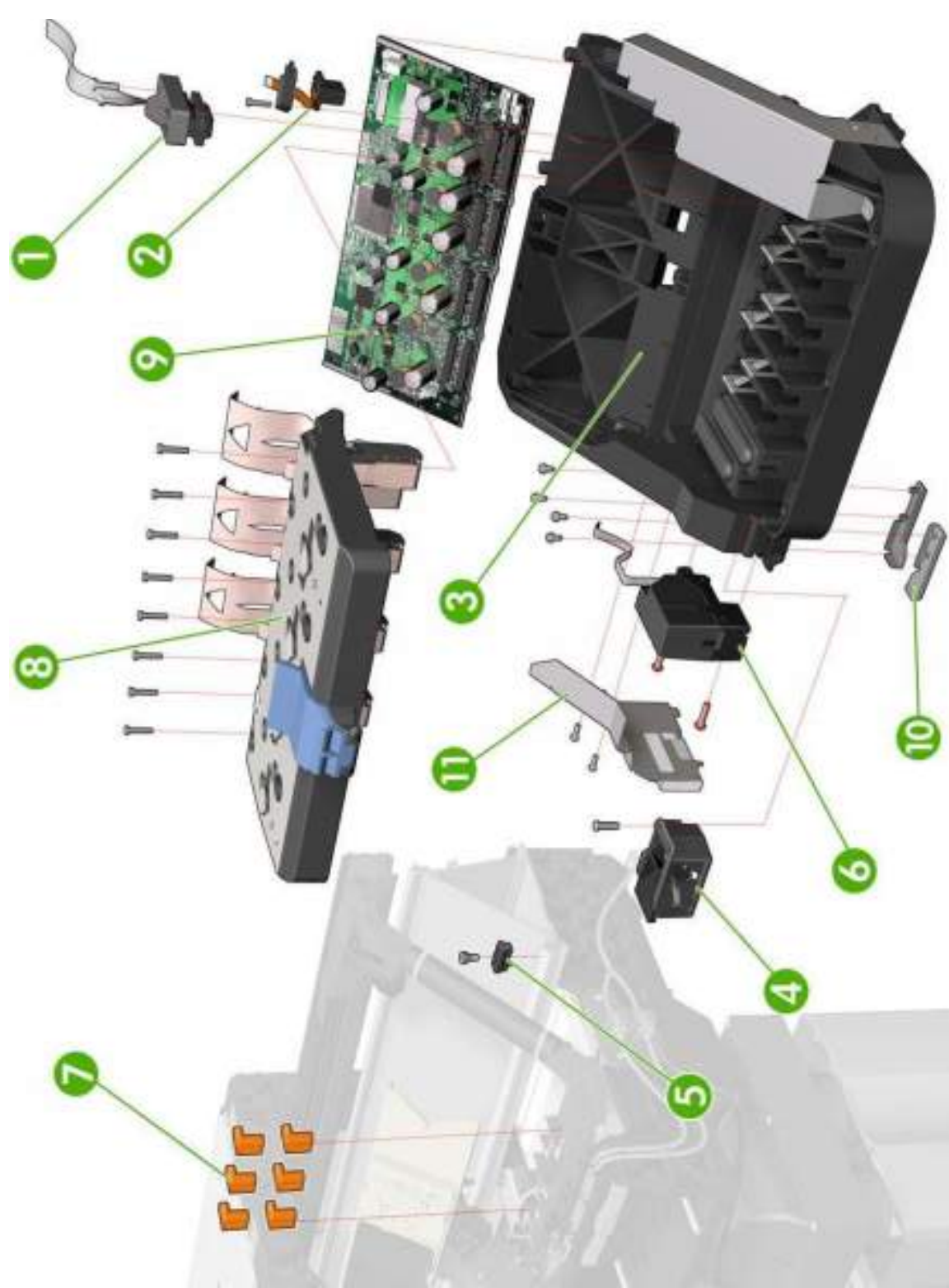

Figure 9: Carriage Assembly

Dryer Assembly

Reference on Figure	HP Part Number	Part Description	Size	Page
1	CH955-67105	Dryer Module (includes thermal switch, resistors)	42 - inch	498
	CH956-67038		60 - inch	
	CQ162-67002	Dryer Module (includes thermal switch, resistors) (Japan)		
2	CH956-67030	Dryer Grill	60-inch	494
3	CH955-67057	Dryer IR Temperature Sensor	42-inch	496
	CH956-67018		60-inch	

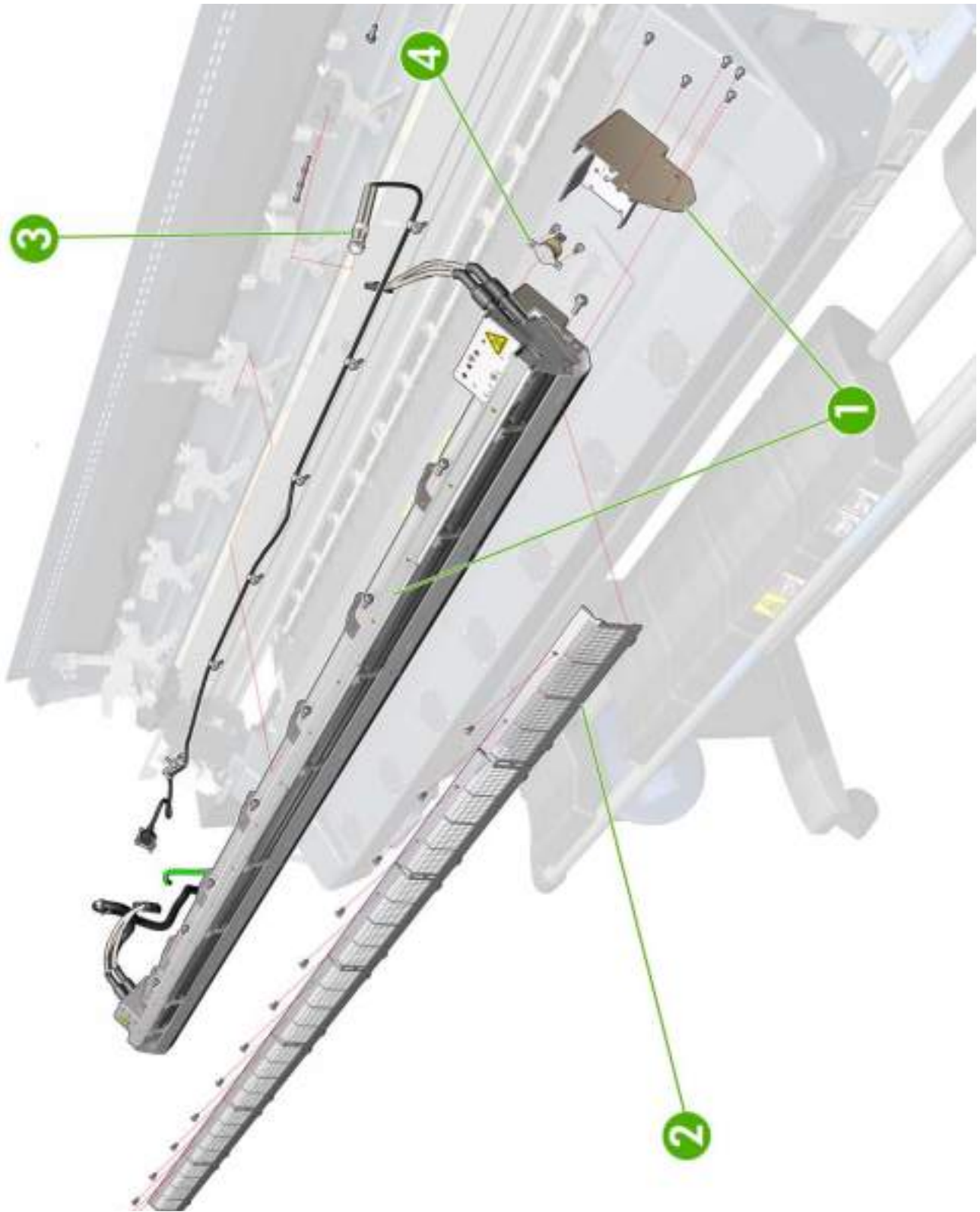

Figure 10: Dryer Assembly

Curing Assemblies

Reference on Figure	HP Part Number	Part Description	Size	Page
1	CH955-67058	Curing Module base (without Fans)	42-inch	525
	CH956-67019		60-inch	
2	CH955-67089	Curing Holder Bracket	All	535
3	CH955-67090	Curing Trims (Left and Right)	All	525
4	CH955-67104	Curing Thermal Switch	All	515
5	CH955-67098	IR Curing Sensor Fan	42-inch	510
	CH956-67036		60-inch	
6	CH955-67060	IR Curing Sensor	42-inch	510
	CH956-67021		60-inch	
7	CH955-67059	Curing Resistors	42-inch	515
	CH956-67020		60-inch	
	CQ162-67001	Curing Resistors (Japan)	60-inch	
8	CH955-67075	Curing Grill	42-inch	515
	CH956-67031		60-inch	
9		Curing Resistor Holders	All	515

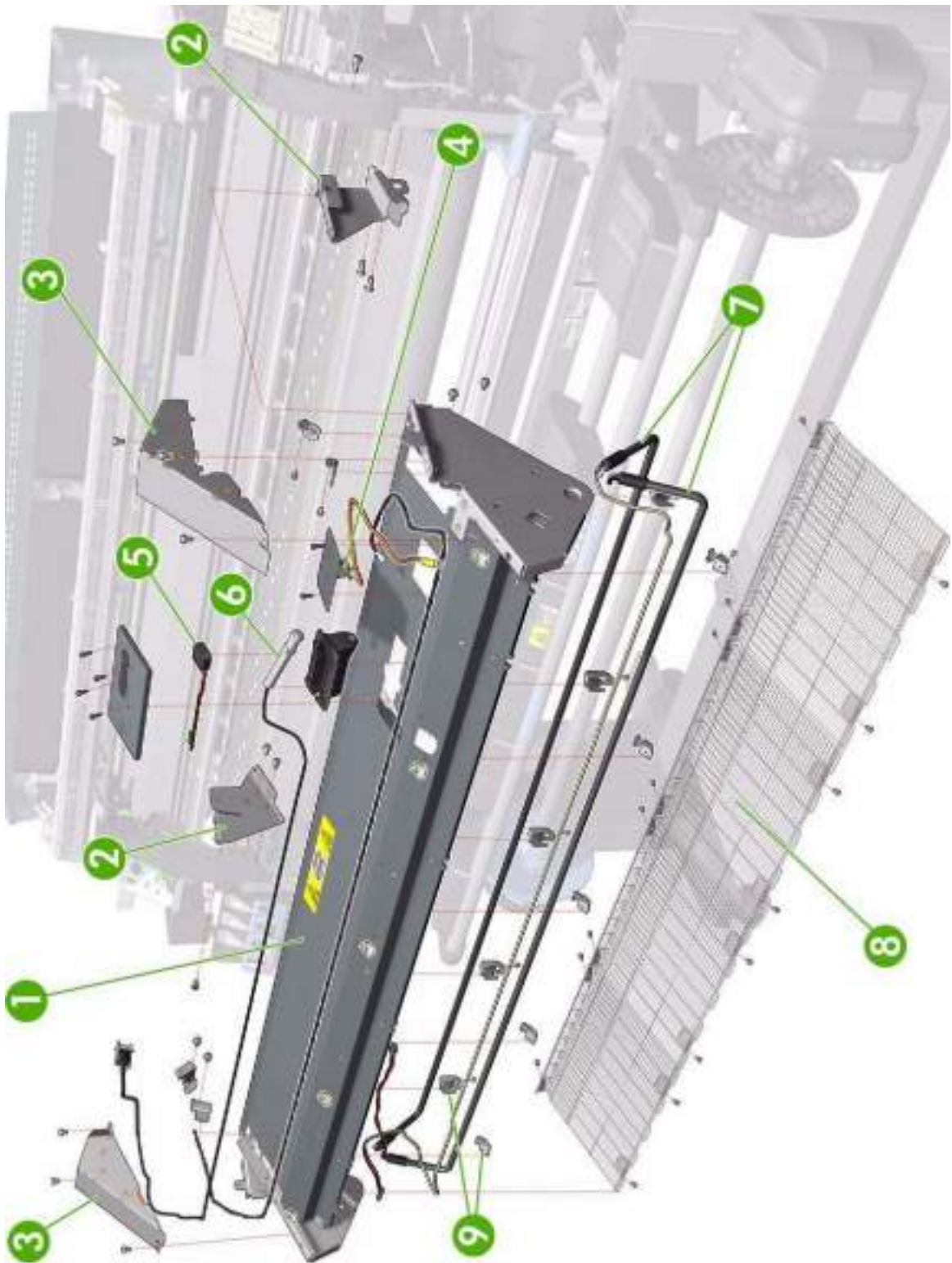

Figure 11: Curing Assemblies

Curing Fans Assembly

Reference on Figure	HP Part Number	Part Description	Size	Page
1	CH955-67061	Curing Fans Cover (without fans)	42-inch	525
	CH956-67022		60-inch	
2	CH955-67062	Curing Fan	All	525
3	CH955-67063	Curing Fan cable	42-inch	
	CH956-67023		60-inch	

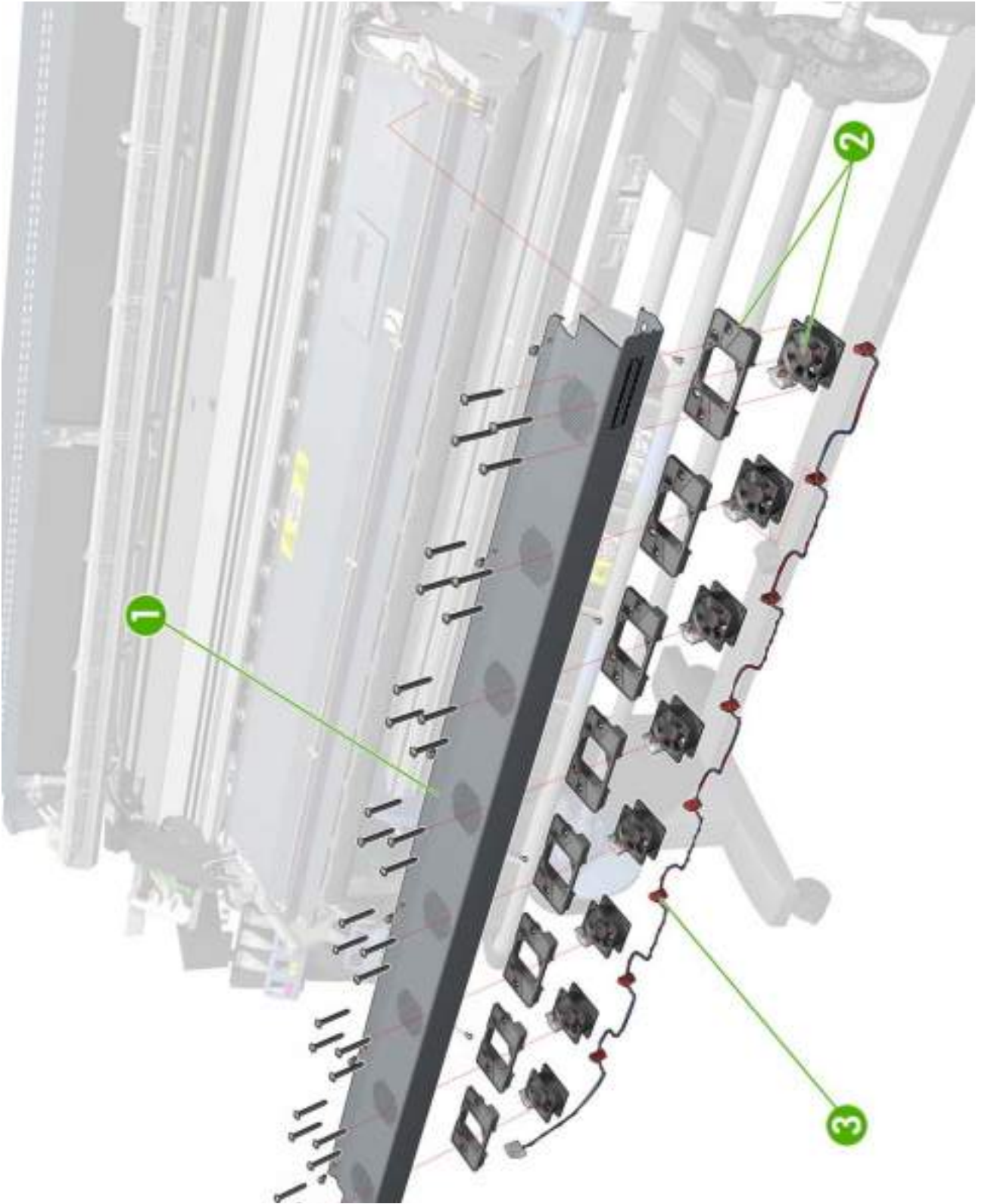

Figure 12: Curing Fans Assembly

Scan-Axis Assemblies

Reference on Figure	HP Part Number	Part Description	Size	Page ^a
1	CH955-67005	Encoder Strip and Encoder Sensor Kit	42-inch	399
	CH956-67005		60-inch	
2	Q1273-60071	Scan-Axis Motor	42-inch	419
	Q6652-60128		60-inch	
3	CH955-67015	Ink Supply Tubes and Trailing Cable	42-inch	380
	CH956-67002		60-inch	
4	CH955-67002	Ink Supply Tubes Clips	All	380
5	Q6651-60336	Rear Tube Shelf and Brackets	42-inch	380
	Q6652-60126		60-inch	
6	Q1273-60228	Belt and Tensioner Assembly	42-inch	408
	Q6652-60118		60-inch	
-	CH955-67076	Broken Bag Fixing Tools		155

a. Refers to the page in the Removal and Installation Chapter (if applicable)

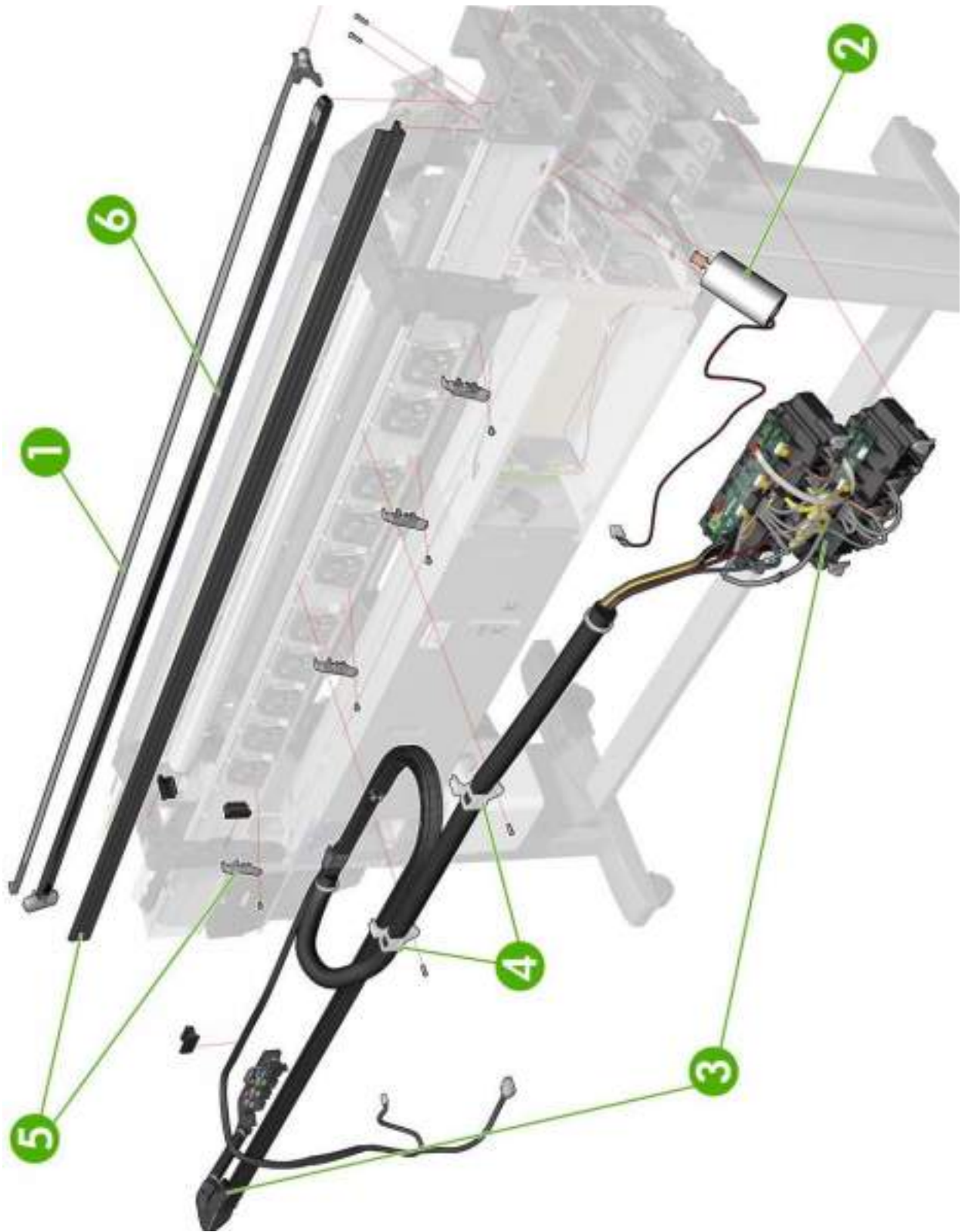

Figure 13: Scan-Axis Assemblies

Drive Roller and Media-Axis Motor

Reference on Figure	HP Part Number	Part Description	Size	Page ^a
1	Q6651-60320	Drive Roller Encoder Kit	42-inch	419
	Q6652-60123		60-inch	
2	Q1273-60242	Drive Roller Gears and Drive Roller Brake Kit	All	573
3	Q1273-60039	Drive Roller	42-inch	573
	Q6652-60109		60-inch	
4	Q1273-60247	Media Advance Drive ^b	42-inch	422
	Q6652-60108		60-inch	

a. Refers to the page in the Removal and Installation Chapter (if applicable)

b. includes Media Advance Drive Mount and Cable

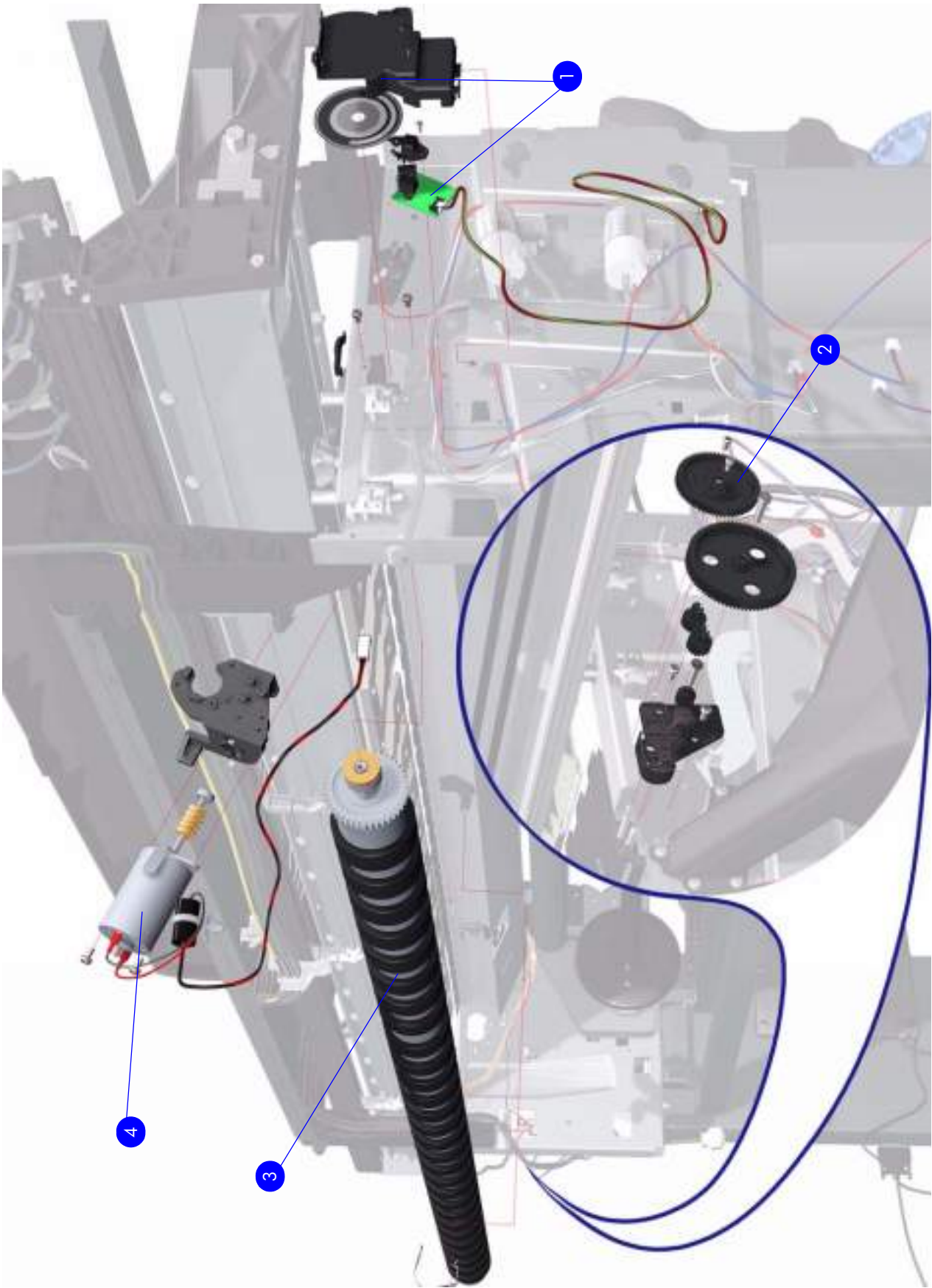

Figure 14: Drive Roller and Media-Axis Motor

Media Path Assemblies

Reference on Figure	HP Part Number	Part Description	Size	Page ^a
1	CH955-67011	Center Platen ^b	42-inch	538
	CH956-67001		60-inch	
2	CH955-67039	Output Platen	42-inch	533
	CH956-67004		60-inch	
3	CH955-67065	Output Roller Support (& Pins)	All	552
4	Q1273-60103	Input Roller Lever	All	550
5	Q1273-60058	Input Roller	42-inch	550
	Q6652-60114		60-inch	
6	Q6651-60270	OMAS Module	All	424
7	Q6651-60269	OMAS Cable	All	439
8	CH955-67066	TOMAS Assembly	All	431

a. Refers to the page in the Removal and Installation Chapter (if applicable)

b. Includes the Attachment Screw Retainer



Figure 15: Media Path Assemblies

Center Guide and Pinchwheel Assembly

Reference on Figure	HP Part Number	Part Description	Size	Page ^a
1	Q6651-60067	Complete Pinchwheel Assembly ^b	42-inch	565
	Q6651-60153		60-inch	
2	Q6651-60345	Center Guide	42-inch	571
	Q6652-60130		60-inch	
3	CH955-67097	Media Sensor	All	555
4	Q6651-60319	Media Lever Assembly	All	560
5	Q1273-60082	Media Lever Sensor	All	563
6	Q6651-60066	Pinchwheel Kit	All	565

a. Refers to the page in the Removal and Installation Chapter (if applicable)

b. Includes Media Sensor

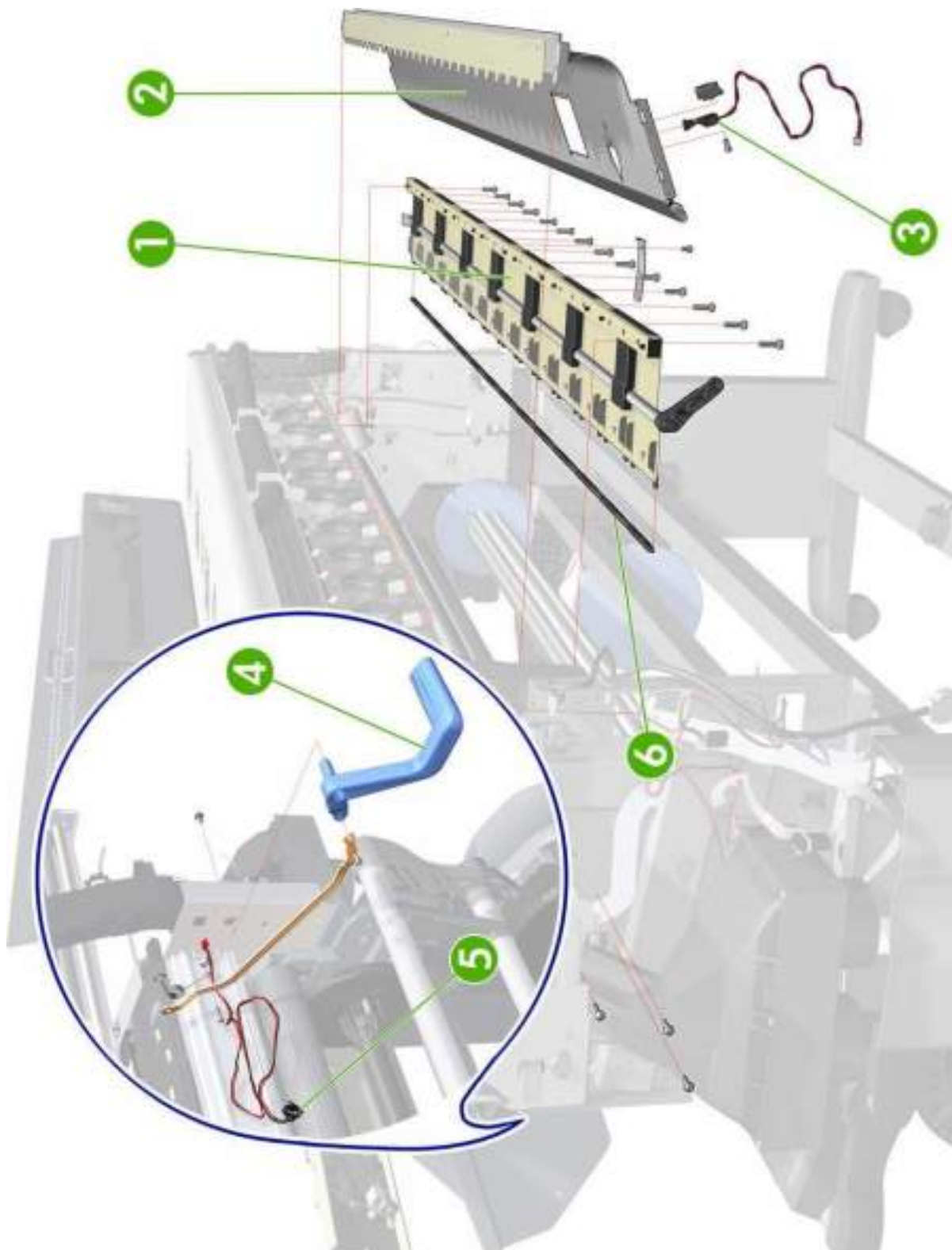

Figure 16: Center Guide and Pinchwheel Assembly

Media Entry Assemblies

Reference on Figure	HP Part Number	Part Description	Size	Page ^a
1	CH955-67040	Right Rollfeed Module Assembly	All	579
2	CH955-67036	Spindle	42-inch	N/A
	CH956-67011		60-inch	
3	CH955-67085	Right Rollfeed Module Cover	All	579
4	CH955-67037	Spindle Hub	All	N/A
5	CH955-67008	Left Rollfeed Module Assembly	All	580
6	CH955-67107	Cal Spindle Left Endcap	All	

a. Refers to the page in the Removal and Installation Chapter (if applicable)



Figure 17: Media Entry Assemblies

Take-Up Reel Assembly

Reference on Figure	HP Part Number	Part Description	Size	Page ^a
1	Q6706-60902	Take-Up Reel Deflector Support Assembly	All	585
2	Q6706-60904	Take-Up Reel Left Hand Module (includes Motor)	All	582
3	Q6706-60910	Thumbscrew	All	587
4	Q6706-60909	Take-Up Reel Receiver Sensor Housing Assembly	All	587
5	Q6706-60908	Take-Up Reel Sensors Assembly	All	587
6	CH955-67033	Take-Up Reel Spindle Assembly ^b	42-inch	
	CH956-67012		60-inch	
7	CH955-67082	Take-Up Reel Shelf	42-inch	
	CH956-67032		60-inch	
8	Q6706-60906	Take-Up Reel Tubes Assembly	42-inch	
	Q6652-60902		60-inch	
9	Q6706-60901	Take-Up Reel Spindle Hubs	All	
10	Q6706-60903	Take-Up Reel Left Hand Module	All	584

a. Refers to the page in the Removal and Installation Chapter (if applicable)

b. Includes the Take-up Reel tubes. Not including the Take-Up Reel Spindle Hubs

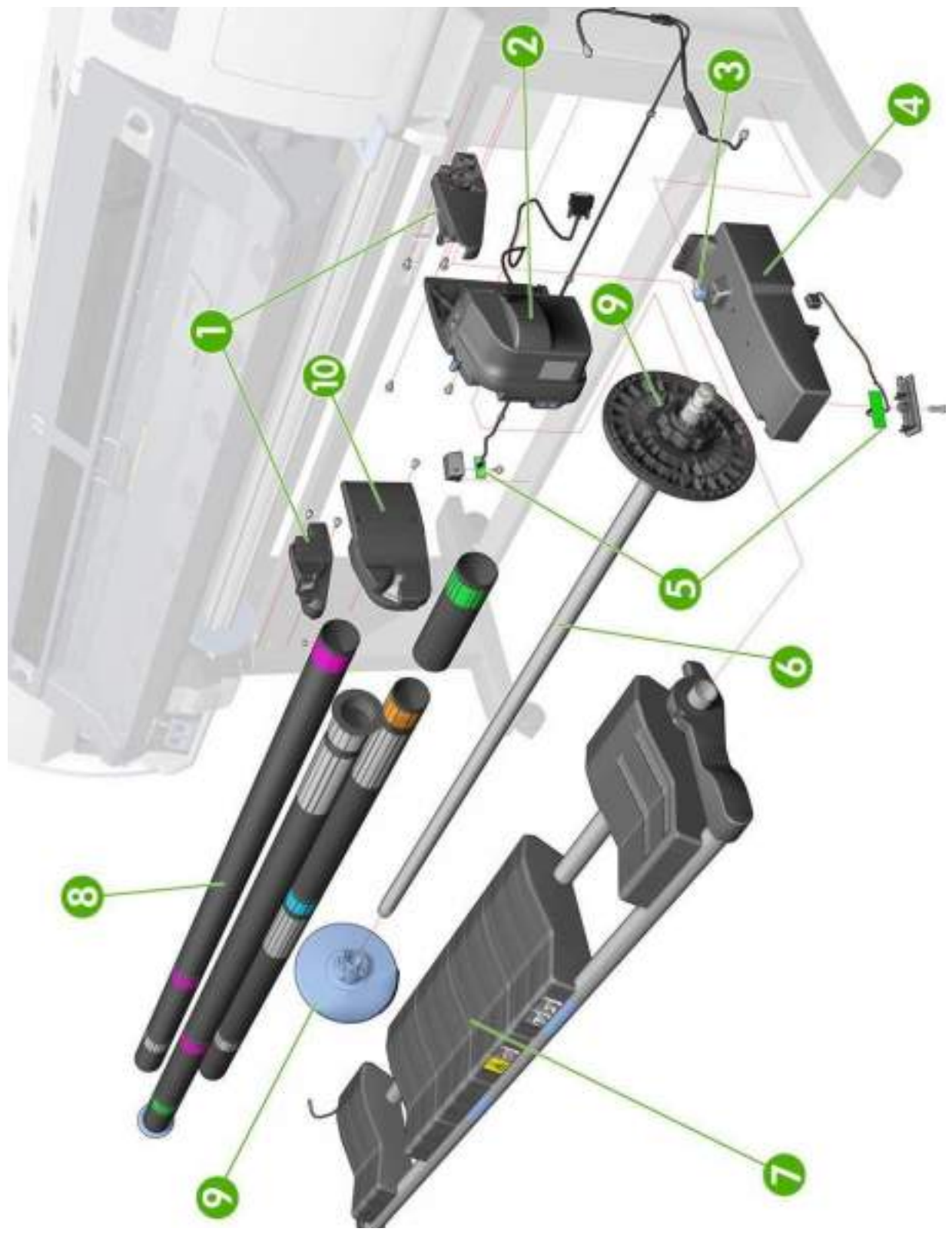

Figure 18: Take-Up Reel Assembly

Miscellaneous Parts

Reference on Figure	HP Part Number	Part Description	Size	Page ^a
1	Q1273-60097	Right Arc	All	579
2	Q1273-60098	Left Arc	All	579
-	CH955-67070	User's Maintenance/cleaning kit ^b	All	
-	CH955-67068	Service Maintenance Kit # 1:	42-inch	N/A
	CH956-67024	<ul style="list-style-type: none"> • Scan-Axis Motor (see page 419) • Encoder Strip & Sensor (see page 399) • Ink Tubes Assembly & Trailing cable (see page 380) • Belt & Tension Kit Assembly (see page 418). • Carriage Assembly without PCA, Cutter, and Color Sensor (see page 408) • Line Sensor (see page 486) • Carriage PCA cover (see page 408) • Paper Jam sensor (see page 413) 	60-inch	
-	CH955-67069	Service Maintenance Kit # 2: <ul style="list-style-type: none"> • Aerosol Filter (see page 373) • Service Station (see page 364) • Color Sensor (see page 488) • Line Sensor (see page 486) • Paper Jam sensor (see page 413) • Spittoon Assembly (see page 376) 	60-inch	N/A
-	CH955-67077	Service Maintenance Kit # 3: <ul style="list-style-type: none"> • Aerosol Fan & Filter (see page 373) • Line Sensor (see page 486) 	ALL	N/A
-	CH955-67003	Labels Kit (including S/N number)	All	N/A
-	Q1273-60296	2 Sheets of HP Universal Instant.dry Gloss Photo media for Service Advance Calibration and OMAS Calibration	All	N/A

a. Refers to the page in the Removal and Installation Chapter (if applicable)

b. This accessory is available to be purchased by the customer

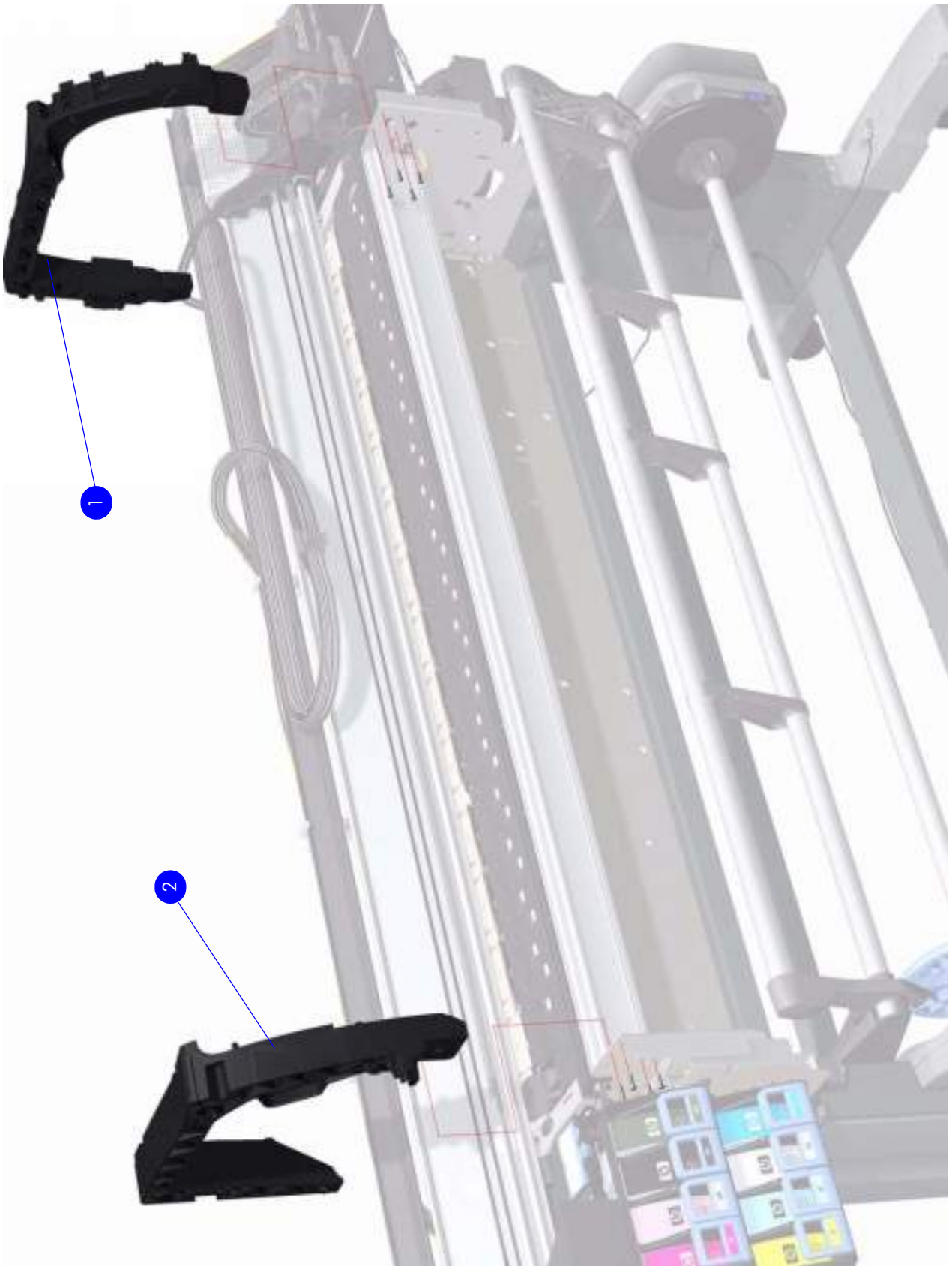

Figure 19: Arc Assemblies

8 Removal & Installation

Two contents lists are provided for this chapter to help you to quickly find the service part you want to replace. The first list is provided in *Service Part Order* and the second in *Disassembly Order*.

Service Part Order

• Introduction	307
• Screw Types	308
• AC Input Assembly	478
• Aerosol Fan and Filter	373
• APS Assembly	395
• Belt Assembly	418
• Carriage Assembly	408
• Carriage Flex Cables	405
• Carriage PCA	402
• Cartridge Tray	548
• Center Guide	571
• Center Platen	538
• Circuit Breakers	476
• Color Sensor Actuator Assembly	492
• Color Sensor Assembly	488
• CPU Fan	446
• Curing Fans & Cover	503
• Curing Heaters	515
• Curing Holders	535
• Curing Module & Curing Fans Assembly	525
• Curing Fans & Cover	503
• Cutter Assembly	386
• Drive Roller	573
• Drop Detector	377
• Dryer (IR) Temperature Sensor	496
• Dryer Heater	498
• Electronics Module Extension (60-inch only)	344
• Electronics Module	483
• Encoder Disc and Sensor	557
• Encoder Strip and Encoder Sensor	399
• Formatter Battery	464
• Front Panel	353

Service Part Order (Continued)

• Hard Disk Drive (HDD).....	452
• Heaters Control Assembly	465
• Heaters Control Assembly Fan	473
• Hinge Brakes.....	316
• Ink Supply Station (ISS)	388
• Ink Supply Tubes and Trailing Cable.....	380
• Input Roller.....	550
• Interconnect PCA	435
• ISS to Cartridge Cables	385
• Left Connector Cover (42-inch)	343
• Left Cover.....	325
• Left Curing Cover	328
• Left Rollfeed Module Assembly.....	580
• Left Trim	327
• Line Sensor Assembly	486
• Main PCA Formatter.....	450
• Media Jam Sensor, cable & Carriage Reflector Assembly	413
• CPU Fan	446
• Printhead Maintenance Cartridge Door.....	553
• Top Cover Fans.....	349
• Media Lever Assembly	560
• Media Lever Sensor.....	563
• Media Sensor.....	555
• Media-Axis Motor	422
• Memory Module	448
• OMAS Cable	439
• OMAS Controller Card	437
• Optical Media Advance Sensor (OMAS)	424
• Output Platen	533
• TOMAS: Temperature Optical Media Advance Sensor	431
• TOMAS Cable.....	433
• PATA to SATA PCA	454
• Pinchwheel Assembly.....	565
• Power Supply Unit (PSU).....	456
• Primer Assembly	355
• Primer Valves.....	357
• Formatter Battery.....	464
• Rear Cover.....	332
• Rear Fans.....	351
• Rewinder	361
• Right Connector Cover.....	341

Service Part Order (Continued)

• Right Cover.....	319
• Right Curing Cover	330
• Right Rollfeed Module Assembly	579
• Right Trim	322
• Sausalito PCI PCA	444
• Scan-Axis Motor.....	419
• Service Station	364
• Take-Up Reel Deflector Supports	585
• Take-Up Reel Left Hand Module.....	584
• Take-Up Reel Motor	582
• Take-Up Reel Sensors	587
• TOMAS: Temperature Optical Media Advance Sensor	431
• TOMAS Cable	433
• Top Cover	334
• Top Cover Fans	349
• Vacuum Fan.....	370
• Waste Ink Tube	376
• Web Wipe Assembly.....	368
• Window.....	311
• Window Lock Sensor Right	347
• Window Lock Sensor Left.....	345

Disassembly Order

• Introduction	307
• Screw Types	308
• Window	311
• Hinge Brakes	316
• Right Cover	319
• Right Trim	322
• Left Cover	325
• Left Trim	327
• Left Curing Cover	328
• Right Curing Cover	330
• Rear Cover	332
• Top Cover	334
• Right Connector Cover	341
• Left Connector Cover (42-inch)	343
• Electronics Module Extension (60-inch only)	344
• Window Lock Sensor Left	345
• Window Lock Sensor Right	347
• Top Cover Fans	349
• Rear Fans	351
• Front Panel	353
• Primer Assembly	355
• Primer Valves	357
• Rewinder	361
• Service Station	364
• Web Wipe Assembly	368
• Vacuum Fan	370
• Aerosol Fan and Filter	373
• Waste Ink Tube	376
• Drop Detector	377
• Ink Supply Tubes and Trailing Cable	380
• ISS to Cartridge Cables	385
• Cutter Assembly	386
• Ink Supply Station (ISS)	388
• APS Assembly	395
• Encoder Strip and Encoder Sensor	399
• Carriage PCA	402
• Carriage Flex Cables	405
• Carriage Assembly	408
• Belt Assembly	418
• Scan-Axis Motor	419

Disassembly Order (Continued)

• Media-Axis Motor	422
• Optical Media Advance Sensor (OMAS)	424
• TOMAS: Temperature Optical Media Advance Sensor	431
• TOMAS Cable	433
• Interconnect PCA	435
• OMAS Controller Card	437
• OMAS Cable	439
• Sausalito PCI PCA	444
• CPU Fan	446
• Memory Module	448
• Main PCA Formatter	450
• Hard Disk Drive (HDD)	452
• PATA to SATA PCA	454
• Power Supply Unit (PSU)	456
• Formatter Battery	464
• Heaters Control Assembly	465
• Heaters Control Assembly Fan	473
• Circuit Breakers	476
• AC Input Assembly	478
• PrintMech PCA	482
• Electronics Module	483
• Line Sensor Assembly	486
• Color Sensor Assembly	488
• Color Sensor Actuator Assembly	492
• Dryer (IR) Temperature Sensor	496
• Dryer Heater	498
• Curing Fans & Cover	503
• Curing Fans & Cover	503
• Curing Heaters	515
• Curing Module & Curing Fans Assembly	525
• Output Platen	533
• Center Platen	538
• Cartridge Tray	548
• Input Roller	550
• Printhead Maintenance Cartridge Door	553
• Media Sensor	555
• Encoder Disc and Sensor	557
• Media Lever Assembly	560
• Media Lever Sensor	563
• Pinchwheel Assembly	565
• Individual Pinchwheel Rollers	568

Disassembly Order (Continued)

- Center Guide 571
- Drive Roller 573
- Right Rollfeed Module Assembly..... 579
- Left Rollfeed Module Assembly 580
- Take-Up Reel Motor 582
- Take-Up Reel Left Hand Module 584
- Take-Up Reel Deflector Supports..... 585
- Take-Up Reel Sensors..... 587

Introduction

This chapter is a step-by-step guide to the removal and installation of the key components of the printer. You may find it useful to tick off the steps as they are performed. Use the illustrations for each procedure to identify the parts referred to in the text.

The procedures appear in order of removal. So the whole machine can be stripped down by starting at the beginning of this chapter and working through the subsequent procedures.



NOTE: Before using this chapter to remove and install a new component, always make sure that you have performed the relevant service test from Chapter 4. If the test passes you will not need to replace the component.

Safety Precautions

Review the instructions identified by WARNING and CAUTION symbols before you service the printer. Follow these warnings and cautions for your protection and to avoid damaging the printer.



WARNING! Serious shock hazard leading to death or injury may result if you do not take the following precautions:

- Ensure that the AC power outlet (mains) has a protective earth (ground) terminal.
- Switch the plotter off, and disconnect it from the power source prior to performing any maintenance.
- Prevent water or other liquids from running onto electrical components or circuits, or through openings in the module.

Electrostatic Discharge (ESD) Precautions

To prevent damage to the Printer circuits from high-voltage electrostatic discharge (ESD):

1. Do not wear clothing that is subject to static build-up.
2. Do not handle integrated circuits (ICs) in carpeted areas.
3. Do not remove an IC or a printed circuit assembly (PCA) from its conductive foam pad or conductive packaging until you are ready to install it.
4. Ground (earth) your body while disassembling and working on the Printer.
5. After removing a cover from the Printer, attach an earthing (ground) lead between the PCA common and earth ground. Touch all tools to earth ground to remove static charges before using them on the Printer.
6. After removing any PCA from the Printer, place it on a conductive foam pad or into its conductive packaging to prevent ESD damage to any ICs on the PCA.

Required Tools

The following tools are required to disassemble and repair the Printer.

- A long Torx Screwdriver with the following attachments: T8, T10, T15, T20, and T25.
- A long thin-bladed T-10 Torx Screwdriver to remove the Primer. The blade must be longer than 12 cm with a maximum diameter of 10 mm.
- A long thin-bladed T-20 Torx Screwdriver to remove the OMAS Sensor. The blade must be longer than 11 cm with a maximum diameter of 4 mm.
- A T8 Torx Screwdriver to remove the left cover. The blade must be longer than 5 cm with a maximum diameter of 9 mm.

Screw Types

Type	Torx	Length (mm)	Head Type	Thread Type	Part Number
A	T-20	17	Pan	Taptite	0515-1743
B	T-20	10	Pan	Taptite	0515-2282
C	T-10	7.0	Pan	Machined	0515-4613
D	T-8	5.5	Pan	Taptite	0515-2850
E	T-15	-	Pan	-	C3180-20001
F	T-15	9.5	Pan	Plastite	0515-2981
G	T-15	12.7	Pan	Taptite	0624-0769
H	T-15	12.7	Pan	Taptite	0515-4706
I	T-10	8.0	Pan	Taptite	0515-2200
J	T-15	20	Pan	Plastite	0624-0771
K	T-8	9.5	Pan	Taptite	0624-0680
L	T-8	12.7	Pan	Taptite	0624-0768
M	T-20	-	Pan	-	0515-2521
N	T-20	35	Pan	Sheet Metal	C6071-20025
O	T-20	12.7	Pan	-	0624-1062
P	T-15	11.6	Pan	Machined	C2847-20018
Q	T-20	-	Pan	Taptite	0515-2916
R	T-15	-	Pan	Taptite	0515-1916
S	T-15	18.4	Pan	Machined	Q6651-20179

Opening the Window



WARNING! Before opening the Window, observe all safety precautions when working in the area of the Dryer Assembly. Make sure that the temperature of the print zone has sufficiently cooled down.



1. Switch off the printer from the on/off switch and remove both power cables from the back of the printer.



1. Unlock the two Window Locks



2. Open the Window.



3. Wait five minutes for the printer to cool down.

Window

Removal



WARNING!: Switch off the printer and remove the power cable.



1. Open the Window ⇒ See page 309.
2. Remove the Left Cover ⇒ See page 325.
3. Remove one T20 screw from a cable clamp.
4. Loosen two screws on the connector of the Dryer IR Temperature Sensor cable, by hand or with a flat screwdriver, and disconnect.
5. Remove one T25 screw, one lock washer, one normal washer that secures the grounding cable.



WARNING!: To ensure the electrical safety of the Printer, it is very important that this grounding cable is reinstalled after the new part has been installed.



WARNING!: When reinstalling the grounding cable, it is an important safety point that the washer is installed between the printer and the grounding cable.



6. Push the grounding cable to one side.



7. Remove one T-20 screw from a cable clamp that secures the grounding and Dryer Temperature Sensor cable to the left Arc.

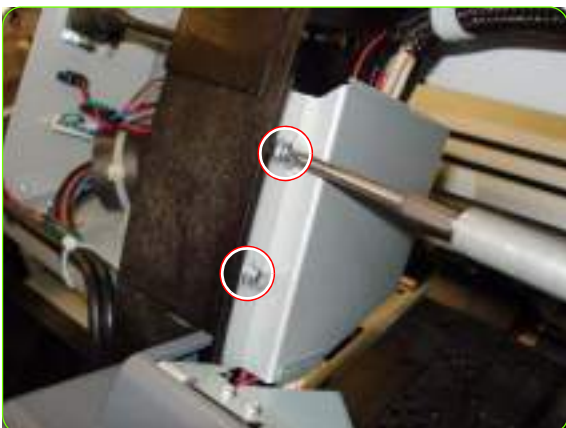

8. Remove two T-20 screws that secure the Left Cable Plate to the printer.



9. Lift up the Left Cable Plate



10. Remove the Left Cable Plate.

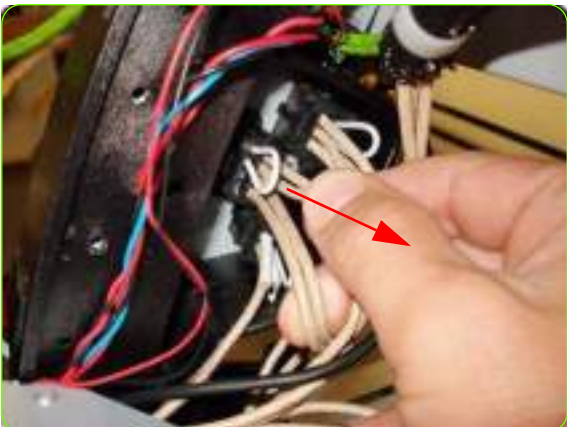

11. Disconnect the Dryer Power Cable.



12. Close slightly the Window

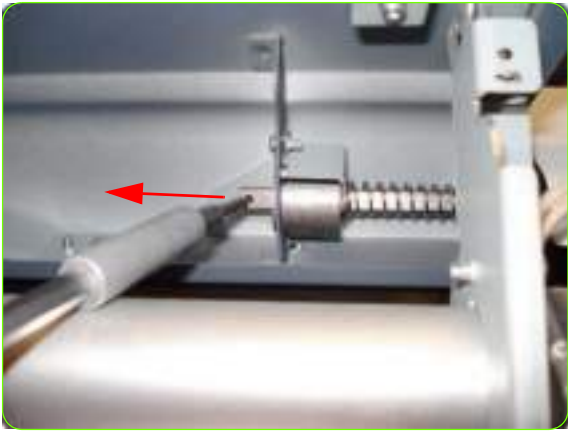

13. Disengage the Right Hinge Brake.

TIP: To disengage the brake, slowly open the Window, at the same time, insert an Wrench Key or small screwdriver into a hole in the Hinge Shaft and slide it to the left.



14. Slide the shaft all the way to the left until its disengaged.



15. The right side of the Window is now loose.



16. Remove the Left Hinge Brake by inserting a small Wrench Key or screwdriver into a hole in the Hinge Shaft and slide it to the right.

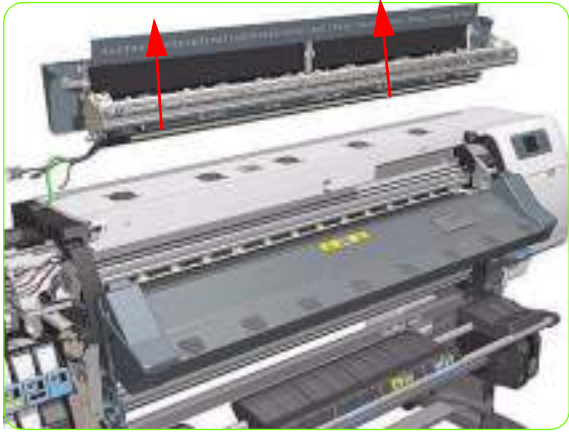

17. Remove the Window.

Hinge Brakes

Removal



WARNING!: Switch off the printer and remove the power cable.

1. Remove the Left Cover ⇒ See page 325.
2. Remove the Window ⇒ See page 311.
3. Remove two T-15 screws from the Right Hinge Brake.



4. Remove one T-15 screw from the back of the Right hinge Brake.



NOTE: A long screw driver attachment is required to remove this screw



5. Remove the Right Hinge Brake.



6. Remove four T-20 screws from the grill of the Top Cover Left Fan.



7. Remove the grill of the Top Cover Left Fan.



8. Leave the Top cover Left Fan and diffuser on the platen.



9. Remove two T-15 screws from the Left Hinge Brake.



10. Remove one T-15 screw from the back of the Left Hinge Brake.



NOTE: A long screw driver attachment is required to remove this screw.



11. Remove the Left Hinge Brake.

Right Cover

Removal



WARNING! Switch off the printer and remove the power cable.



1. Using a suitable small flat-blade screwdriver, unclip the Front Panel Bezel from the Right Cover.



2. Remove the Front Panel Bezel from the Right Cover.



3. Remove two T-15 screws (**Type G**) that secure the Front Panel to the Right Cover.



4. Open the Maintenance Cartridge Door.
5. Remove one T-15 screw (**Type J**) that secures the Right Cover.
6. Open the Window ⇒ See page 309.
7. Remove one T-15 screw (**Type J**) that secures the Right Cover.

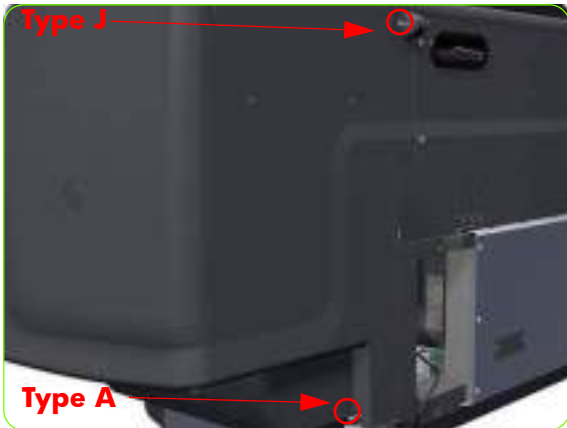

8. Remove one T-15 screw (**Type J**) that secures the Right Cover.

9. Remove one T-15 screw (**Type J**) and one T-20 screw (**Type A**) that secure the Right Cover from the rear of the Printer.

10. Remove the Right Cover from the Printer.



CAUTION: When installing the Right Cover, make sure you leave the Printhead Maintenance Cartridge Door open, otherwise you could damage the sensor of the door.

Right Trim

Removal



WARNING!: Switch off the printer and remove the power cable.

1. Remove the Right Cover ⇒ See page 319.
2. Remove the Output Platen ⇒ See page 533.
3. Raise the Media Lever.
4. Remove one T-15 screw (**Type F**) that secures the Media Lever to the Linkage.
5. Disconnect the Media Lever from the Linkage.





6. Remove one T-20 screw (**Type F**) that secures the Media Lever to the Right Trim.



7. Remove the Media Lever from the Printer.



8. Unroute the cable of the Media Lever Position Sensor from its clip to avoid putting strain on the Media Lever Position Sensor connections during the removal of the Right Trim.



9. Remove two T-20 screws that secure the Right Trim.



10. Carefully remove the Right Trim sufficiently to gain access to the Media Lever Position Sensor.

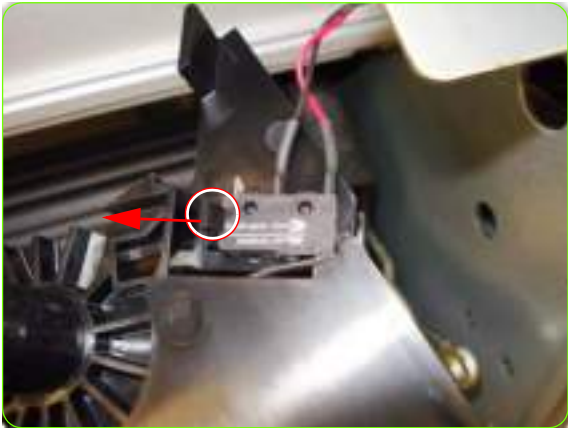

11. Unclip the Media Lever Position Sensor of its mounting lugs on the Right Trim.



12. Remove the Right Trim from the Printer.

Left Cover

Removal



WARNING! Switch off the printer and remove the power cable.



1. Open the Window ⇒ See page 309.



2. Remove one T-15 (**Type J**) screw that secures the Left Cover at the top.



3. Remove one T-15 (**Type J**) screw that secures the Left Cover at the bottom.

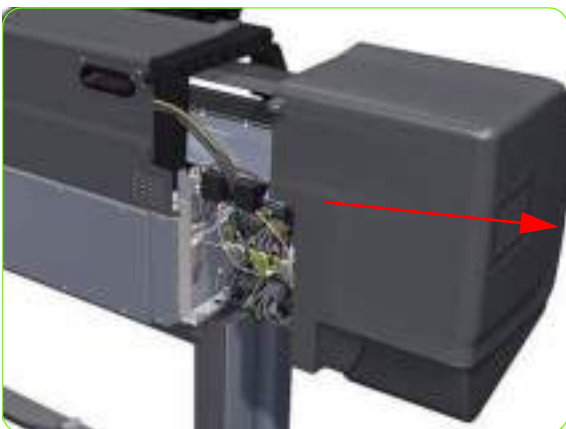

4. Remove one T-20 screw (**Type J**) that secures the Left Cover.
5. Remove one T-15 screw (**Type J**) that secures the Left Cover.
6. Remove one T-20 screw (**Type J**) that secures the Left Cover.
7. Remove the Left Cover from the Printer.

Left Trim

Removal



WARNING! Switch off the printer and remove the power cable.



1. Remove the Output Platen ⇒ See page 533.
2. Remove three T-20 screws that secure the Left Trim.



3. Carefully remove the Left Trim from the Printer.

Left Curing Cover

Removal



WARNING!: Switch off the printer and remove the power cable.



1. Open the Window ⇒ See page 309.



2. Remove three T-20 screws from the Left Curing Cover.



3. Remove one T-10 screw from the Left Curing Cover.



4. Remove Left Curing Cover by sliding it off.

Right Curing Cover

Removal



WARNING!: Switch off the printer and remove the power cable.



1. Open the Window ⇒ See page 309.



2. Remove three T-20 screws from the Right Curing Cover.



3. Remove one T-10 screw from the Right Curing Cover.



4. Remove Right Curing Cover.

Rear Cover

Removal



WARNING!: Switch off the printer and remove the power cable.

1. Remove the Right Cover ⇒ See page 332
2. Remove the Left Cover ⇒ See page 325.
3. 42" Printer remove five T-20 screws (**Type G**) and the four T-15 screws (**Type X**) from the Rear Cover.
60" Printer remove seven T-20 screws (**Type G**) and the four T-15 screws (**Type X**) from the Rear Cover.



NOTE: Each Type X screw includes a washer (part number 3050-1267).

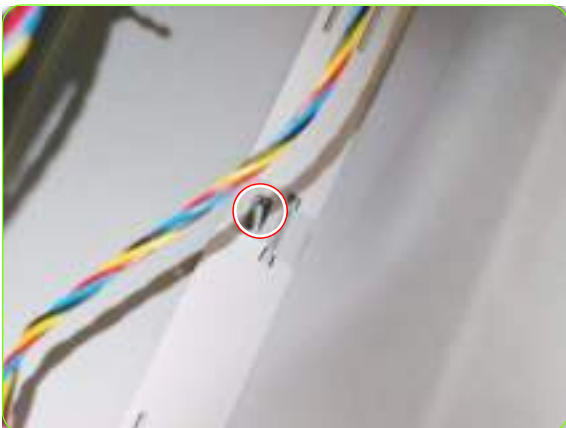
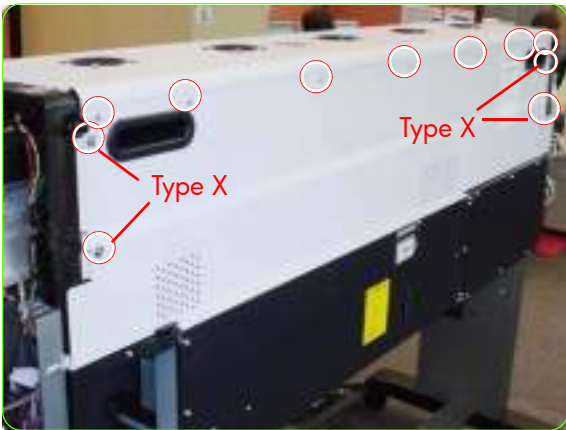

4. Open the Rear Cover slightly (as shown, approximately 30 degrees).
5. Lift the left side of the rear cover sufficiently to release it from the location stud. The 60" version contain three.



6. Remove the Rear Cover from the Printer.

Top Cover

Removal



WARNING!: Switch off the printer and remove the power cable.

1. Remove the Right Cover ⇒ See page 319.
2. Remove the Left Cover ⇒ See page 325.
3. Remove the Rear Cover ⇒ See page 332.
4. Release the clip securing the Ink Supply Tubes and the Trailing cable to the Top Cover.



5. Release the Ink Supply Tubes and Trailing Cable from the clip underneath the Top Cover.



6. Press the clip to release it from the Top Cover.



7. Remove the clip from the Top Cover.



8. Unroute the Trailing Cable from the Top Cover.



9. Position the Ink Supply Tubes so they are resting on the Platen.



10. Remove four T-10 screws from the grill of the most Left Top Cover Fan.



11. Remove the grill.



12. The Left Top Cover Fan and Diffuser is now loose.



13. Disconnect the cable from the Left Top Cover Fan.



14. Remove the Left Top Cover Fan and Diffuser.

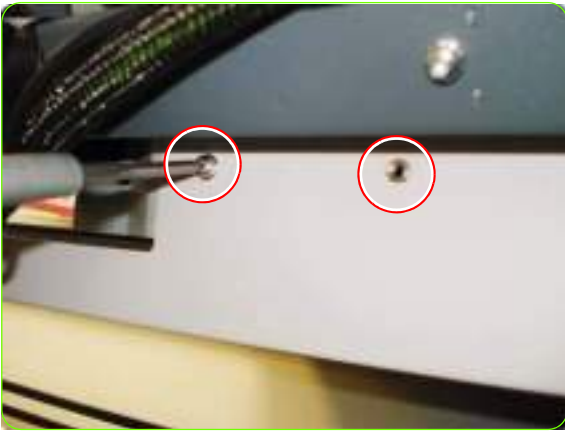

15. Remove two T-20 screws that secure the front plate to the front of the Top Cover.



16. Remove the front plate



17. Remove one T-10 screw that secures the earth cable to the left side of the printer.

18.



19. Disconnect the cable of the Top Cover Fans.

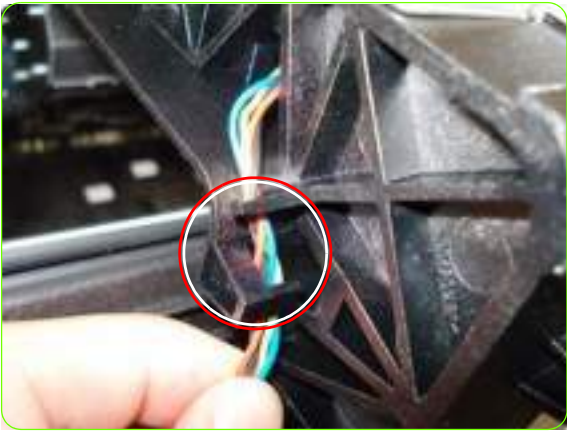

20. Remove the cable of the Top Cover Fans from a 2nd clip on the rear of the Left Arch.

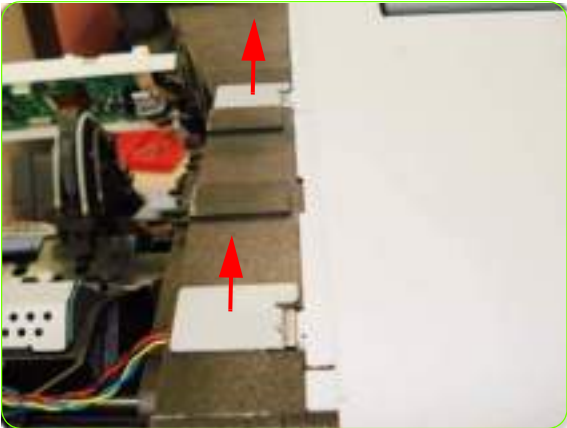

21. Remove the two locking plates.



22. Lift up the right end of the Top Cover to release it from the right arch.



23. Close the Window.

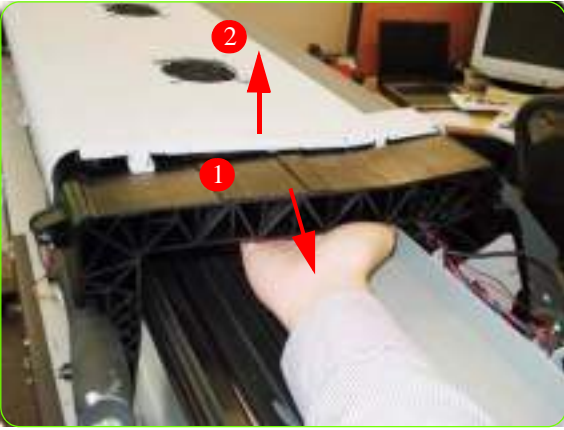

24. Slide the Top cover to the Left (1) and then raise the Top Cover (2).

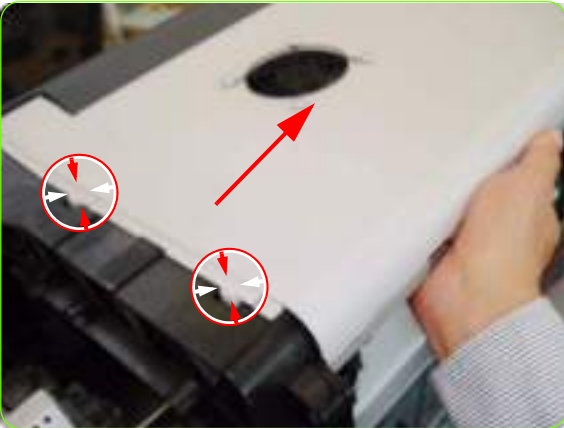

25. Slide the Top Cover in the direction of the arrow to release the two locking clips.



26. Remove the clip from the right arch.



27. Move the cable to the side.



28. Push the cable of the Top Cover Fans through a hole in the right Arch.



29. Remove the Top Cover.

Right Connector Cover

Removal



WARNING! Switch off the printer and remove the power cable.



1. For the 60-inch model, and optionally the 42-inch model, disconnect the TUR connector.



2. For the 60-inch model, and optionally the 42-inch model, unroute the TUR cable from the Right Connector Cover.



3. Remove two T-20 screws (**Type B**) from the Right Connector Cover.



4. Rotate the Right Connector Cover a few degrees counter-clockwise so it can be removed completely.



5. Remove the Right Connector Cover from the Printer.

Left Connector Cover (42-inch)

Removal



WARNING! Switch off the printer and remove the power cable.

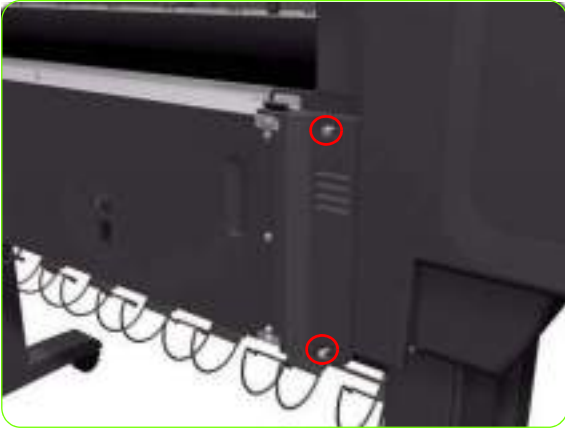

1. Remove two T-20 screws (**Type B**) from the Left Connector Cover.



2. Remove the Left Connector Cover from the Printer.

Electronics Module Extension (60-inch only)

Removal



WARNING!: Switch off the printer and remove the power cable.

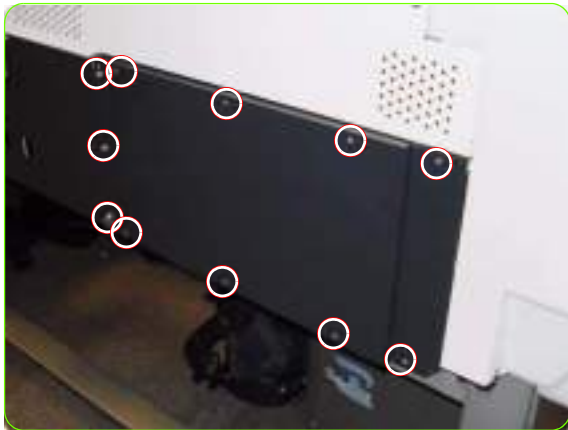

1. Remove ten T-20 screws (**Type B**) from the Electronics Module Extension.



2. Rotate the Electronics Module Extension approximately 90 degrees counter-clockwise.



3. Remove the Electronics Module Extension from the Printer.

Window Lock Sensor Left

Removal



WARNING! Switch off the printer and remove the power cable.

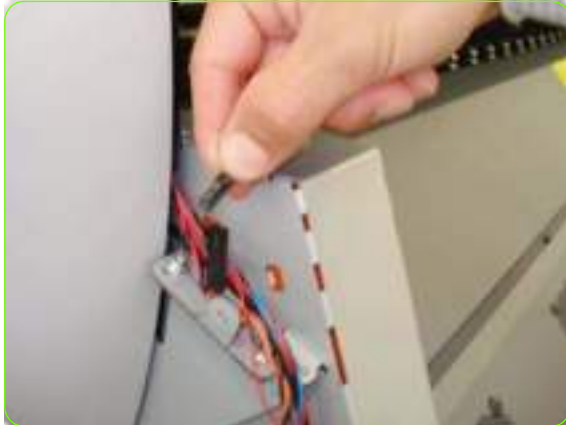

1. Remove the Left Curing Cover⇒ See page 328.
2. Disconnect the Left Window Lock Sensor.
3. Remove the cable of the Left Window Lock Sensor from a holding point on the Left Curing Cover.
4. Remove two T-8 screws that secure the Left Curing Sensor.



5. Remove a metal plate from the Left Curing Sensor.



6. Remove the Left Window Lock Sensor.

Window Lock Sensor Right

Removal



WARNING! Switch off the printer and remove the power cable.



1. Remove the Right Curing Cover⇒ See page 330.
2. Disconnect the Right Curing Sensor.
3. Remove the cable of the Right Window Lock Sensor from a holding point on the Right Curing Cover.
4. Remove two T-8 screws that secure the Right Curing Sensor.

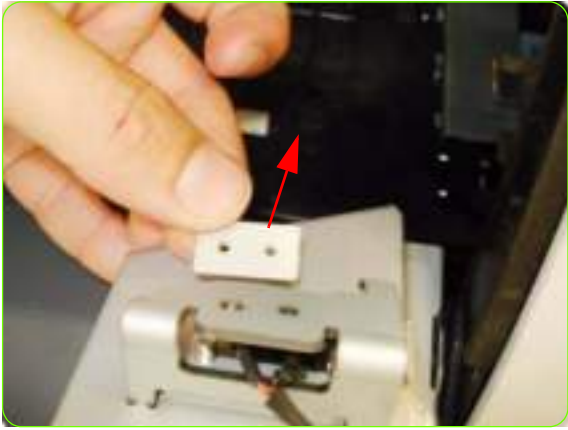

5. Remove a metal plate from the Right Curing Sensor.



6. Remove the Right Window Lock Sensor.

Top Cover Fans

Removal



WARNING! Switch off the printer and remove the power cable.

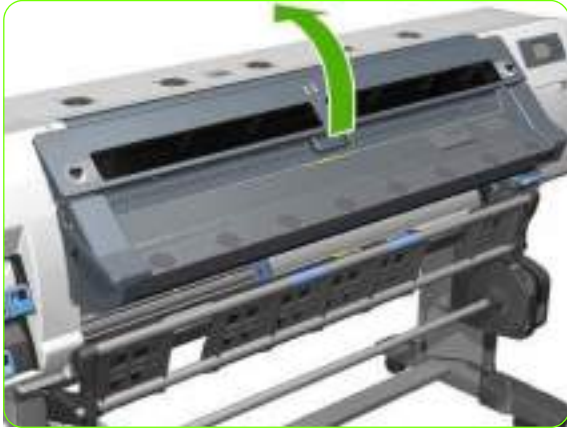

Top Left & Middle Fans

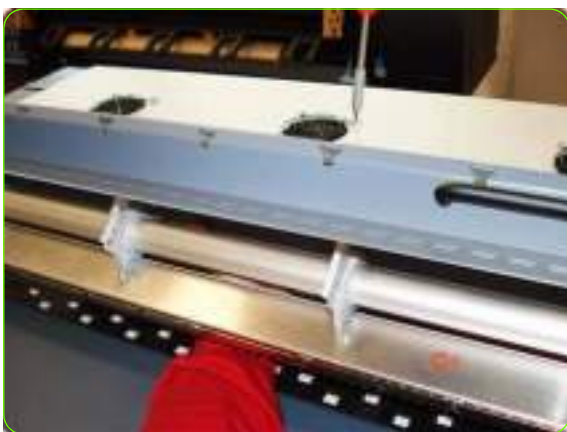

1. Open the Window ⇒ See page 309.
2. Remove four T-20 screws that secure the Top Cover Fan to the Top Cover,
3. When the last T-20 screw is being removed, support the Fan Assembly underneath with your hand to catch it.



4. Slide the Fan and Diffuser assembly towards you.



5. Disconnect the cable from Fan and Diffuser Assembly.



6. Remove the four T-15 screws that secure the Fan to the Diffuser Assembly.

Rear Fans

Removal



WARNING! Switch off the printer and remove the power cable.

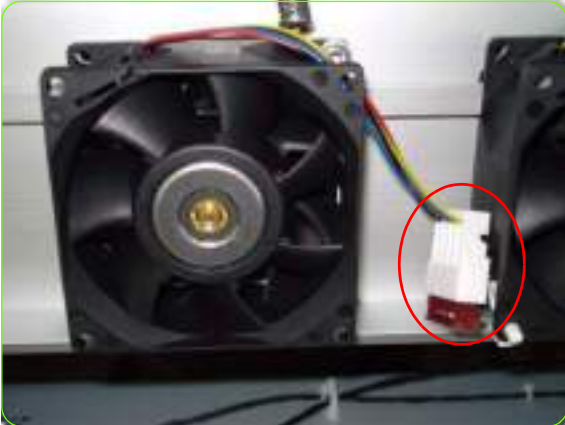

1. Remove the Rear Cover ⇒ See page 332.
2. Disconnect Rear Fan Cable.

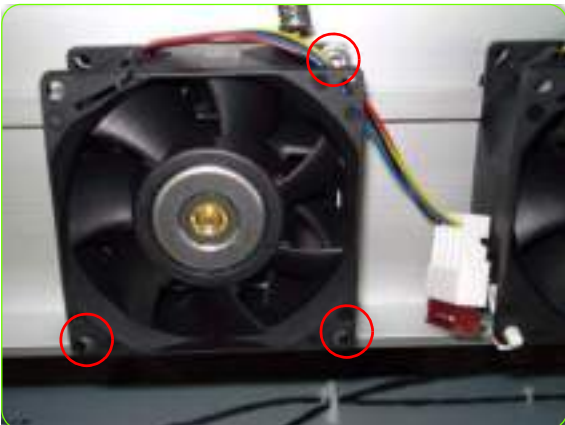

3. Remove three T-15 screws that secure the Rear Fan.



4. Remove the Rear Fan.

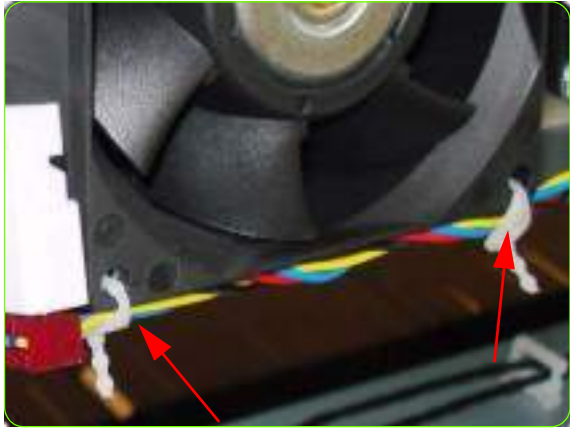

5. To remove the Rear Fan Array Cable, remove two plastic clamps to release the cable from the array of Fans.

Front Panel

Removal



WARNING! Switch off the printer and remove the power cable.

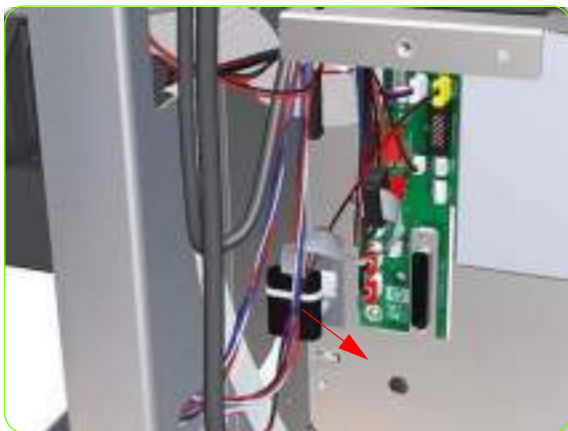

1. Remove the Right Cover ⇒ See page 319.
2. Remove the Right Connector Cover ⇒ See page 341.
3. Disconnect the Front Panel Cable from the Interconnect PCA.
4. Disconnect the Ferrite clip (located on the rear of the Electronics Module) from the front of the Printer.
5. Move the Front Panel Cable (including the ferrite) out of the Electronics Module.

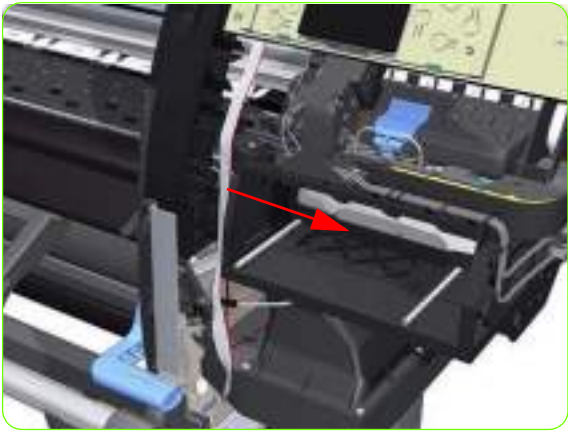

6. Release the Front Panel Cable from the Right Arc.

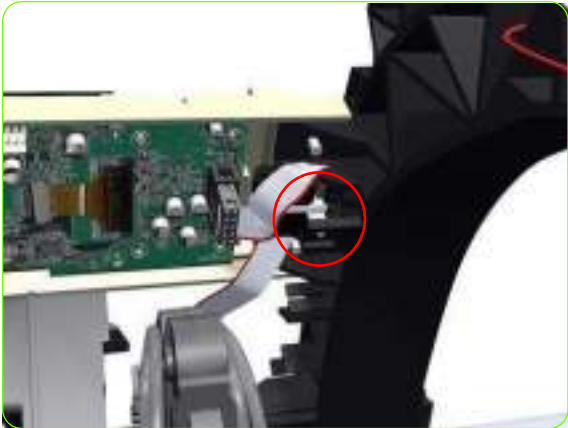

7. Disconnect the Ferrite clip from the Right Arc



8. Remove two T-15 screws (**Type G**) that secure the Front Panel to the Printer.

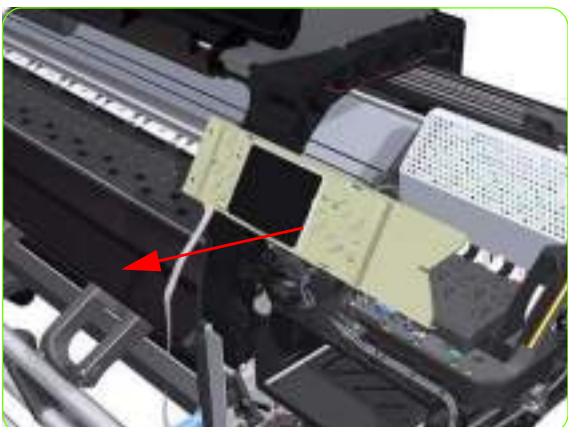

9. Remove the Front Panel from the Printer.

Primer Assembly

Removal



WARNING! Switch off the printer and remove the power cable.

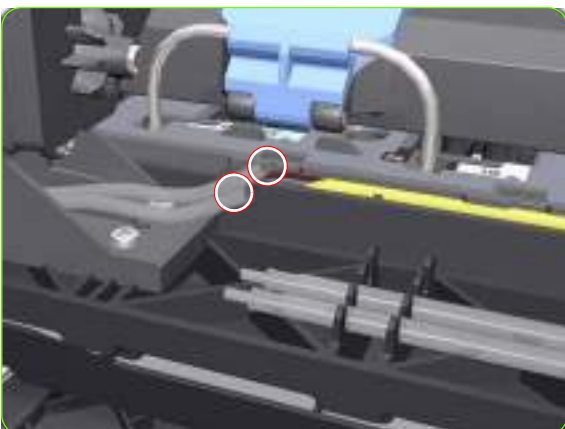

1. Remove the Right Cover ⇒ See page 319.
2. Remove the Right Connector Cover ⇒ See page 341.
3. Remove the Front Panel ⇒ See page 353.
4. Disconnect Primer Assembly cable from the from Interconnect PCA.
5. Unroute the Primer Assembly cable from the from cable clamp.
6. Disconnect the two Primer Assembly tubes.

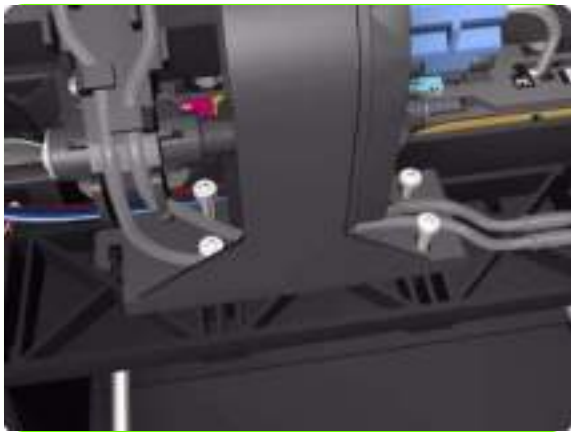

- Remove four T-10 screws that secure the Primer Assembly to the Service Station.



NOTE: Use a short screw driver, less than 10 cm in length.



- Remove the Primer Assembly from the Service Station.



NOTE: When installing the Primer Assembly, use the identification marks on the Primer Assembly Tubes to ensure they are correctly connected.

Installation of the Primer Assembly

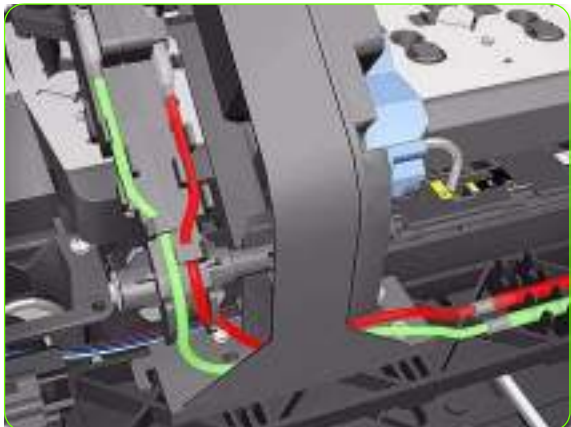

- When installing the new Primer Assembly, it is important to note that the internal tube (red) is shorter than the external tube (green).
- Reset "4.7.7. Primer Cycles" ⇒ See page 201.
- Perform the Calibration "5.6.2 Primer Calibration" ⇒ See page 220.

Primer Valves

Removal



WARNING! Switch off the printer and remove the power cable.

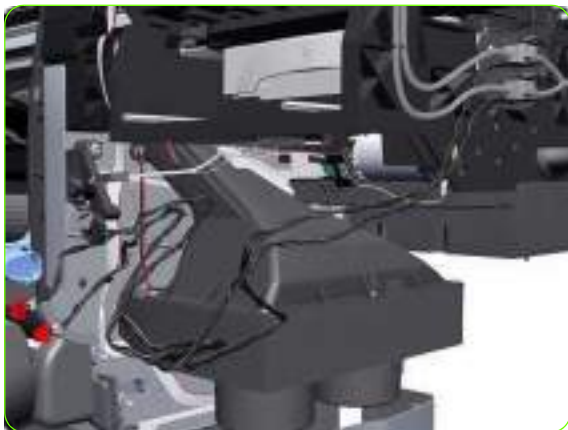

1. Remove the Right Cover ⇒ See page 319.
2. Remove the Right Connector Cover ⇒ See page 341.
3. Disconnect both Primer Valves from the from Interconnect PCA.



NOTE: The upper connection is identified as number 5 and the lower connection as number 6. These identification numbers correspond to the actual Primer Valves identification.

4. Unroute the Primer Valves cables from the from cable clamp.
5. Completely unroute the Primer Valves cables from the Service Station.

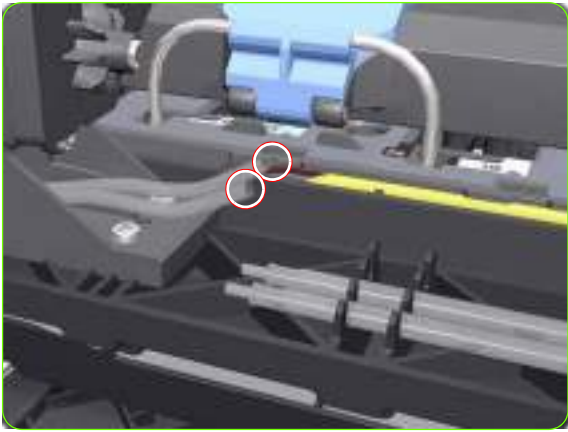

6. Disconnect the two Primer Assembly Tubes.

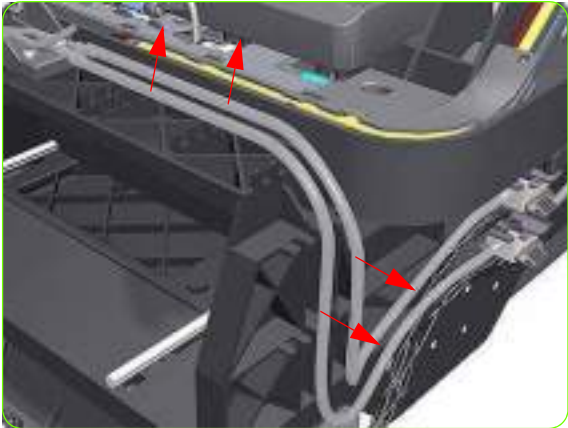

7. Unclip the Primer Valve Tubes from the Service Station.

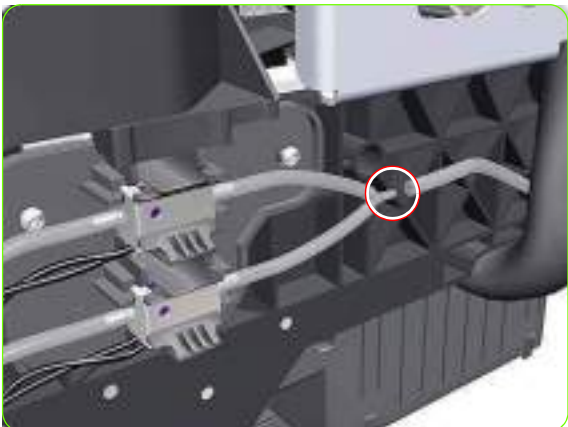

8. Disconnect the Primer Valve Tubes at the Y-Piece.

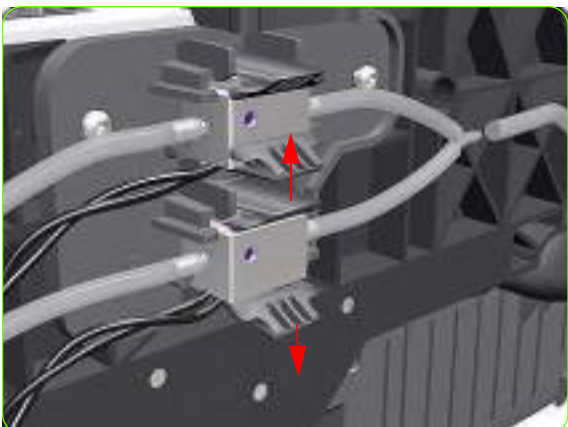

9. Unclip the lower Primer Valve.

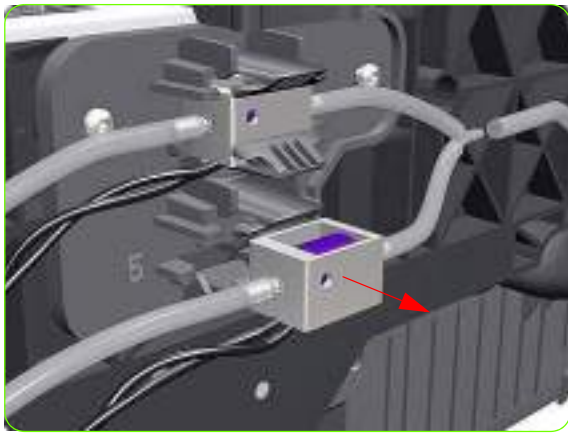

10. Remove the lower Primer Valve (identified as 5).

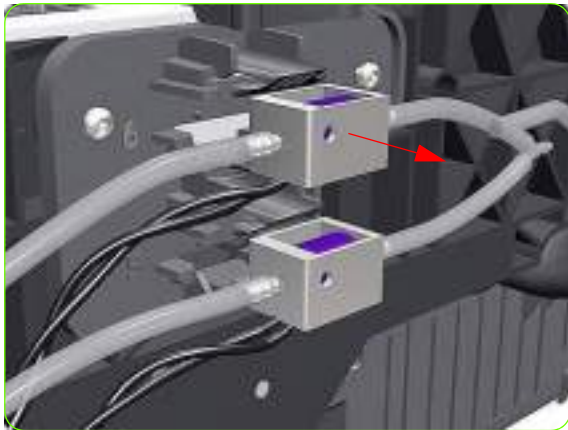

11. Unclip and remove the upper Primer Valve (identified as 6 and with an identification mark on the tube).



12. Remove the Primer Valves from the Printer.



NOTE: When installing the Primer Valves, use the identification marks on the Primer Assembly Tubes and the identification numbers to ensure they are correctly connected.

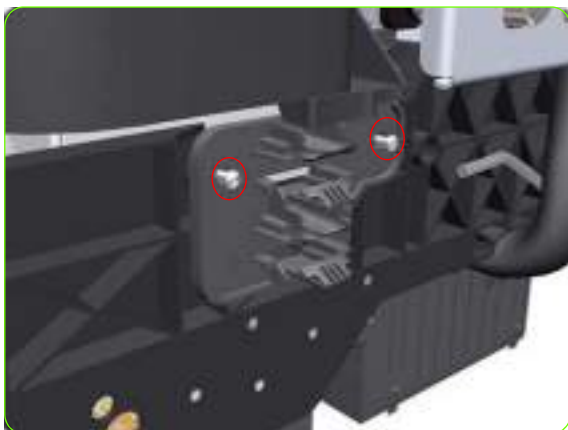

13. Remove two T-15 screws that secure the Primer Valves Mounting Plate from the printer.



14. Remove Primer Valves Mounting Plate from the printer

Installation of the Primer Assembly

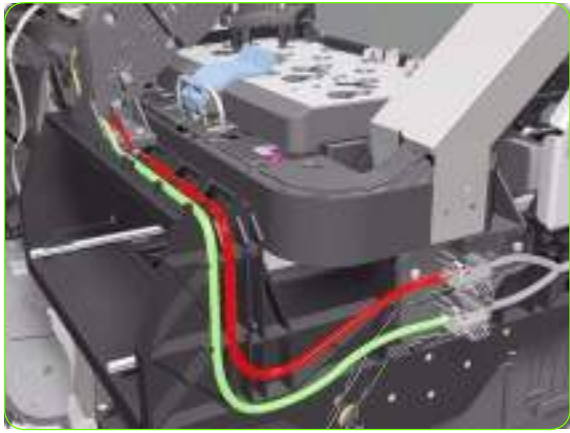

1. When installing the new Primer Assembly, it is important to note that the internal tube (red) is shorter than the external tube (green).

Rewinder

Removal



WARNING! Switch off the printer and remove the power cable.

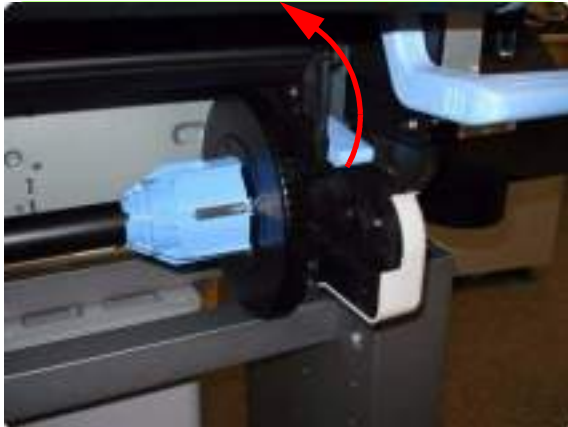

1. Remove the Right Cover ⇒ See page 319.
2. Lift up the Spindle lock and remove the Spindle
3. Remove the Right Leg Cover.
4. Disconnect the power cable from the Rewinder motor.



5. Disconnect the Black Cable from the Left side of the Rewinder Motor



6. Disconnect the Red Cable from the Right side of the Rewinder Motor.



7. Remove two T-20 screws from the left side of Rewinder Assembly..



NOTE: A long screwdriver is required to reach the screws.



8. Remove two T-20 screws from the right of Rewinder Assembly.



NOTE: A long screwdriver is required to reach the screws.



9. Remove the Rewinder Assembly making sure that you do not drop the gears.y.



NOTE: The gears of the Rewinder assembly are loose and could fall as you remove the assembly.

Installation



1. Important: Note the position of the gears when installing the Rewinder Assembly, as they can fall from the assembly while being installed.



1. When you have installed the new Rewinder Motor, ensure that the correct cables are connected to the correct terminals:

- Black cable on the left
- Red cable on the right.

To check the correct electrical installation of the Rewinder Assembly, perform the diagnostic test "3.6 Rewinder motor polarity" ⇒ See page 143.

2. Perform the following Calibrations:
 - "5.3.5 Rewinder CO voltage calibration" ⇒ See page 213.
 - "4.3.1 Rewinder motor cycles" ⇒ See page 200.

Service Station

Removal



WARNING!: Switch off the printer and remove the power cable.

1. Remove the Right Cover ⇒ See page 319.
2. Primer Assembly ⇒ See page 355.
3. Primer Valves ⇒ See page 357.
4. Remove the Drop Detector ⇒ See page 377.
5. Remove the Printhead Maintenance Cartridge ⇒ See the User's Guide.
6. Remove one T-25 screw that secures the end section of the Drain Tube above the Printhead Maintenance Container.



7. Remove one T-20 screw that secures the middle section of the Drain Tube to the rear of the Printer.



- Put the end of the Waste tube in a plastic bag and tape it securely.



- Pass the Waste Tube back through a hole in the chassis.



CAUTION: Be careful not to damage the OMAS cable.



- Disconnect the Web Wipe Motor cable.



- Disconnect the cable from the Maintenance Cartridge Door Switch.



12. Disconnect the Service Station and Aerosol Fan Cables from the Interconnect PCA.

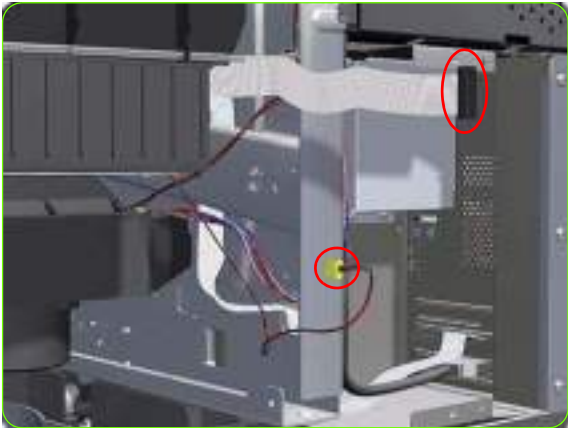

13. Unroute the Service Station and Aerosol Fan Cables.

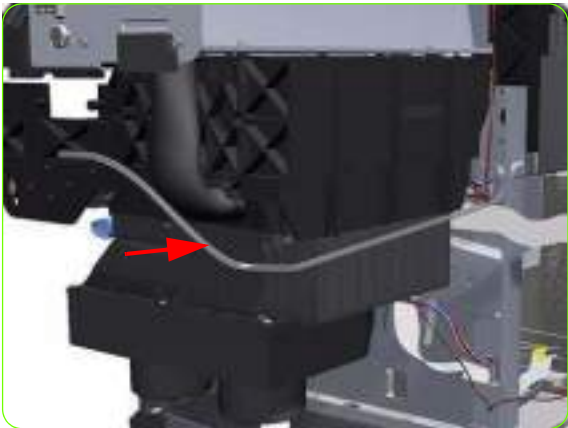

14. Unroute the Primer Assembly Valves tube from the Service Station.



15. Remove two T-15 screws (**Type J**) that secure the rear of the Service Station to the Chassis.

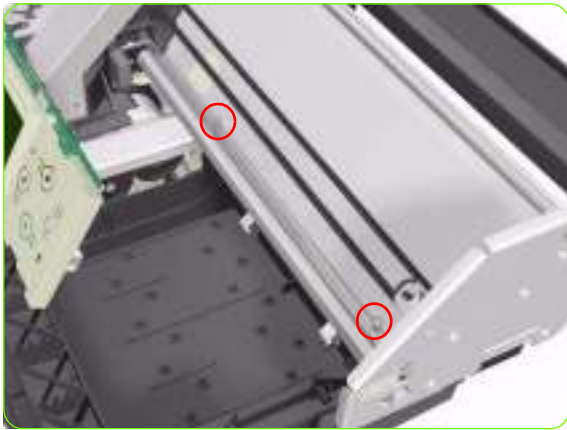

16. Remove two T-15 screws (**Type J**) that secure the Service Station to the Chassis.



CAUTION: When removing the screws, be very careful NOT to damage the Encoder Strip.

CAUTION: When removing the screws that secure the Service Station to the X-Axis, hold the Service station as it could fall when the screws are removed.



17. Remove the Service Station from the Printer.



NOTE: After installing the NEW Service Station, make sure you perform the following Service Utility:

- Reset "4.7.5 Service Station cycle counter" ⇒ page 201.

Web Wipe Assembly

Removal



WARNING!: Switch off the printer and remove the power cable.

1. Remove the Right Cover ⇒ See page 319.
2. Remove the Right Connector Cover ⇒ See page 341.
3. Remove the Primer Assembly ⇒ See page 355.
4. Remove the Primer Valves ⇒ See page 357.
5. Remove the Printhead Maintenance Cartridge ⇒ See the User's Guide.
6. Remove the Service Station ⇒ See page 364.
7. Release two clips on the right side of the Service Station.

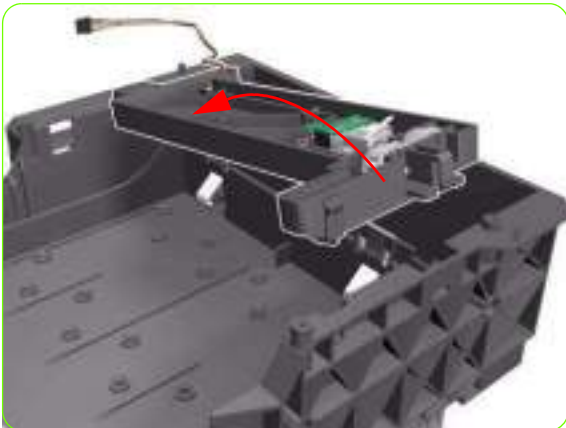
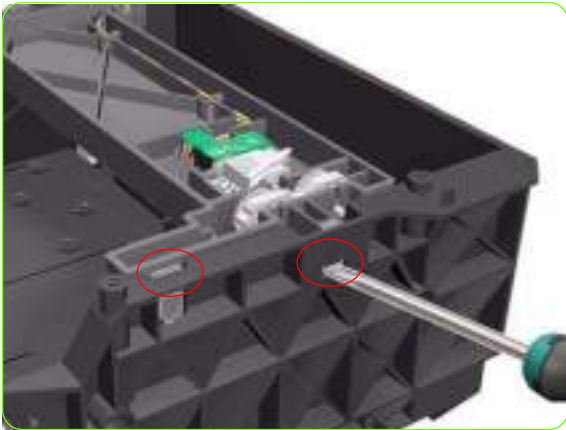

8. To release the assembly, rotate a little.



9. Remove the Web Wipe Assembly.
10. Reset "4.7.5 Service Station cycle counter" ⇒ page 201.

Vacuum Fan

Removal



WARNING!: Switch off the printer and remove the power cable.

1. Remove the Right Cover ⇒ See page 319.
2. Remove the Right Connector Cover ⇒ See page 341.
3. Remove the Primer Assembly ⇒ See page 355.
4. Remove the Primer Valves ⇒ See page 357.
5. Remove the Printhead Maintenance Cartridge ⇒ See the User's Guide.
6. Remove the Service Station ⇒ See page 364.
7. Release the Pinchwheel Lever Sensor Cable from the Vacuum Fan.

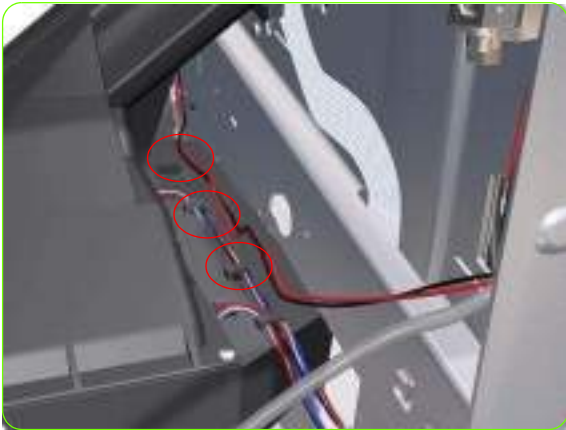

8. Disconnect both Vacuum Fan cables (identified 1 and 2) from the Interconnect PCA.



9. Unclip the cables from the cable clamp.

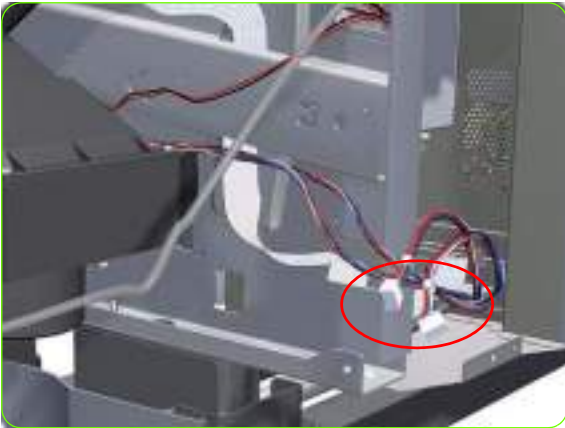

10. Unroute both Vacuum Fan cables from the Interconnect PCA.

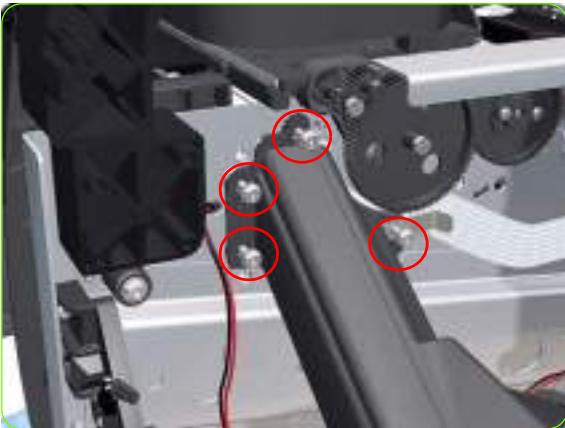

11. Remove four T-20 screws (**Type B**) that secure the Vacuum Fan to the Printer.



12. Remove the OMAS cable clamp from the printer.

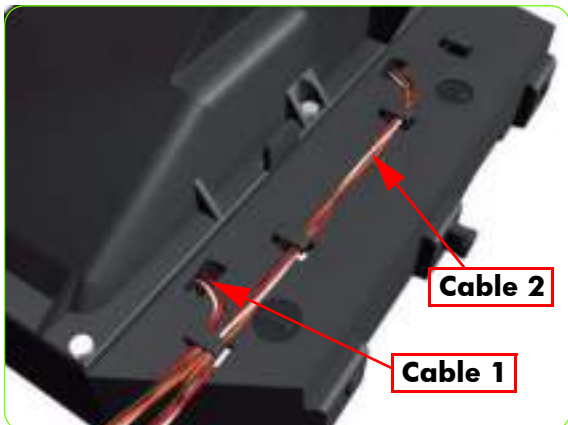
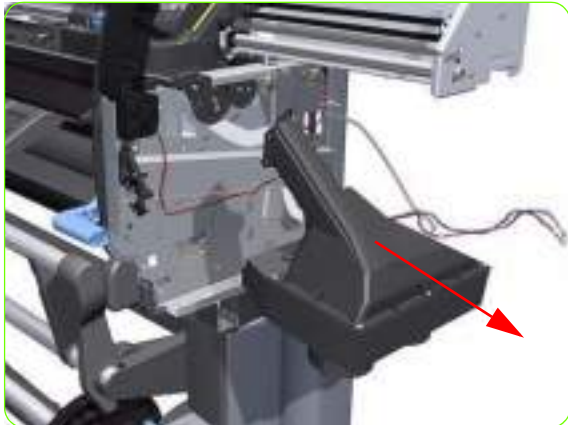
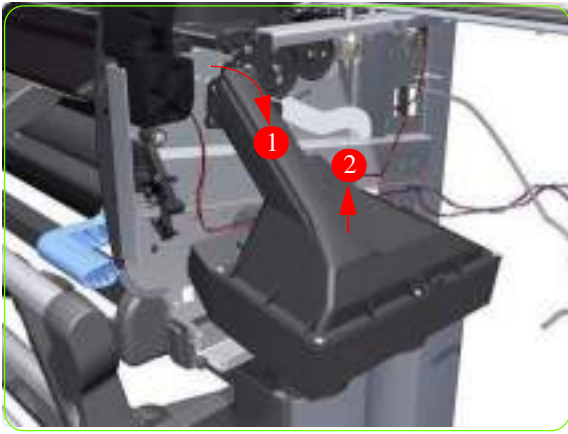

13. Lower then lift the Vacuum Fan out of its attachment.

14. Remove the Vacuum Fan from the Printer.



NOTE: When connecting the Vacuum Fan cables to the Interconnect PCA, make sure you connect the cable with the label marked Vacuum Fan 1 to connector 1 and the cable with the label marked Vacuum Fan 2 to connector 2. You can verify if both cables are labelled correctly by the actual markings on the Vacuum Fan.

NOTE: Make sure that the OMAS ribbon cable is free of slack when you install the cable clamp.

NOTE: After installing the NEW Vacuum Fan, make sure you perform the following Service Calibration:

- "5.3.4 Vacuum Calibration" ⇒ page 212
- Reset "4.3.4 Reset Vacuum Fan cycle" ⇒ page 200.

Aerosol Fan and Filter

Removal



WARNING! Switch off the printer and remove the power cable.

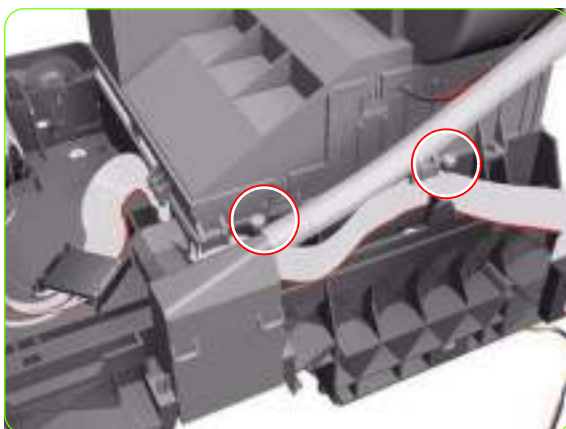
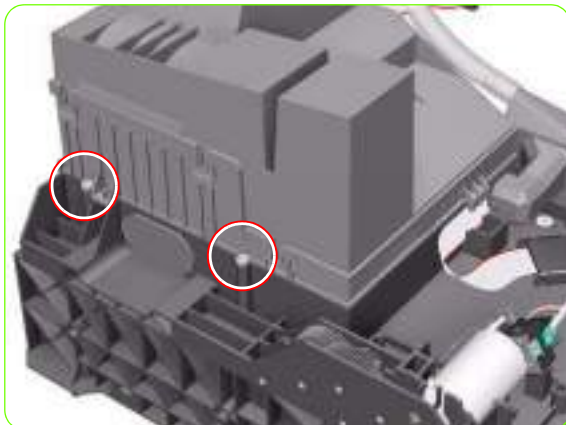

1. Remove the Right Cover ⇒ See page 319.
2. Remove the Rear Cover ⇒ See page 332.
3. Remove the Right Connector Cover ⇒ See page 341.
4. Remove the Service Station ⇒ See page 364
5. From underneath the Service Station: Remove two T-15 screws (**Type G**) that secure the Aerosol Fan to the Service Station.
6. From underneath the Service Station: Remove two T-15 screws (**Type G**) that secure the Aerosol Fan to the Service Station.

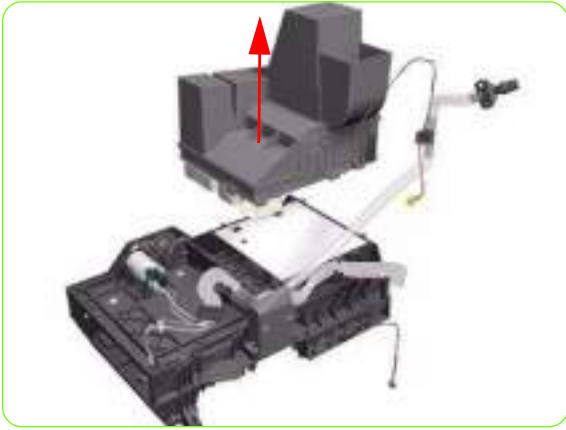

7. Remove the Aerosol Fan from the Service Station.

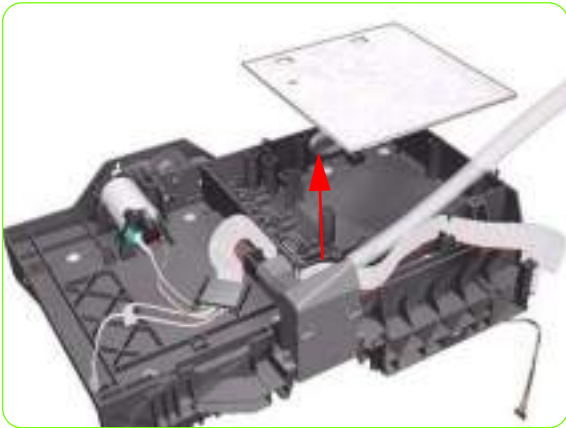

8. If necessary, remove the Aerosol Fan Filter from the Service Station.



9. Unlatch the Waste Ink Tube System from the Service Station.



10. Remove the Waste Ink Tube System.

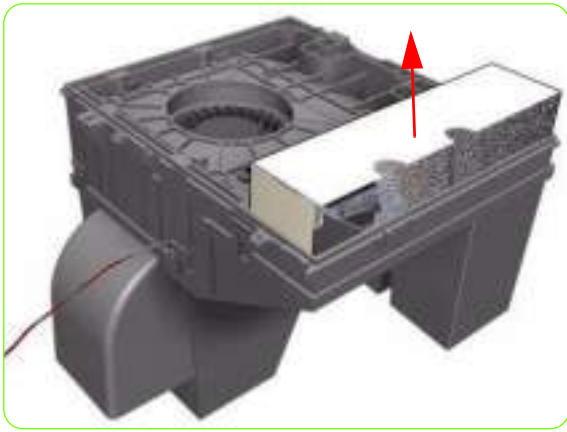

Installation

11. Remove the Foam Filter from the Vacuum Fan Assembly.

1. Reset the "4.7.1 Aerosol Fan and Filter cycle"
⇒page 201.

Waste Ink Tube

Removal



WARNING!: Switch off the printer and remove the power cable.

1. Remove the Right Cover ⇒ See page 319.
2. Remove the Right Connector Cover ⇒ See page 341.
3. Remove the Primer Assembly ⇒ See page 355.
4. Remove the Primer Valves ⇒ See page 357.
5. Remove the Printhead Maintenance Cartridge ⇒ See the User's Guide.
6. Remove the Service Station ⇒ See page 364.
7. Remove the Drop Detector ⇒ See page 377.
8. Remove two T-8 screws that secures the top of the Drain Tube to the Service Station (long screw driver or wrench key required).



9. Slide off the Drain Tube from the Service Station.

Drop Detector

Removal



WARNING! Switch off the printer and remove the power cable.



1. Remove the Right Cover ⇒ See page 319.
2. Disconnect the Drop Detector Cable from the Service Station Cable.
3. Release the Drop Detector Cable from the Service Station.
4. Pull out the Printhead Cleaning Cartridge fully from the Service Station to release the Carriage Assembly.



5. Lift the Primer and hold the Primer to its maximum position to avoid damaging it when you move the Carriage Assembly in the next step.



6. Slide the Carriage Assembly into the print path so you access the Drop Detector.

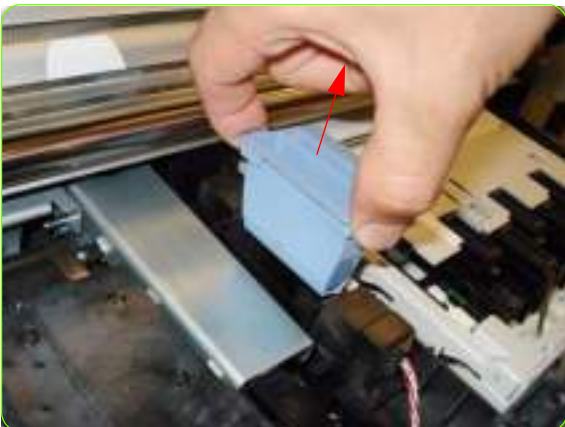

7. Remove the Ink Funnel.



8. Remove one T-8 screw (**Type K**) that secures the Drop Detector to the Service Station.



9. Slide the Drop Detector forward so you can release it from the Service Station.

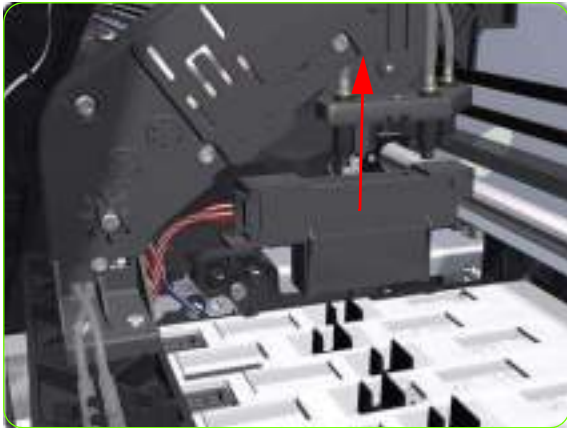

10. Remove the Drop Detector from the Printer.



NOTE: After installing a new Drop Detector, perform the following:

- "5.5.2 Drop Detector Calibration" ⇒ page 216.
 - Reset "4.7.4 Drop detector cycle" ⇒ page 201.
-

Ink Supply Tubes and Trailing Cable

Removal



WARNING!: Switch off the printer and remove the power cable.



CAUTION: You MUST NEVER replace both the Hard Disk Drive and the Ink Supply Tubes and Trailing Cable at the same time. If both parts need to be replaced, you MUST first replace one part and then power ON the Printer until it completely initializes. Then you can power OFF the Printer and replace the other part.

1. Remove the Right Cover ⇒ See page 319.
2. Remove the Left Cover ⇒ See page 325.
3. Remove the Top Cover ⇒ See page 334.
4. Remove the Rear Cover ⇒ See page 332.
5. Remove the Right Connector Cover ⇒ See page 341.
6. Remove the Ink supplies
7. Disconnect the Trailing Cable from the Interconnect PCA and the Sausalito PCI.



8. Release the Trailing Cable from the cable clamp.

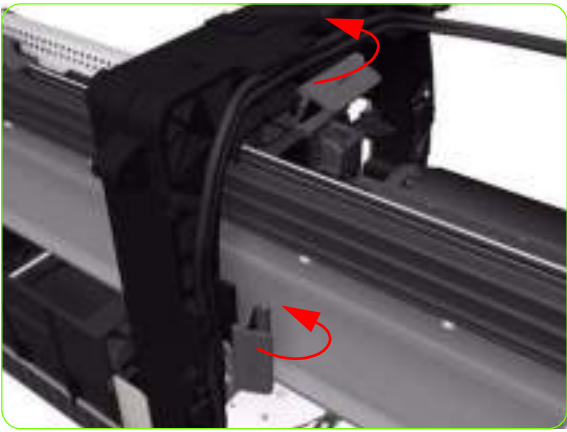

9. Release the two plastic clips securing the Trailing Cable to the Right Arc.



10. Press the two side of the Carriage PCA Cover and unclip from the Carriage Assembly.



11. Disconnect the Trailing Cable from the Carriage PCA.



12. Open the Carriage Cover and remove ALL the Printheads from the Carriage Assembly.

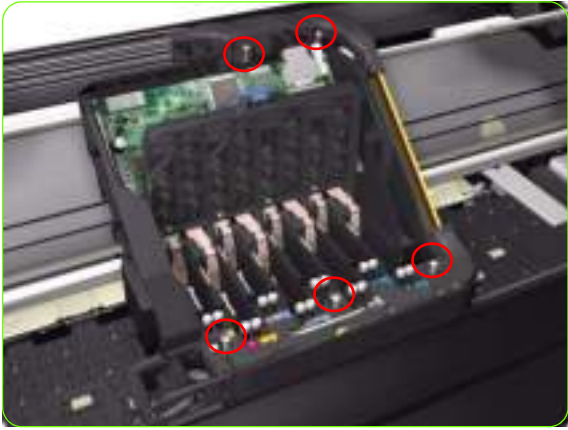

13. Remove five T-15 screws (**Type G**) that secure the Ink Supply Tubes to the Carriage Assembly.

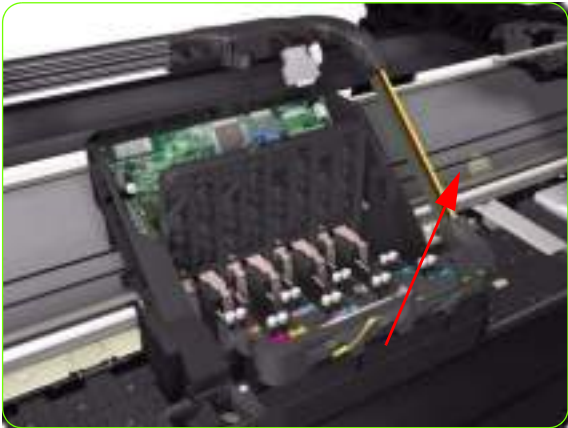

14. Remove the Ink Supply Tubes from the Carriage Assembly and safely place to one side of the Printer.

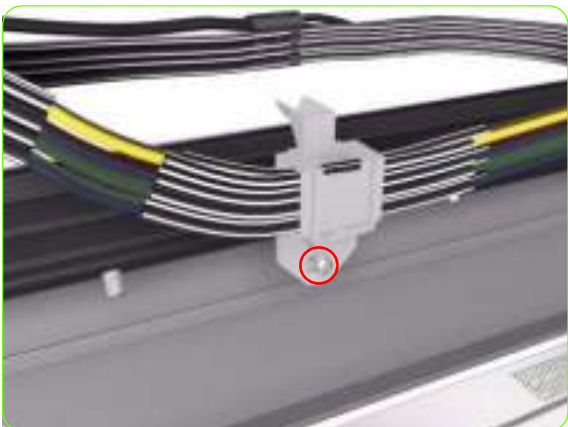

15. Remove one T-20 screw (**Type B**) from each plastic holder at the rear of the Printer.

16. Remove one T-15 screw that attaches the bonding cable to the printer chassis.

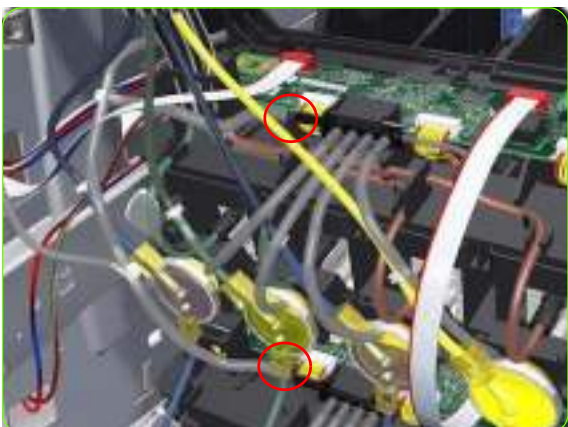

17. Disconnect the Air Tubes from the Ink Cartridge Tube Connector.

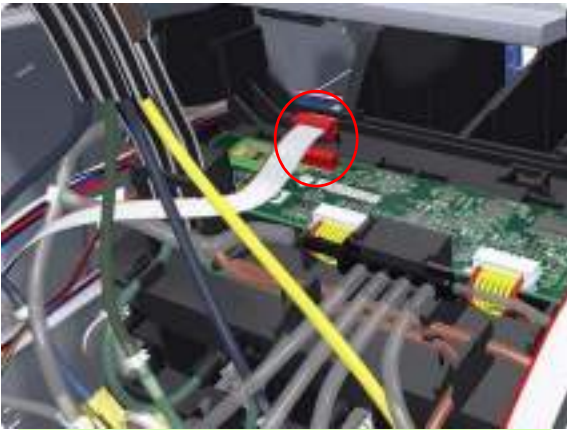

18. Disconnect the Electrical Cable from the rear of the Ink Cartridge Tube Connector.

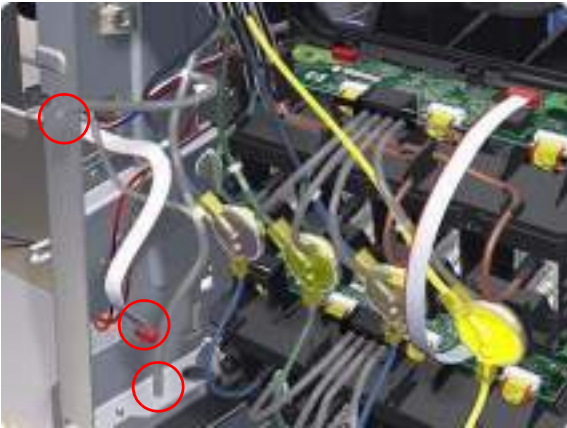

19. Unroute the Electrical Cable and Air Tubes from the rear of the Ink Cartridge Tube Connector.



20. Twist the four latches at the rear of the Ink Cartridge Tube Connector and release the complete assembly.



NOTE: Be careful not to damage the inter-connecting cable.



21. Carefully slide the Ink Cartridge Tube Connector off the Ink Supply Station.

22. Remove the Ink Supply Tubes and Trailing Cable from the Printer.

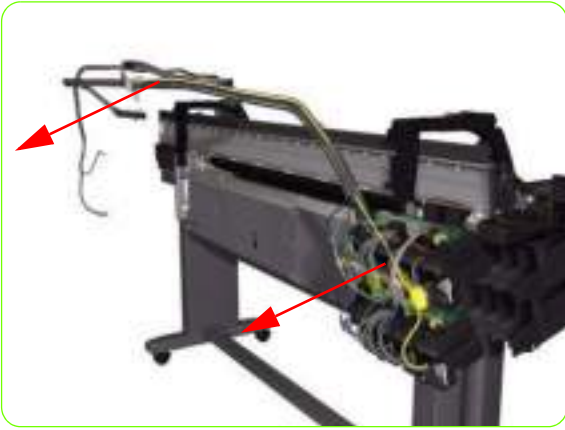

Installation of the Ink Supply Tubes and Trailing Cable



NOTE: After installing the NEW Ink Supply Tubes and Trailing Cable, reset the life counter "4.5.2 Tubes/Trailing Cable" ⇒ page 200.



NOTE: When installing the Ink Supply Tubes and Trailing Cable on to the Top Cover, take note of the of the two red marks on the Ink Supply Tubes. These two red marks should be aligned with the first slot in the Top Cover as this will help with the rest of the installation.

ISS to Cartridge Cables

Removal



WARNING! Switch off the printer and remove the power cable.

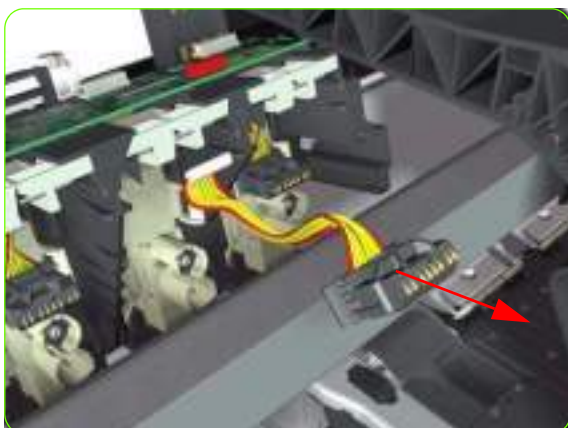
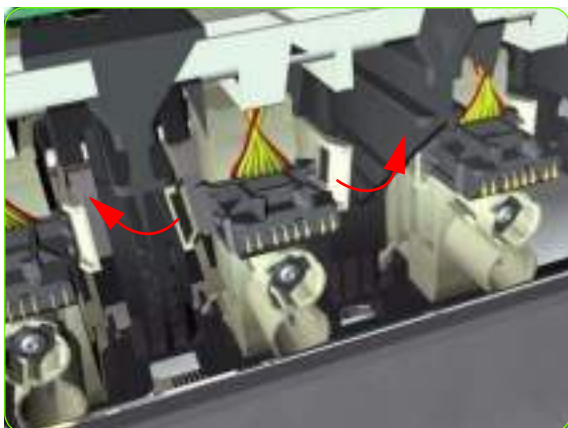
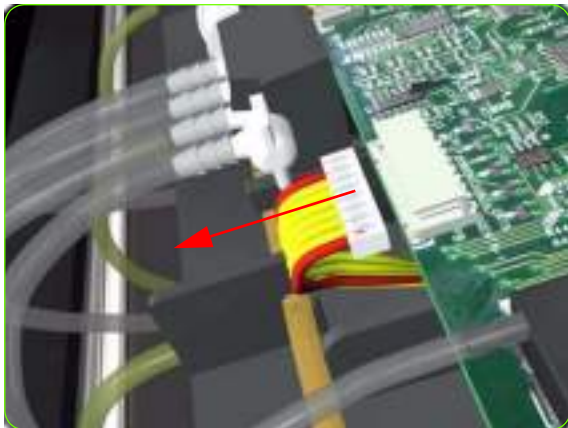

1. Remove the Left Cover ⇒ See page 325.
2. Disconnect the ISS to Cartridge Cable from the ISS PCA.
3. Release the clips securing the ISS to Cartridge Cable.
4. Remove the ISS to Cartridge Cable from the Printer.

Removal & Installation

Cutter Assembly

Removal

1. Select "Replace Cutter" from Service Menu (refer to Chapter 4) and follow the instructions on the Front Panel.
2. Open the Window.



3. Open the Carriage Cover.



4. Remove one T-15 screw (**Type G**) that secures the Cutter Assembly to the Carriage Assembly.





5. Slide the Cutter Assembly to the left and remove from the Printer.



NOTE: After installing the NEW cutter, reset the life counter "4.6.4 cutter cycles" ⇒ page 200.

Ink Supply Station (ISS)

Removal



WARNING!: Switch off the printer and remove the power cable.

1. Remove the Left Cover ⇒ See page 325.
2. Remove the Scan-Axis Motor ⇒ See page 419.
3. Pull out the top row of Cartridge Trays and remove the Ink Cartridges.

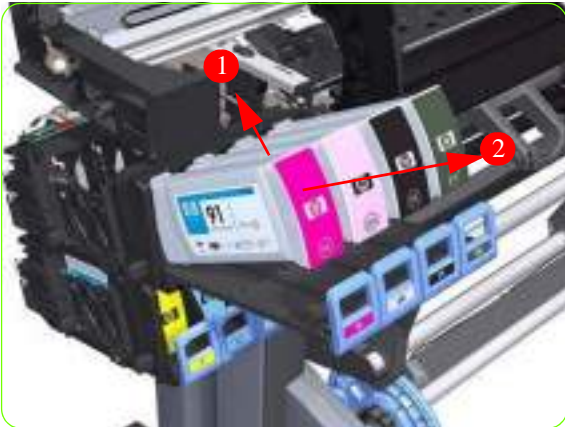

4. Close the top row of Cartridge Trays and pull out the bottom row.



5. Pull out the bottom row of Cartridge Trays and remove the Ink Cartridges.

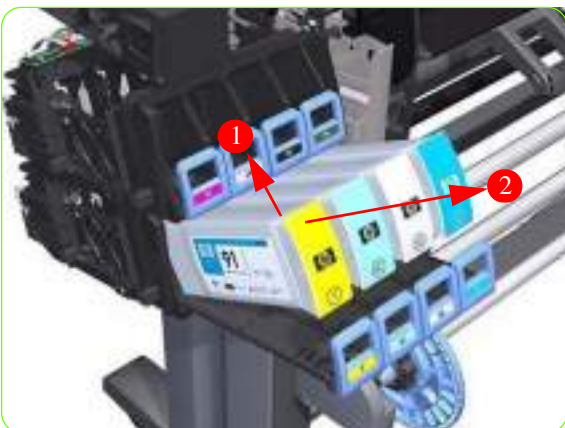

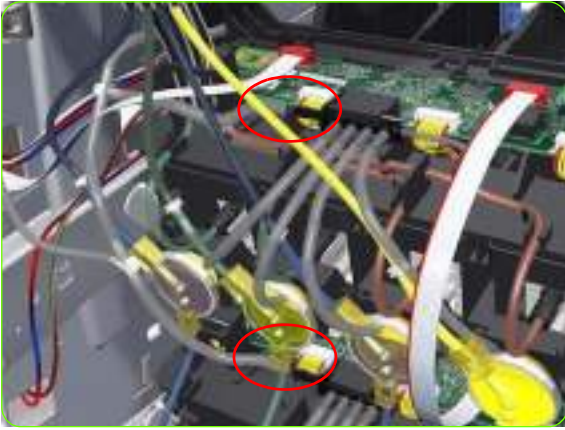

6. Disconnect the top and bottom Air Tubes from the Ink Supply Tubes.

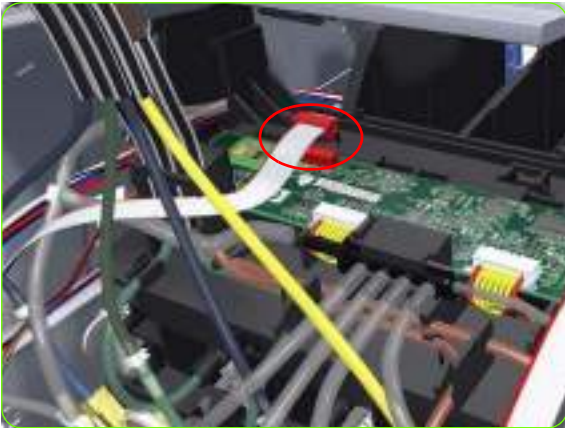

7. Disconnect the Electrical Cable from the rear of the Ink Cartridge Tube Connector.

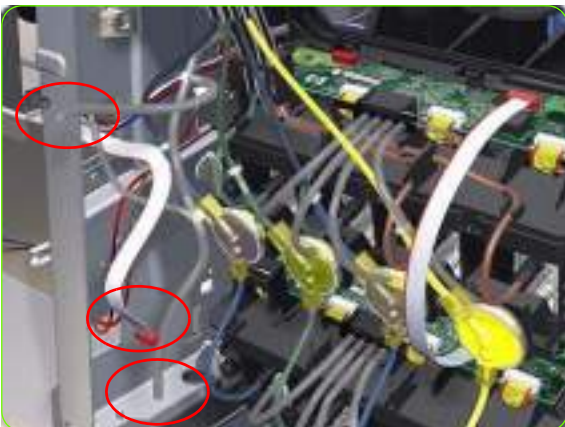

8. Unroute the Air Tubes and Electrical Connector.

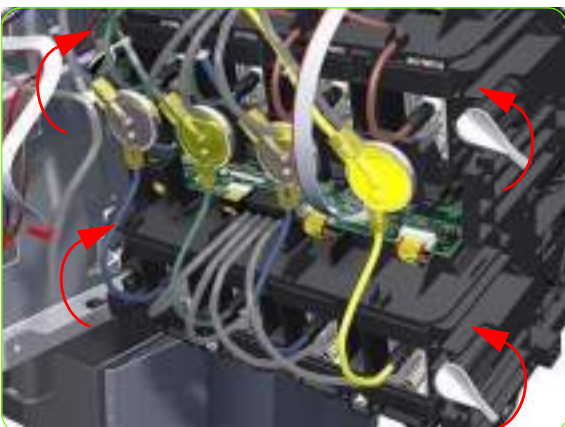

9. Twist the four latches at the rear of the lower Ink Cartridge Tube Connector and release the complete assembly.

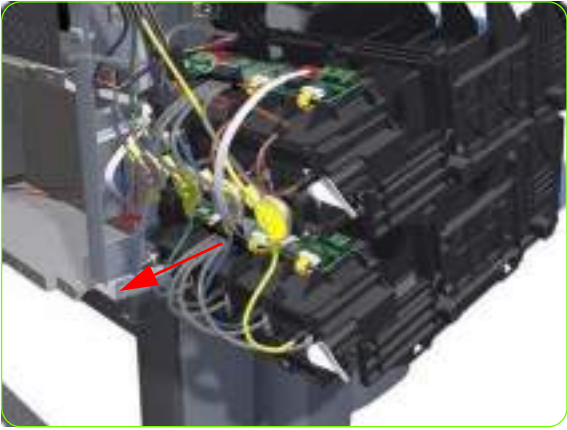

10. Lift the Cartridge Tube Connector off the Ink Supply Station.

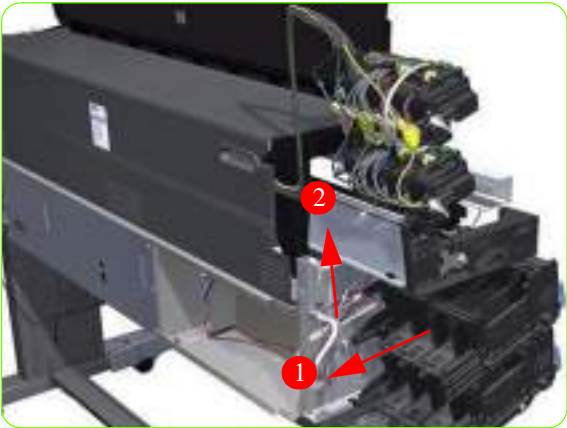

11. Remove the Cartridge Tube Connector from the Ink Supply Station.

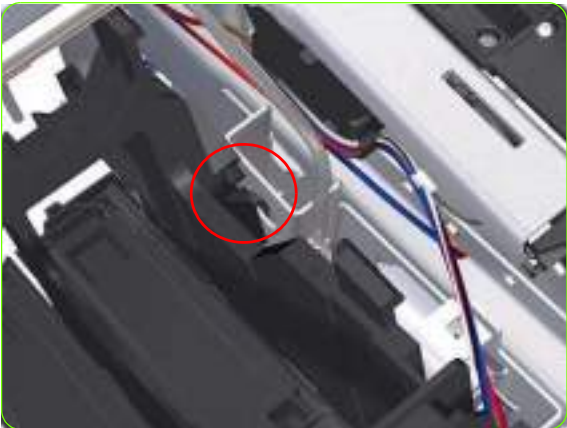

12. Unhook Ink Supply Station cables from the printer.

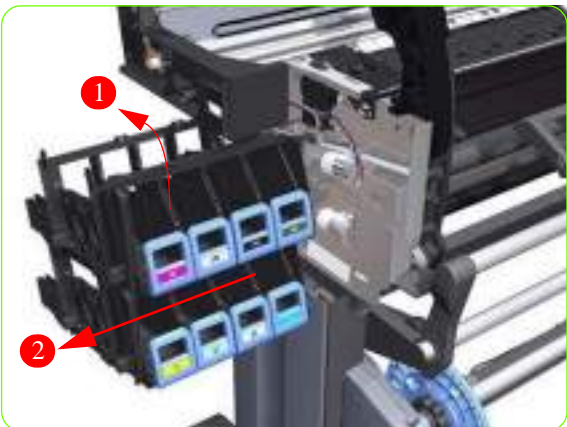

13. Remove the complete Ink Supply Station (upper and lower assemblies) from the Printer.

Ink Supply Station PCAs (Upper and Lower)

Removal



WARNING!: Switch off the printer and remove the power cable.



NOTE: You MUST NEVER replace both the Hard Disk Drive and the Ink Supply PCAs at the same time. If both parts need to be replaced, you MUST first replace one part and then power ON the Printer until it completely initializes. Then you can power OFF the Printer and replace the other part.

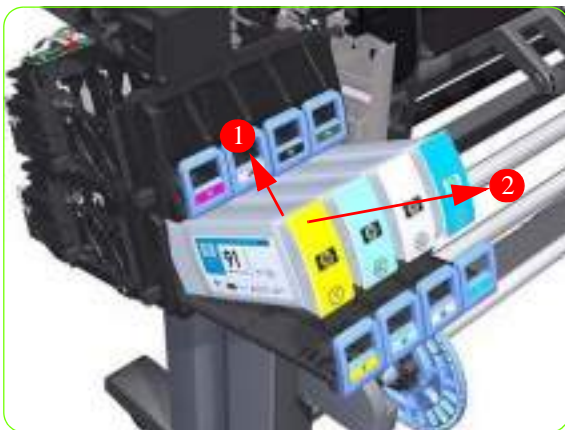
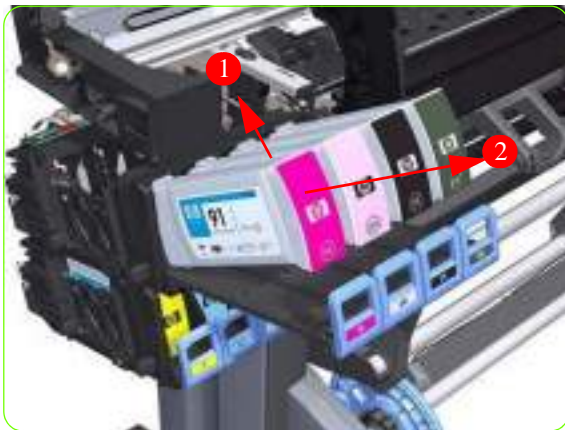

1. Remove the Left Cover ⇒ See page 325.
2. Pull out the top row of Cartridge Trays and remove the Ink Cartridges.
3. Close the top row of Cartridge Trays and pull out the bottom row.
4. Pull out the bottom row of Cartridge Trays and remove the Ink Cartridges.

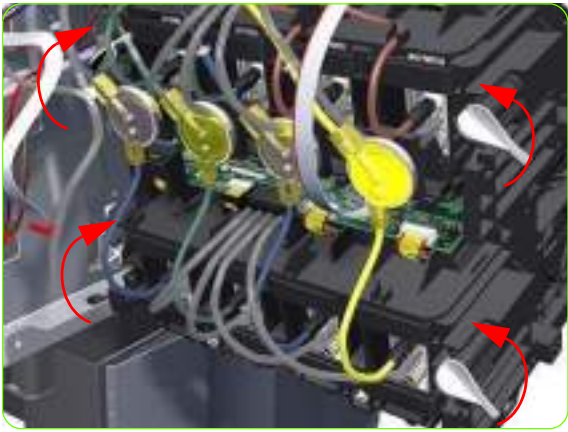

5. Twist the four latches at the rear of the lower Ink Cartridge Tube Connector and release the complete assembly.

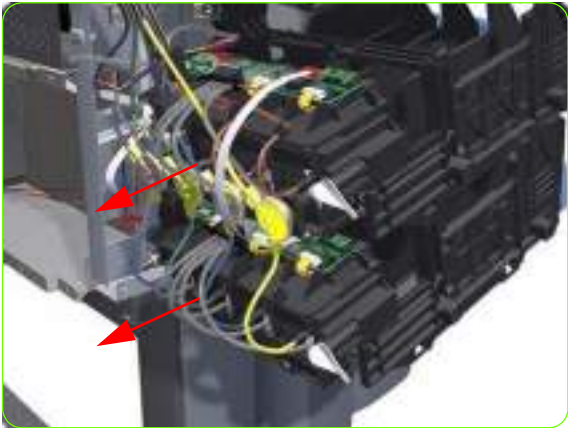

6. Slide the Upper and Lower Cartridge Tube Connectors out of the ISS Assembly (but do not remove) to gain access to the Upper ISS PCAs.



7. Disconnect the Air Tube from the Upper ISS PCA.



8. Disconnect the Electrical Cable from the Upper ISS PCA.

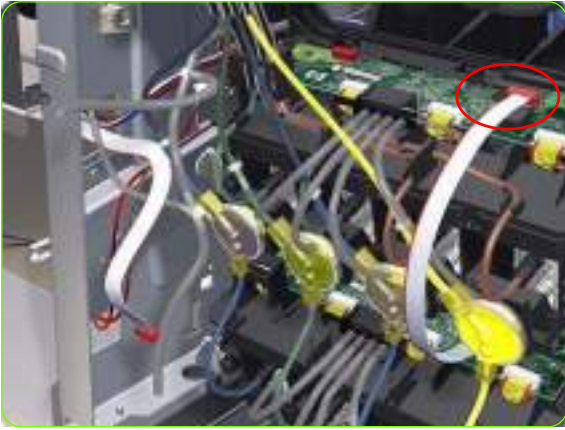

9. Disconnect the Electrical Cable from the Upper ISS PCA.

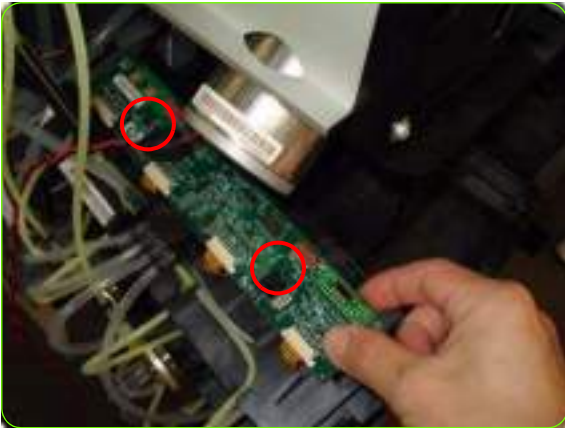

10. Remove two T-10 screws from the Upper ISS PCA.

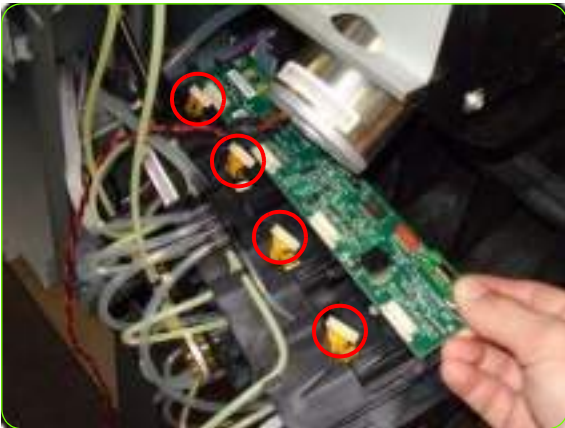

11. Disconnect four connectors from the Upper ISS PCA.

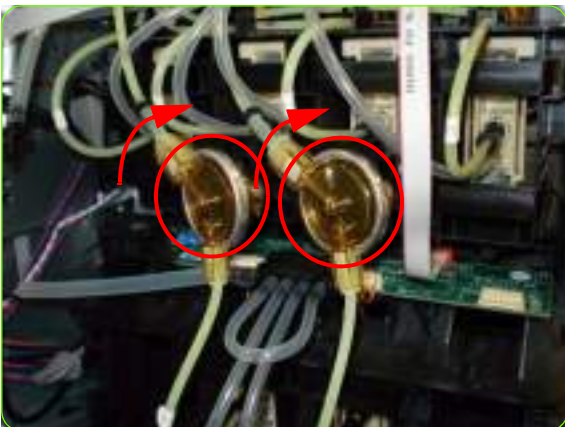

12. Tip: To make the removal easier you can remove the two Ink Valves located at the rear of the Upper Cartridge Tube Connector from holders, by turning them in a clockwise direction.

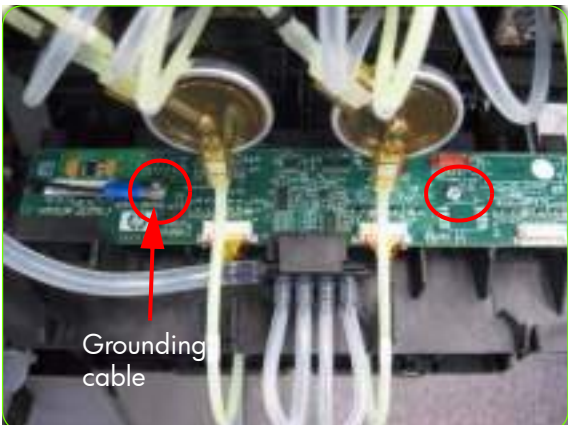

13. Slide out the Lower Carriage Tube Connector to gain access to the Lower ISS PCA (but do not remove). You may need to slide in the Upper Carriage Tube Connector.

14. Disconnect the Electrical Cable from the Lower ISS PCA.

15. Remove two T-10 screws from the Lower ISS PCA (one screw also secures a grounding cable).

16. Disconnect the two Electrical Cables from the Lower ISS PCA.

APS Assembly

Removal



WARNING! Switch off the printer and remove the power cable.

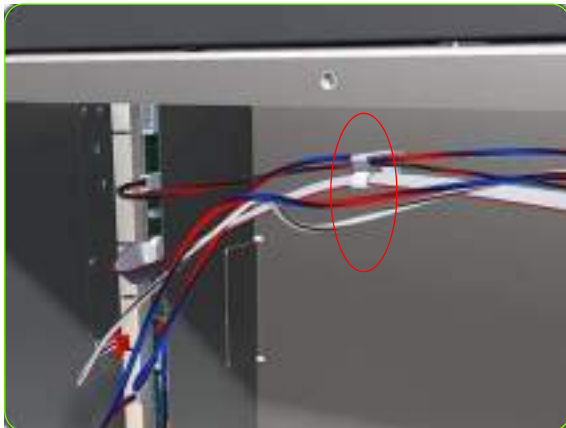
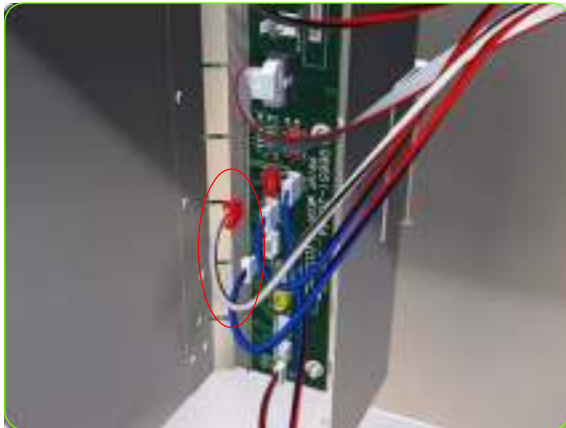

1. Remove the Left Cover ⇒ See page 319.
2. Remove:
 - The Left Connector Cover or the 42-inch model ⇒ See page 343.
 - The Electronics Module Extension the 60-inch model ⇒ See page 344.
3. Remove the Scan-Axis Motor ⇒ See page 419.
4. Remove the ISS ⇒ See page 388.
5. Disconnect the APS 1 (Top unit) valve electrical connectors from the PCA.
6. Unclip the APS 1 electrical cables from the cable clamps in the left connector panel

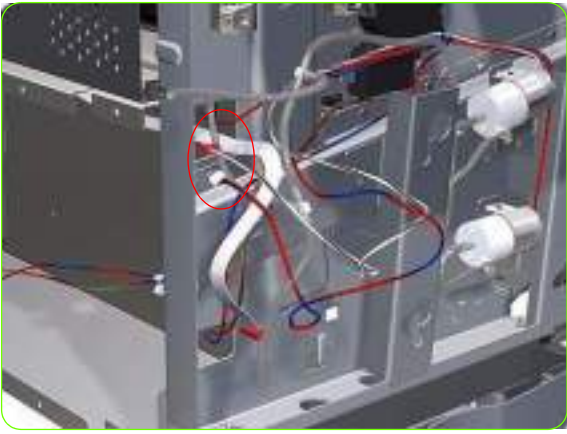

7. Unroute the APS 1 electrical connections from the left connector panel.

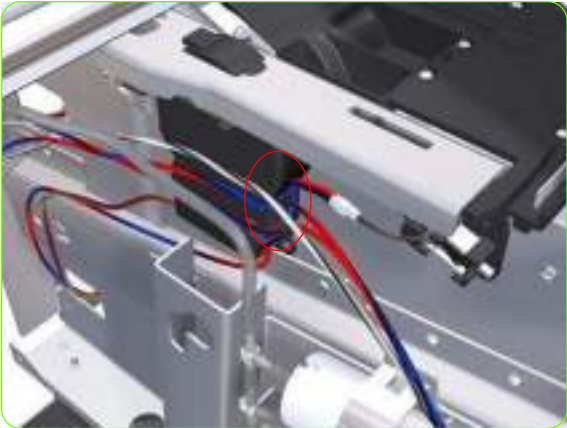

8. Unroute the electrical connections from the printer.

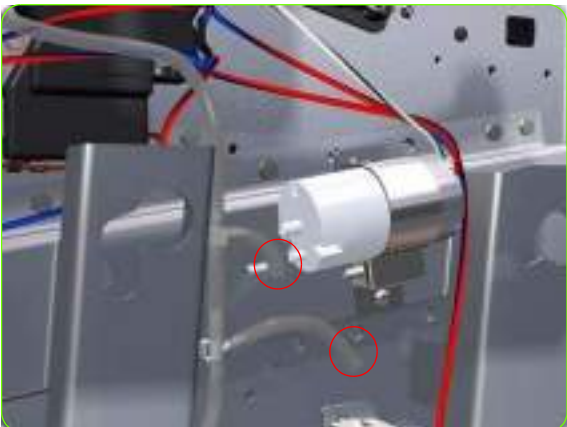

9. Disconnect both air tubes from APS 1.

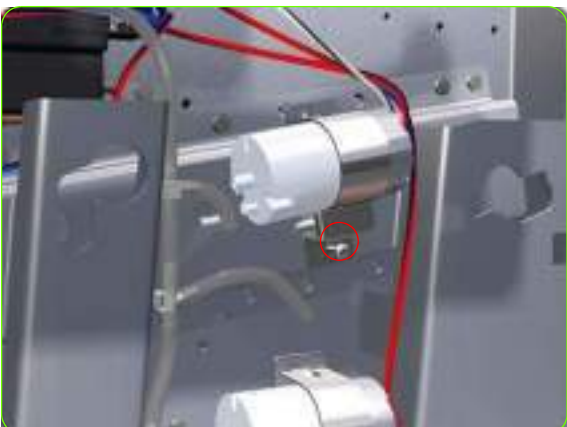

10. Remove one T-20 attachment screw from APS 1 (Top unit).

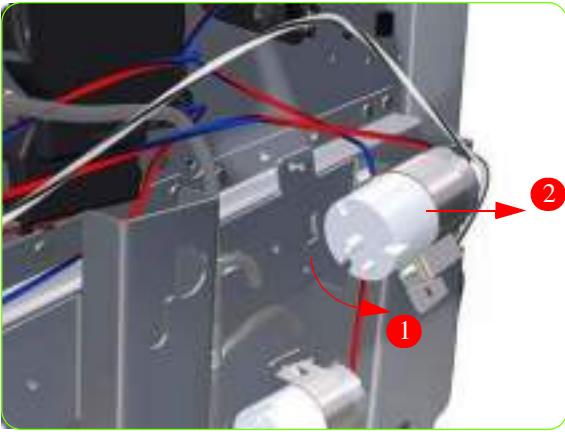

11. Remove APS 1 (Top unit) from the printer.

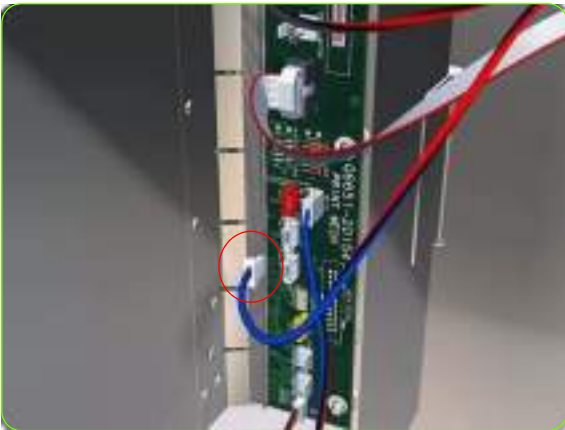

12. Remove the ISS ⇒ See page 388.

13. Disconnect the APS 2 (Top unit) valve electrical connectors from the PCA.

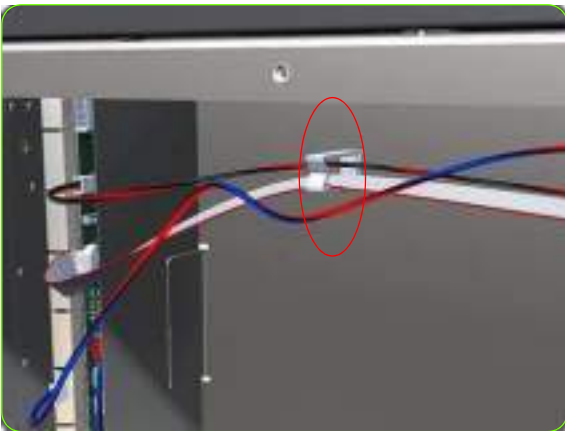

14. Unclip the APS 2 electrical cable from the cable clamps in the left connector panel

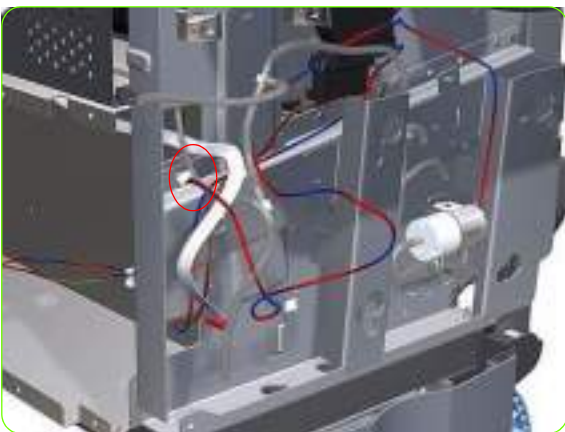

15. Unroute the APS 2 electrical connection from the Media Path Cover Encoder.

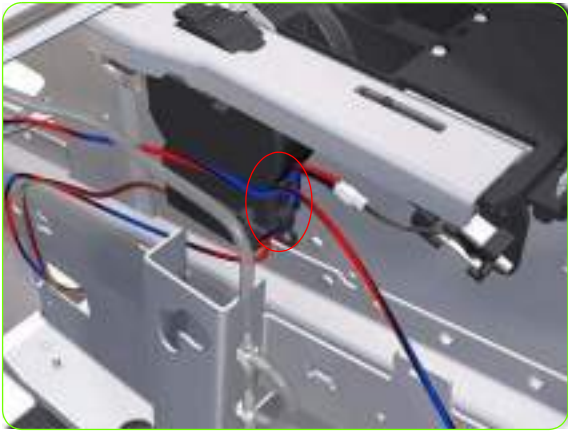

16. Unroute the APS 2 electrical connection from the printer.



17. Disconnect both air tubes from APS 2.



18. Remove one T-20 attachment screw from APS 1 (Top unit).

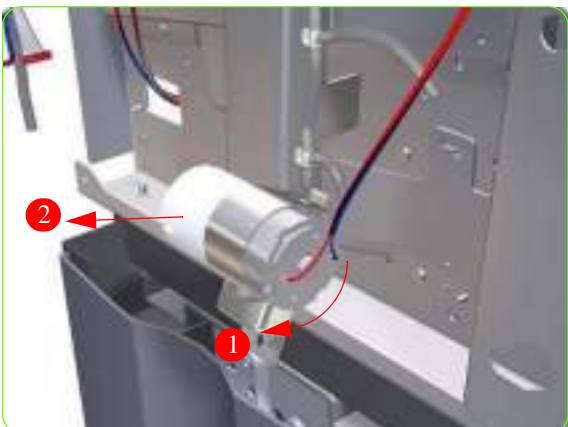

19. Remove APS 2 (Bottom unit) from the printer.



NOTE: After installing the NEW APS pumps, reset the life counter "4.4.1 APS cycles" ⇒ page 200.

Encoder Strip and Encoder Sensor

Removal



WARNING! Switch off the printer and remove the power cable.

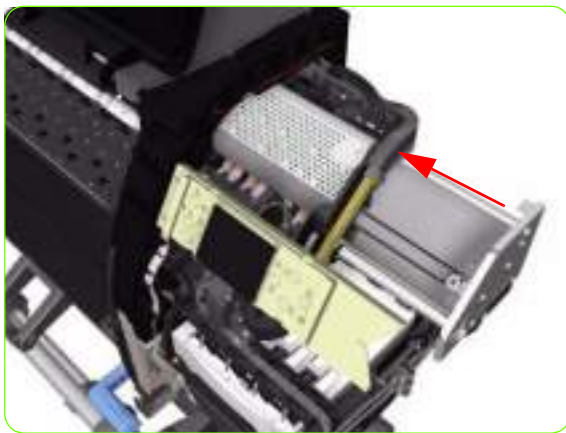

1. Remove the Right Cover ⇒ See page 319.
2. Remove the Left Cover ⇒ See page 325.
3. Uncap the Carriage Assembly by manually pulling out the Printhead Maintenance Cartridge tray.
4. Lift the Primer and hold the Primer to its maximum position to avoid damaging it when you move the Carriage Assembly in the next step.
5. Move the Carriage Assembly out of the Service Station.



6. Remove one T-10 screw (**Type I**) that secures the Encoder Strip on the right hand side of the Printer.



7. Release the Encoder Strip from the locating pins on the right hand side of the Printer.

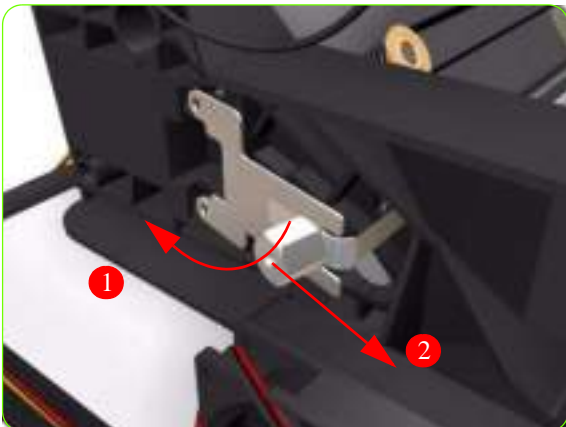

8. Release the Spring Clip from the Bracket on the left hand side of the Printer.

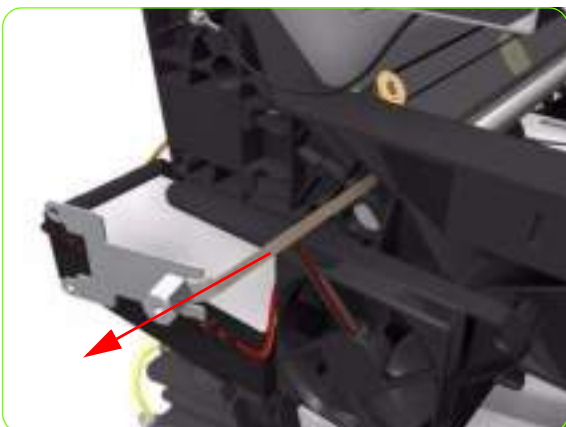

9. Carefully pull the Encoder Strip out of the left hand side of the Printer.
10. Remove the Carriage PCA ⇒ See page 402.

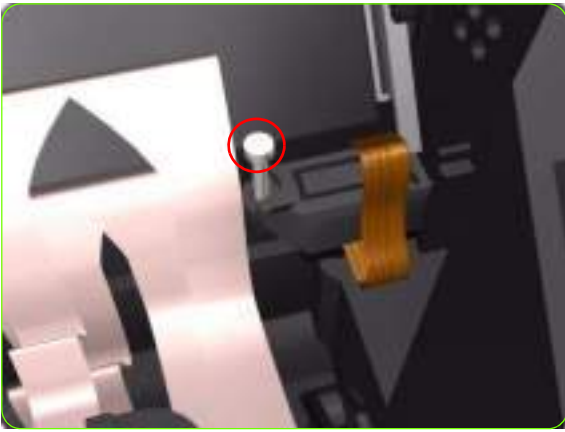

11. Remove one T-8 (**Type L**) screw that secures the Encoder Sensor to the Carriage Assembly.



12. Remove the plastic cover from the Encoder Sensor.

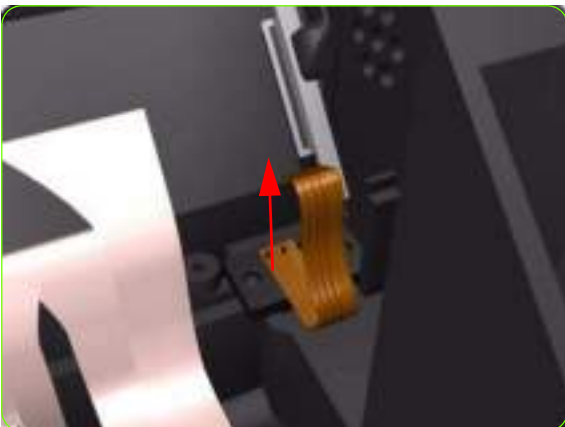

13. Remove the Encoder Sensor from the Printer.



NOTE: After installing the NEW Encoder Strip and Encoder Sensor, perform the following Service Calibration:

- "5.5.1 Scan Axis Calibration" ⇒ page 213.
- Reset the life counter "4.5.4 Encoder Strip cycles" ⇒ page 200.

Carriage PCA

Removal



WARNING!: Switch off the printer and remove the power cable.

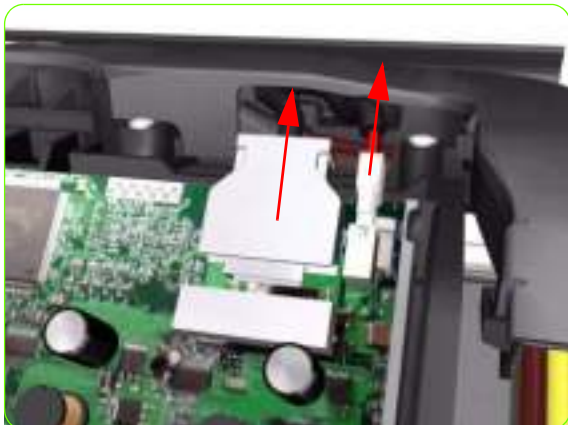
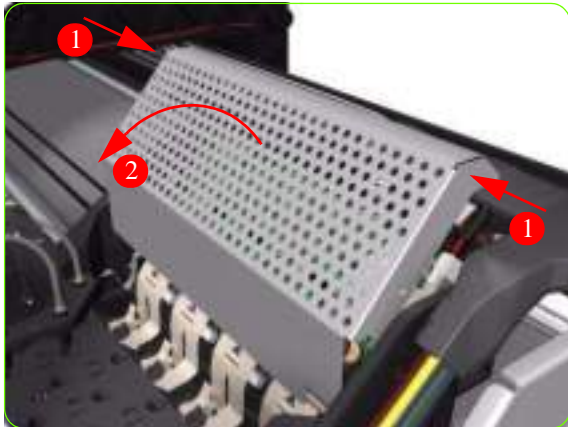

1. Remove the Right Cover ⇒ See page 319.
2. Press the two side of the Carriage PCA Cover and unclip from the Carriage Assembly.
3. Disconnect the Trailing Cable from the Carriage PCA.
4. Use a flat bladed screwdriver to release the ALL the clips, securing the Carriage Flex Cables to the Carriage Assembly, by pulling upwards.



5. Disconnect the Flex Cables from the Carriage PCA.

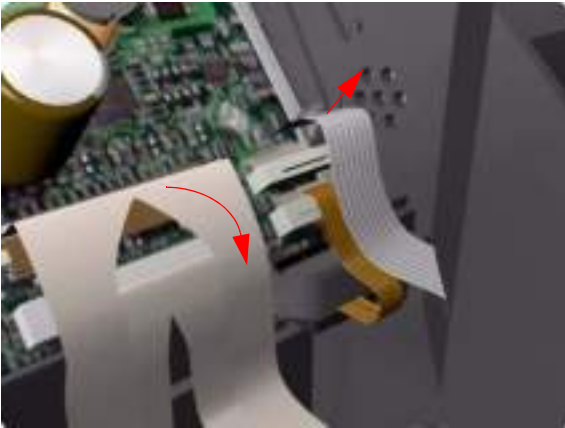

6. Disconnect the Line Sensor Cable and the Encoder Sensor Cable from the Carriage PCA.

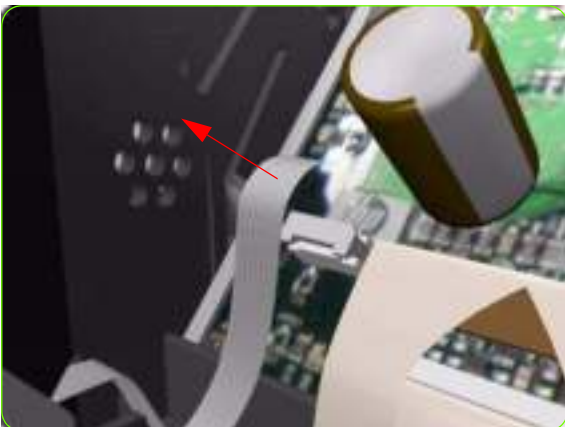

7. Disconnect the Color Sensor Cable from the Carriage PCA.



8. Push inwards the four clips that secure the Carriage PCA.



9. Remove the Carriage PCA from the Printer.

Carriage Flex Cables

Removal



WARNING! Switch off the printer and remove the power cable.

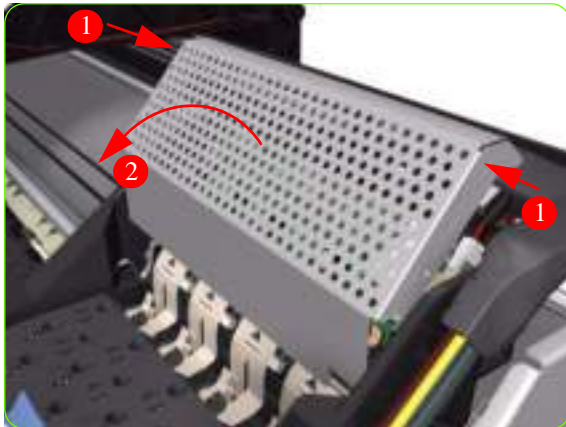

1. Remove the Right Cover ⇒ See page 319.
2. Remove the Front Panel ⇒ See page 353.
3. Remove the Primer Assembly ⇒ See page 355.
4. Press the two side of the Carriage PCA Cover and unclip from the Carriage Assembly.
5. Use a flat bladed screwdriver to release the ALL the clips, securing the Carriage Flex Cables to the Carriage Assembly, by pulling upwards.
6. Disconnect the ALL the Flex Cables from the Carriage PCA.

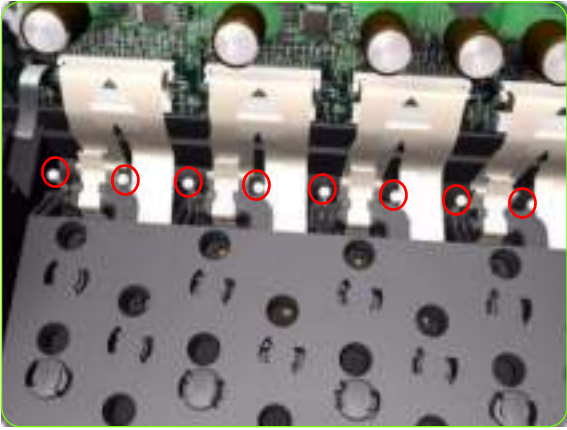

7. Remove eight T-8 screws (**Type L**) that secure the Carriage Flex Cables to the Carriage Assembly.



8. Open the Carriage Cover and remove ALL the Printheads from the Carriage Assembly.



9. The two unused spaces of the Carriage Assembly have dummy printheads installed. To remove them, insert a thin bladed tool into a small hole on the left to release them from a latch located underneath.



10. Remove the dummy Printheads.



11. Remove the Carriage Flex Cable from the Printer.

Carriage Assembly

Removal



WARNING!: Switch off the printer and remove the power cable.

1. Remove the Right Cover ⇒ See page 319.
2. Remove the Front Panel ⇒ See page 353.
3. Remove the Primer Assembly ⇒ See page 355.
4. Remove the Left Cover ⇒ See page 325.
5. Remove the Encoder Strip ⇒ See page 399.
6. Pull out the Printhead Maintenance Cartridge tray.



7. Lift the Primer and hold the Primer to its maximum position to avoid damaging it when you move the Carriage Assembly in the next step.



8. Move the Carriage Assembly to the extreme right of the Printer.

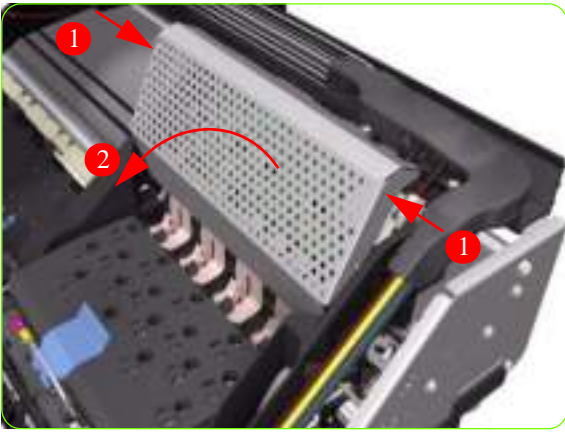

9. Press the two side of the Carriage PCA Cover and unclip from the Carriage Assembly.



10. Disconnect the Trailing Cable from the Carriage PCA.

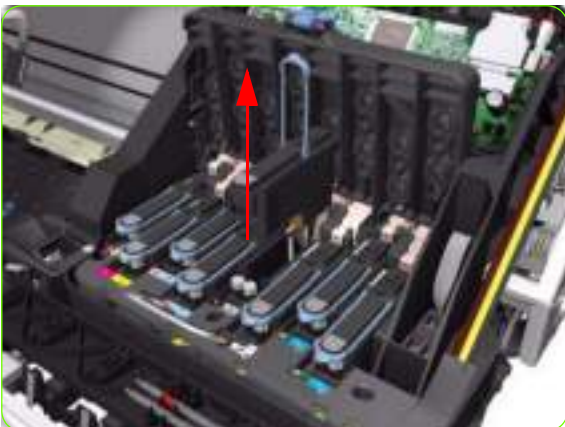

11. Open the Carriage Cover and remove ALL the Printheads from the Carriage Assembly.

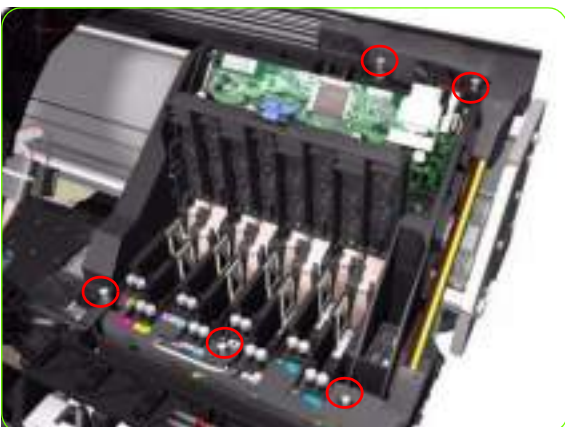

12. Remove five T-15 screws (**Type G**) that secure the Ink Supply Tubes to the Carriage Assembly.

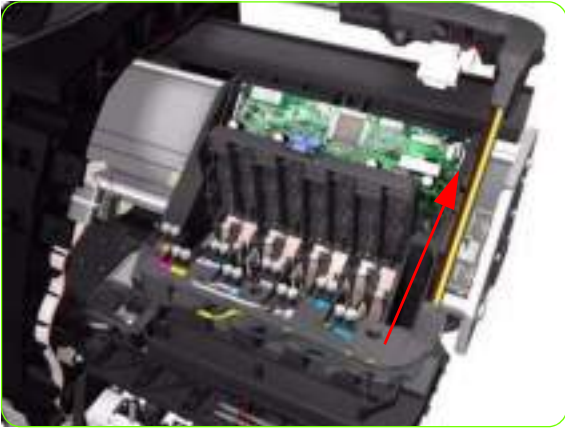

13. Remove the Ink Supply Tubes from the Carriage Assembly and safely place to one side of the Printer.



14. Remove one T-20 screw (**Type A**) that secures the Belt Tensioner to the Chassis.



15. Lift the Primer and hold the Primer to its maximum position to avoid damaging it when you move the Carriage Assembly in the next step.



16. Move the Carriage Assembly slightly away from the right Scan-Axis Bracket.



17. Release the Carriage Belt from the Scan-Axis Motor on the left hand side of the Printer.



18. Remove one T-10 screw (**Type C**) that secure the Encoder Strip.



19. Remove four T-20 screws (**Type N**) that secure the right Scan-Axis Bracket.



NOTE: Note that these are Chassis screws and in normal circumstances should NEVER be removed, but in this case we need to remove them in order to remove the Carriage Assembly.

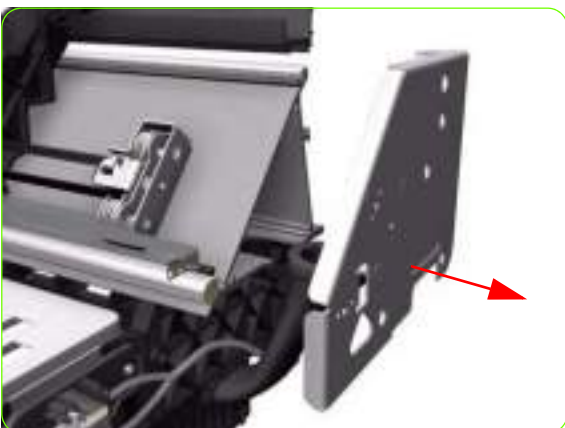

20. Remove the right Scan-Axis Bracket from the Printer.



21. Remove the Carriage Stopper Screw (T-20) from the Chassis.

22. Remove the Carriage Stopper from the Printer.

23. Slide the Carriage Assembly (including the belt) to the right and out of the Printer.

24. If the Carriage Assembly is to be replaced, make sure that you remove the Belt, the Carriage PCA, Color Sensor, Encoder and Line Sensors and the Cutter Assembly (in order to install them on the new Carriage Assembly).



NOTE: After installing the NEW Carriage Assembly, perform the following:

- "5.5.1 Scan-Axis Calibration" ⇒ See page 213.
- "5.6.1 Line Sensor Calibration" ⇒ See page 217.
- "5.6.2 Primer Calibration" ⇒ See page 220.
- "3.3 substrate Path Sensors" ⇒ See page 138.
- Reset the life counters for the following:
 - "4.6.1. Carriage cycles" ⇒ -200
 - "4.6.4 Cutter cycles" ⇒ -200
 - "4.6.6. Carriage lubrication" ⇒ -200

Media Jam Sensor, cable & Carriage Reflector Assembly

Removal



WARNING! Switch off the printer and remove the power cable.

1. Remove the Left Cover ⇒ page 325.
2. Remove the Rear Cover ⇒
3. Remove the Left Connector Cover:
 - For the 42-inch model ⇒ See page 343.
 - For the 60-inch model ⇒ See page 344.
4. Remove two T-15 screws from the Media Jam Sensor.



5. Remove the Media Jam Sensor Plate.



6. Remove the Media Jam Sensor from the clip on the Left Scan-Axis Bracket.



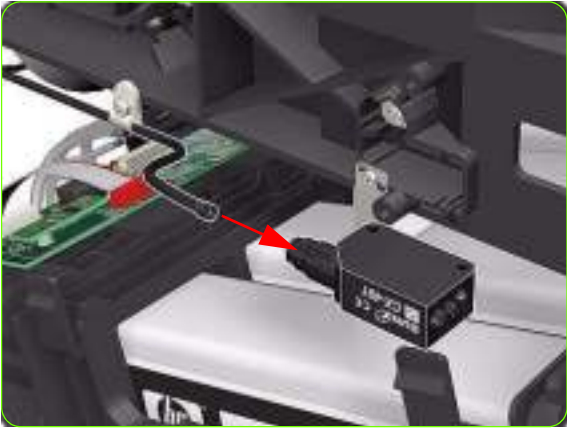

7. Disconnect the Media Jam Sensor from the cable.

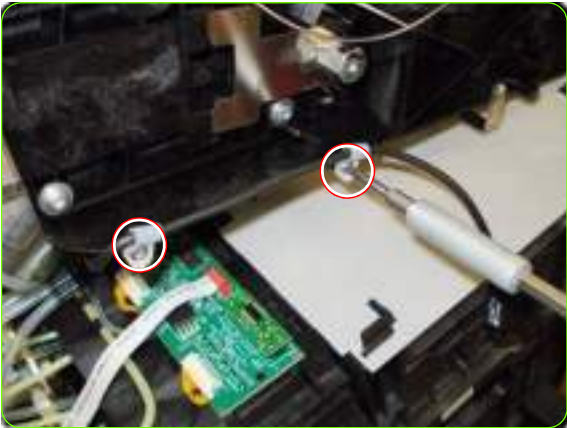

8. Remove two T-15 screws from cable clamps securing the cable of the Media Jam Sensor to the Left Scan-Axis bracket.



9. Unroute the cable of the Media Jam Sensor through the Service Station.



10. Push the cable of the Media Jam Sensor through a cavity in the chassis.

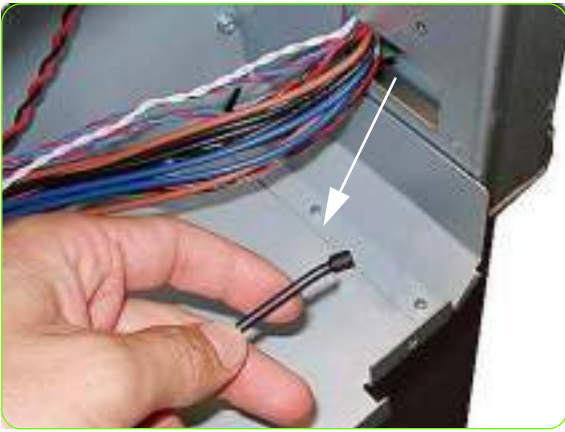

11. Pull the rest of the cable through the cavity in the chassis.



12. Release the cable of the Media Jam Sensor from the bundle of cables held with cable clamps (in the 60" Printer only).

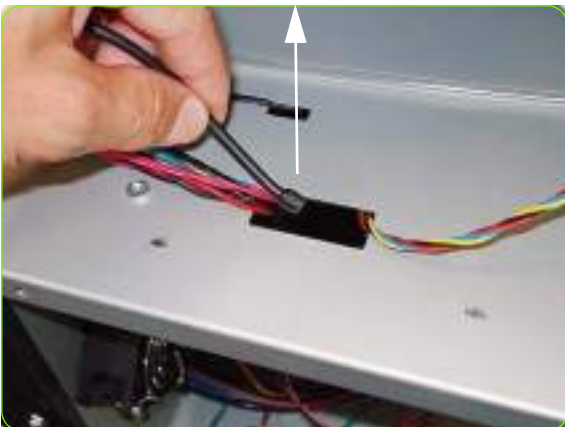

13. Pull the cable through the cavity at the top of the electronics enclosure.



14. Release the cable of the Media Jam Sensor from the bundle of cables held with cable clamps along the top of the Electronics Enclosure.

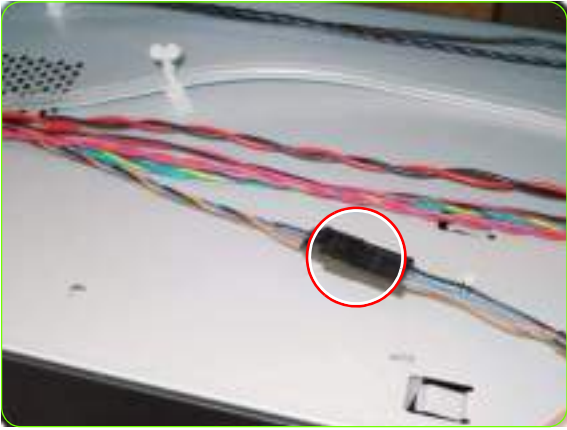

15. Disconnect the cable of the Media Jam Sensor from the cable on top of the Electronics Enclosure.



16. Open the Printhead Maintenance Cartridge Door.



17. Pull out the Printhead Maintenance Cartridge tray.



18. Slide the Carriage to the center of the platen.

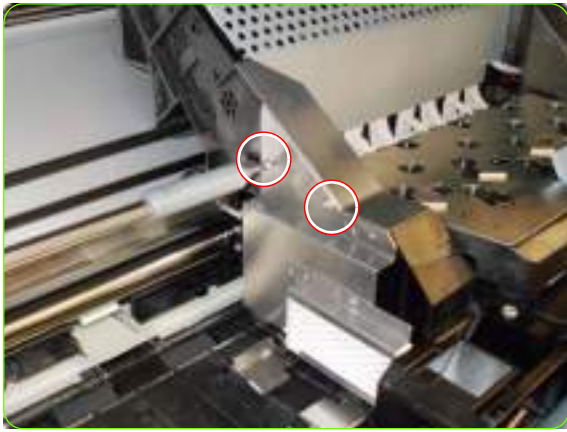

19. Remove two T-8 screws from the side of the Reflector Assembly.



20. Remove the Carriage Reflector Assembly.



NOTE: After installing the NEW Jam Sensor Assembly, perform the following to test the functionality:

- "3.7 Media Jam sensor test".

Belt Assembly

Removal



WARNING! Switch off the printer and remove the power cable.

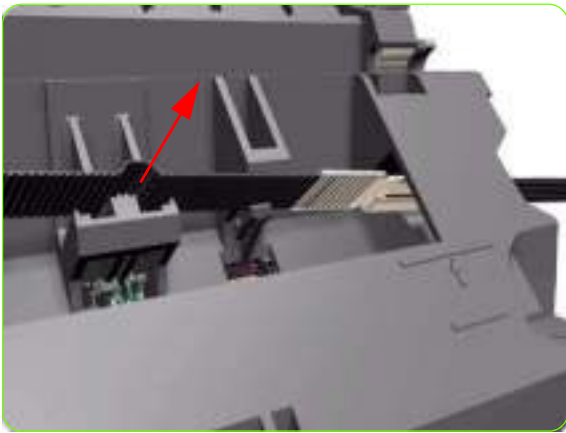

1. Remove the Right Cover ⇒ See page 319.
2. Remove the Left Cover ⇒ See page 325.
3. Remove the Top Cover ⇒ See page 334.
4. Remove the Encoder Strip ⇒ See page 399.
5. Remove the Carriage Assembly ⇒ See page 408.
6. Release the Belt from the bottom of the Carriage Assembly.



NOTE: After installing the NEW Belt Assembly, make sure you perform the following Service Utility:

- Reset the life counter "4.5.1 Reset belt cycles ⇒ See page 200.

Scan-Axis Motor

Removal



WARNING! Switch off the printer and remove the power cable.



1. Remove the Right Cover ⇒ See page 319.
2. Remove the Left Cover ⇒ See page 325.
3. Remove:
 - For the 42-inch model, the Left Connector Cover ⇒ See page 343.
 - For the 60-inch model, the Electronics Module Extension ⇒ See page 344.
4. Uncap the Carriage Assembly by manually pulling out the Printhead Maintenance Cartridge tray.
5. Lift the Primer and hold the Primer to its maximum position to avoid damaging it when you move the Carriage Assembly in the next step.

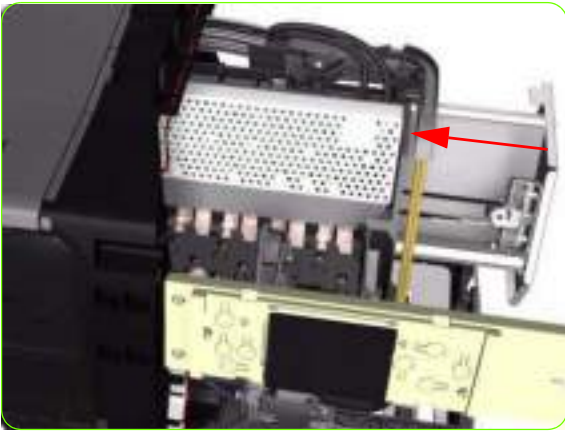

6. Move the Carriage Assembly slightly away from the right Scan-Axis Bracket.



7. Remove one T-15 screw that secures the Belt Tensioner to the Chassis.



8. Release the Carriage Belt from the Scan-Axis Motor on the left hand side of the Printer.



9. Disconnect the Scan-Axis Motor cable from the PrintMech PCA.

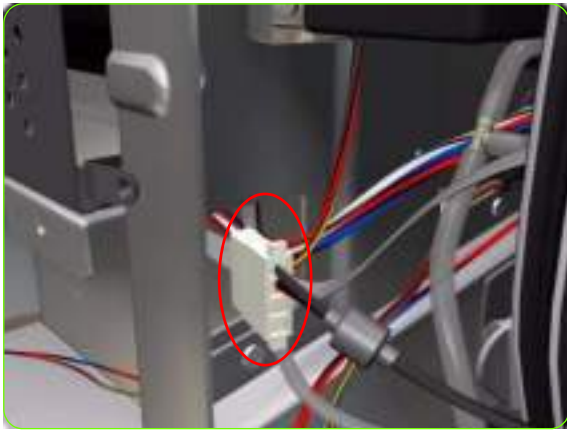

10. Unroute the Scan-Axis Motor cable from the chassis.



11. Remove two T-20 screws (**Type A**) that secure the Scan-Axis Motor.



NOTE: Make sure you hold the Scan-Axis Motor securely when removing the screws.

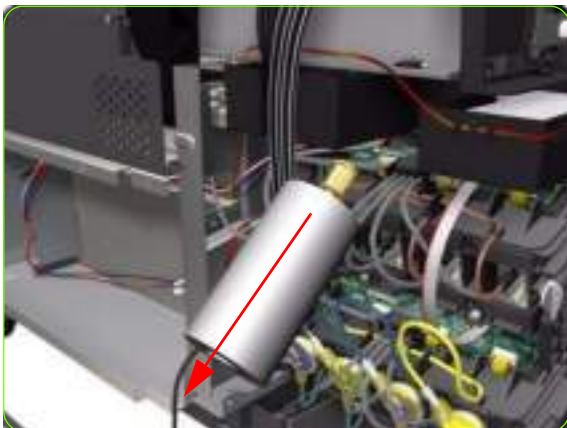

12. Remove the Scan-Axis Motor from the Printer.



NOTE: After installing the NEW Scan-Axis Motor, make sure you perform the following Service Utility:

- Reset the life counter "4.5.3 Scan Axis motor" ⇒ See page 200.

Media-Axis Motor

Removal



WARNING!: Switch off the printer and remove the power cable.

1. Remove the Left Cover ⇒ See page 325.
2. Remove the Rear Cover ⇒ See page 332.
3. Remove:
 - For the 42-inch model, the Left Connector Cover ⇒ See page 343.
 - For the 60-inch model, the Electronics Module Extension ⇒ See page 344.
4. Disconnect the Media-Axis Motor cable from the PrintMech PCA.



5. Detach the clamp of the ferrite core of the Media-Axis Motor cable from the printer chassis.

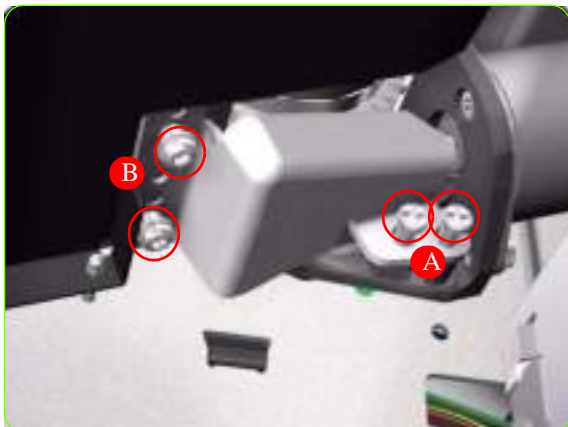

6. Remove the T-15 screws (**Type R**) identified (A) and loosen the T-15 screws (**Type R**) identified (B) that secure the Media-Axis Motor.

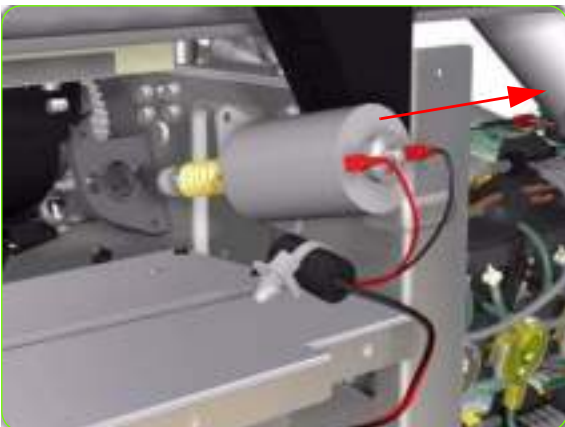
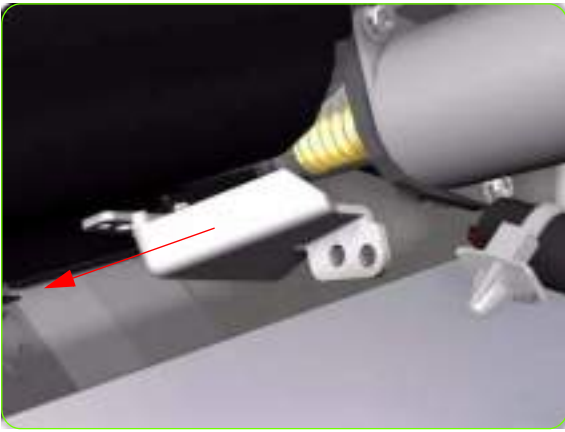

7. Remove the Media-Axis Motor Bracket.

8. Remove two T-20 screws (**Type B**) that secure the Media-Axis Motor Bracket.

9. Remove the Media-Axis Motor from the Printer.



NOTE: When reinstalling the parts, make sure you apply the grease (included with the support part) to the gears.

NOTE: After installing the NEW Media-Axis Motor, make sure you perform the following Service Calibration:

- "5.3.1 Paper Advance Calibration" ⇒ See page 201.
- "4.3.2 Drive Roller Motor" ⇒ See page 200.

Optical Media Advance Sensor (OMAS)

Removal



WARNING!: Switch off the printer and remove the power cable.

1. Remove the Left Cover ⇒ See page 325.
2. Remove the Right Cover ⇒ See page 319.
3. Remove the Rear Cover ⇒ See page 332.
4. Remove media if installed.
5. Remove one T-10 screw from the Media sensor holding bracket.



6. Remove the holder of the Media Sensor.

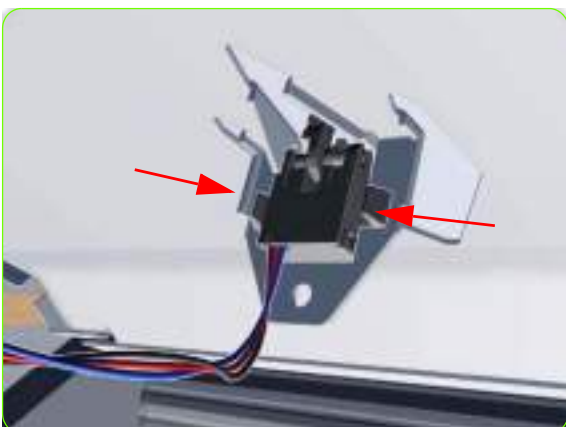

7. Unclip the Media sensor from the platen underside.



8. Let the Media Sensor hang below the Center Guide. This is to ensure it does not get damaged by the ribbon cable of the OMAS during the removal procedure.



9. Squeeze the corners of the OMAS Access Cover release it from the bottom of the printer.



10. Remove the OMAS Access Cover the printer.

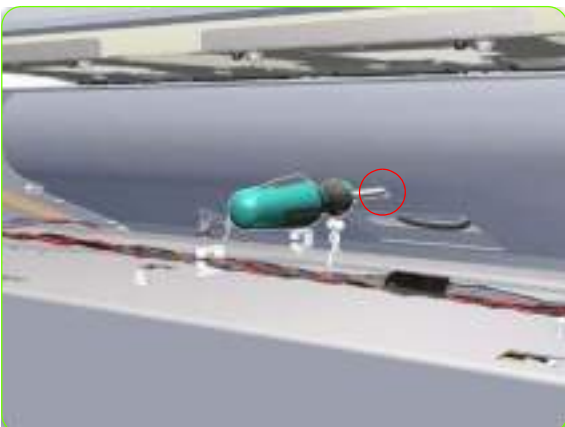

11. Insert the T-20 thin bladed torx screwdriver (supplied with the replacement OMAS) into the access hole at the rear of the printer.

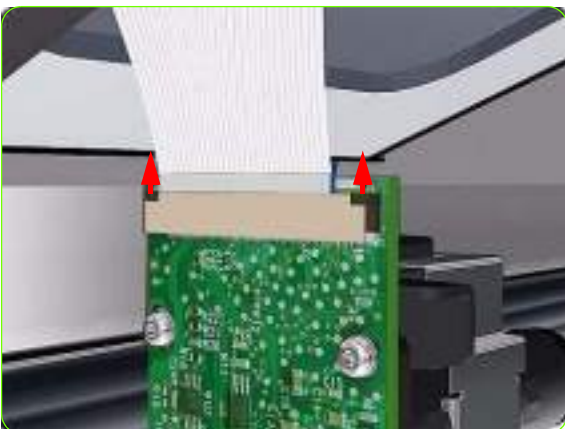

12. Remove and discard one T-20 screw which secures the OMAS horizontally to the printer.
13. From the bottom of the printer, remove and discard one T-20 screw which secures the OMAS vertically to the printer.
14. Carefully lower the OMAS from the printer as far as you can with the large ribbon cable still connected.
15. Release the two locking clips of the large ribbon cable connector.

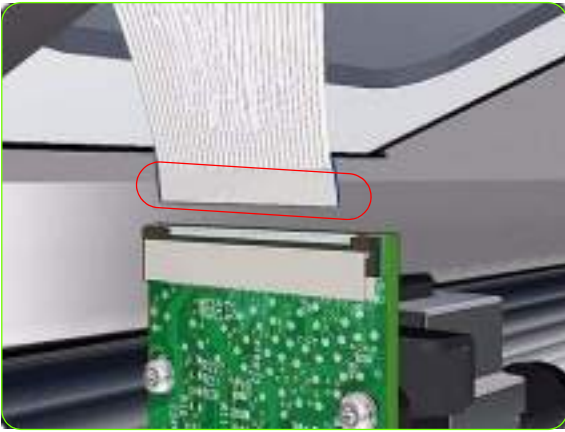

16. Disconnect the large ribbon cable from the OMAS.



17. Remove the OMAS Sensor from the printer.

Installation



NOTE: To simplify the installation of the OMAS an Attachment Screw Retainer has been added to hold the two T-20 attachment screws. This part is delivered attached to the replacement OMAS unit with the two attachment screws. It is also delivered as a separate part with the Center Platen in case the OMAS is completely removed during its replacement.



1. Verify that the two T-20 attachment screws are correctly positioned in the Attachment Screw Retainer.

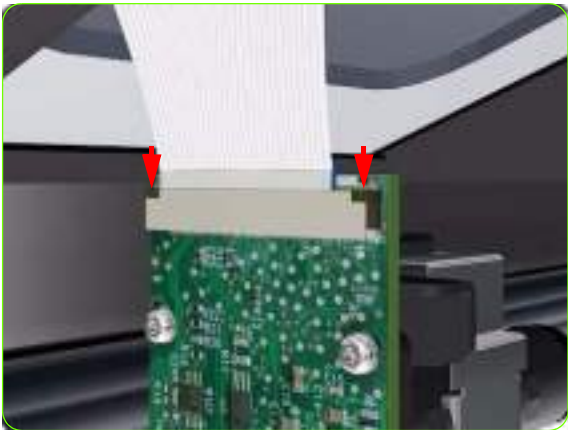
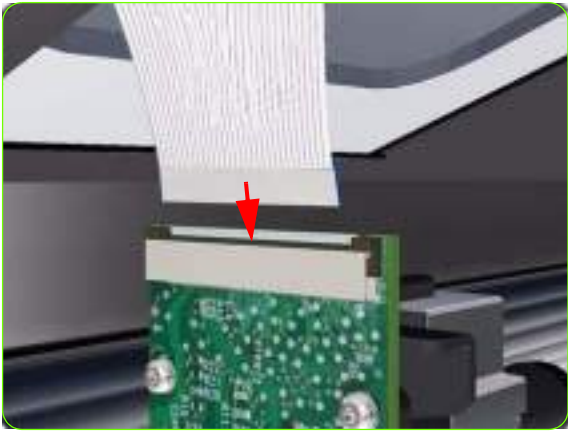

2. Position the OMAS under the Printer and connect the large ribbon.
3. Lock the clips of the large ribbon cable connector.
4. **FULLY** tighten the T-20 vertical attachment screw.
5. While installing the OMAS, take care not to trap the cable of the TOMAS.



- Carefully push the OMAS fully up into its mounting so that the OMAS window protrudes slightly **ABOVE** the Center Platen (approximately 0-2 mm). To ensure the OMAS is correctly positioned, slide a sheet of paper over the Platen Ribs until it is stopped by the OMAS. This ensures the OMAS is protruding slightly above the platen.



CAUTION: Make sure the OMAS is pushed completely up into its mounting or you will encounter an error during the OMAS calibration because it will not be able to focus on the paper.



- Slide a sheet of paper over the OMAS window, if the paper is not stopped by the OMAS, repeat previous steps to ensure the OMAS is pushed fully up into its the mounting.



- Insert the T-20 thin bladed torx screwdriver into the access hole at the rear of the printer.



- Fully tighten the T-20 horizontal attachment screw which secures the OMAS to the printer.

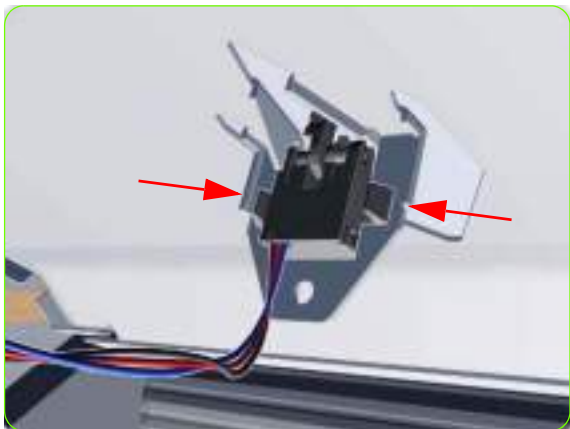

10. Clip the Media Sensor to the Center Guide.

11. Install the holder of the Media Sensor.

12. Install one T-10 screw into the Media sensor holding bracket.

13. Clip the OMAS access cover back into place by sliding one edge of the cover into the slot and then applying enough pressure to it so you can clip it into the other slot.



NOTE: After installing the NEW OMAS, perform the following Service Calibration:

- "5.3.2 Calibrate the OMAS" ⇒ See page 207.
- "5.3.3 OMAS Temp" ⇒ See page 211.
- Reset the life counter "4.3.3.Reset OMAS Sensor cycle" ⇒ See page 200.

TOMAS: Temperature Optical Media Advance Sensor

Removal



WARNING! Switch off the printer and remove the power cable.



NOTE: To simplify the installation of the TOMAS an Attachment Screw Retainer has been added to hold the two T-20 attachment screws. This part is delivered attached to the replacement TOMAS unit with the two attachment screws. It is also delivered as a separate part with the Center Platen in case the TOMAS is completely removed during its replacement.

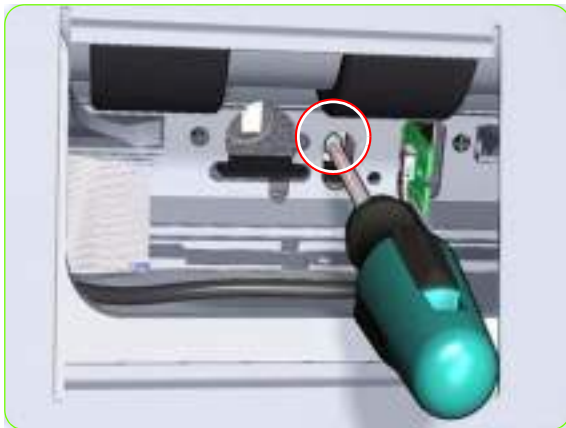

1. Remove the Right Cover ⇒ See page 319.
2. Remove the Rear Cover ⇒ See page 332.
3. Remove media if installed.
4. Remove OMAS ⇒ See page 424.
5. Remove one T10 screw that secures the TOMAS to the under side of the platen.

6. Release TOMAS from the holder in the plate.



7. Pull out the TOMAS and cable from the underside of the platen, and disconnect the cable.



8. For installing the new TOMAS a screw is held in the bracket for easier installation.



9. Insert the new TOMAS into the hole underneath the platen.

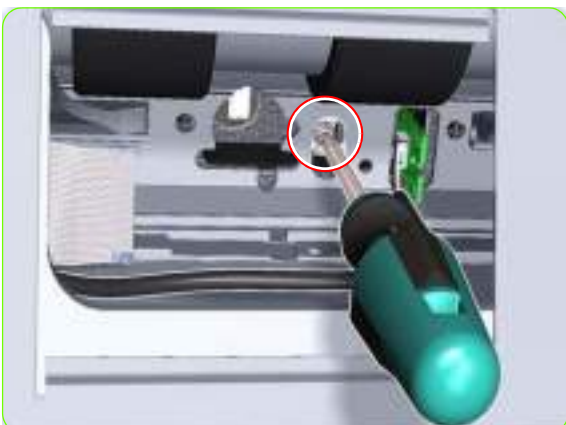

10. Tighten the screw held by the bracket into the platen.
11. There are some important notes on installing the OMAS if it has been removed while removing the TOMAS ⇒ See page 427.
12. Install the screw holder onto the OMAS and reinstall it.

TOMAS Cable

Removal



WARNING! Switch off the printer and remove the power cable.

1. Remove the Right Cover ⇒ See page 319.
2. Primer Assembly ⇒ See page 355.
3. Primer Valves ⇒ See page 357.
4. Remove the Drop Detector ⇒ See page 377.
5. Remove the Service Station ⇒ See page 364.
6. Remove OMAS ⇒ See page 424.
7. Remove TOMAS ⇒ See page 431.
8. Unroute the TOMAS Cable from the right side of the chassis.

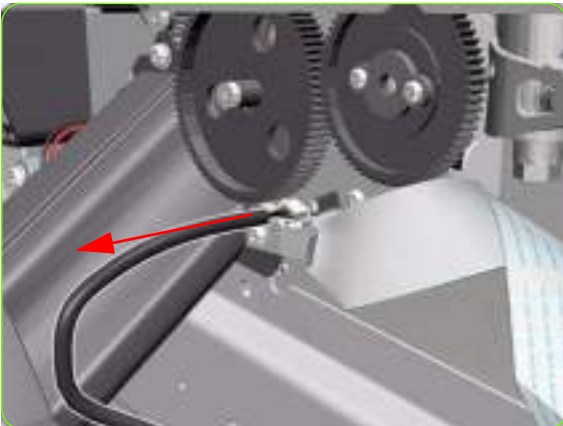
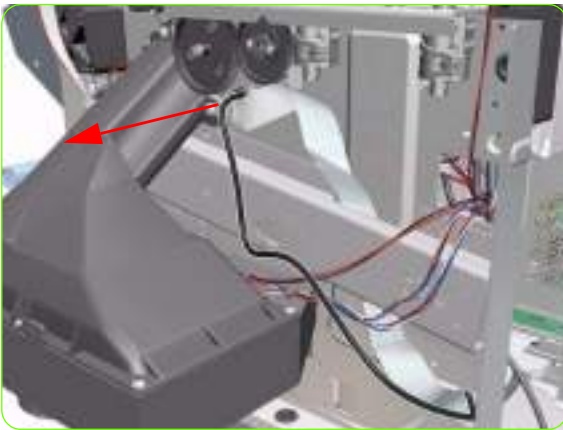

9. Remove the TOMAS cable from the hole in the chassis.



10. Disconnect the TOMAS cable from the Interconnect board.

Interconnect PCA

Removal



WARNING! Switch off the printer and remove the power cable.

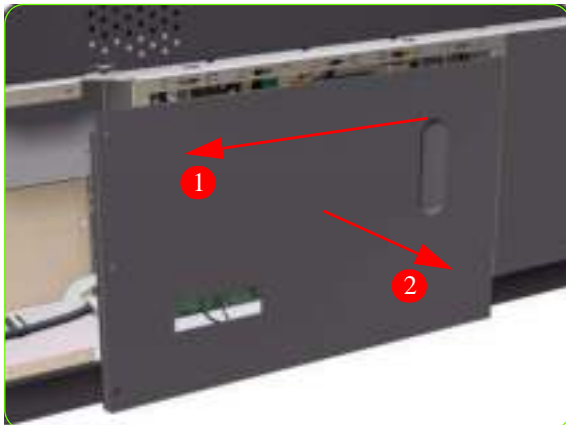

1. Remove the Right Connector Cover ⇒ See page 341.
2. Remove three T-20 screws (**Type A**) that secure the Main PCA cover.

3. Remove the Main PCA Cover from the Printer.

4. Remove six T-10 screws (**Type I**) that secure the Interconnect PCA Cover.



5. Remove the Interconnect PCA Cover from the Printer.



6. Disconnect ALL cables from the Interconnect PCA.



7. Remove five T-10 screws (**Type I**) that secure the Interconnect PCA.



8. Remove the Interconnect PCA from the Printer.

OMAS Controller Card

Removal



WARNING! Switch off the printer and remove the power cable.

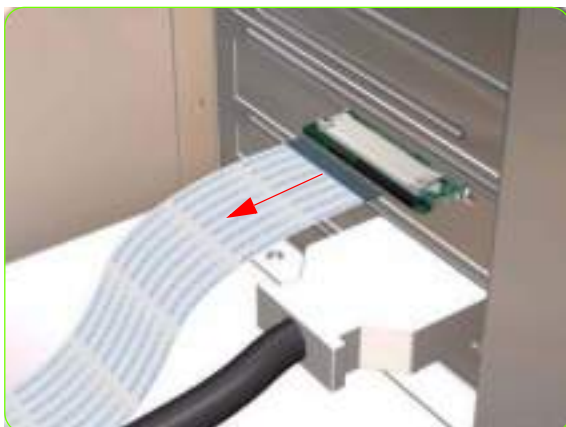
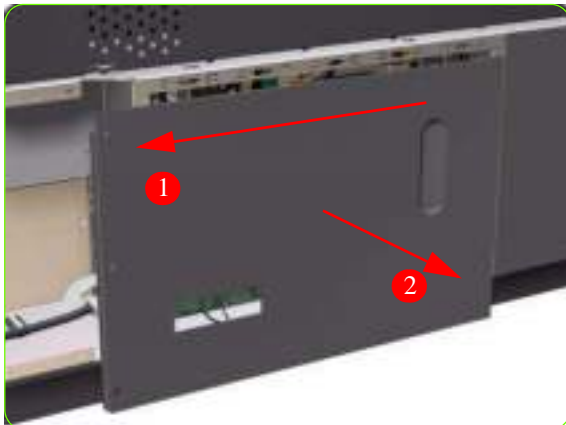

1. Remove the Right Connector Cover ⇒ See page 341.
2. Remove three T-20 screws (**Type A**) that secure the Main PCA cover.
3. Remove the Main PCA Cover from the Printer.
4. Disconnect the OMAS Controller Card to OMAS ribbon cable.

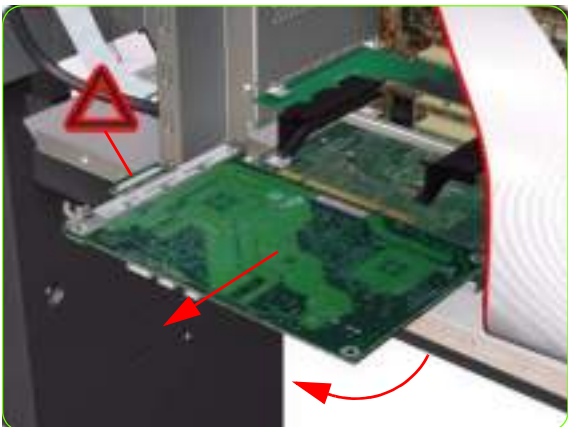
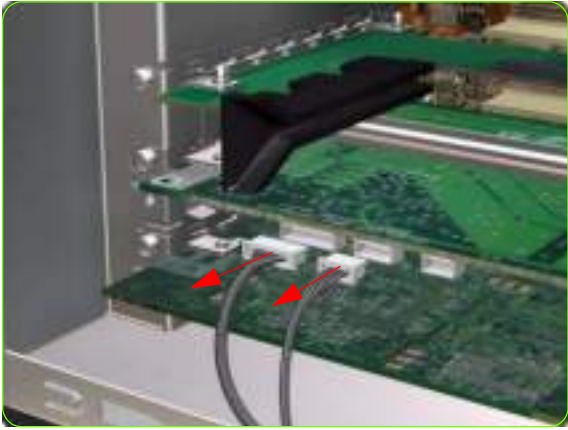

5. Disconnect the OMAS Controller Card to PrintMech and Sausalito PCI connection cables.

6. Remove one T-10 screw (**Type I**) that secures the OMAS Controller Card.

7. Disconnect the OMAS Controller Card from the Main PCA and remove from the Printer.



CAUTION: To remove the OMAS Controller Card without damaging it on the Emodule cover, you will need disconnect it first and then rotate it slightly in the direction indicated.



NOTE: After installing a new OMAS Controller Card, perform the following:

- "5.3.3 OMAS Temperature Calibration" ⇒ page 211.

OMAS Cable

Removal



WARNING! Switch off the printer and remove the power cable.



1. Remove the Right Cover ⇒ See page 319.
2. Remove the Right Connector Cover ⇒ See page 341.
3. Remove the Service Station ⇒ See page 364.
4. Remove the OMAS ⇒ See page 424.
5. Remove one T-15 screw that secures the OMAS Cable clamp from the printer.

6. Remove the OMAS Cable clamp from the printer.

7. Carefully Pull the OMAS Cable out of the Vacuum Beam.



8. Disconnect the OMAS Cable from the OMAS Controller Card.

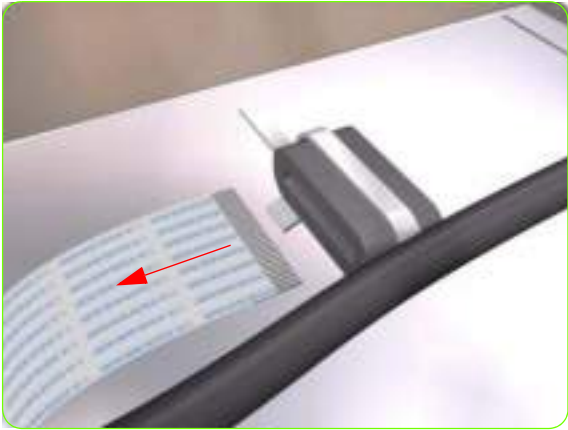

9. Unroute the OMAS Cable from the Ferrite Core.



10. Unroute and remove the OMAS Cable from the Printer.

Installation



CAUTION: It is critical that the OMAS Cable is correctly positioned in the Vacuum Beam so that it does not cause physical interference to the Media Sensor.

The following illustration shows a cross-section of the Vacuum Beam with the OMAS Cable correctly routed to avoid interference to the Media Sensor.

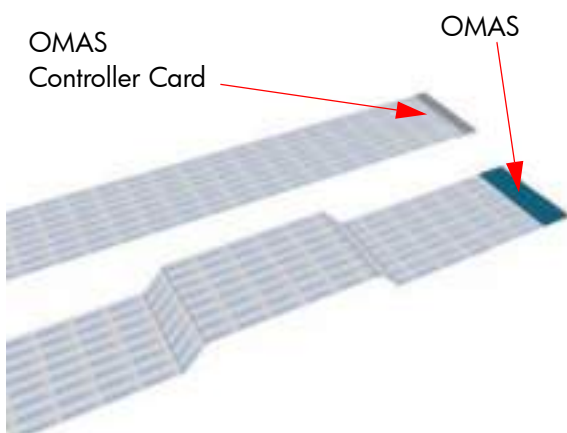

1. Before you can start to install the OMAS Cable you must first identify which end connects to which component. The end of the cable that has the most perpendicular and diagonal folds is the end that connects to the OMAS with the blue reinforcing on the top. The other end must be connected to the OMAS Controller Card with the blue reinforcing on the bottom.



1. Carefully slide the Ferrite Core and its associated attachment plate out of the vacuum beam.

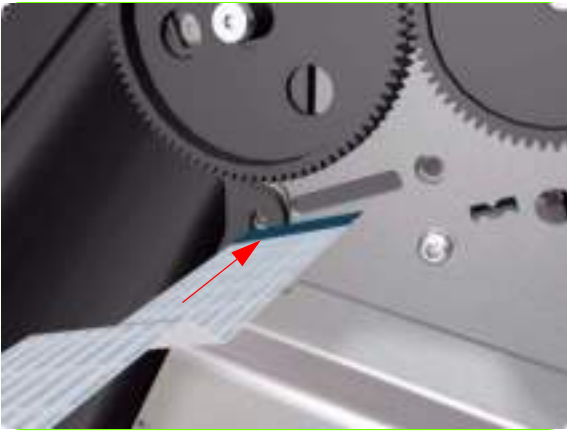

2. Position the OMAS Cable in the Vacuum Beam slot so that the blue reinforcement enters first.



3. Carefully feed the OMAS cable through the Vacuum Beam sufficiently to have approximately 20 cm hanging from the OMAS installation position.



4. Slide the Ferrite Core and its associated Attachment Plate (on the top) onto the OMAS Cable.



5. Push the Attachment Plate into its slot in the Vacuum beam until it is level with the edge of OMAS installation position.

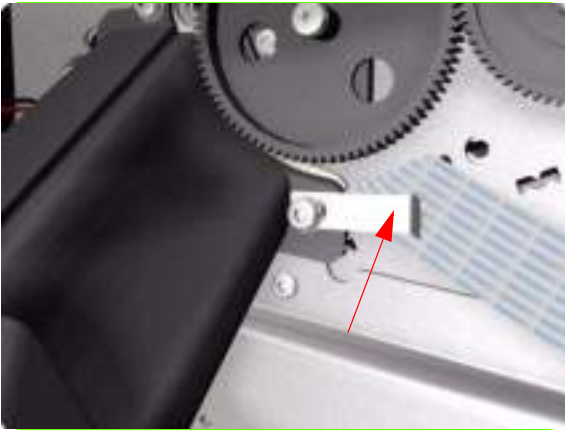

6. Carefully pull the OMAS Cable back into the Vacuum Beam (from the Service Station end) until the straight fold immediately before the first diagonal fold (from the OMAS sensor end) is aligned with the slot, fold the OMAS Cable across the diagonal fold, and install the cable clamp to lock the OMAS Cable in the correct position.



7. Route the OMAS Cable to the Ferrite Core in the Right Interconnect panel.

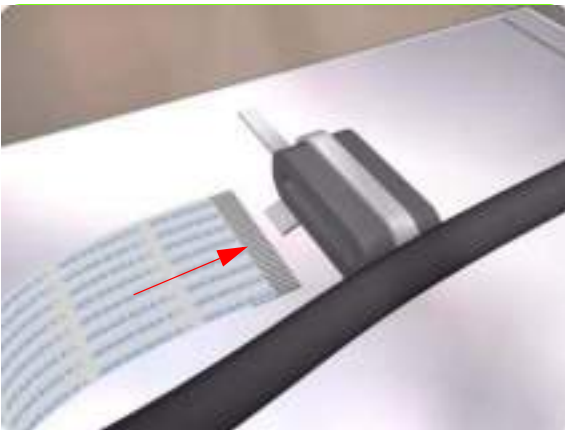

8. Feed the OMAS Cable through Ferrite Core.



9. Connect the OMAS Cable to the OMAS Controller Card with the connections on the top.

Sausalito PCI PCA

Removal



WARNING!: Switch off the printer and remove the power cable.



1. Remove the Right Connector Cover ⇒ See page 341.
2. Remove three T-20 screws (**Type A**) that secure the Main PCA cover.

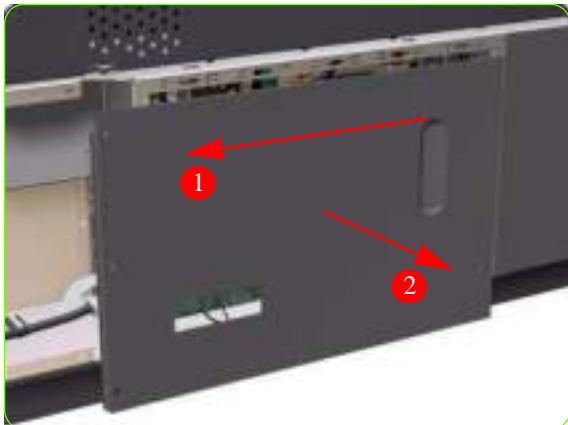

3. Remove the Main PCA Cover from the Printer.

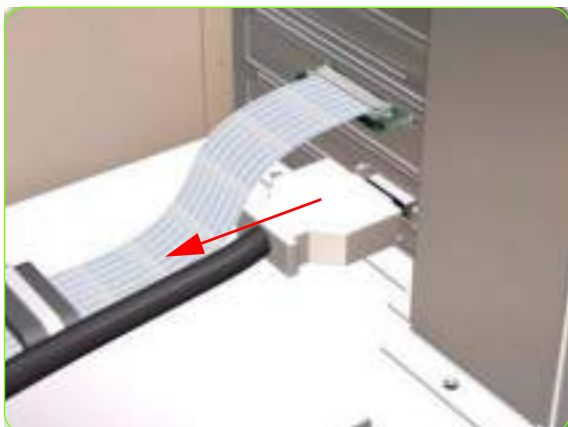

4. Disconnect the Trailing Cable from the Sausalito PCI PCA.



5. Disconnect ALL cables connected to the Sausalito PCI PCA.



6. Remove one T-10 screw (**Type I**) that secures the Sausalito PCI PCA.

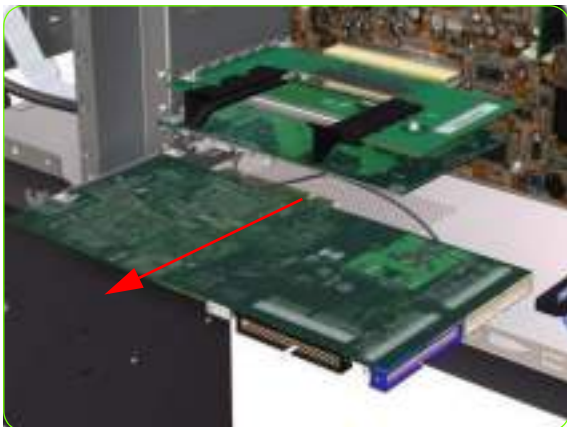

7. Disconnect the Sausalito PCI PCA from the Main PCA, unclip it, and remove it from the Printer.

CPU Fan

Removal



WARNING!: Switch off the printer and remove the power cable.



1. Remove the Right Connector Cover ⇒ See page 341.
2. Remove three T-20 screws (**Type A**) that secure the Main PCA cover.

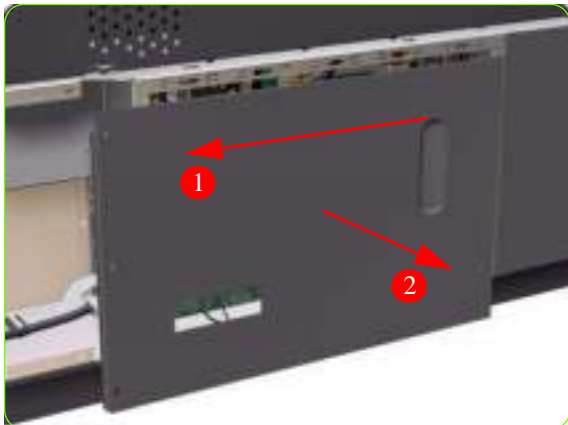

3. Remove the Main PCA Cover from the Printer.



4. Disconnect the CPU Fan Cable from the Formatter PCA.

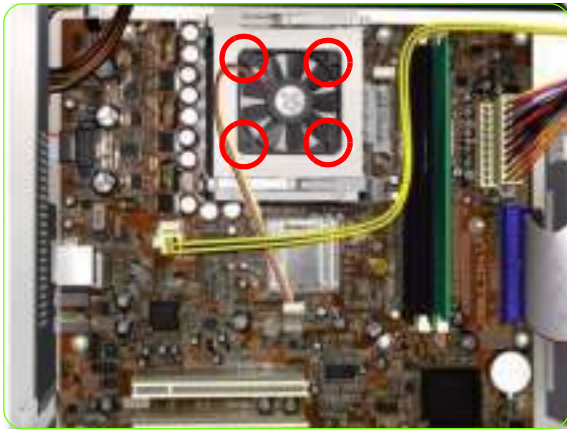

Installation



5. Remove four cross-head screws from the CPU Fan and remove the CPU Fan.

1. When installing the new CPU Fan it is important to ensure the correct orientation of the CPU Fan. There are two manufactures of fan available:
 - AAVID Fans - AAVID Labels faces outwards when it is installed correctly.

- Delta Fans - CE Label faces inwards, towards the printer when it is installed correctly.

Memory Module

Removal



WARNING!: Switch off the printer and remove the power cable.



1. Remove the Right Connector Cover ⇒ See page 341.
2. Remove three T-20 screws (**Type A**) that secure the Main PCA cover.

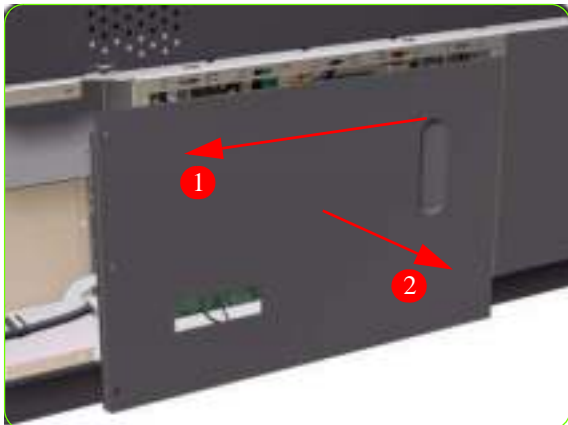

3. Remove the Main PCA Cover from the Printer.

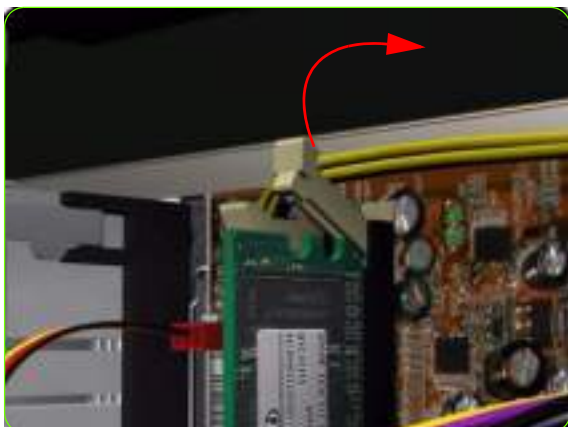

4. Push the Memory Module Connector clips up and down to release the Memory Module.

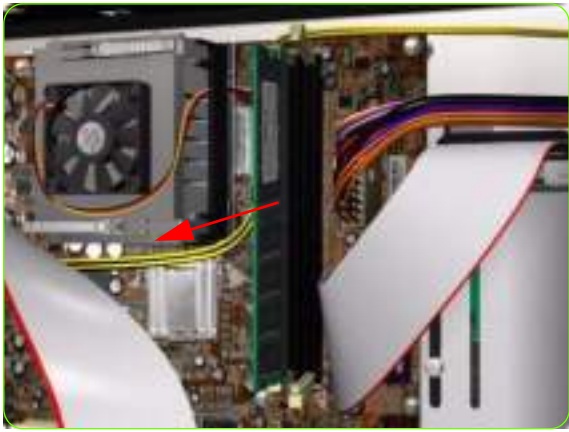

5. Remove the Memory Module from the Printer.

Main PCA Formatter

Removal



WARNING!: Switch off the printer and remove the power cable.



CAUTION: Do NOT remove the Fan or the Processor (located under the Fan) from the Main PCA Formatter - The Fan and the Processor are part of the Main PCA Formatter support part and should be replaced as one assembly.

1. Remove the Sausalito PCI PCA ⇒ See page 444.
2. Remove the Memory Module ⇒ See page 448.
3. Disconnect ALL cables connected to the Main PCA Formatter.



4. Remove eight T-10 screws (**Type I**) that secure the Main PCA Formatter.

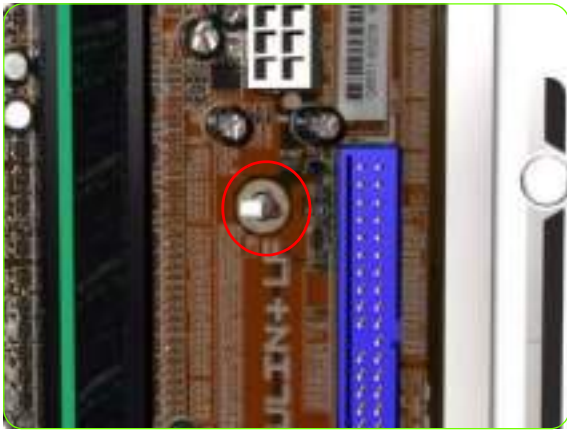

5. Release the plastic locating pin that secures the Main PCA Formatter.



6. Remove the Main PCA Formatter from the Printer.



NOTE: When installing the Main PCA Formatter, make sure that you first locate it on the plastic locating pin and then install the screws.

Hard Disk Drive (HDD)

Removal



WARNING!: Switch off the printer and remove the power cable.



1. Remove the Right Connector Cover ⇒ See page 341.
2. Remove three T-20 screws (**Type A**) that secure the Main PCA cover.

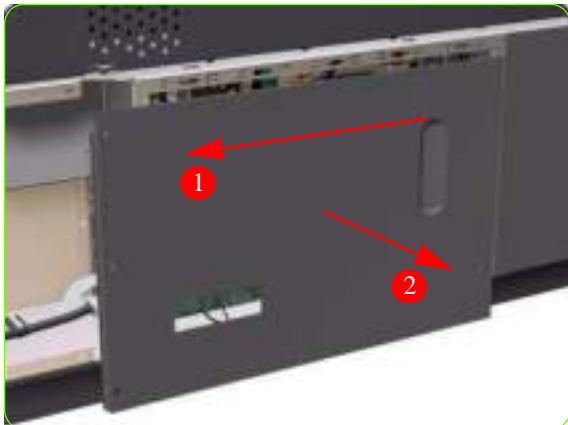

3. Remove the Main PCA Cover from the Printer.



4. Disconnect ALL cables connected to the Hard Disk Drive.

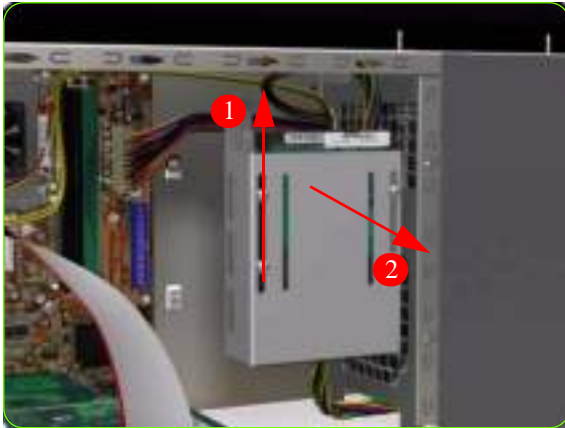
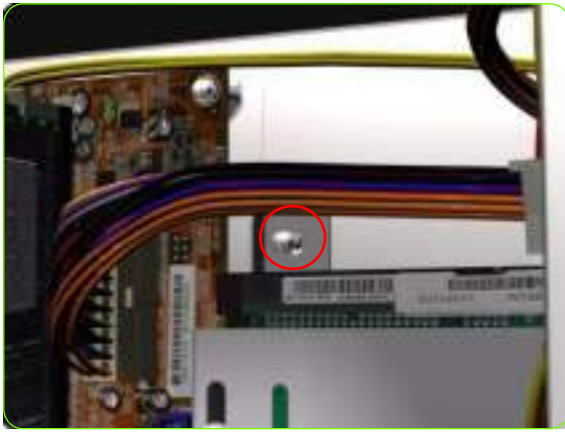

5. Remove one T-10 screw (**Type I**) from the HDD Holder.

6. Slide the Hard Disk Drive upwards and remove from the Printer.



NOTE: It is not necessary to remove the screws securing the HDD inside the metal casing.

NOTE: After installing the NEW HDD, make sure you perform the following User Calibrations:

- Printhead Alignment.
- Paper Advance Calibration.
- Color Calibration.



NOTE: After installing the NEW HDD, make sure you perform the following Service Utility:

- Carriage PCA Setup ⇒ Chapter 4.



NOTE: You **MUST NEVER** replace both the Hard Disk Drive and the Ink Supply Tubes and Trailing Cable at the same time. If both parts need to be replaced, you **MUST** first replace one part and then power **ON** the Printer until it completely initializes. Then you can power **OFF** the Printer and replace the other part.

PATA to SATA PCA

Removal



WARNING!: Switch off the printer and remove the power cable.



1. Remove the Right Connector Cover ⇒ See page 341.
2. Remove three T-20 screws (**Type A**) that secure the Main PCA cover.

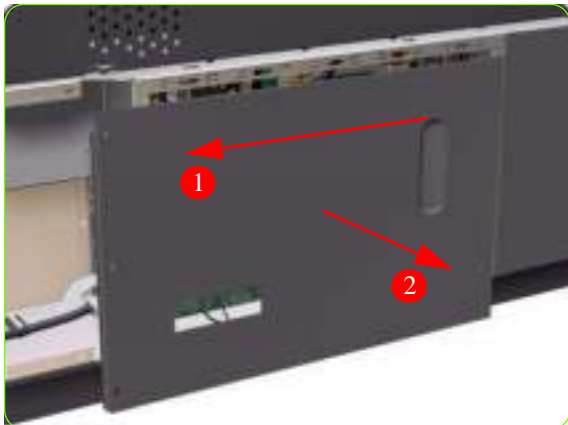

3. Remove the Main PCA Cover from the Printer.



4. Disconnect the Pata to Sata PCA from the Main PCA.

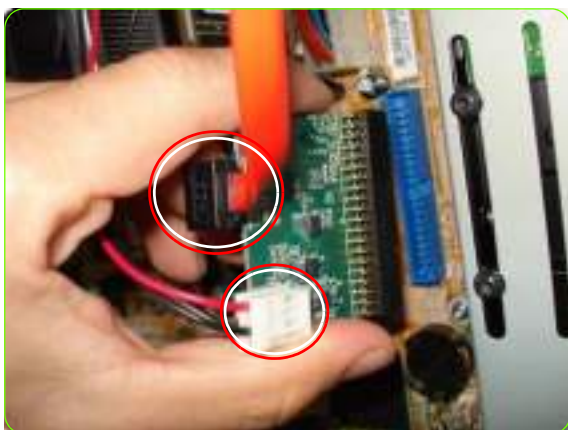

5. Disconnect the two connectors from the Pata to Sata.

Installation

When installing the new PATA to SATA, the orientation of the board is important, as it is possible to install incorrectly:

- Ensure the board is inserted in the center of the receiving socket.
- Make sure the orientation of the connections are as shown as the part is installed.

Power Supply Unit (PSU)

Removal



WARNING!: Switch off the printer and remove the power cable.

1. Remove the Left Cover ⇒ See page 325.
2. Remove the Right Connector Cover ⇒ See page 341.
3. Remove:
 - For the 42-inch model, the Left Connector Cover ⇒ See page 343.
 - For the 60-inch model, the Electronics Module Extension ⇒ See page 344.
4. Remove three T-20 screws (**Type A**) that secure the Main PCA cover.

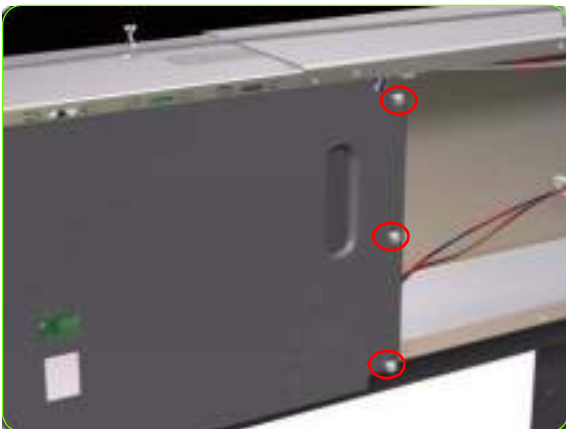
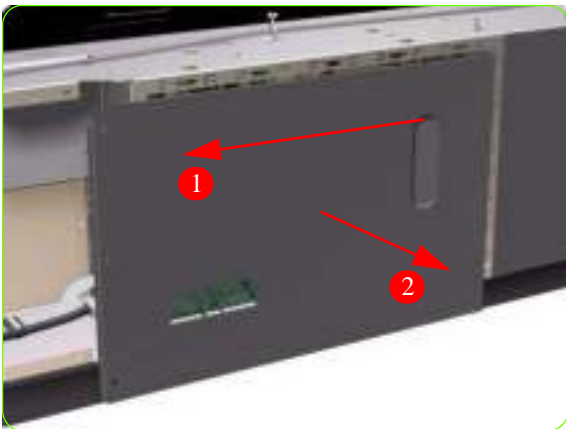

5. Remove the Main PCA Cover from the Printer.

6. Remove three T-20 screws (**Type A**) that secure the PSU cover.

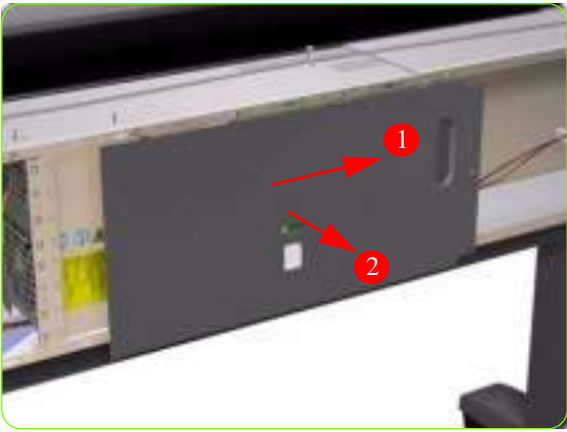

7. Remove the PSU Cover from the Printer.



8. Remove one T-20 screw from underneath the AC Dryer Input Assembly



9. Remove two T-20 screws from the AC Dryer Input Assembly.



10. Slide the AC Dryer Assembly to the left.



11. Pull out (but do not remove) the AC dryer Input Assembly from the rear of the printer.



12. Locate the cable shown.



13. Disconnect the cable shown.



14. Locate the cable shown.



15. Disconnect the cable shown.

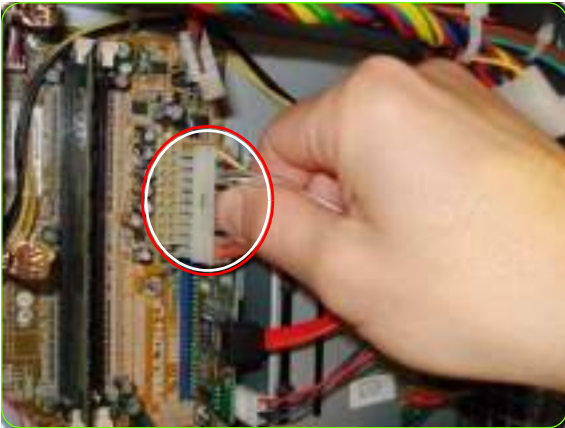

16. Disconnect one cable from the Interconnect PCA.



17. Disconnect two power cables from the Main PCA, just below the CPU Fan.

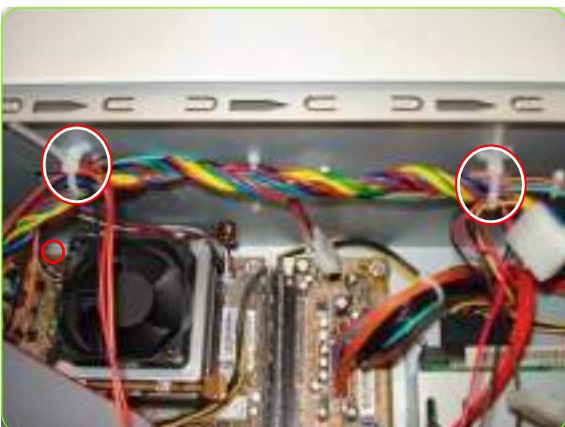

18. Remove the bundle of cables from two cable clamps.

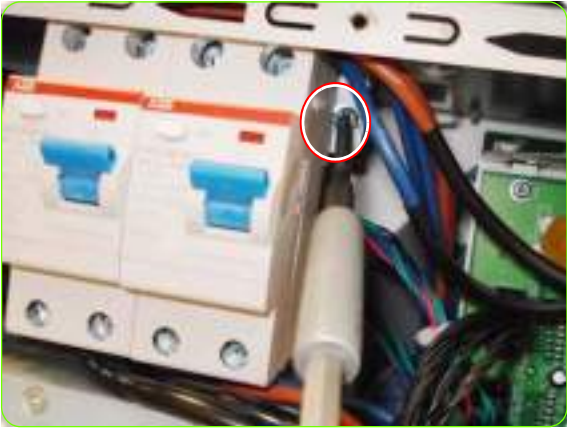

19. Remove one T-20 screw from next to the Circuit Breaker.



20. Slide out both Circuit Breakers.



21. Remove the Circuit Breakers but do not disconnect them.



22. Disconnect the Curing Module Circuit Breaker cable.



23. Disconnect the Power Supply cable from the PrintMech PCA.



24. Remove two T-10 screws (**Type I**) from the back of the PSU Assembly.



25. Remove two T-10 screws (**Type I**) from the PSU Assembly.



26. Disconnect the cable from the Sausalito PCA.



27. Push the cable through the cavity in the Electronics Module.



28. Pull out slightly the PSU Assembly from the Electronics Module.



29. Push the bundle of cables attached to the PSU Assembly, through a cavity at the back of the Electronics Module.



30. Pull the bundles of cables attached to the PSU Assembly through the other side.



31. The PSU Assembly can now be removed.

Formatter Battery

Removal



WARNING!: Switch off the printer and remove the power cable.

1. Remove the Right Connector Cover ⇒ See page 341.
2. Remove three T-20 screws (**Type A**) that secure the Main PCA cover.
3. Remove the Main PCA Cover from the Printer.
4. Push the clip down and release the battery from the Main PCA.

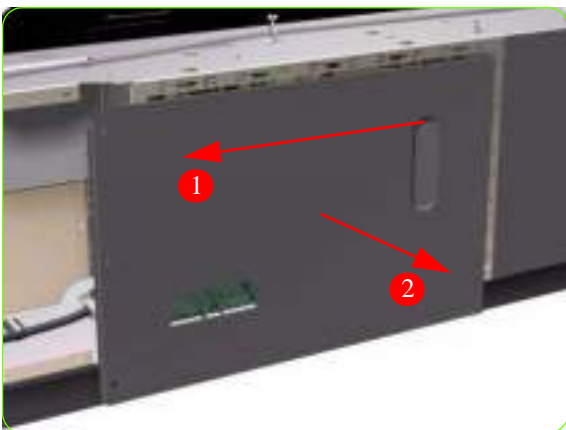

Heaters Control Assembly

Removal



WARNING! Switch off the printer and remove the power cable.



1. Remove:
 - For the 42-inch model, the Left Connector Cover ⇒ See page 343.
 - For the 60-inch model, the Electronics Module Extension ⇒ See page 344.
2. Remove four T-20 screws (**Type A**) that secure the PSU cover.
3. Remove the PSU Cover from the Printer.
4. Remove two T-20 screws from the AC Dryer Input Assembly.

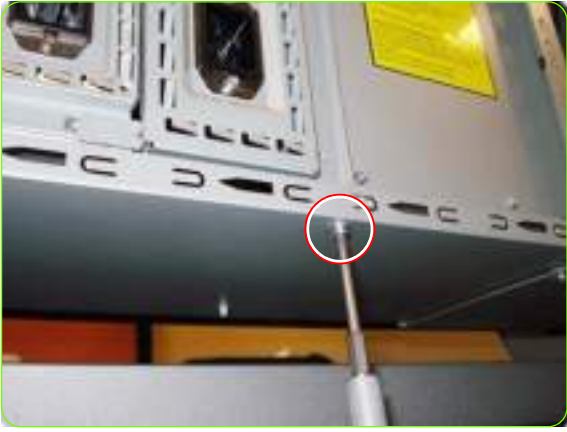

5. Remove one T-20 screw from underneath the AC Dryer Input Assembly.



6. Slide the AC Dryer Input Assembly to the left.



7. Pull out (but do not remove) the AC Dryer Input Assembly from the rear of the Printer.



8. Disconnect the connector Curing Heaters Power connector below the Heaters Control Assembly Fan.



9. Disconnect one connector (Dryer Heaters power connector) above the Heaters Control Assembly Fan.



10. Disconnect the Window Lock Sensors connector.



11. Disconnect two connectors located next to the Circuit Breakers (Sausalito & PrintMech cables). for information refer to Printer Systems ⇒ page 32.



12. Remove one T-20 screw from inside the chassis, above the Heaters Control Assembly Fan.



13. Remove one T-20 screw from underneath the 60 inch extension.



14. Remove one T-20 screw next to the Circuit Breaker.



15. Slide out the Dryer Circuit Breaker indicated.



16. Hold the Circuit Breaker upside down in one hand.



17. Loosen with a flat end screwdriver two screws from the circuit breaker.



18. Remove the two cables (brown and blue) from below the Circuit Breaker.



19. Leave the Dryer AC Input and Dryer Circuit Breaker loose hanging from the Printer.



20. Slide out the Curing Module Circuit Breaker indicated.



21. Hold the Circuit Breaker up side down in one hand.



22. Loosen with a flat end screwdriver two screws from the circuit breaker.



23. Remove the two cables (brown and blue) from below the Circuit Breaker.



24. Disconnect the curing Module Circuit breaker from the PSU of the Printer.



25. The Curing Module Circuit breaker can now be removed from the Printer.



NOTE: The next step only applies to the 60" version of the Printer.



26. Gently open up the top part and the bottom part of the 60 inch extension.



27. Pull out slightly (but do not remove) the Heaters Control Assembly.



28. Remove the Heaters Control Assembly with the Dryer AC Input and Dryer Circuit Breaker from the Printer.



29. Remove one T-20 screw securing the cable of the Dryer AC Input Assembly to the Heater Control Assembly.

Installation

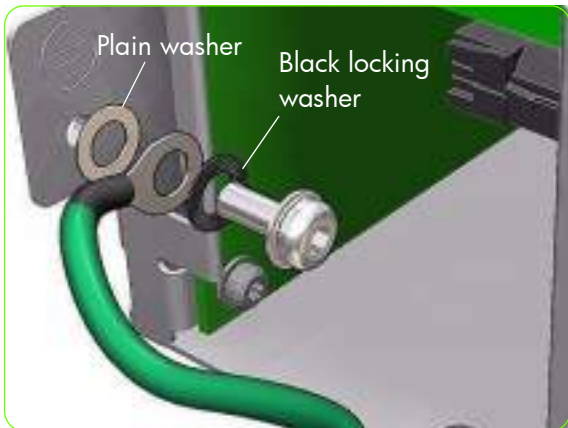

1. When installing the cable of the Dryer AC Input Assembly to the Heater Control Assembly, it is important that the washers are installed as shown here.



NOTE: After installing a new Heaters Control Assembly, perform the following:

- "2.3 Power electronics" ⇒ page 128.

Heaters Control Assembly Fan

Removal



WARNING! Switch off the printer and remove the power cable.

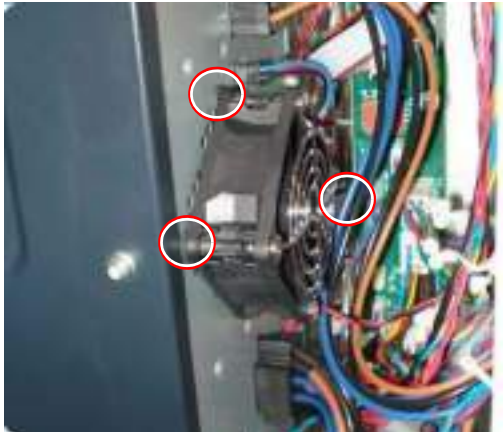

1. Remove the Left Connector Cover:
 - For the 42-inch model ⇒ See page 343.
 - For the 60-inch model ⇒ See page 344.
2. Remove the Heaters Control Assembly Fan by gently pulling it from three rubber stand-offs.

3. Disconnect the cable of the Heaters Control Assembly Fan.

Installation

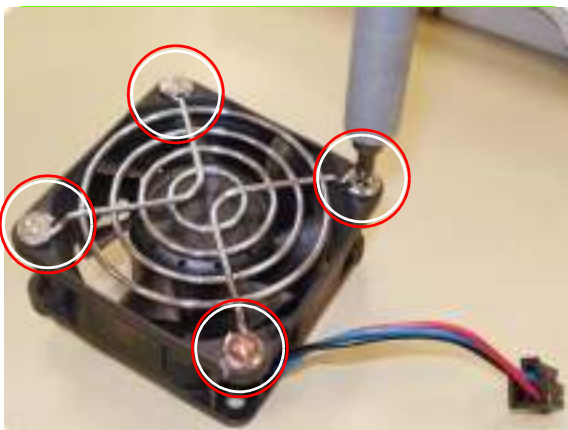

4. Remove the four screws from the old Heaters Control Assembly Fan.



5. Install three rubber stand-offs into the side of the Heaters Control Assembly.



6. Use a screw driver to push them through the holes.



7. Stand-offs correctly installed.



8. Install the fan onto the three rubber stand-offs. With the type of fan currently installed on the printer, make sure the label shown here is facing to the printer when it is being installed.

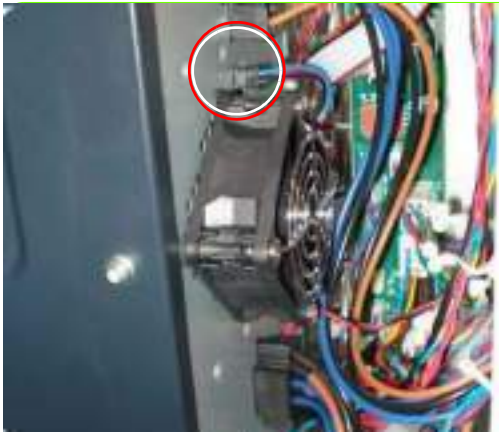

9. Connect the cable of the new fan.

Circuit Breakers

Removal



WARNING!: Switch off the printer and remove the power cable.

1. Remove:
 - For the 42-inch model, the Left Connector Cover ⇒ See page 343.
 - For the 60-inch model, the Electronics Module Extension ⇒ See page 344.
2. Remove four T-10 screws (**Type A**) that secure the PSU cover.

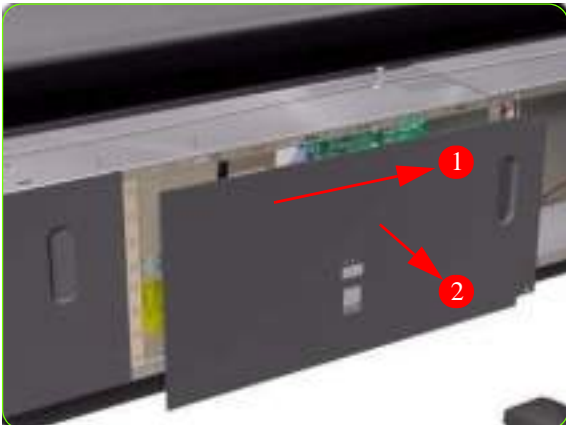
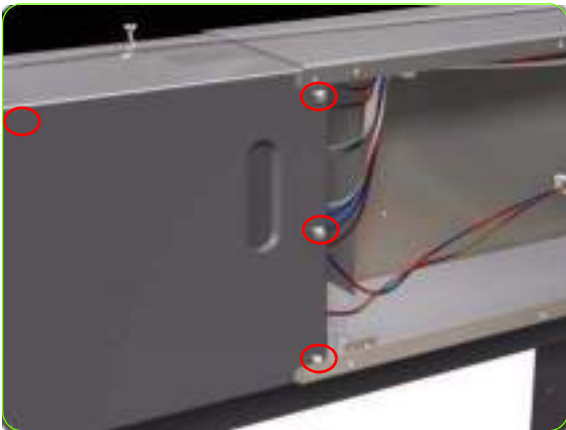

3. Remove the PSU Cover from the Printer.



4. Remove one T-20 screw next to the Circuit Breaker.



5. Slide out the Circuit Breaker.



6. Loosen four screws with a flat end screwdriver on the Circuit Breaker and remove the Circuit Breaker (repeat the process for the other Circuit Breaker).

AC Input Assembly

Removal



WARNING!: Switch off the printer and remove the power cable.

1. Remove:
 - For the 42-inch model, the Left Connector Cover ⇒ See page 343.
 - For the 60-inch model, the Electronics Module Extension ⇒ See page 344.
2. Remove four T-10 screws (**Type A**) that secure the PSU cover.

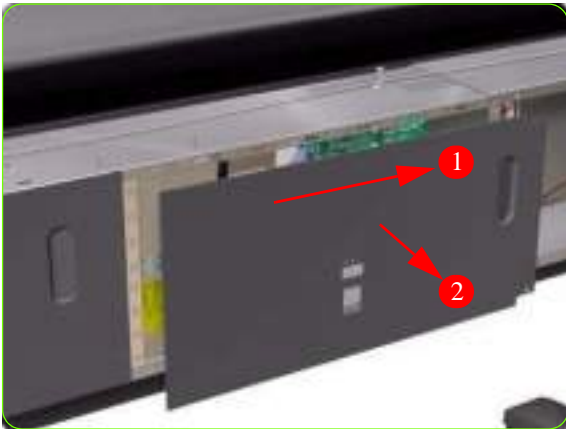
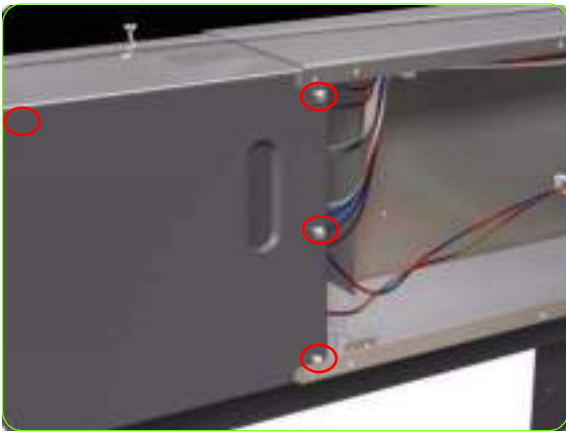

3. Remove the PSU Cover from the Printer.



4. Remove two T-20 screws from the AC Input Assembly.



5. Remove one T-20 screw from underneath the AC Input Assembly.



6. Pull out (but do not remove) the AC Input Assembly from the rear of the Printer.



7. Remove one T-20 screw next to the Circuit Breaker.



8. Slide out the Circuit Breakers to remove them.



9. Loosen two screws on the Circuit Breaker with a flat end screw driver.



10. Remove the two cables from below the Circuit Breaker.



11. Remove one T-15 screw from the safety Grounding Cable inside the Printer Chassis.



12. Note the location of the washers for when you are reinstalling this part



13. Remove the AC Input Assembly.

PrintMech PCA

Removal



WARNING!: Switch off the printer and remove the power cable.

1. Remove:
 - For the 42-inch model, the Left Connector Cover ⇒ See page 343.
 - For the 60-inch model, the Electronics Module Extension ⇒ See page 344.
2. Remove the Heaters Control Assembly ⇒ See page 465.
3. Disconnect ALL cables from the PrintMech PCA.

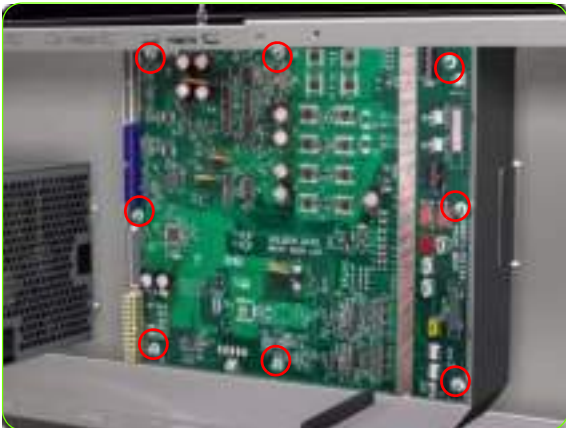

4. Remove eight T-10 screws (**Type I**) that secure the PrintMech PCA.



5. Remove the PrintMech PCA from the Printer.

Electronics Module

Removal



WARNING! Switch off the printer and remove the power cable.



1. Remove the Right Connector Cover ⇒ See page 341.
2. Remove the Left Connector Cover:
 - For the 42-inch model ⇒ See page 343.
 - For the 60-inch model ⇒ See page 344.
3. Disconnect ALL the cables connected to the right Interconnect PCA and the Sausalito PCI PCA.
4. Unroute all the disconnected cables so they are clear of the Electronics Module.
5. Remove two T-20 screws (**Type B**) that secure the right side Electronics Module.

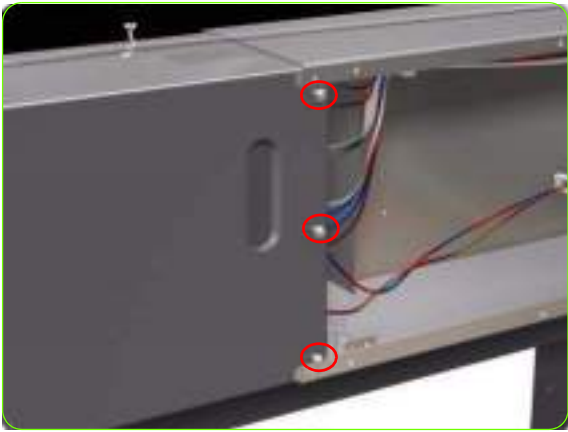

6. Remove three T-20 screws (**Type A**) that secure the PSU cover.

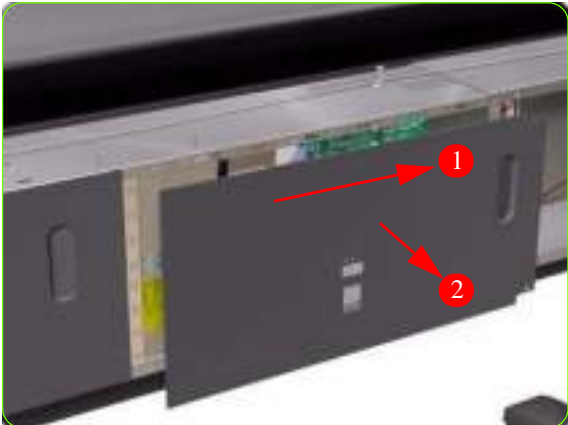

7. Remove the PSU Cover from the Printer.



8. Disconnect ALL cables from the PrintMech PCA.

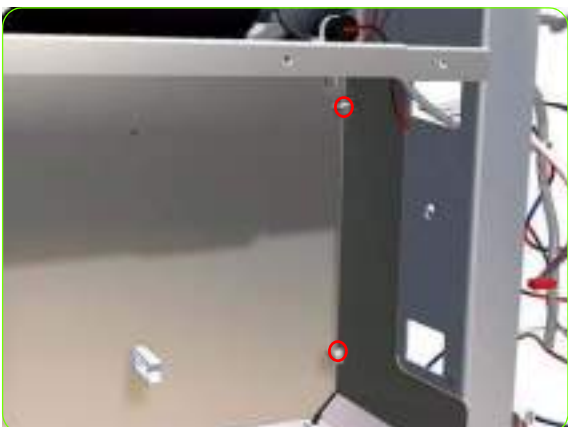

9. Remove two T-20 screws (**Type B**) that secure the left side Electronics Module.



10. Lift the Electronics Module sufficiently (approximately 2 cm) to release it from the attachments.



CAUTION: Be careful not to damage the cables on top of the Electronics Module as you remove it.



11. Remove the Electronics Module from the Printer.

Line Sensor Assembly

Removal



WARNING!: Switch off the printer and remove the power cable.

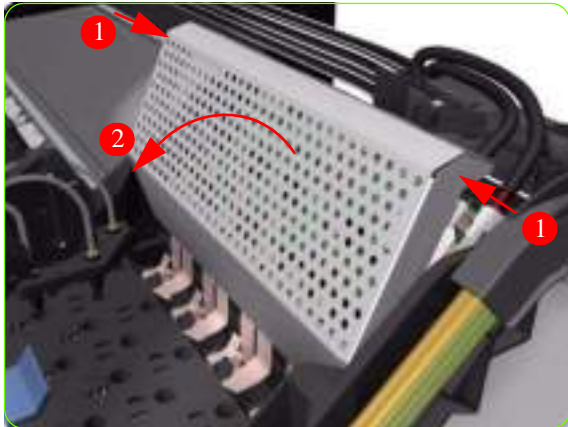

1. Remove the Right Cover ⇒ See page 319.
2. Press the two side of the Carriage PCA Cover and unclip from the Carriage Assembly.



3. Release the clip and disconnect the Line Sensor cable from the Carriage PCA.



4. Remove one T-15 screw (**Type G**) that secures the Line Sensor to the carriage Assembly.

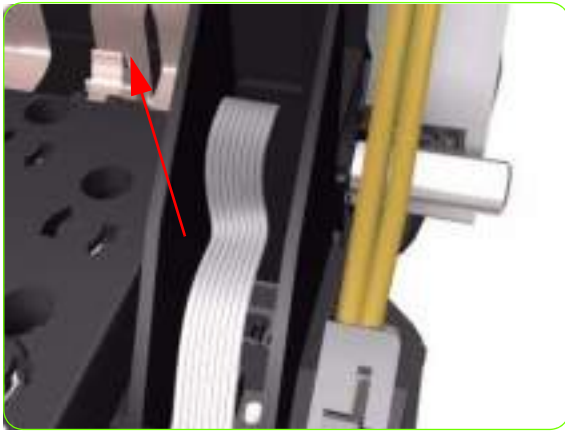

5. Remove the Line Sensor from the Carriage Assembly.



6. Remove the protective foam from around the sensor.



NOTE: After installing the NEW Line Sensor, perform the following Service Calibrations:

- "5.6.1 Line Sensor Calibration" ⇒ page 217.
- Reset the life counter "4.6.2 Line Sensor cycle" ⇒ page 200.

Color Sensor Assembly

Removal



WARNING!: Switch off the printer and remove the power cable.

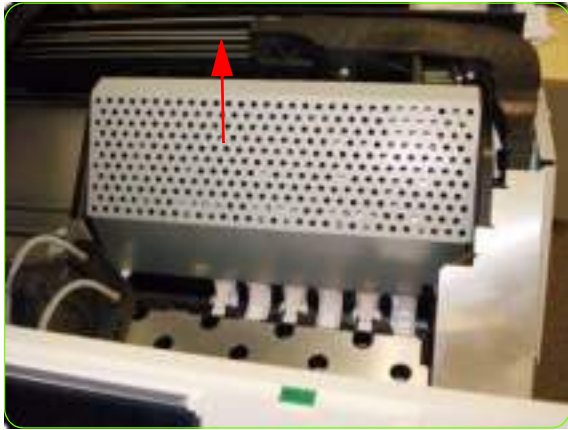

1. Open the Window.
2. Remove the Right Cover ⇒ See page 319.
3. Press the two sides of the Carriage PCA Cover, unclip it from the Carriage Assembly and remove it.
4. Release the clip and disconnect the Color Sensor cable from the Carriage PCA.
5. Uncap the Carriage Assembly by manually pulling out the Printhead Maintenance Cartridge tray.



6. Lift the Primer and hold the Primer to its maximum position to avoid damaging it when you move the Carriage Assembly in the next step.

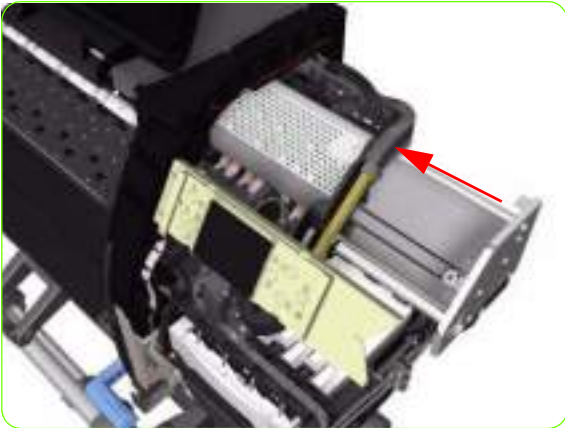

7. Move the Carriage Assembly out of the Service Station.



8. Move the Carriage Assembly to the center of the platen.



9. Remove two T-10 screws that secure the Reflector Assembly to the side of the Carriage Assembly.



10. Remove the Reflector Assembly.



11. Remove one T-10 screw from the front of the Color Sensor.



12. Remove one T-10 screw from the Rear of the Color Sensor.

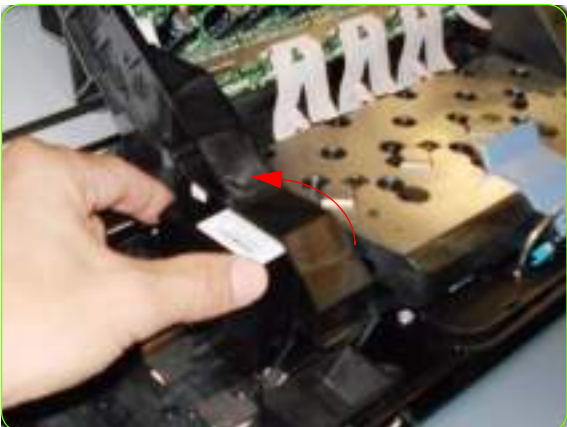

13. Tilt the Color Sensor so it can be removed.



14. Remove the Color Sensor from the Carriage Assembly.



NOTE: After installing the NEW Color Sensor, perform the following Service Calibrations:

- "5.6.3 Open Close SOL" ⇒ page 223.
- Perform the safety test "3.3 Substrate Path Sensor" ⇒ page 138.
- Reset the life counter "4.6.5 Color sensor" ⇒ page 200.

Color Sensor Actuator Assembly

Removal



WARNING!: Switch off the printer and remove the power cable.



1. Remove the Left Cover ⇒ See page 325.
2. Slide out the top row of Ink Cartridges from the Ink Supply Station

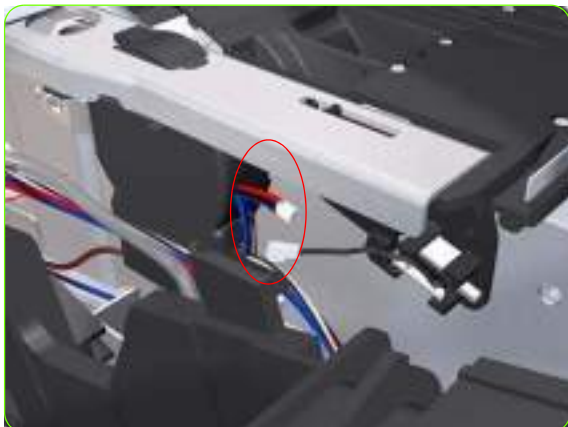

3. Disconnect the Color Sensor Actuator Assembly.



4. Remove one T-15 screw (**Type G**) that secures the Color Sensor Actuator Assembly to the printer.

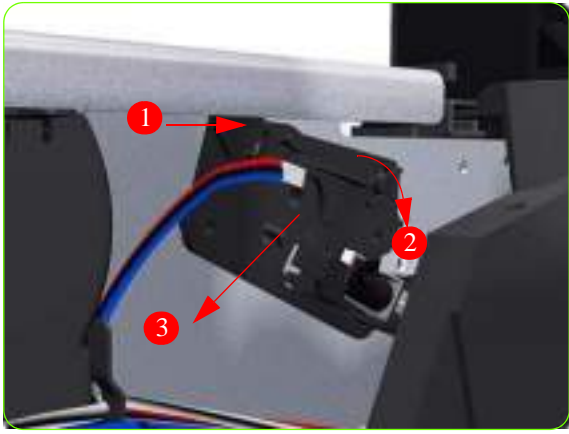

5. Remove the Color Sensor Actuator Assembly to the printer.

Dryer Grill

Removal



WARNING!: Switch off the printer and remove the power cable.



1. Open the Window ⇒ See page 309.

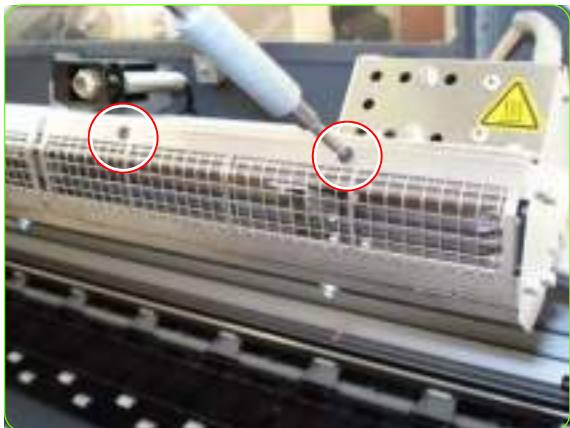

2. Remove two T-10 countersunk screws securing one section of Dryer Grill.



3. Tilt the Dryer Grill downwards.

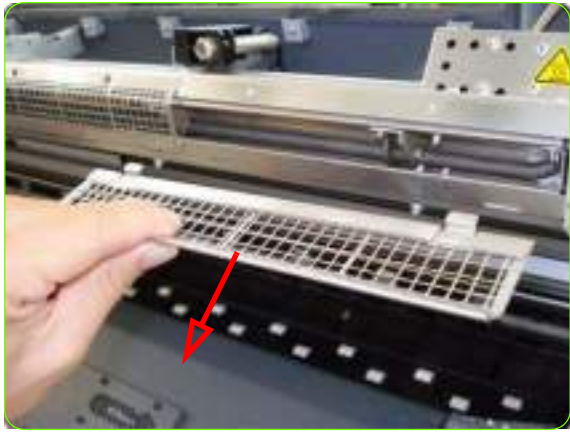

4. Remove the Dryer Grill.

Dryer (IR) Temperature Sensor

Removal



WARNING!: Switch off the printer and remove the power cable.

1. Twist the Window Locks and open the Dryer Window.
2. Remove the Left Cover ⇒ See page 325.
3. Disconnect the Dryer Temperature Sensor cable from the left side of the printer.



4. Remove one T20 screws from the cable clamp.

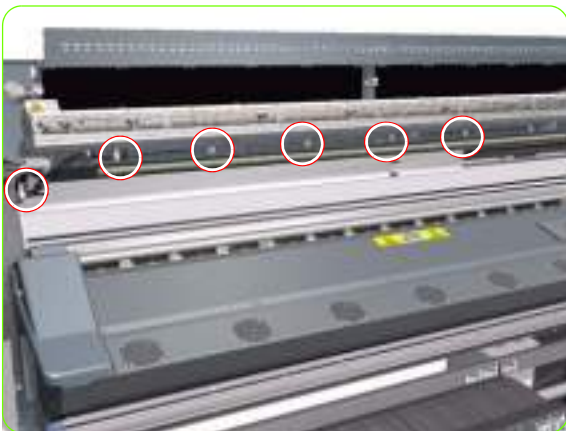

5. Remove all the T20 screws from cable clamps that secure the Temperature Sensor Cable to the inside of the Dryer Window Assembly.



6. Remove two thin nuts from the Dryer Temperature Sensor.



7. Remove the Dryer Temperature Sensor from the holder.



8. Remove the Dryer Temperature Sensor Cable from the cable clamps.



9. Remove the Dryer Temperature Sensor and cable from the printer.



NOTE: After installing the NEW Dryer IR temp sensor, perform the following Service Calibrations:

- Reset the life counter "4.8.4 Reset Heating Sensor" ⇒ page 201.

Dryer Heater

Removal



WARNING!: Switch off the printer and remove the power cable.

1. Remove the Left Cover ⇒ See page 325.
2. Remove the Dryer Grills ⇒ See page 494.
3. Remove one T-10 screw from a clamp that secures the cable of the Dryer Heater.



4. Loosen two screws on the connector of the Dryer IR Temperature Sensor cable, by hand or with a flat screwdriver, and disconnect.



5. Remove one T25 screw, one lock washer, one normal washer that secures the grounding cable.



WARNING!: To ensure the electrical safety of the Printer, it is very important that this grounding cable is reinstalled after the new part has been installed.



WARNING!: When reinstalling the grounding cable, it is an important safety point that the washers are installed as shown here.



6. Push the grounding cable to one side.



7. Remove one T-20 screw from a cable clamp that secures the grounding and Dryer Temperature Sensor cable to the left Arc.

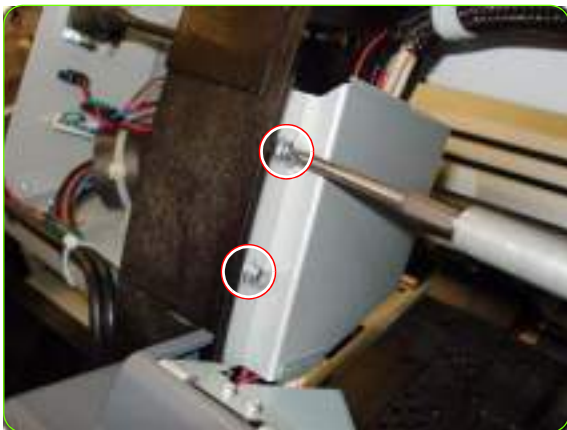

8. Remove two T-20 screws that secure the Left Cable Plate to the printer.



9. Lift up the Left Cable Plate



10. Remove the Left Cable Plate.

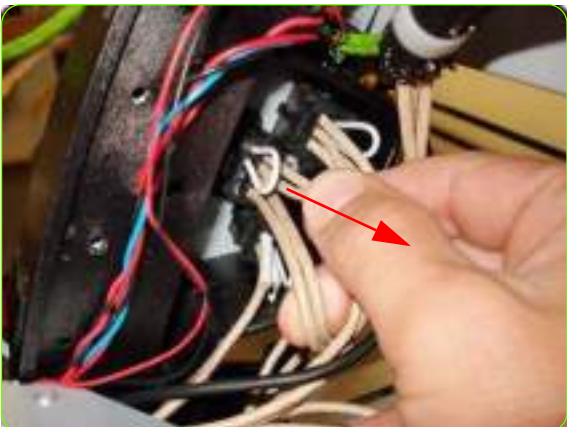

11. Disconnect the Dryer Power Cable.



12. Remove one T-20 screw from a cable clamp that secures the Dryer Heater Power cables to the left side.

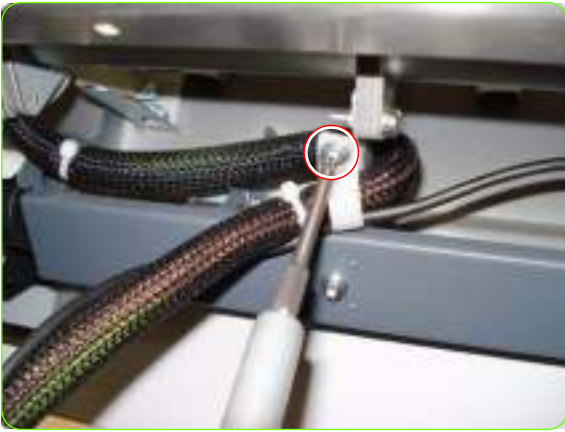

13. Remove one T-20 screw from a cable clamp that secures the Dryer Heater Power cables in the Window cavity.



14. Remove the cable of the Dryer IR Temperature Sensor from the cable clamp.



15. Push the Dryer power cable and grounding cable back through the cavity of the Window Assembly.

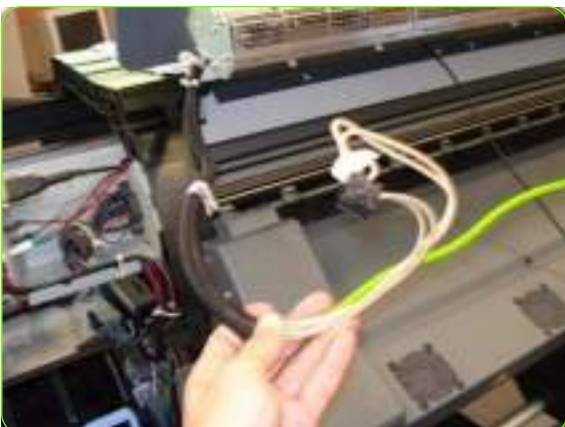

16. Remove the cable from inside the cavity of the Window assembly.



17. Remove all the T-20 screws that secure the Dryer Assembly to the inside of the window. The number of screws will depend on the Printer size.



CAUTION: We recommend that the last screw to be removed is one of the central screws. Take care when removing the last holding screw, that holds the Dryer Assembly as it could fall.

18. When all of the T-20 screws have been removed, you can remove the Dry Assembly from inside the Window.



NOTE: After installing the NEW Dryer Heater perform the following:

- "8.6 Heating Resistance resist" ⇒ page 171.
- Reset the life counter "4.8.3Heating Lamps" ⇒ page 201.

Curing Fans & Cover

Removal



WARNING! Switch off the printer and remove the power cable.



1. Remove the Left Cover ⇒ See page 325.
2. Remove the Left Curing Cover ⇒ See page 328.
3. Remove the Right Curing Cover ⇒ See page 330.
4. Disconnect the Curing Fans Cable from the left of the printer.
5. Disconnect the Left Window Sensor Cable.
6. Remove one T-20 screw from the left side of the Curing Module (screw closest to the printer).



7. Remove one T-20 screw from the top of the Left Curing Trim.



8. Remove one T-10 screw from the bottom of the Left Curing Trim.



9. Remove the Left Curing Trim.



10. Disconnect the Right Window Sensor Cable.



11. Remove one T-20 screw from the Right Curing Trim (screw furthest from the printer).



12. Remove one T-20 screw from the top of the Right Curing Trim.



13. Remove one T-10 screw from the bottom of the Right Curing Trim.



14. Remove the Right Curing Trim.

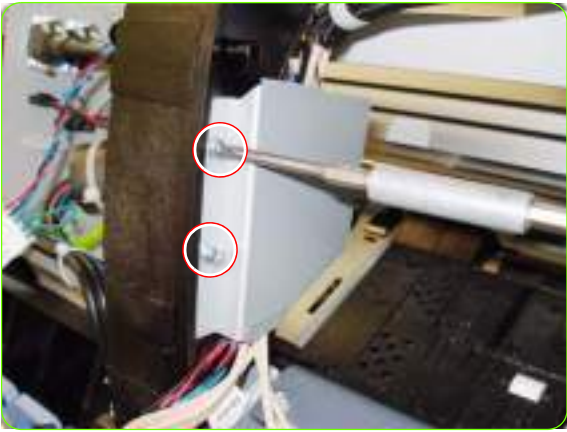

15. Remove two T-20 screws that secure the Left Cable Plate to the printer.



16. Remove the Left Cable Plate.



17. Push the cable of the Curing Fans back through underneath the left arch.



18. Leave the cable of the Curing Fans loose on the Curing Module.



19. Remove all the T-10 screws that secure the front of the Curing Fans Cover to the Printer.

Do not remove the screws that secure the Curing Grill to the Curing Module, these do not need to be removed.



20. Remove all T-20 screws from the top of the Curing Fans Assembly.



CAUTION: We recommend that the last screw to be removed is one of the central screws. Take care when removing the last holding screw, that holds the Curing Assembly as it could fall.



21. Remove the Curing Fans Cover.



22. Place the Curing Fans Cover on the floor or a flat surface.



23. Unroute the Fans cable from inside the Fans Cover.



24. Disconnect the Fans Cable.



25. Remove the Fans Cable from the clip in the Fans Cover.



26. Remove four T-20 screws from the Fans Assembly.



27. Remove the Fan from the Fan mounting.



28. Remove the Fan Assembly.

Curing IR Temperature Sensor & Fan

Removal



WARNING!: Switch off the printer and remove the power cable.

1. Remove the Left Cover ⇒ See page 325
2. Remove the Left Curing Cover ⇒ See page 328.
3. Remove the Right Curing Cover ⇒ See page 330.
4. Remove the Curing Fans Cover ⇒ See page 503.
5. Loosen two screws on the connector of the Curing IR Temperature Sensor cable, by hand or with a flat screwdriver.



6. Disconnect the Curing Temperature Sensor Cable.



7. Disconnect the cable of the Curing Temperature Sensor Fan.

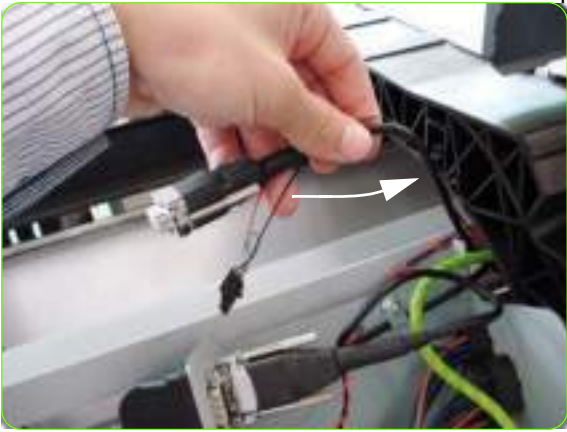

8. Push the cables of the Curing Temperature Sensor and Fan back through underneath the left arch.



9. Leave to one side the cables of the Curing Temperature Sensor and Fan.



10. Remove all the T-20 screws that secure the cables of the Curing Temperature Sensor and Fan to the front of the curing Module.



TIP: Not all of the cable clamps need to be removed, only those that hold the cables of the Curing Temperature Sensor and the Fan.

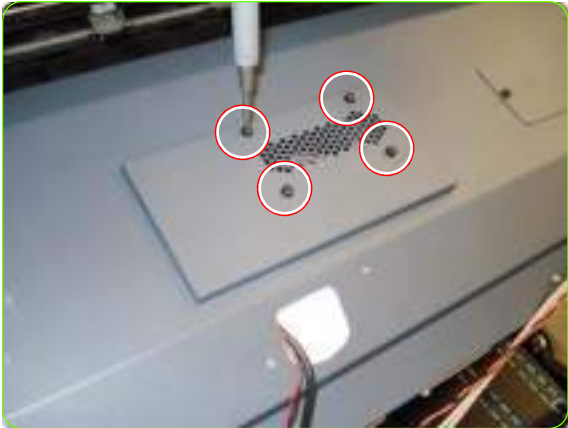

11. Remove only the cables of the Curing Temperature Sensor and the Fan from the cable clamps. The cables of the curing heater and right window sensor can stay in the cable clamps.

12. Remove four T-10 screws securing the cover of the Curing Temperature Sensor.

13. Remove the cover.

14. Pull off the ferrite clamp from the Curing Cover.



15. Slide the black plastic holder to the left.



16. Remove the Curing Temperature Sensor Fan from the black plastic holder.



17. Remove two thin nuts securing the Curing Temperature Sensor to the black plastic bracket.



18. Slide out the Curing IR Temperature sensor.



19. Remove the Curing Temperature Sensor Fan through the hole in the Curing cover.

20. Remove the Curing Temperature Sensor through the hole in the Curing cover.

Installation



1. When installing the Curing Temperature Sensor fan, it is important that the label of the fan is not visible.



2. In this example the fan is correctly installed.



NOTE: After installing the NEW Curing IR Temp sensor & Fan perform the following:

- Reset the life counter "4.8.2 Reset Curing Sensor" ⇒ page 201.

Curing Heaters

Removal



WARNING! Switch off the printer and remove the power cable.



1. Remove the Left Cover ⇒ See page 325.
2. Remove the Left Curing Cover ⇒ See page 328.
3. Remove the Right Curing Cover ⇒ See page 330.
4. Remove the Curing Fans Cover ⇒ See page 503.
5. Loosen two screws on the connector of the Curing IR Temperature Sensor cable, by hand or with a flat screwdriver.

6. Disconnect the Curing Temperature Sensor Cable.

7. Disconnect the cable of the Left Windows Lock Sensor.

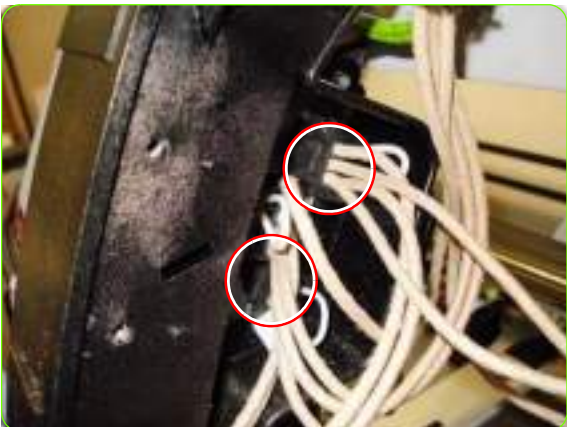
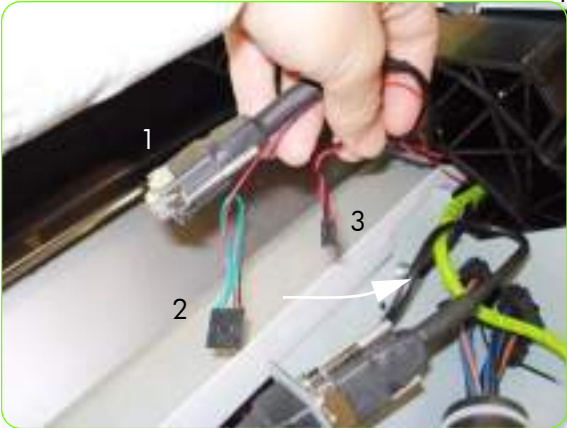
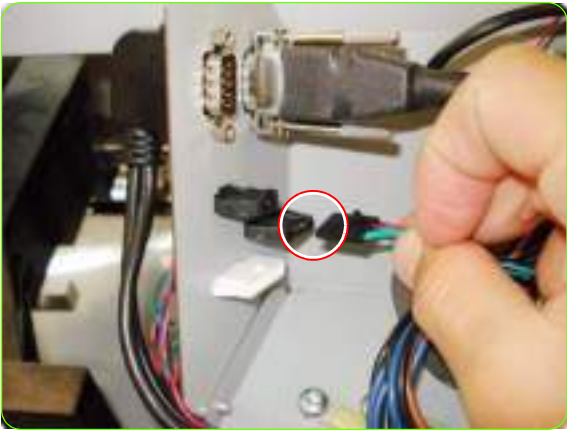

8. Disconnect the cable of the Curing Temperature Sensor Fan.
9. Push the cables of the Curing Temperature Sensor (1), the Sensor Fan (2) and the Left Windows Lock Sensor (3) back through underneath the left arch.
10. Disconnect the Curing Heater Cables from the left side (upper and lower connectors).
11. Remove one T-15 screw that secures the Output Roller to the right side of the Curing module, and remove the roller.



12. Slide the Output roller from the pin located on the left side of the curing Module.



13. Remove the Output roller.



14. Remove the Electrical Block Cover by squeezing the holding pins together and sliding it off.



15. Loosen three screws on the Electrical Block with a flat end screw driver.



16. Remove the three cables from the Electrical Block. Take care not to lose the holders underneath the terminal cables.



17. Remove one T-20 screw from a cable clamp that secures the heater cables.



18. Remove the cable clamp from around the heater cables.



19. Remove two T-10 screws from the cover of the Curing Thermal Switch.



20. Pull out the cover of the Curing Thermal Switch.



21. The Curing Thermal Switch is located on the underside of the cover. Disconnect the connector shown.



22. Remove both together the Cover and the Curing Thermal Switch.



23. Remove the cable shown from inside the Curing Module.

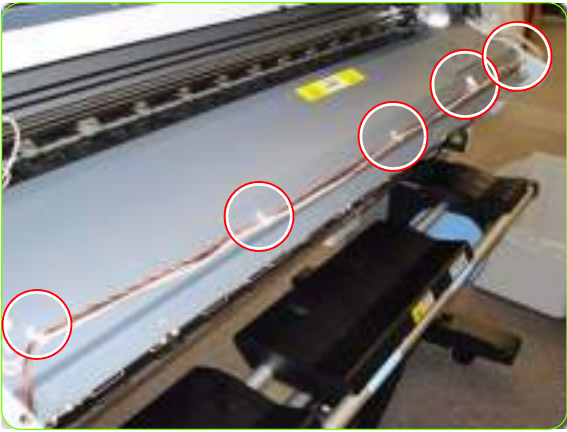

24. Remove all the T-20 screws from the cable clamps that secure cables to the front of the Curing Module. The number of cable clamps will depend of the version of the Printer.

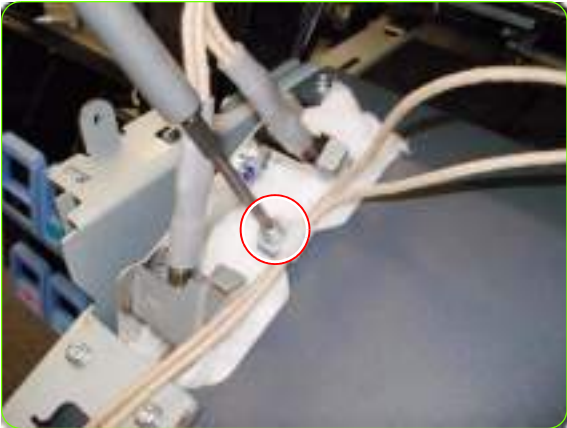

25. Remove one cable clamp on the left side of the curing Module.



26. Remove two T-10 safety grounding screws from the right side of the Heaters.
To ensure the electrical safety of the printer, it is critical that these screws are reinstalled at the installation.



27. Remove two T-10 screws from the left side of the Heaters.

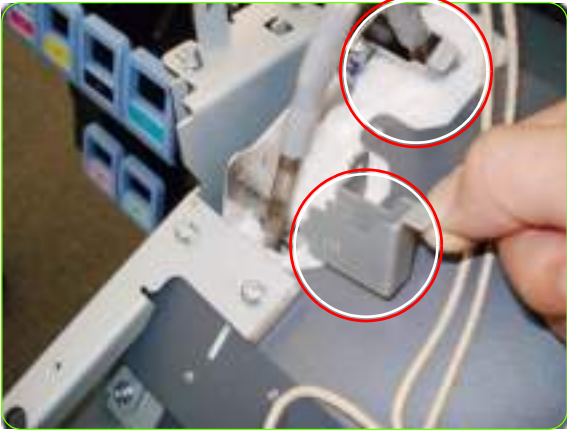

28. Remove the two holding brackets on the left side of the resistors.



29. Remove one T-20 screw from the left of the Curing Module.



30. Remove two T-20 screws from the right side of the Curing Module.



31. Remove one T-20 screw from the top right of the Curing Module.



32. Remove the Curing Module by lifting off the left and right locating pins.



33. Turn upside down and place on a flat even surface.



NOTE: When placing on the flat surface take care not to damage the terminals of the Heaters.



34. Remove all the T-10 screws that secure the sections of Curing Heater Grills to the Curing Module.

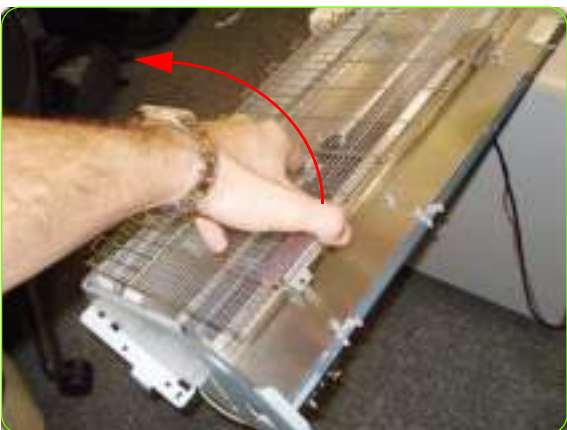

35. Remove the Heater Grills by lifting up the free end and removing.



36. Remove all T-15 screws that secure the heater holders to the Curing Module.



37. Twist the heater holders to remove them all.



NOTE: The Output Heater Holders are different to the Overdrive Heater Holders



38. Remove the left end of the Output Heater taking care not to damage the Isolation fiber.



39. Remove the right end of the Output Heater taking care not to damage the Isolation fiber.



40. Be careful when removing the end of the Output heater cable as there is a connector on the end, and this could damage the isolation fiber.



41. Remove the Overdrive Heater taking care not to damage the Isolation fiber.



42. Remove the other end of the Overdrive Heater

Installation

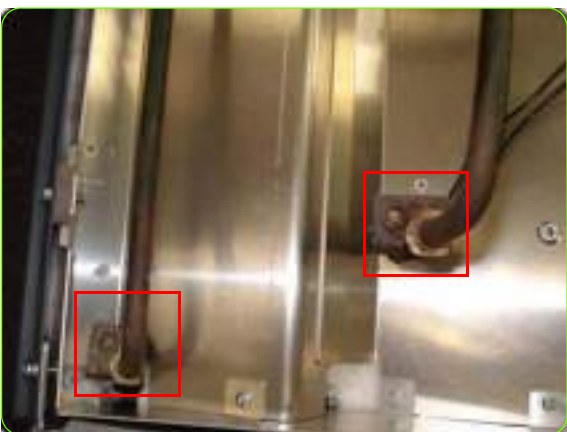

1. The ends of the two types of Curing Heaters are different to avoid incorrectly installing them. If the Heaters are installed swapped over, this will trigger a system error.



NOTE: After installing the NEW Curing Heaters perform the following:

- Reset the life counter "4.8.1 Reset Curing Lamps" ⇒ page 201.

Curing Module & Curing Fans Assembly

Removal



WARNING! Switch off the printer and remove the power cable.



1. Remove the Left Cover ⇒ See page 325.
2. Remove the Left Curing Cover ⇒ See page 328.
3. Remove the Right Curing Cover ⇒ See page 330.
4. Loosen two screws on the connector of the Curing IR Temperature Sensor cable, by hand or with a flat screwdriver.

5. Disconnect the Curing Temperature Sensor Cable.

6. Disconnect the cable of the Left Windows Lock Sensor.



7. Disconnect the cable of the Curing Fans.



8. Disconnect the cable of the Curing Temperature Sensor Fan.



9. Remove two T-20 screws from the left cable plate.



10. Remove the Left Cable Plate.

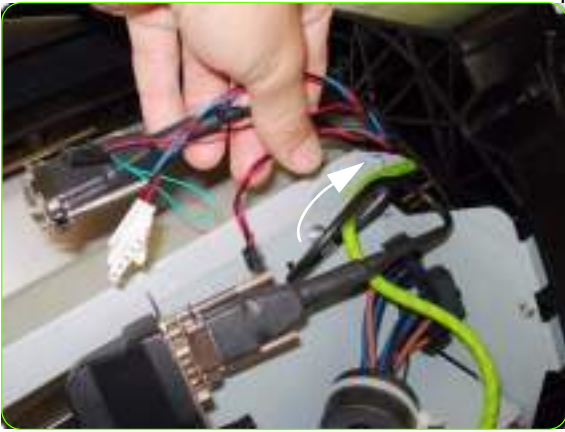

11. Push all the cables through the left arch and out the other side.



12. Disconnect the Curing Heater Cables from the left side (upper and lower connectors).



13. Disconnect the Left Window Sensor Cable

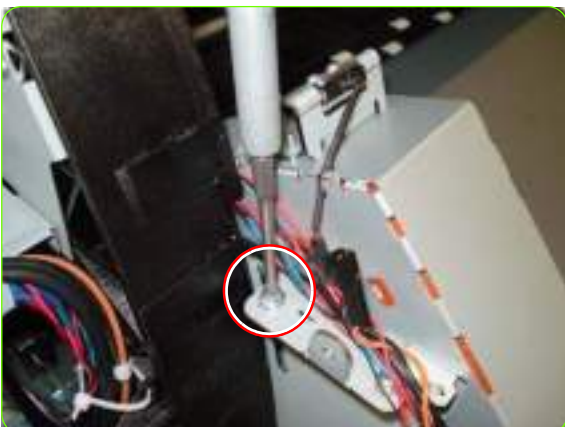

14. Remove one T-20 screw from the left side of the Curing Module (screw closest to the Printer).



15. Remove one T-20 screw from the top of the Left Curing Trim.



16. Remove one T-10 screw from the bottom of the Left Curing Trim.



17. Remove the Left Curing Trim.



18. Disconnect the Right Window Sensor Cable.



19. Remove one T-20 screw from the Right Curing Trim (screw furthest from the printer).



20. Remove one T-20 screw from the top of the Right Curing Trim.



21. Remove one T-10 screw from the bottom of the Right Curing Trim.



22. Remove the Right Curing Trim.



23. Remove one T-15 screw that secures the Output Roller to the right side of the Curing module, and remove the roller.



24. Slide the Output roller from the pin located on the left side of the curing Module.



25. Remove the Output roller.



26. Remove two T-20 screws from the right side of the Curing Module.



27. Remove one T-20 screw from the top right of the Curing module.

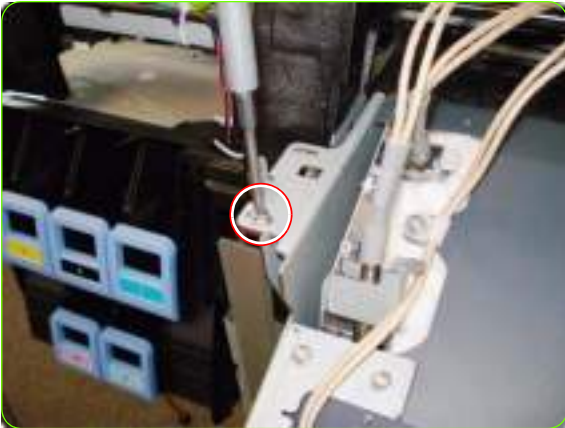

28. Remove one T-20 screw from the left of the Curing module.



29. Remove the Curing Module by lifting off the left and right locating pins.



30. Turn upside down and place on a flat even surface.



NOTE: When placing on a flat surface take care not to damage the terminals of the Curing Heaters.

Installation

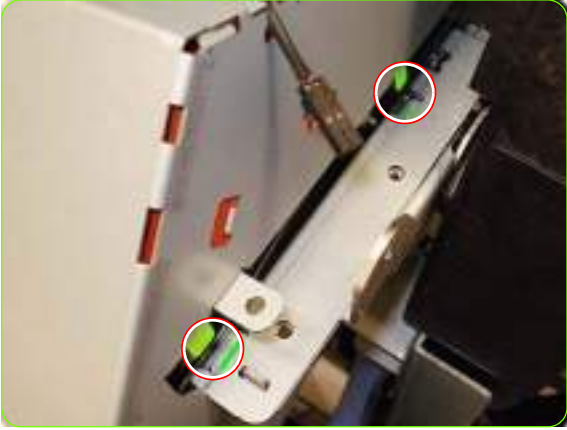

1. When installing the Left and Right Curing Trims back onto the printer, ensure they are installed into the alignment holes, located on the sides.

Output Platen

Removal



WARNING! Switch off the printer and remove the power cable.



1. Remove the Left Cover ⇒ See page 325.
2. Remove the Left Curing Cover ⇒ See page 328.
3. Remove the Right Curing Cover ⇒ See page 330.
4. Remove the Curing Module & Curing Fans⇒ See page 525.
5. Remove one T-20 screw from the right side of the Output Platen.
6. Remove one T-20 screw from the left side of the Output Platen.
7. Remove one T-10 screw from below left of the Output Platen.



8. Remove one T-15 screw + washer from below right of the Output Platen.



9. Remove one t-10 screw from below the Output platen in the middle.



10. Lift the Output Platen off the locating pins and remove.

Curing Holders

Removal



WARNING! Switch off the printer and remove the power cable.



1. Remove the Right Cover ⇒ See page 319.
1. Remove the Curing Module ⇒ See page 525.
2. Remove the Output Platen ⇒ See page 533.
3. Cut the cable clamp to release the bundle of cables on the front of the left arch.

4. Remove one T-20 screw that secures the Left Curing Holder to the left arch.

5. Remove two T-15 screws from the Left Curing Holder.

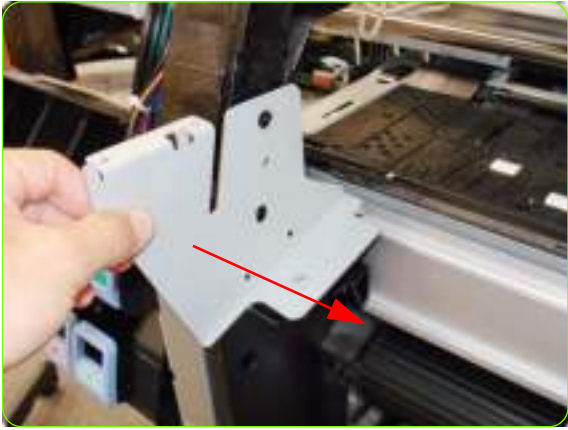

6. Remove the Left Curing Holder.

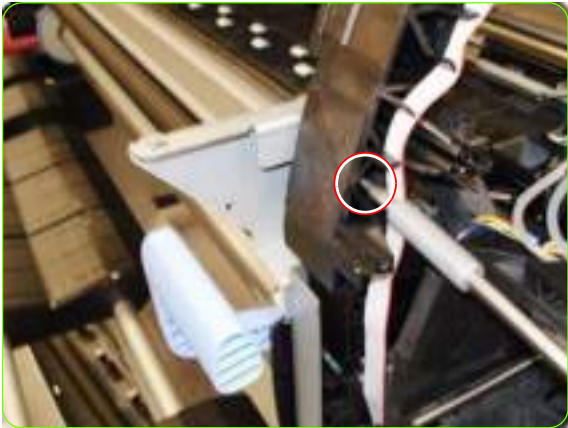

7. Remove one T-20 screw that secures the right Curing Holder to the right arch.



8. Remove one T-10 screw from the Right Curing Holder.



9. Remove two T-15 screws from the Right Curing Holder.



10. Remove the Right Curing Holder

Center Platen

Removal



WARNING!: Switch off the printer and remove the power cable.

1. Remove the Right Cover ⇒ See page 319.
2. Remove the Left Cover ⇒ See page 325.
3. Remove the Top Cover ⇒ See page 334.
4. Remove the Service Station ⇒ See page 364.
5. Remove the Rear Cover ⇒ See page 332.
6. Squeeze the corners of the OMAS Access Cover release it from the bottom of the printer.



7. Remove the OMAS Access Cover from the printer.

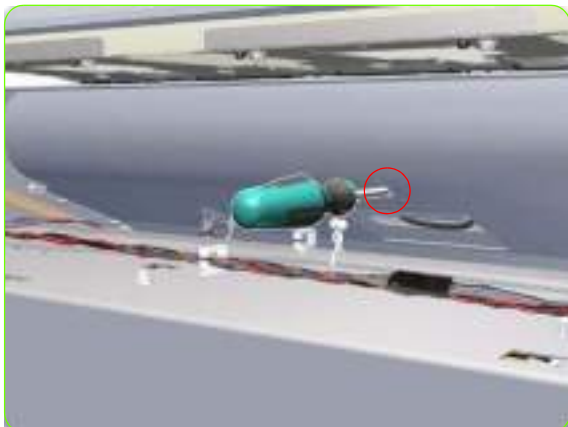

8. Insert the T-20 thin bladed torx screwdriver (supplied with the replacement OMAS) into the access hole at the rear of the printer.



9. Loosen approximately two turns the T-20 screw which secures the OMAS horizontally to the printer.



10. From the bottom of the printer, loosen approximately two turns the T-20 screw which secures the OMAS vertically to the printer.



11. Carefully lower the OMAS from the printer as far as you can with the large ribbon cable still connected.

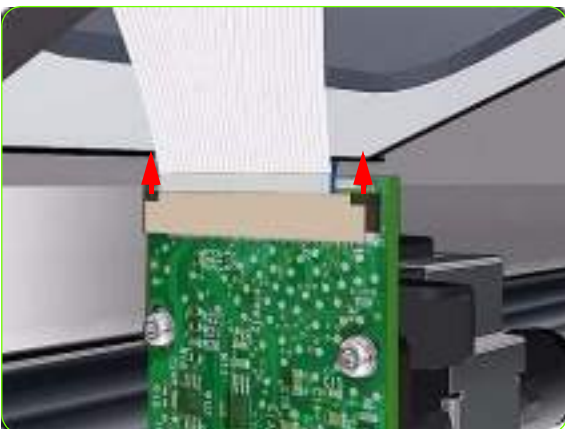

12. Release the two locking clips of the large ribbon cable connector.

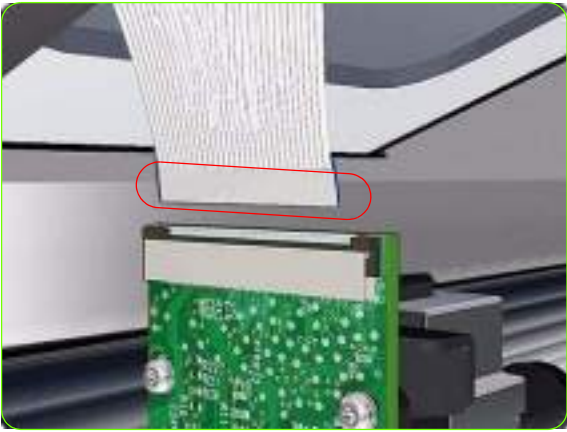

13. Disconnect the large ribbon cable from the OMAS.



14. Remove the OMAS Sensor from the Printer.



15. Remove one T-15 screw (**Type P**) that secures the Center Platen Gear.



16. Remove the Center Platen Gear from the Printer.



17. Remove one T-15 screw that secures the small Gear.



18. Remove the small Gear from the Printer.



19. Remove the two small Platen Gears by releasing the clips.



20. Remove two T-20 screws (**Type Q**) that secure the Gear Bracket.

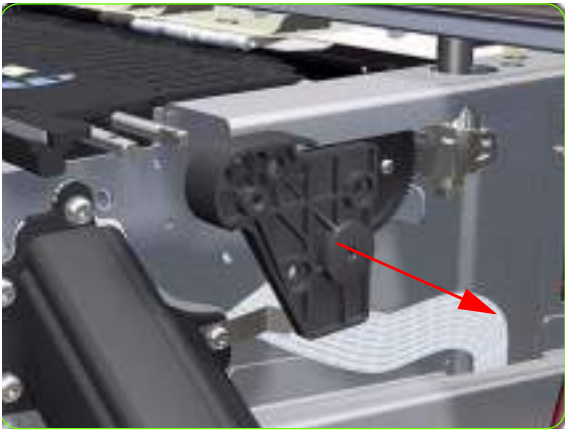

21. Remove the Gear Bracket from the Printer.



22. Move the Carriage Assembly fully to the right.

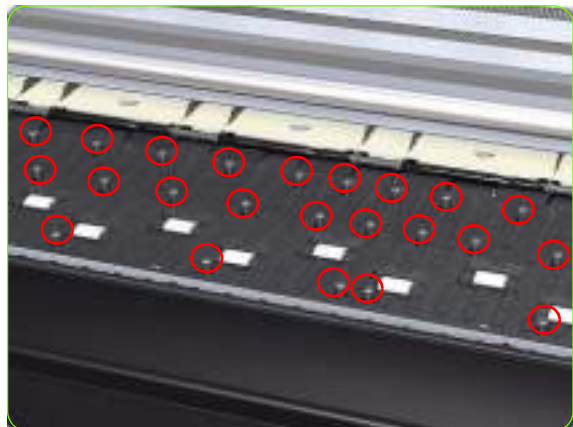

23. Remove all the T-10 screws (**Type C**) that secure the Center Platen:

- 80 T-10 screws for the 42-inch model
- 116 T-10 screws for the 60-inch model.

24.



25. Remove the Center Platen from the Printer.

OMAS Attachment Screws Completely Removed during Center Platen Removal

26. Completely remove OMAS from the Printer ⇒ See page 424.

Installation of the Foam

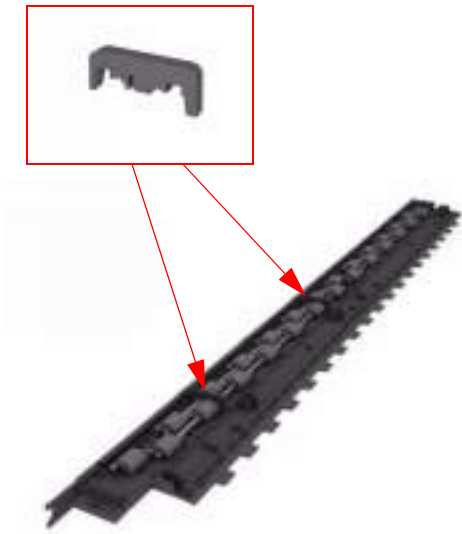

1. Make sure you take note of the positions of the Foams located underneath the center Platen.



NOTE: When reinstalling the parts, make sure you apply the grease (included with the support part) to the gears.

NOTE: After installing the NEW Center Platen, make sure you perform the following Service Calibration:

- Paper Advance Calibration ⇒ Chapter 5.



1. Install the Center Platen.
2. Position the Attachment Screw Retainer on the OMAS and secure it with the T-8 attachment screw provided with Center Platen.

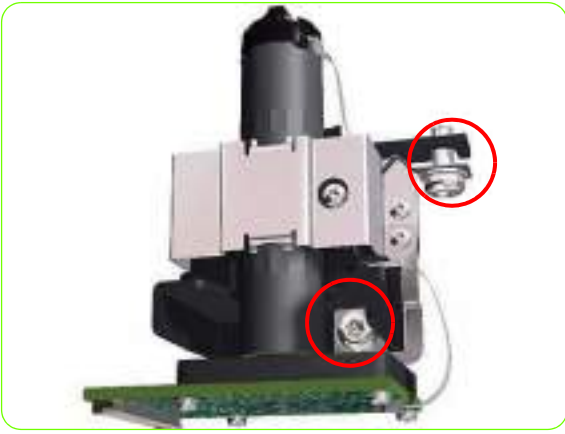

3. Verify that the two T-20 attachment screws are correctly positioned in the Attachment Screw Retainer.

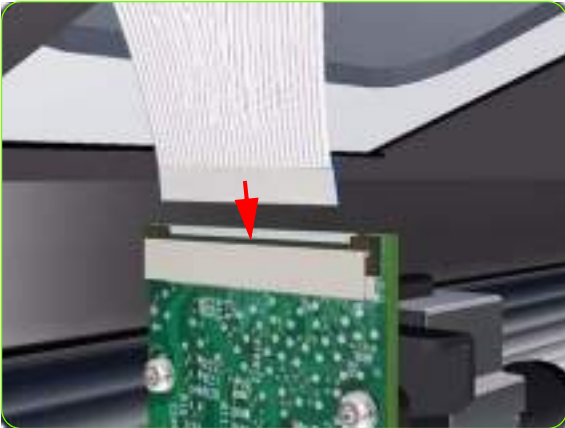

4. Position the OMAS under the Printer and connect the large ribbon.

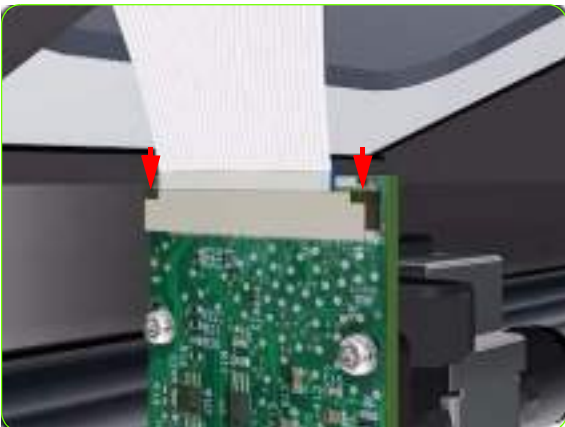

5. Lock the clips of the large ribbon cable connector.



6. Fully tighten the T-20 vertical attachment screw.



7. While installing the OMAS, take care not to trap the cable of the TOMAS.



8. Carefully push the OMAS fully up into its mounting so it protrudes slightly (approximately 0.1 mm) above the Center Platen. To ensure the OMAS is correctly positioned, slide a sheet of paper over the Platen Ribs until it is stopped by the OMAS. This ensures the OMAS is protruding slightly above the platen.



CAUTION: Make sure the OMAS is pushed completely up into its mounting or you will encounter an error during the OMAS calibration because it will not be able to focus on the paper.



9. If the paper is not stopped by the OMAS, repeat the previous steps to ensure the OMAS is pushed fully up into its the mounting.

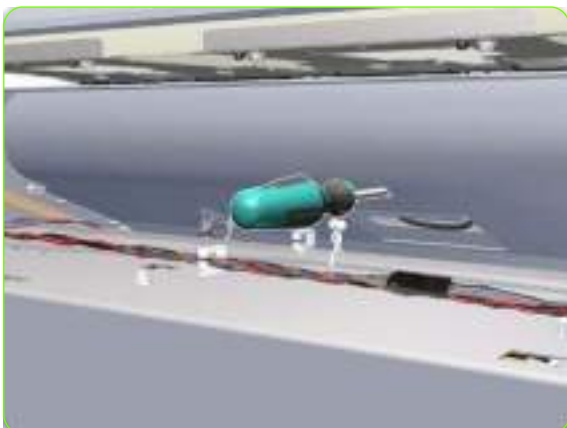

10. Insert the T-20 thin bladed torx screwdriver into the access hole at the rear of the printer.



11. Fully tighten the T-20 horizontal attachment screw which secures the OMAS to the printer.

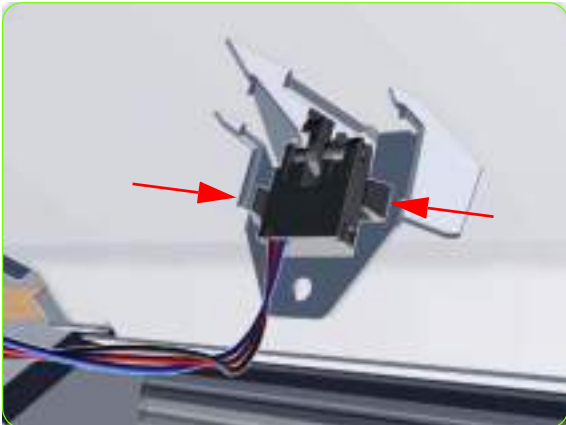

12. Clip the Media Sensor to the Center Guide.



13. Install the holder of the Media Sensor.



14. Install one T-10 screw into the Media sensor holding bracket.



15. Clip the OMAS access cover back into place by sliding one edge of the cover into the slot and then applying enough pressure to it so you can clip it into the other slot.
16. Calibrate the following:
 - 1.3.5 OMAS ⇒ See page 189.
 - 5.3.1 Paper Advance Calibration ⇒ See page 201.

Cartridge Tray

Removal



WARNING!: Switch off the printer and remove the power cable.



1. Release the Tray Lever of the required color and pull out the Tray.



2. Remove the Ink Cartridge if installed.



3. Press down on the Tray clip.



4. Pull the Tray completely out of the Printer.



NOTE: Note that each Cartridge Tray is different even though they look very similar. When selecting the Cartridge Tray from the Support Part (it contains eight Cartridge Trays), choose the Tray that exactly matches the one that you have just removed.

Input Roller

Removal



WARNING!: Switch off the printer and remove the power cable.

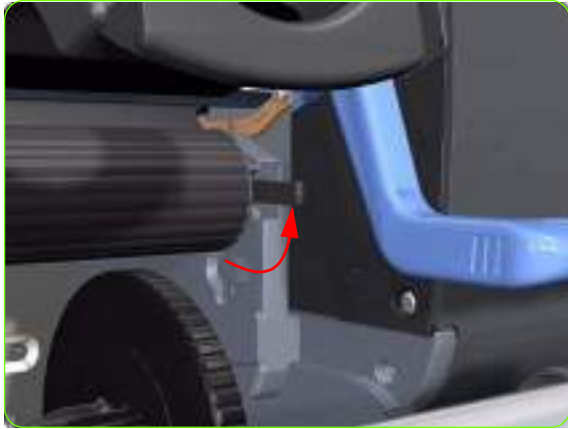

1. Raise the right lever to release the right hand end of the Input Roller.



2. Pull out the right hand end of the Input Roller from the Printer.



3. Move the Input Roller to the right to disengage it from the Printer.



4. Remove the Input Roller from the Printer.

Output Roller

Removal



WARNING! Switch off the printer and remove the power cable.



1. Remove the Right Curing Cover ⇒ See page 328.
2. Remove one T-15 screw from the left side of the Output Roller, and remove the Roller.

Printhead Maintenance Cartridge Door

Removal



WARNING! Switch off the printer and remove the power cable.



1. Open the Printhead Maintenance Cartridge Door.



2. Unclip and remove the Printhead Maintenance Cartridge Door from Right Cover.

Printhead Maintenance Cartridge Door Sensor

Removal



WARNING!: Switch off the printer and remove the power cable.

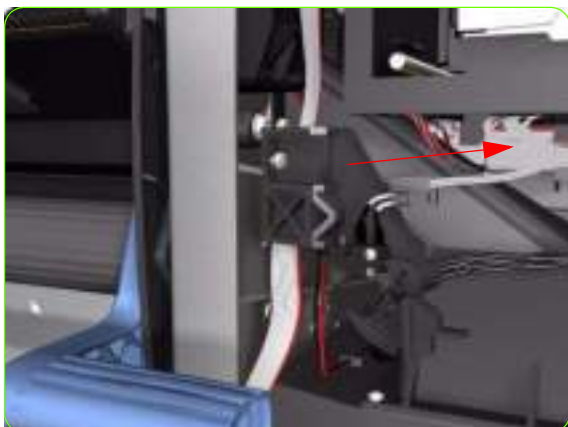
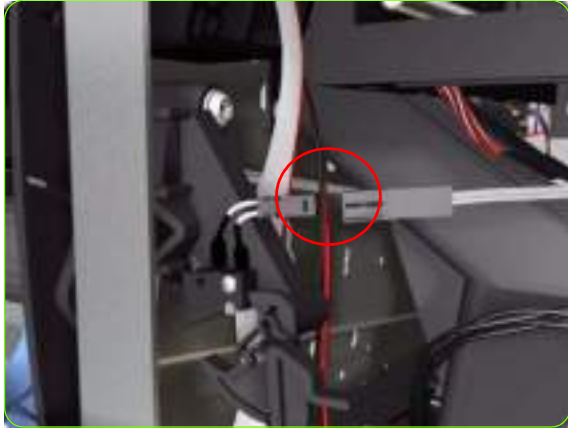

1. Remove the Right Cover ⇒ See page 319.
2. Disconnect the Printhead Maintenance Cartridge Door Sensor cable.
3. Release one T-10 screw the attaches the Printhead Maintenance Cartridge Door Sensor assembly to the printer.
4. Remove the Printhead Maintenance Cartridge Door Sensor assembly from the printer.

Media Sensor

Removal



WARNING! Switch off the printer and remove the power cable.

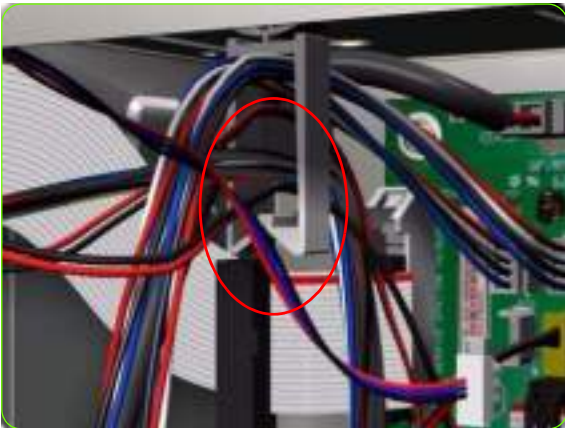

1. Remove the Rear Cover ⇒ See page 332.
2. Remove the Right Connector Cover ⇒ See page 341.
3. Disconnect the Media Sensor cable from the Interconnect PCA.
4. Release the Media Sensor cable from the clip located on the Electronics Module.
5. Remove one T-10 screw from the Media sensor holding bracket.
6. Remove one T-10 screw from the Media sensor holding bracket.

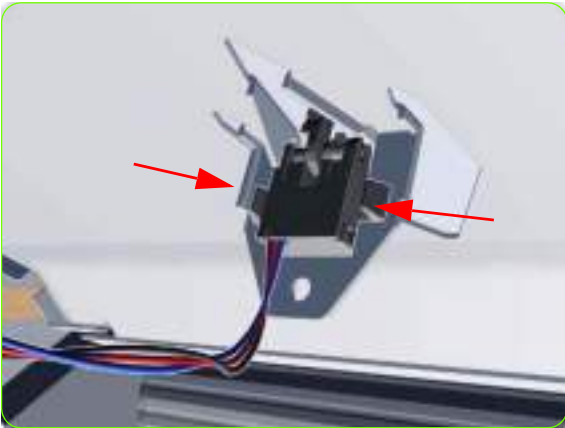
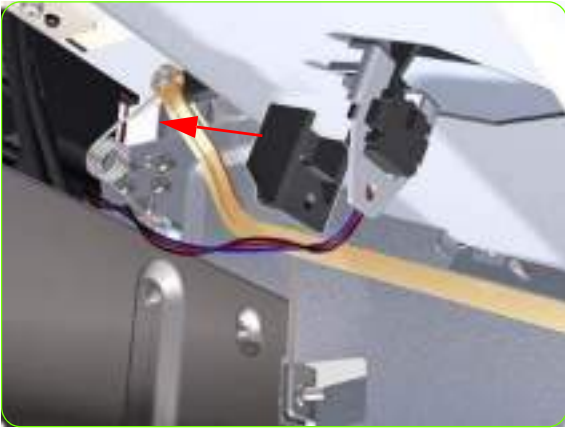

7. Remove the holder of the Media Sensor.

8. Unclip the Media sensor from the platen underside.

9. Pull the cable and connector through the mounting hole and remove the Media Sensor from the Printer.

Encoder Disc and Sensor

Removal



WARNING! Switch off the printer and remove the power cable.



CAUTION: Please handle the Encoder Disc very carefully since any finger prints, scratches or stains could cause the Printer to malfunction.

1. Remove the Left Cover ⇒ See page 325.
2. Remove:
 - For the 42-inch model, the Left Connector Cover ⇒ See page 343.
 - For the 60-inch model, the Electronics Module Extension ⇒ See page 344.
3. Remove the Ink Supply Station ⇒ See page 388.
4. Disconnect the Encoder Sensor cable from the PrintMech PCA.

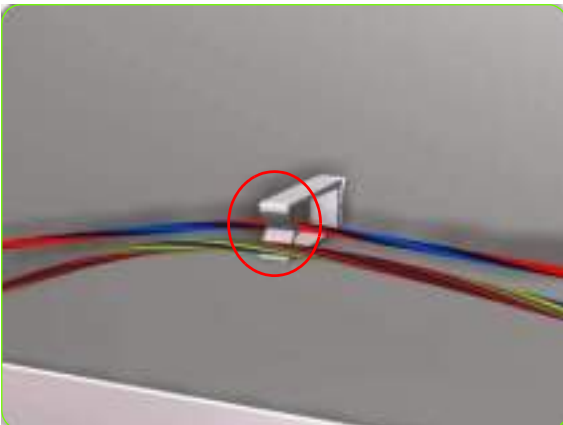
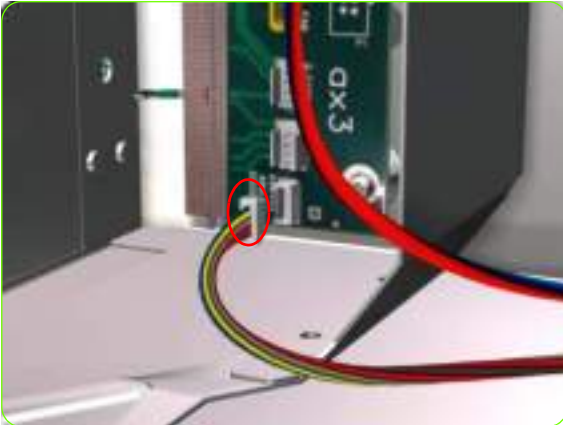

5. Release the Encoder Sensor cable from the clip located on the Electronics Module.

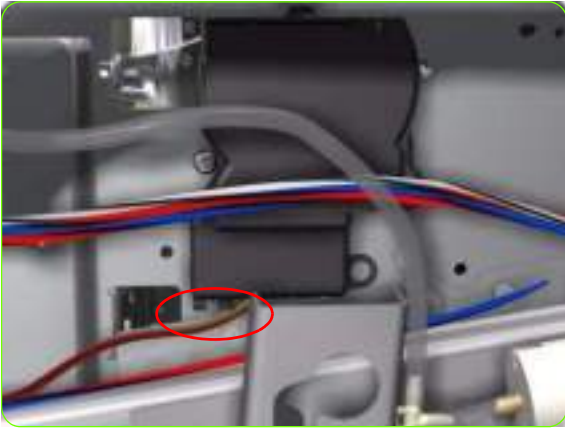

6. Release the Encoder Sensor cable from the clip located on the Encoder Disc Cover.

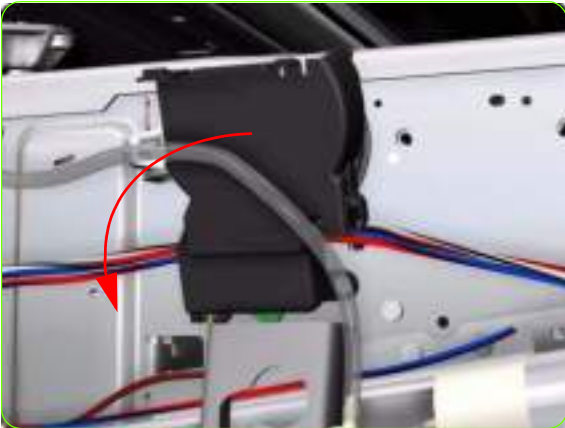

7. Unclip the Encoder Disc Cover and remove from the Printer.



8. Remove one T-8 screw (**Type D**) that secures the Encoder Sensor to the Chassis.

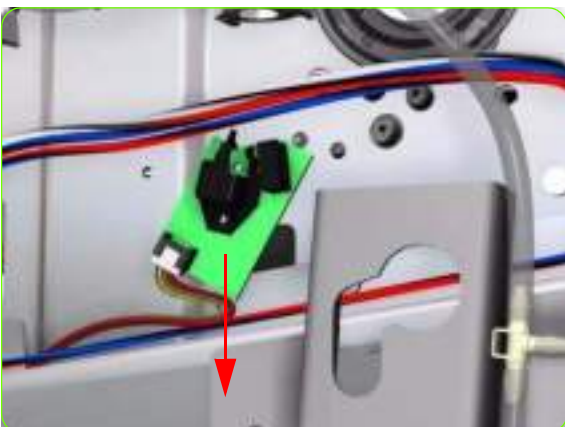

9. Remove the Encoder Sensor from the Printer.

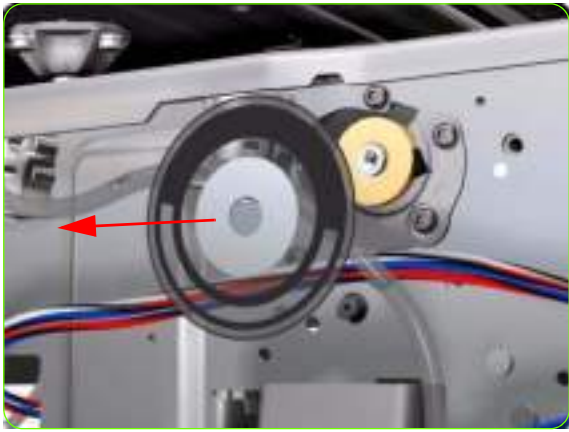

10. Carefully peel the Encoder Disc from the Drive Roller.

Media Lever Assembly

Removal



WARNING!: Switch off the printer and remove the power cable.

1. Remove the Right Cover ⇒ See page 319.
2. Remove the Rear Cover ⇒ See page 332.
3. Raise the Media Lever.

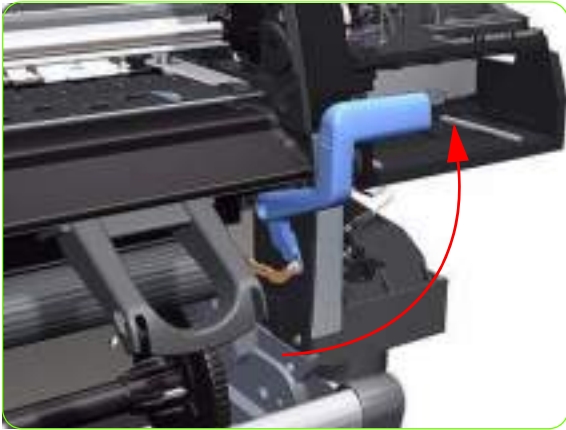

4. Remove one T-15 screw (**Type F**) that secures the Linkage to the Spring.



5. Remove the Linkage from the Spring.





6. Remove one T-20 screw (**Type A**) that secures the Spring to the Spacer.



7. Remove the Spring and plastic washer.



8. Raise the Media Lever to gain access to the linkage attachment screw.



9. Remove one T-15 screw (**Type F**) that secures the Media Lever to the Linkage.

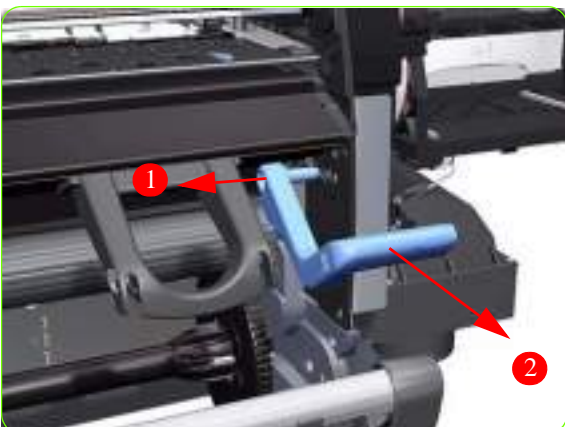
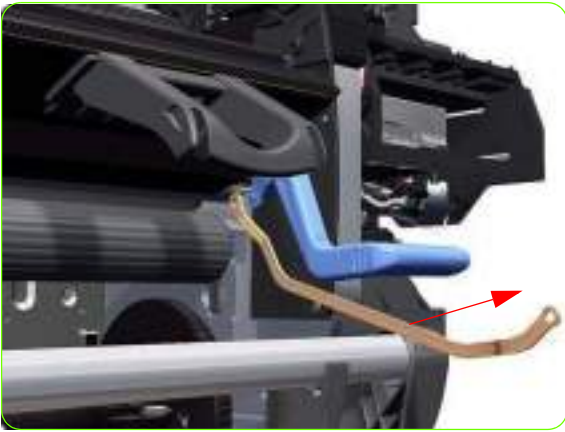

10. Remove the Media Lever Linkage from the Printer.

11. Remove one T-20 screw (**Type O**) that secures the Media Lever to the Right Trim.

12. Raise the Media Lever.

13. Remove the Media Lever from the Printer.

Media Lever Sensor

Removal



WARNING! Switch off the printer and remove the power cable.



1. Remove the Right Cover ⇒ See page 319.
2. Remove the Right Trim ⇒ See page 322.
3. Remove the Right Connector Cover ⇒ See page 341.
4. Remove the Output Platen ⇒ See page 533.
5. Disconnect the Media Lever Sensor cable from the Interconnect PCA.
6. Unroute the Media Lever Sensor cable from the cable clamp.
7. Release the Media Lever Sensor Cable from the three clips on the Vacuum Fan.

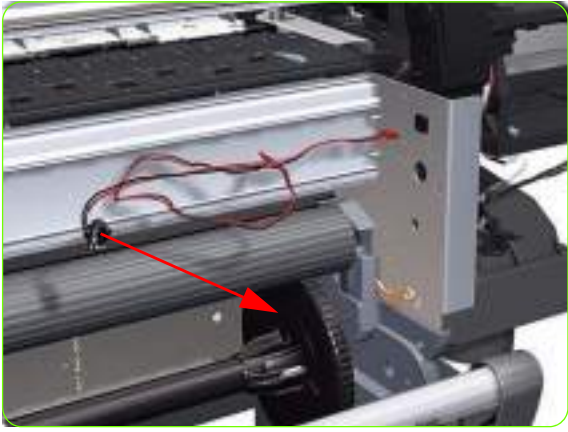

8. Remove the Media Level Sensor from the Printer.

Pinchwheel Assembly

Removal



WARNING! Switch off the printer and remove the power cable.

1. Remove the Right Cover ⇒ See page 319.
2. Remove the Rear Cover ⇒ See page 332.
3. Remove the Service Station ⇒ See page 364.
4. Raise the Media Lever.



5. Remove one T-20 screw that secures the Linkage to the Spring.



6. Disconnect the linkage from the Pinch Wheel cam-arm.



7. Disconnect the spring from the Pinch Wheel cam-arm.



8. Remove one T-20 screw that secures the Cam to the Cam Lever.



9. Insert a plastic stud in to each Pinchwheel Subassembly (the Plastic Studs can be found in the replacement Pinchwheel Assembly kit).



10. For the 60-inch model, remove one T-20 screw that secures the attachment plate to the center Pinchwheel Subassembly.

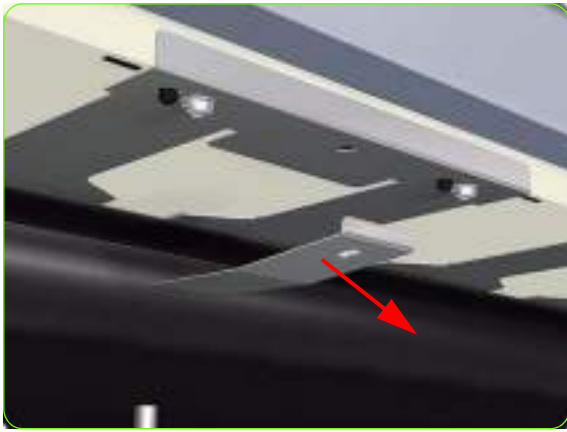

11. For the 60-inch model, remove the attachment plate from the center Pinchwheel Subassembly.

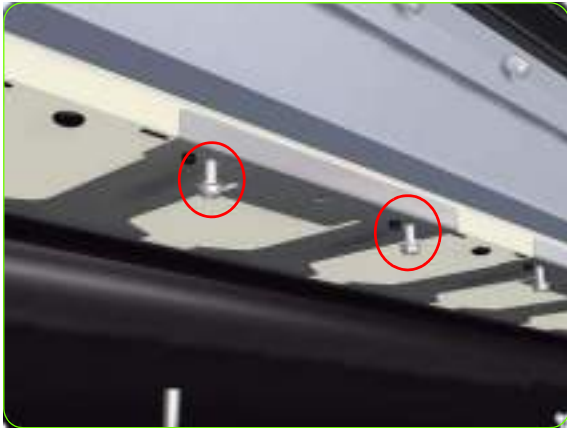

12. Remove two T-20 screws (**Type M**) from each Pinchwheel Subassembly (a 90 degree angle screwdriver is included with the replacement Pinchwheel Assembly).



NOTE: The illustration shows the 60-inch model center Pinchwheel Subassembly.



13. Remove the complete Pinchwheel Assembly (including the Cam and Cam Lever) from the Printer.



NOTE: Before installing the NEW Pinchwheel Assembly, insert the plastic studs in to each Pinchwheel subassembly. This will make it easier to install the complete Pinchwheel Assembly.

Individual Pinchwheel Rollers

Removal



WARNING!: Switch off the printer and remove the power cable.



1. Open the Window ⇒ See page 325.



2. Raise the Media Lever.

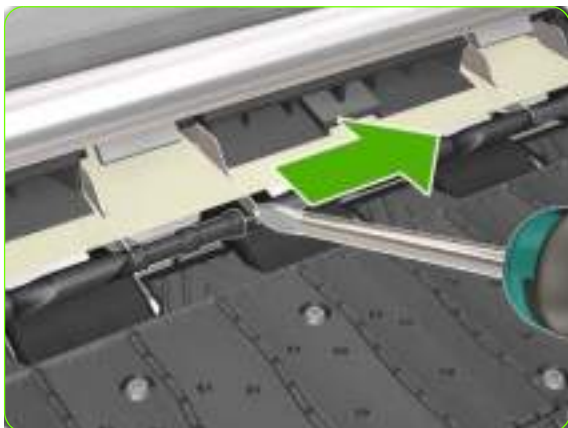

3. Going from right to left use a screw driver to push apart all the pins that secures the Inter-Pinchwheel roller.

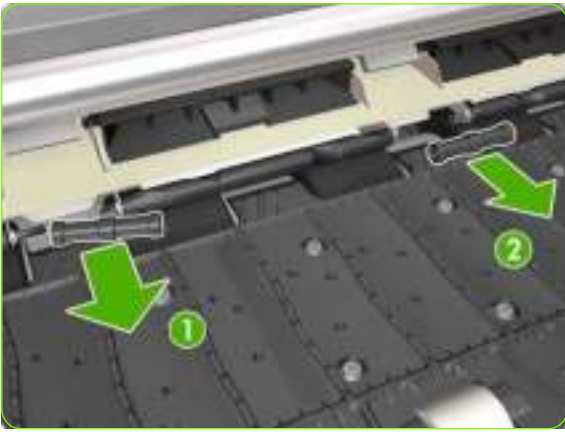

4. Remove the two inter-Pinchwheel rollers from both sides of the Pinchwheel. Remove first the left one (1) and then the right one(2). You need to go from right to left, doing this until you reach the individual Pinchwheel that you need to remove

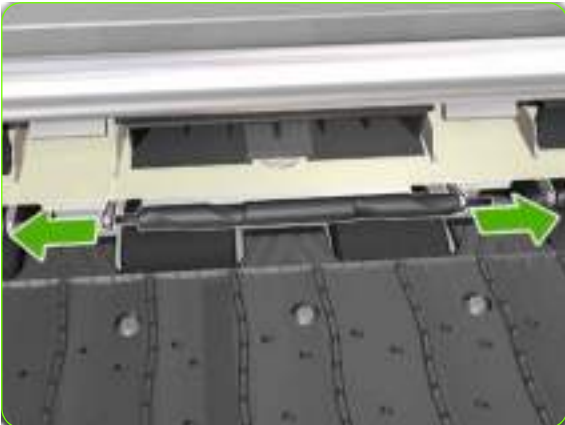

5. When you have reached the individual Pinchwheel roller, push apart the metal part that secures the Pinchwheel roller.



6. Pull out the individual Pinchwheel roller.

Installation of the Drive Roller



1. When installing the new Pinchwheel rollers, make sure they are the new type.

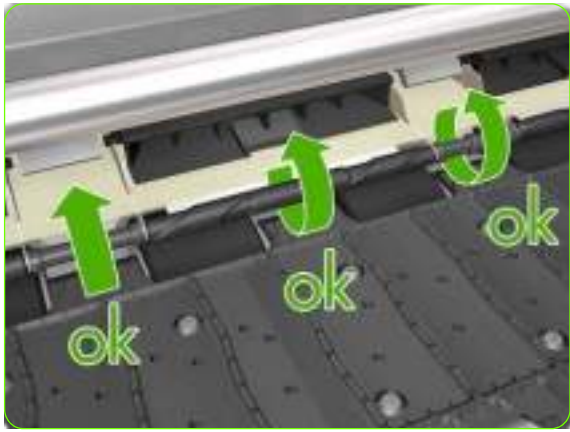

2. When the new Pinchwheel roller has been installed, check that the rollers move freely.

Center Guide

Removal



WARNING! Switch off the printer and remove the power cable.

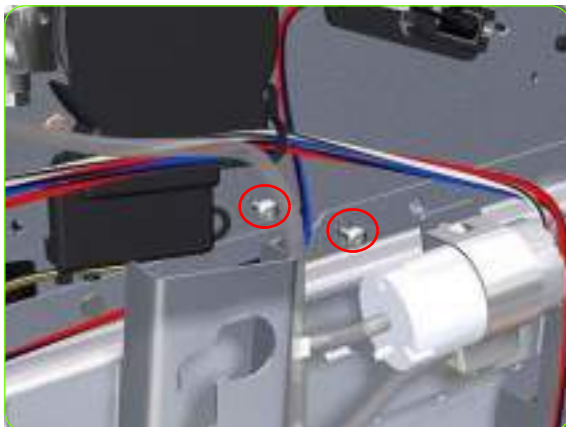
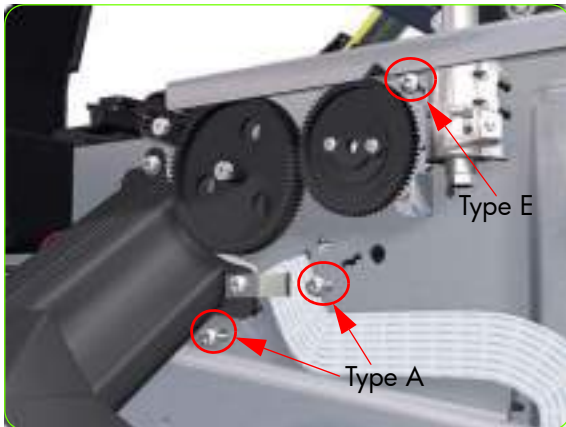

1. Remove the Right Cover ⇒ See page 319.
2. Remove the Left Cover ⇒ See page 325.
3. Remove the Primer Assembly ⇒ See page 355.
4. Remove the Right Connector Cover ⇒ See page 341.
5. Remove the Electronics Module ⇒ See page 483.
6. Remove the Service Station ⇒ See page 364.
7. Remove the Ink Supply Station ⇒ See page 388.
8. Remove the Media Sensor ⇒ See page 563.
9. Remove one T-15 screw (**Type E**) and two T-20 screws (**Type A**), that secure the Center Guide, from the right hand side of the Printer.
10. Remove two T-15 screws (**Type E**), that secure the Center Guide, from the left hand side of the Printer.

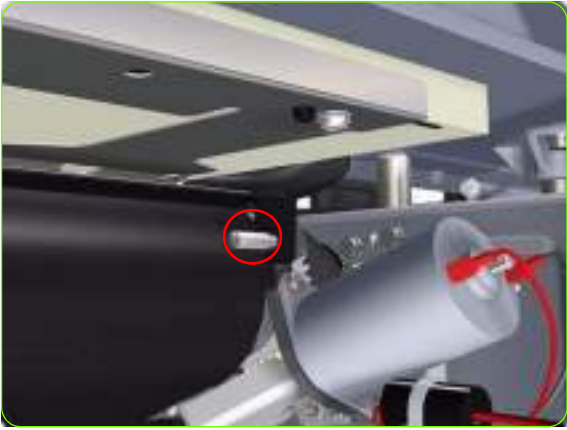

11. Remove one T-15 screw (**Type S**), that secures the Center Guide, from underneath the Printer.



12. Remove the Center Guide from the Printer.

Drive Roller

Removal



WARNING! Switch off the printer and remove the power cable.

1. Remove the Right Cover ⇒ See page 319.
2. Remove the Left Cover ⇒ See page 325.
3. Remove the Right Connector Cover ⇒ See page 341.
4. Remove:
 - For the 42-inch model, the Left Connector Cover ⇒ See page 343.
 - For the 60-inch model, the Electronics Module Extension ⇒ See page 344.
5. Remove the Service Station ⇒ See page 364.
6. Remove the Ink Supply Station ⇒ See page 388.
7. Remove the Media-Axis Motor ⇒ See page 422.
8. Remove the Encoder Disc and Sensor ⇒ See page 557.
9. Remove the Media Lever Assembly ⇒ See page 560.
10. Remove the Media Sensor ⇒ See page 563.
11. Remove the Center Guide ⇒ See page 571.
12. Remove two T-10 screws that secure the Drive Roller Gear.

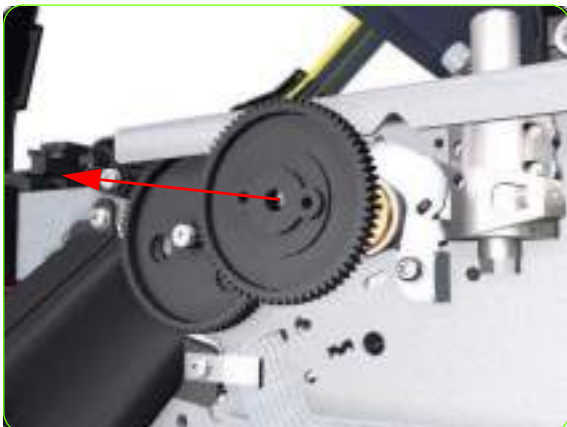

13. Remove the Drive Roller Gear from the Printer.



14. Remove one T-20 screw (**Type B**) that secures the cover on the right hand side of the Printer.

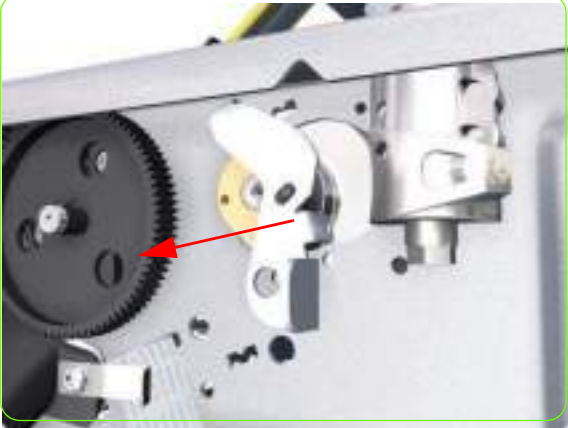

15. Remove the Cover.

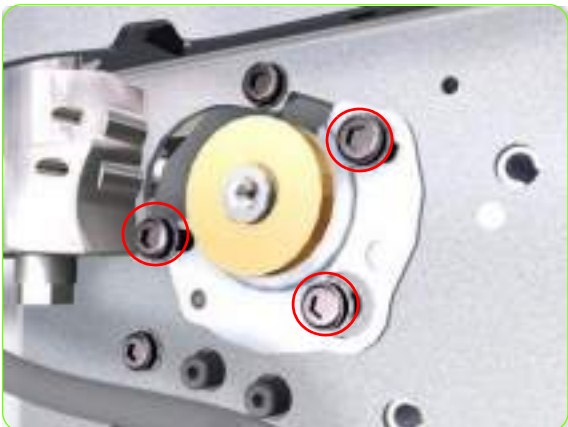

16. Remove three T-20 screws that secure the cover on the left hand side of the Printer.

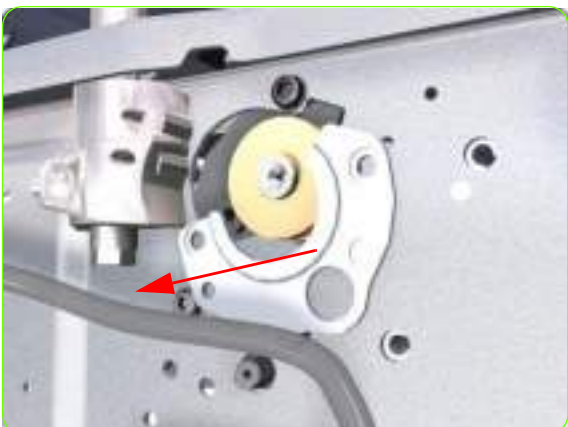

17. Remove the Cover.

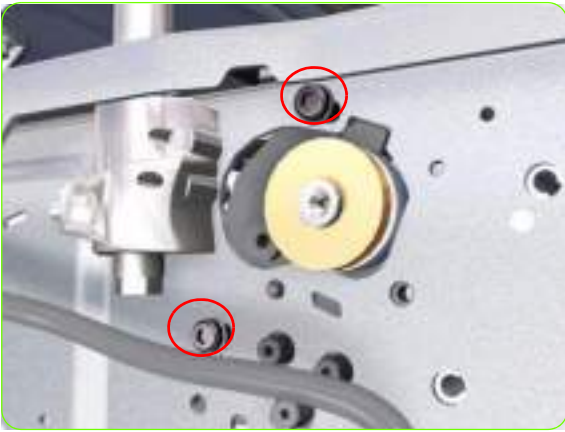

18. Remove T-20 screws that secure the Media-Axis Motor Bracket to the side-plate.



19. Remove two T-20 screws (**Type A**) that secure the Media-Axis Motor Bracket to the Chassis.



20. Remove the Media-Axis Motor Bracket from the Printer.

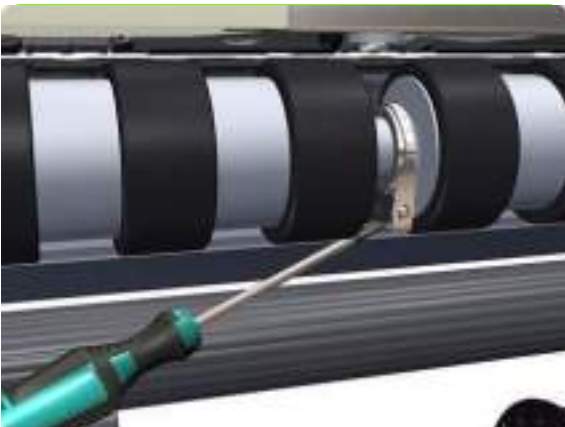

21. For the 60-inch model, use a flat bladed screwdriver to unclip the Roller Middle Support Cover.

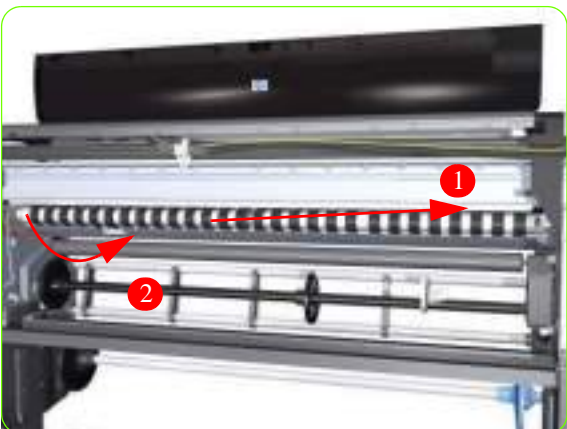
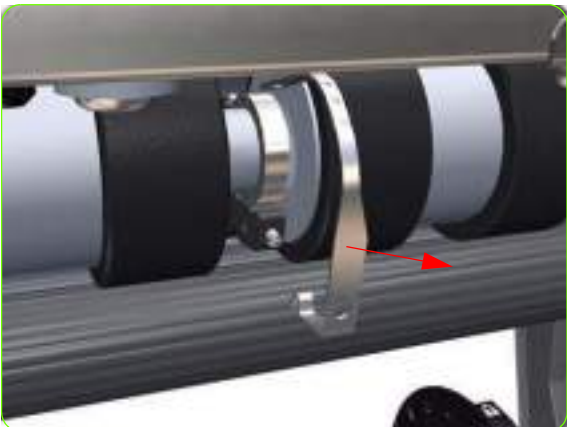
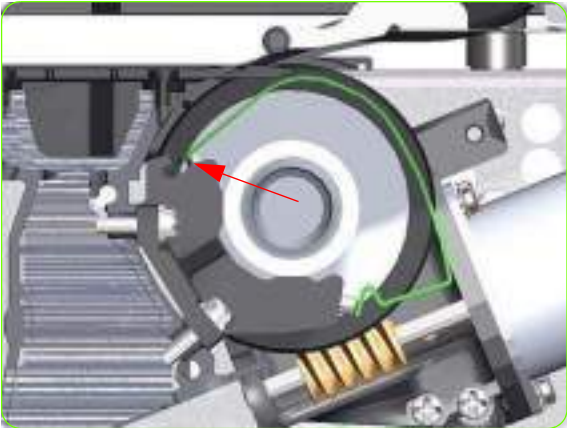

22. For the 60-inch model, rotate the Roller Middle Support Cover vertically.

23. For the 60-inch model, release the Roller Middle Support Cover from its attachment point.

24. For the 60-inch model, remove the Roller Middle Support Cover.

25. Remove the Drive Roller by sliding it to the right, then downwards and then out of the Printer.



NOTE: When reinstalling the parts, make sure you apply the grease (included with the support part) to the gears.

NOTE: After installing the NEW Drive Roller, make sure you perform the following Service Calibration.

- Paper Advance Calibration ⇒ Chapter 5.

Installation of the Drive Roller

When installing the Drive Roller, several different datums have to be met in order to ensure that the Drive Roller has no axial play. Use the following illustrations to ensure that ALL the datums are met:

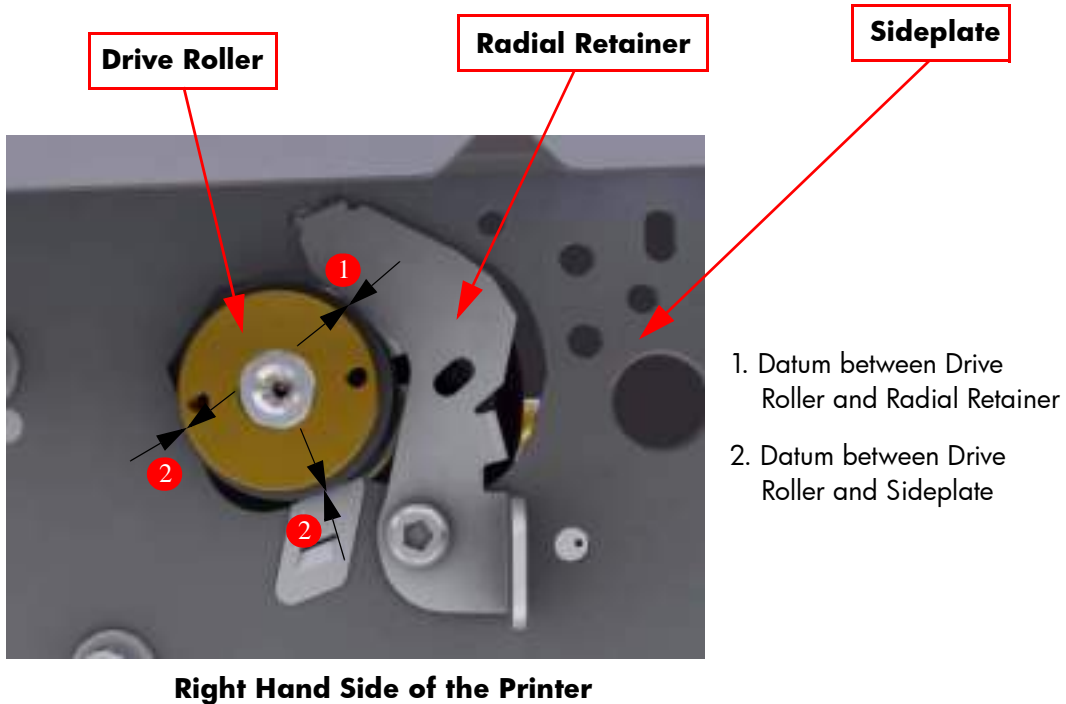
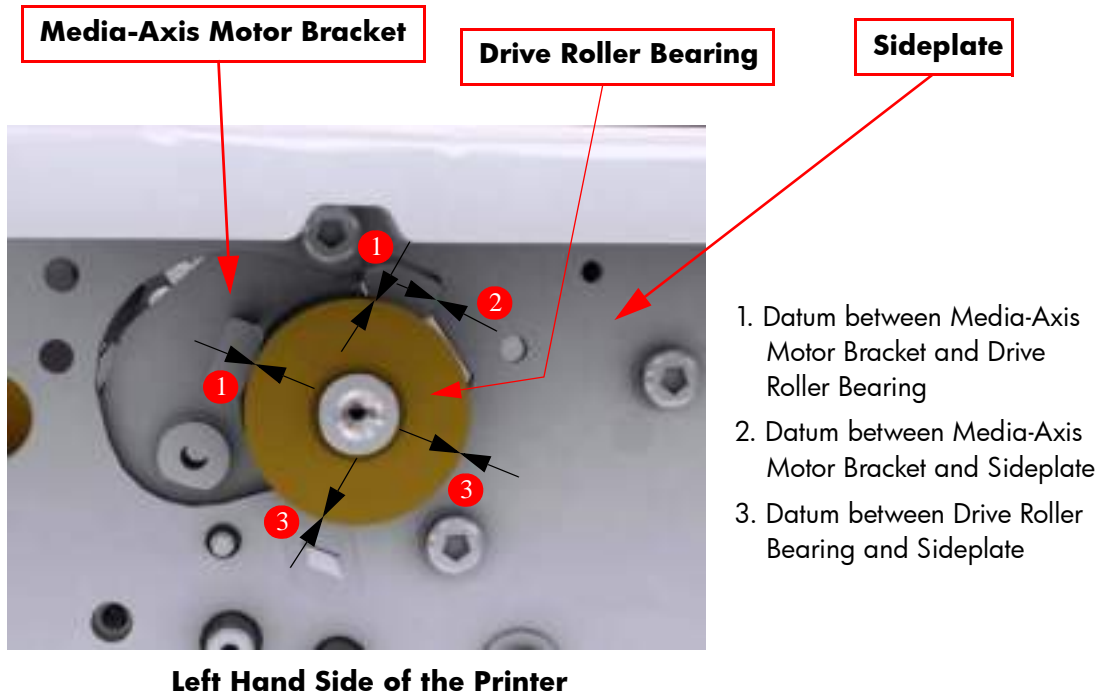

To make sure that ALL the datums are met when installing the Media-Axis Motor Bracket, make sure you follow these

instructions:



1. Place the Media-Axis Motor Bracket in the correct position on the Printer. Make sure you keep it pushed down (as shown in the illustration) until the first screw has been installed and fully tightened.
2. Install the first screw (T-15) in the position shown. Make sure you tighten the screw fully so that the Media-Axis Motor Bracket cannot be moved.
3. Check that there is no play (movement) between the Media-Axis Motor Bracket and the Drive Roller. If there is play, then check that the screw installed in the previous step is fully tightened.
4. Install the remaining two screws (T-15) that secure the Media-Axis Motor Bracket.

Right Rollfeed Module Assembly

Removal



WARNING! Switch off the printer and remove the power cable.

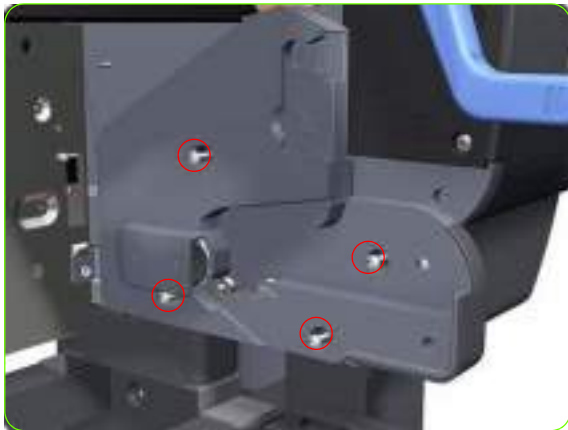

1. Remove the Input Roller ⇒ See page 550.
2. Remove the Media Spindle (if installed).
3. Remove four T-20 screws that secure the Right Rollfeed Module.
4. Remove the Right Rollfeed Module from the Printer.

Left Rollfeed Module Assembly

Removal



WARNING!: Switch off the printer and remove the power cable.

1. Remove the Left Cover ⇒ See page 325.
2. Remove the Ink Supply Station ⇒ See page 388.
3. Remove the Input Roller ⇒ See page 550.
4. Remove the APS Assembly ⇒ See page 395.
5. Remove the Media Spindle (if installed).
6. Remove one T-15 screw that secures the APS Mounting Plate to the Printer.

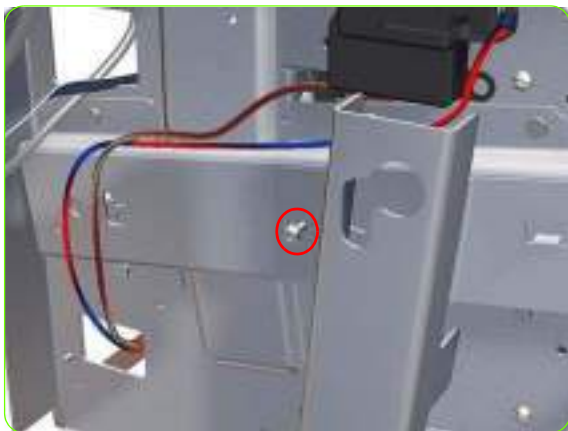

7. Tilt out the top of the APS Mounting Plate support.

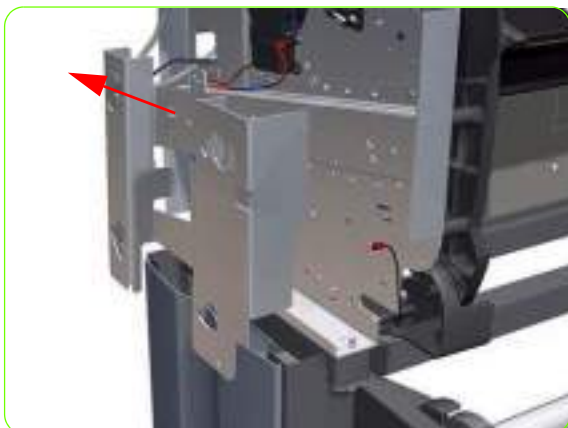

8. Remove the APS Mounting Plate support from the Printer.

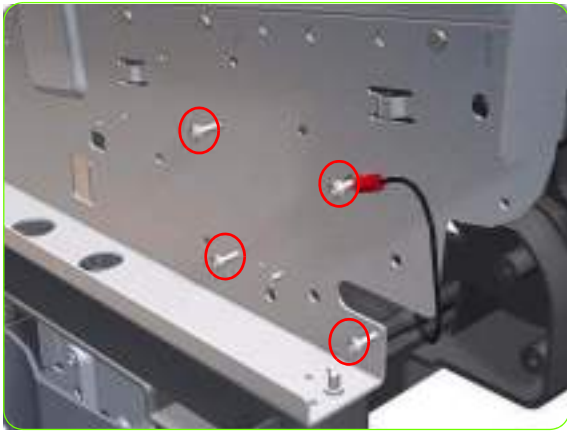

9. Remove four T-20 screws that secure the Left Rollfeed Module to the Printer.

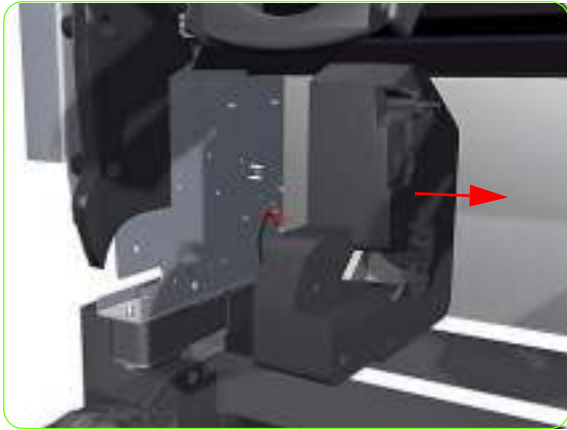

10. Remove the Left Rollfeed Module from the Printer.

Take-Up Reel Motor

Removal



WARNING!: Switch off the printer and remove the power cable.



1. Disconnect the Take-Up Reel Motor from the Parallel Port on the rear of the printer.



2. Remove the two rear T-20 screws that attach the Take-Up Reel Motor to the Right Leg Assembly.



3. Loosen the two front T-20 screws that attach the Take-Up Reel Motor to the Right Leg Assembly.



4. Disconnect the Take-Up Reel Sensors from the Take-Up Reel Motor.

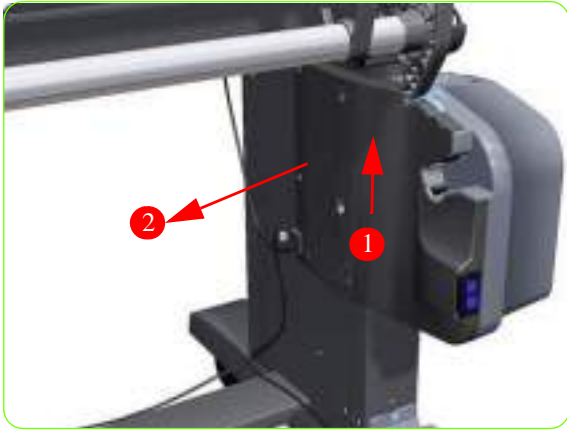

5. Lift the Take-Up Reel Motor sufficiently so you can remove it from the Right Leg Assembly.

Take-Up Reel Left Hand Module

Removal



WARNING!: Switch off the printer and remove the power cable.



1. Remove one rear T-20 screws that attaches the Take-Up Reel Left Hand Module to the Left Leg Assembly.



2. Loosen the two front T-20 screws that attach the Take-Up Reel Left Hand Module to the Left Leg Assembly.



3. Lift the Take-Up Reel Left Hand Module sufficiently so you can remove it from the Left Leg Assembly.

Take-Up Reel Deflector Supports

Removal



WARNING! Switch off the printer and remove the power cable.

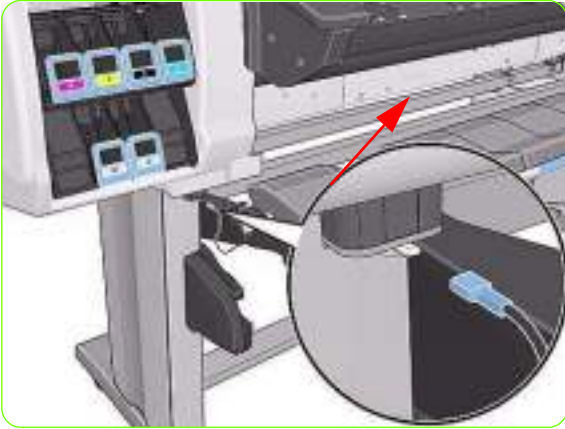

1. Disconnect the Take Reel cable.



2. Remove the Take-Up Reel Deflector from the printer.

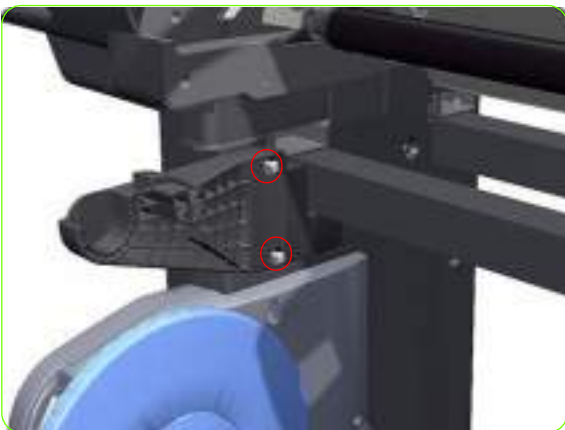

3. Remove the two T-20 screws that attach the Left Hand Deflector Support to the Left Leg Assembly.



4. Remove the Left Hand Deflector Support.



5. Remove the two T-20 screws that attach the Right Hand Deflector Support to the Right Leg Assembly.



6. Remove the Right Hand Deflector Support.

Take-Up Reel Sensors

Removal



WARNING! Switch off the printer and remove the power cable.

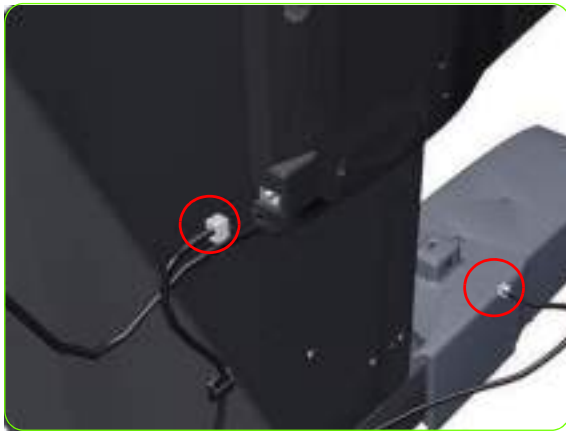

1. Disconnect the Take-Up Reel Sensors.



2. Remove the blue thumbscrew that attaches the Take-Up Reel Sensors to the Right Foot Assembly.



3. Slide the Take-Up Reel Sensors off the Right foot Assembly.

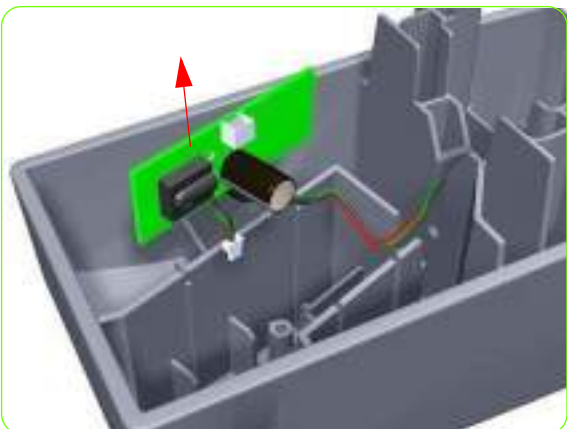
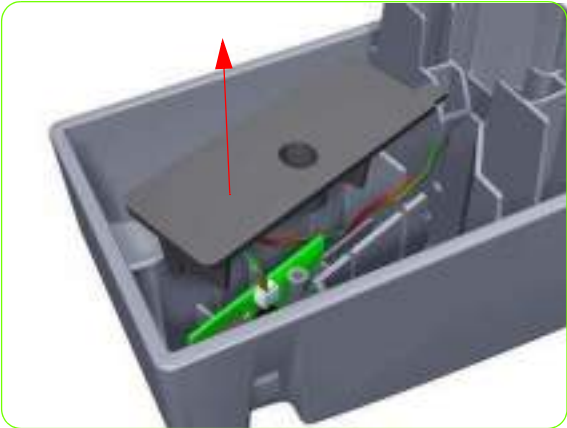
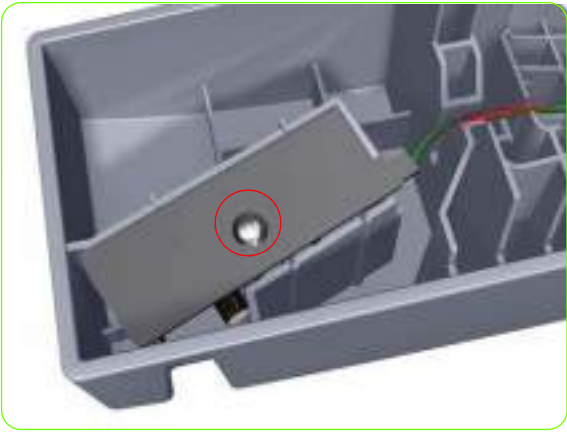

4. Remove one T-15 screw that attaches the cover of the receiver sensor to the housing.

5. Remove the cover of the receiver sensor to the housing.

6. Disconnect the connector from the receiver sensor.

7. Remove the receiver sensor from the housing.

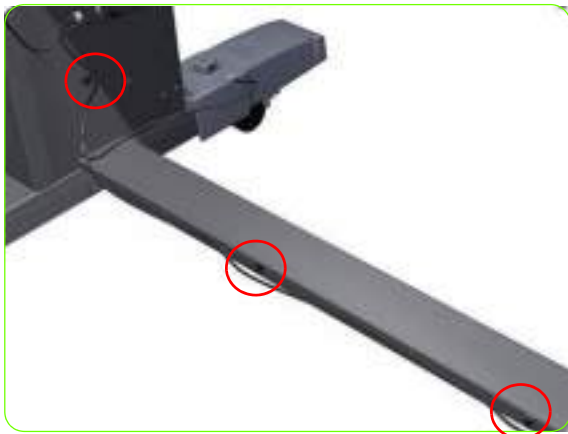

8. Unroute the Take-Up Reel Transmitter Sensor cable.

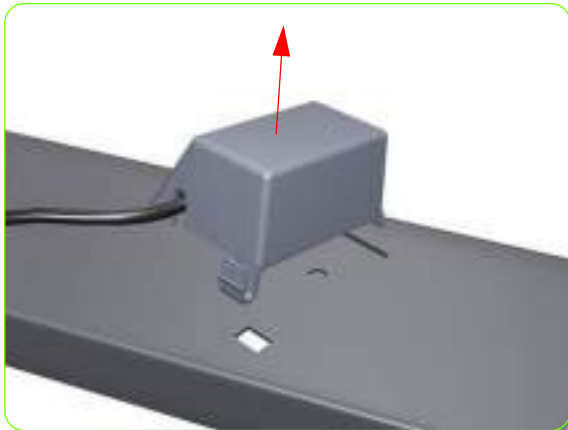

9. Unclip and remove the Take-Up Reel Transmitter Sensor from the X-Brace Assembly.

Electronic Cables routing

This section can be used as a reference section, to check the original routing of the cables

Rear Service Station Cables routing

Rear of the Service Station



Removal & Installation



Interconnect PCA Cables routing

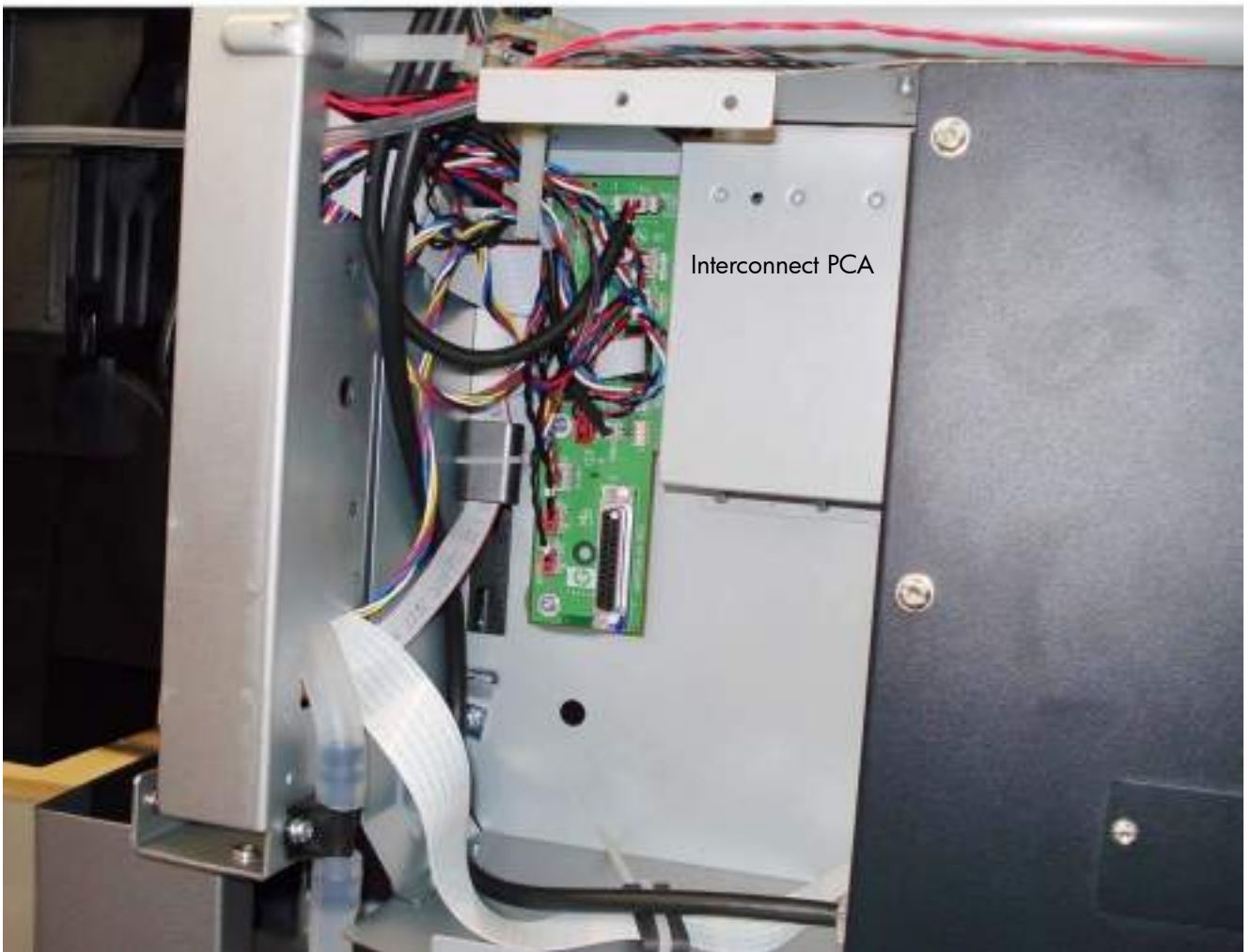

Removal & Installation

Electronics Module Cavity Cables routing

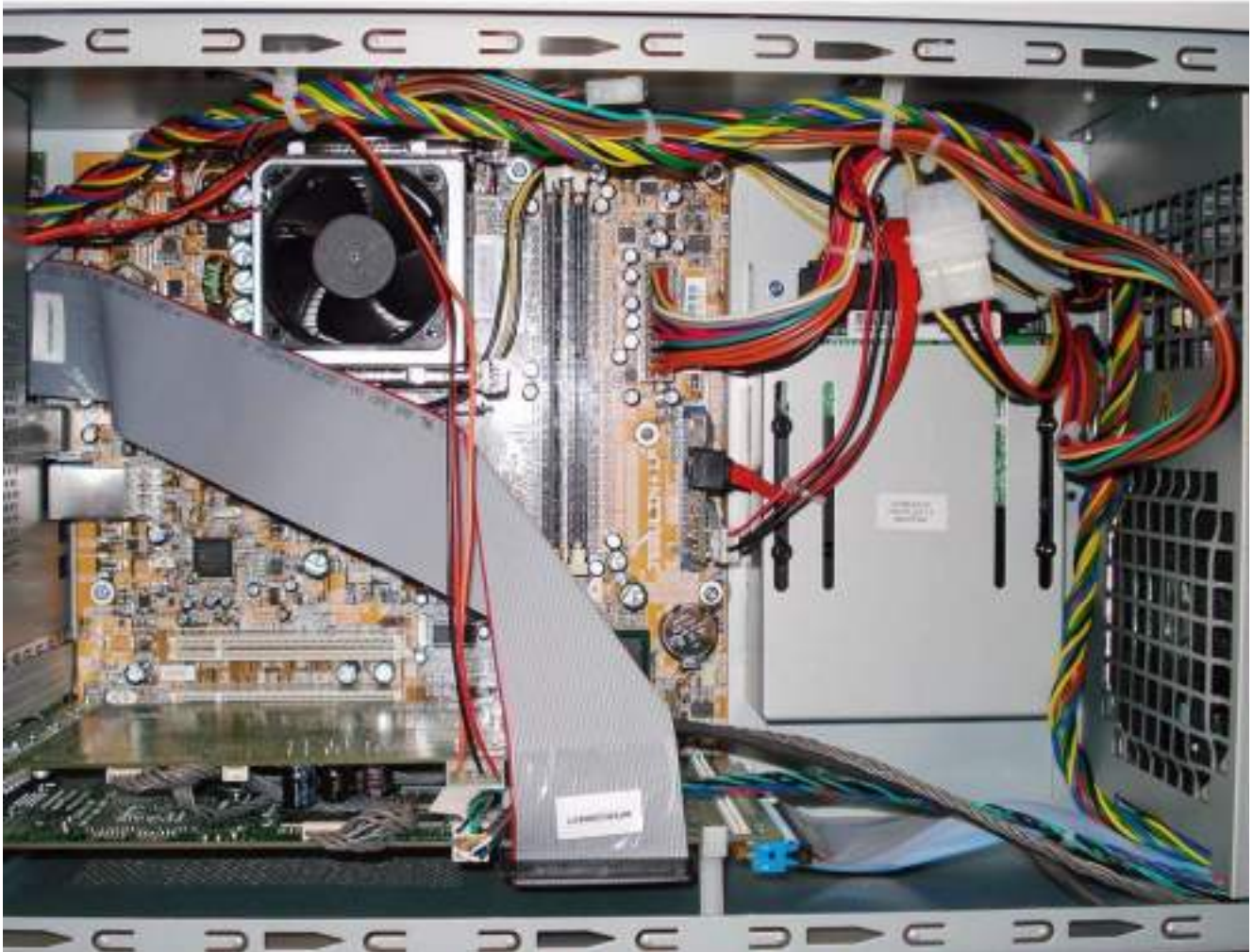

Removal & Installation

Main PCA Cables routing (behind Heaters Control Assembly)



Removal & Installation

Left Interconnect Cables routing

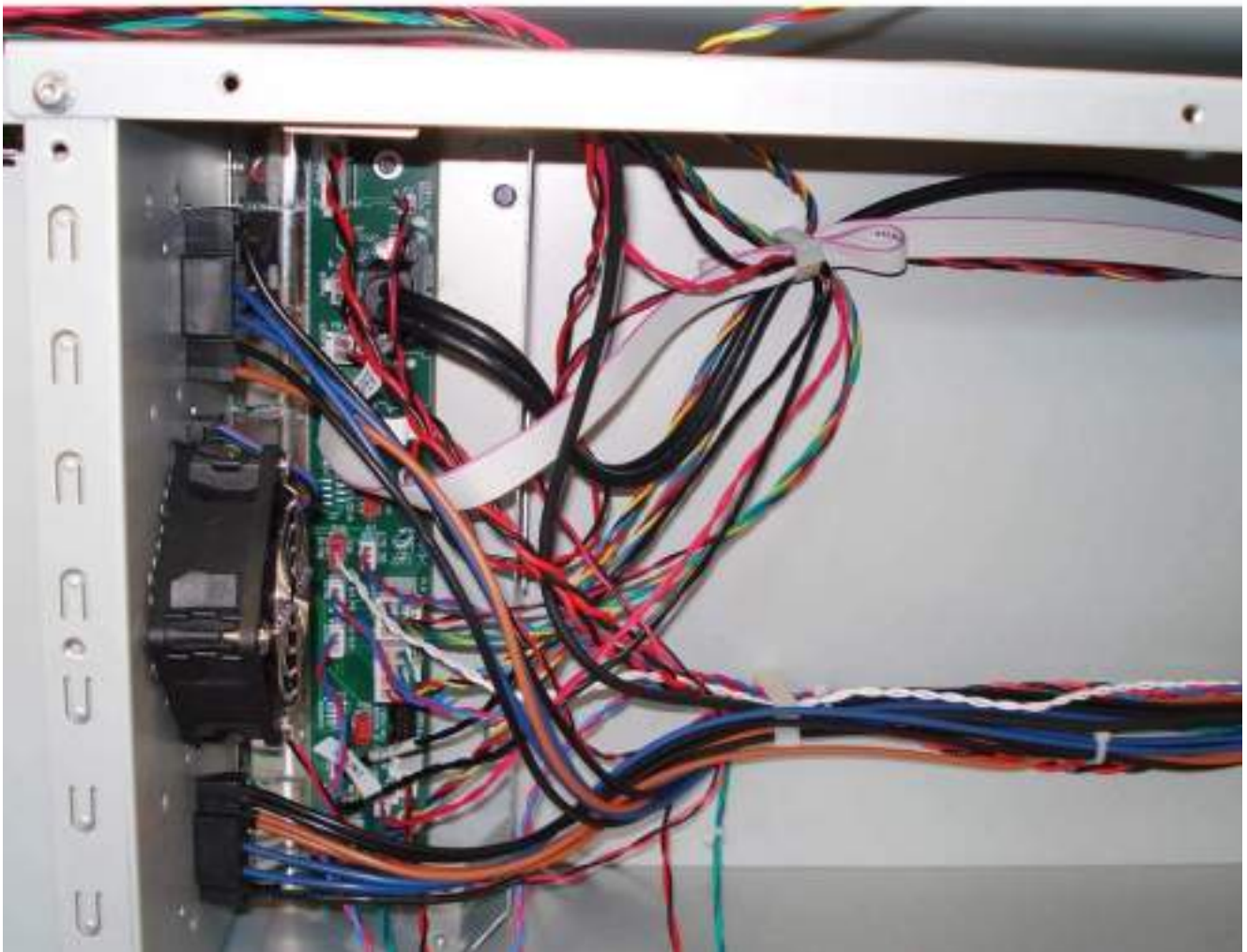

Removal & Installation

Left End Rear Chassis Cables routing

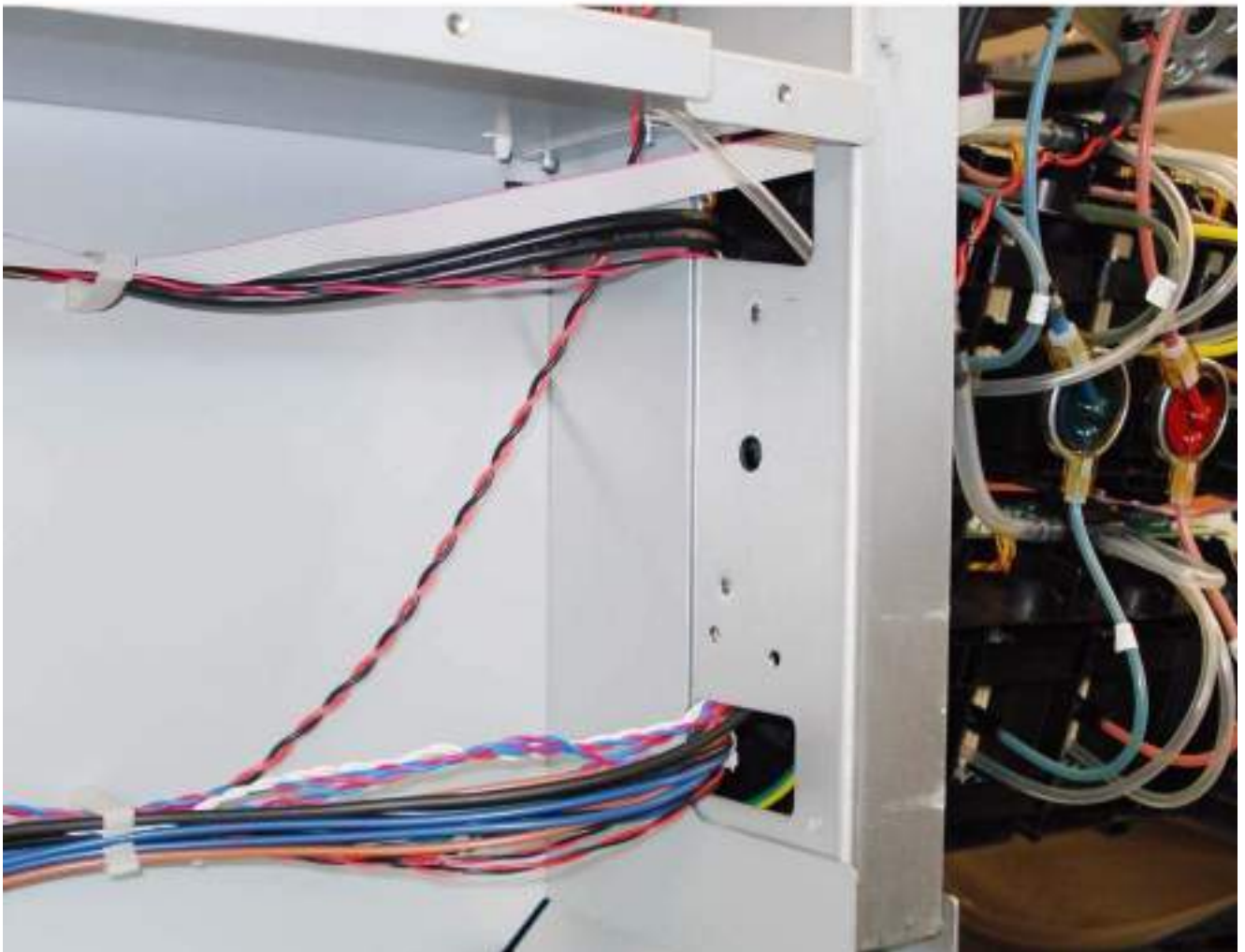

Removal & Installation

Circuit Breakers Cables routing

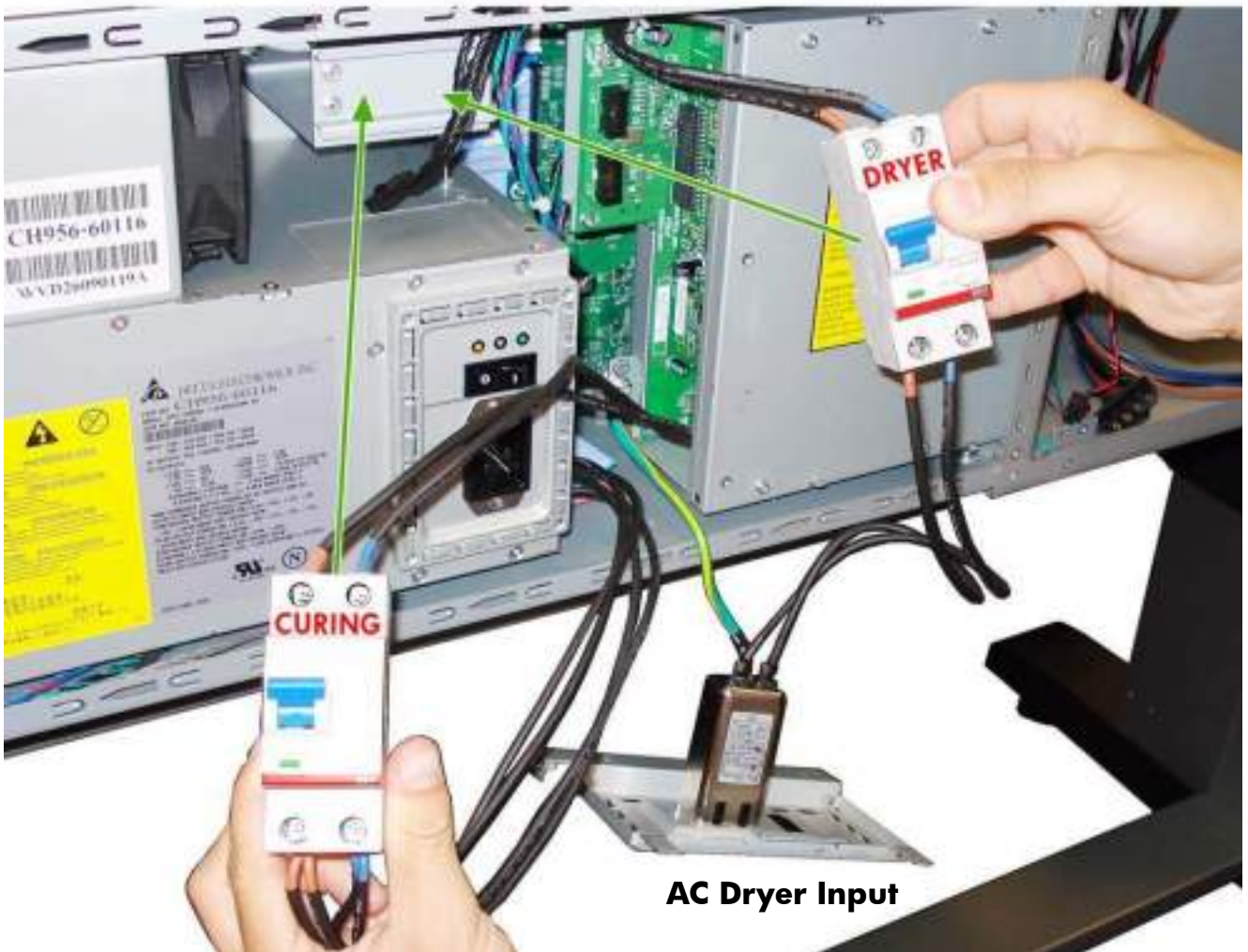

Removal & Installation

9 Preventive Maintenance

- Preventive Maintenance 600
 - Moisture on the Printer 600
 - Noisy Carriage Bushing 600
 - Belt Swelling 600
- Cleaning the Printer..... 600
 - General Cleaning..... 600
 - Cleaning the Drive Roller and Platen Rollers 600
 - Cleaning the Platen 601
- Applying Oil to the Platen rollers 603
- Lubricating the Carriage Assembly and rods 604
- Scheduled Maintenance..... 605
- Level of Printer Usage 605

Preventive Maintenance

Moisture on the Printer

Users should use the Printer in an environment between 20% and 80% relative humidity. To recover from moisture condensation, turn the Printer Off, and, using the main roller as a reference, wait until the Printer is completely dry before using it again.

Noisy Carriage Bushing

To prevent noisy movement of the carriage, remove aluminum or dust particles from the bushing at the back of the carriage, and from the slider path along which the bushing moves.

Belt Swelling

To prevent new belts from swelling incorrectly, keep them in their bags with desiccant until you need to install them.

Cleaning the Printer

To maintain the Printer in good operating condition, keep it free of dust accumulation, ink, and other contamination. Cleaning intervals are determined by the Printer environment and by the types of Printer supplies used.



CAUTION: The encoder strip used in this printer must never be cleaned, as cleaning it will cause irreparable damage, and will need to be replaced.

General Cleaning

Proper general cleaning should include the following:



WARNING!: To prevent an electric shock, make sure that the Printer is switched OFF and unplugged before any cleaning is performed. Do NOT let any water get inside the Printer.

1. Clean the outer surface of the Printer with a damp sponge or cloth. Use a mild soap and water solution if necessary. Do not use abrasive cleaners.
2. Wipe the Printer dry with a soft lint-free cloth.

Cleaning the Drive Roller and Platen Rollers



CAUTION: If ink is spilled on the Platen rollers, remove the ink immediately. Due to the ink's reflecting properties, ink on the Platen rollers can disrupt the ability of the sensor that detects the edge of the substrate. To remove ink from the Platen Rollers, perform the following procedure.

CAUTION: Prevent water or other liquids from running onto electrical components or circuits, or through openings in the Electronics Module.

1. Perform the Turn Drive Roller Utility (Refer to page 188).
2. Open the window and apply any common household cleaning solution (water based only) to a soft, lint-free rag and apply it to the Drive Roller and Overdrive surface while it is rotating. Make sure that you thoroughly clean the Drive Roller and Overdrive surface.
3. Press **Enter** when you have completed the cleaning procedure.
4. Allow the Drive Roller to dry before loading media in to the Printer.

Cleaning the Platen



NOTE: If a wide substrate is used to print after printing on a narrower substrate, you may find that the left hand side of the platen has become dirty. If this contaminated section of the platen is not cleaned, it might leave marks on the back of the substrate.

CAUTION: Be careful not to damage the substrate advance sensor (OMAS) when cleaning the platen. The sensor is covered by a very small rectangular window (less than 1 square centimeter) found close to the third pinchwheel from the right-

It is recommended to clean the Center Platen on a regular basis (at least every few months or when required) as follows:

1. Unload any substrate loaded from the Printer.
2. Turn off the printer and wait until it has cooled down, then unlock and open the window.



3. With a dry brush remove ink deposits from the Cutter Groove. A brush is available in the User Maintenance kit.

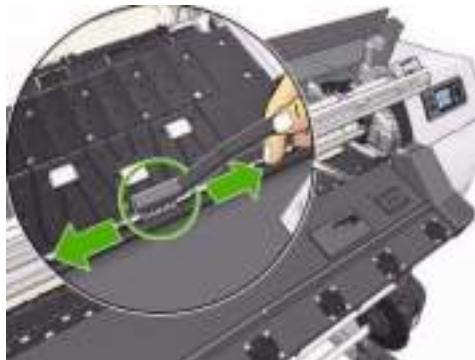

4. With the same brush, remove ink deposits from the platen surface.

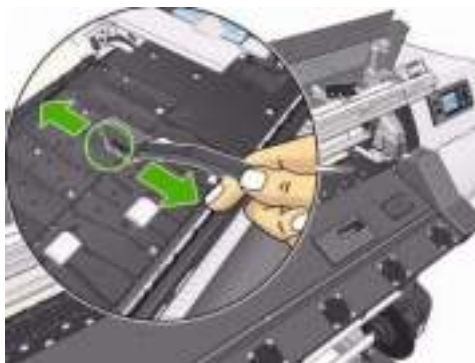

5. Use a clean, absorbent lint-free cloth, that has been slightly dampened with Methyl Acetate to wipe loosened ink deposits from the platen (Methyl Acetate is not supplied in the Maintenance Kit).

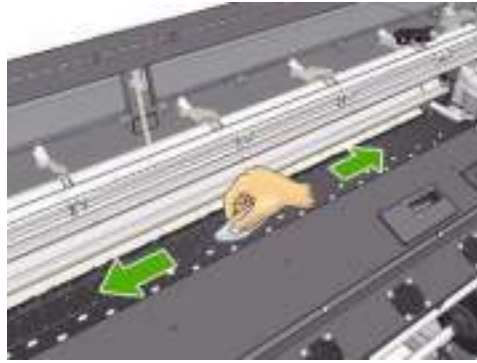

CAUTION: Do not use commercial cleaners or abrasive cleaners. Do not wet the Center Platen directly because you will leave too much moisture behind.

6. Clean the Cutter ramp with the damp cloth.

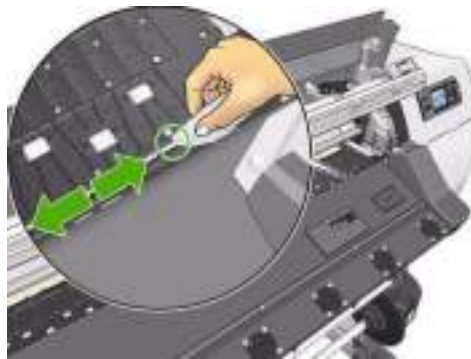

7. Clean the exposed part of the wheels with a dry cloth. Ideally, clean the whole circumference of these wheels (you can use Turn Drive Roller Utility on page 188).

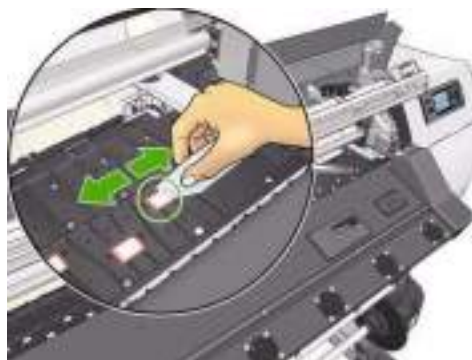

8. Methyl Acetate is a flammable liquid, after the cleaning procedure has finished, remove the liquid and the cloth away from the vicinity of the printer.
9. Wait three or four minutes to let the liquid evaporate, before turning on the printer

Clean the OMAS window

The OMAS (referred to as the Paper Advance Sensor in the customer documentation) is covered by a very small rectangular window (less than 1 square centimeter in size and shown) close to the third platen roller from the right, it is this window that requires cleaning. The ability of the OMAS sensor to detect the substrate as it passes is a critical part of the functioning of the printer. The OMAS window must be cleaned

completely of any dried ink, until the swabs used to clean it, do not show any indication of ink present on the window.

1. Unload the substrate.
2. Turn of the printer and wait for it to cool down.
3. Wipe the sensor with one of the cotton swabs provided in the User Maintenance Guide kit, slightly dampen with Methyl acetate to remove dried ink from the sensor window.

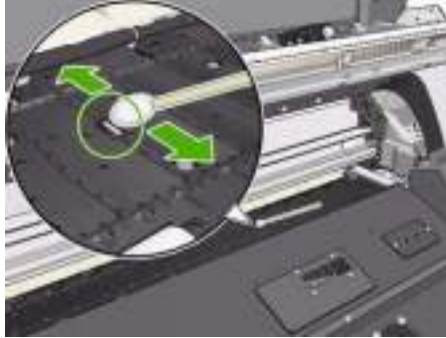

4. If the sensor window is heavily coated with dried ink, you may need to apply some pressure while wiping, helping the cotton to absorb the ink. Continue cleaning with fresh swabs until the cotton stays clean and the sensor window looks clean. When reflecting ambient light, a clean sensor shows a blue-colored reflection that should extend uniformly across its whole surface. You can see this reflection by moving closer and slightly changing your angle of view.
5. Methyl Acetate is a flammable liquid, after the cleaning procedure has finished, remove the liquid and the cloth away from the vicinity of the printer.
6. Wait three or four minutes to let the liquid evaporate, before turning on the printer

Applying Oil to the Platen rollers

Occasionally, it maybe necessary to oil the Overdrive in order to stop the rollers from squeaking:

1. Unlock and open the Window.
2. Locate the small holes in the platen near some of the rollers.

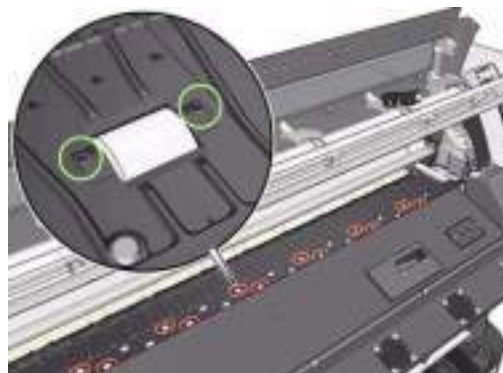

- Put three drops of oil into each hole in the platen.



CAUTION: Be careful not to spill oil onto the platen



- If oil spills onto the platen, wipe the platen by using the cloth that was supplied within the User Maintenance guide kit. But do not wipe the rollers.



- Close and lock the printer window.

Lubricating the Carriage Assembly and rods

The Printhead Carriage Assembly occasionally (about twice a year) needs to be lubricated so that it can slide easily along the Slider Rod, the Front Panel will advise the customer when this is required.

- Using the Front Panel, in the Maintenance menu, select "Carriage Roller Lubrication". The Carriage Assembly will move to the center of the Printer.



CAUTION: If the carriage Assembly remains stationary in the middle of the Printer for more than 7 minutes, the Carriage will automatically return to the Service Station on the right.

2. Unlock and open the printer window and apply a few drops of oil (bottle of oil can be found in the Maintenance Kit) to the pads on either side of the Carriage Assembly.



3. Apply a few drops of oil directly to the Slider Rod on either side of the Carriage Assembly.



4. Press Ok when the lubrication procedure has finished.
5. Clean the substrate jam reflector using a lint-free cloth dampened with distilled water. If you find dried ink that you cannot remove, try using a lint-free cloth dampened with Methyl Acetate.



6. Press Ok when the jam reflector has been cleaned.
7. Close and lock the Printer Window

Scheduled Maintenance

In some segments of the printer market, the customer tends to print more than the maximum number of prints that the throughput allows, exceeding by far the limit of the design. When this happens the customer runs into print quality problems and continuous Printer failures.

The purpose of scheduled preventive maintenance is to avoid these failures - ensuring a good performance during all the product life.

Level of Printer Usage

Normal printer use means 6,000,000 Carriage Cycles (which corresponds to approximately 100,000 A0 prints on average). Under normal usage conditions, it will be approximately 5 years before the printer needs maintenance. If the printer is used more than the normal usage conditions, then it will need maintenance service much more frequently.

One of the EEROM counters is assigned to counting the number of carriage cycles. When certain components of the Printer exceed this amount, the front panel displays the following message:

“Service Maintenance #1 required”

The following message is triggered depending on the number of Service Station cycles.

“Service Maintenance #2 required”

The following message is triggered depending on the total quantity of ink that has gone into the Ink Funnel.

“Service Maintenance #3 required”

Once one of the maintenance advised messages is displayed, the appropriate service maintenance kit must be used to replace the most worn parts of the printer. Use the Removal and Installation Chapter of this Service Manual as a guide to replace the necessary parts.

The following PM Kit covers both Maintenance advised messages:

Service Maintenance Kit 1

This Service Maintenance Kit #1 includes the following parts:

- Encoder Strip and sensor
- Ink Supply Tubes and Trailing Cable
- Carriage Assembly (without the PCA, SOL, Line sensor and metal parts)
- Carriage PCA Cover
- Line sensor
- Scan Axis Motor Assembly
- Belt and Tension kit
- Paper Jam sensor.

Service Maintenance Kit 2

This Service Maintenance Kit #2 includes the following parts:

- Service Station: including the Service station Motor, Drop detector, Aerosol System and Web Wipe Advance Assembly.
- Complete Spittoon system including the tubes, check valve, Ink funnel.
- Line sensor
- Paper Jam sensor

Clean the IR sensors with a lint free cloth and isopropyl alcohol.

Service Maintenance Kit 3

This Service Maintenance Kit #3 contains the following components:

- aerosol Fan and filters
- check valve
- Line sensor
- Platen Label

Clean the IR sensors with a lint free cloth and isopropyl alcohol.

10 Repacking instructions

- Re-packaging instructions 608
- Removing the Consumables 609
- Re-installing the retention parts 612
- Securing with adhesive tape 614
- Covering the Printer 618

Re-packaging instructions

Reuse the packaging material

Do not discard of the packaging that the printer came with as they must be reused every time the printer needs to be shipped.

There are generic packaging components such adhesive tape, plastic strips, etc. that cannot be reused in all the cases. Ensure you have some spare tape to complete the packaging process (industrial tape can be used in most of the cases)

There are critical packaging components, designed to lock-down specific printer components during transportation. These components must be stored until re-packaging is needed.

Removing the Consumables



WARNING! Switch off the printer and remove the power cable.

1. Remove the Substrate ⇒Users guide.
2. Remove the Printheads ⇒Users guide
3. Remove the Ink Cartridges ⇒Users guide
4. Remove the Printhead Cleaning Cartridge ⇒Users guide.
5. Remove the Ink Funnel ⇒Users guide
6. Remove the Printhead Cleaning Container ⇒Users guide
7. Install the orange caps onto the Printheads, and place them in the original packaging. Seal with adhesive tape.
8. Place the Printheads in the original packaging, and seal with adhesive tape.





9. Wrap the Printheads in packaging of some description, bubble-wrap, paper etc.



10. Place the plastic cover on the top of the Printhead Cleaning Cartridge.



11. Place the Printhead Cleaning Cartridge into the original bag, and seal with adhesive tape.



12. Clean the rear of the Ink Cartridge from any excess ink.



13. Place the Ink Cartridges in the original box.



14. Place the Printheads, Printhead Cleaning Cartridge and the Ink funnel in the same box as the ink Cartridges.

Re-installing the retention parts

Secure the parts inside the carriage path for transportation.

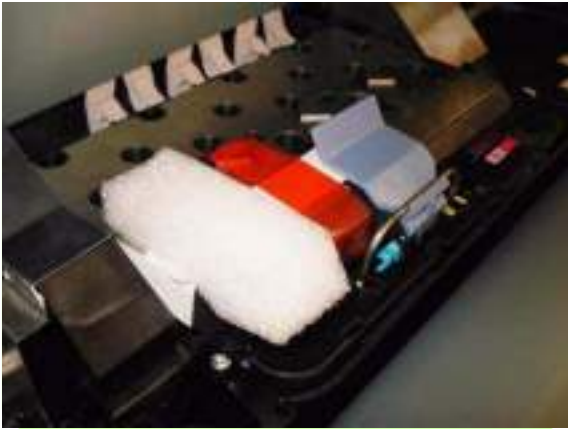

15. Add packing foam to the right side of the Carriage, and secure with the red adhesive tape.
16. Push the Carriage to the transport position to the right side of the Printer.



17. Add packing foam to the left side of the Carriage, and secure with the red adhesive tape.



18. Install the top part of the Ink Tubes Carton Pad.



19. Install the bottom part of the Ink Tubes Carton Pad to secure the Ink Tubes in place during transportation.



20. Remove the hubs from the media spindle, and reinstall the media spindle.

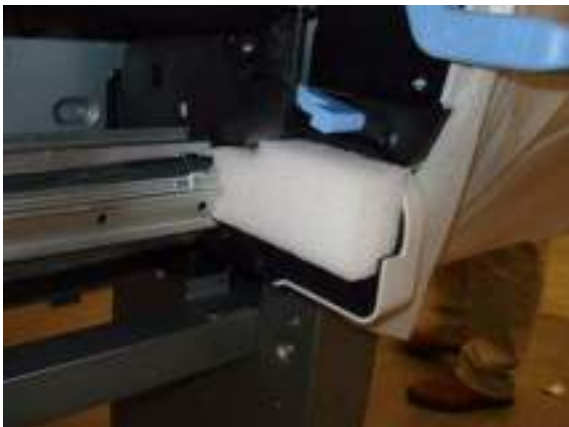

21. Install the Spindle retention foam.

Securing with adhesive tape



22. Place adhesive tape on the corners of the left window to protect the cover from vibration damage, from the Top Cover.



23. Place adhesive tape on the corners of the right window to protect the cover from vibration damage, from the Top Cover.



24. Place adhesive tape on the rear of the Right Connector cover.



25. Place adhesive tape on the Printhead Cleaning Cartridge Cover.



26. Place adhesive tape on the right corner of the window.



27. Place adhesive tape on the left corner of the window.



28. Place two lines of adhesive tape along the top of the Printer.



29. Place two lines of adhesive tape on both sides of the front Panel.



30. Tape silicate bags onto the rear of the printer.



31. Remove two T-15 screws securing the Printhead Cleaning Container Bracket.



32. Remove the Printhead Cleaning Container Bracket from the rear of the Printer.



33. Place the Printhead Cleaning Container in a cardboard box (with the Ink Cartridges).



34. Wrap the Drain Tube in a plastic bag, and secure with tape.



35. Secure the Drain Tube to the underside of the Printer.

Covering the Printer



36. Place dust cover over the Left Cover.



37. Place dust cover over the Right Cover.



38. Place dust cover over the top of the Printer.



39. Install the Left and Right End Cap.



40. Remove screws from underneath the printer, that secure the printer to the legs.



41. Use a crane to lift the Printer from the legs assembly.



42. While lifting the Printer, use cardboard to protect the area that comes into contact with the straps of the crane

43. Secure the rest of the bag underneath the Printer.



44. Place the two foam blocks on the pallet.



45. Place the Printer onto the pallet, onto the two foam blocks.



46. Secure the four corners of the pallet.



47. Place the left foam packing part, and secure with adhesive tape.



48. Place the right foam packing part, and secure with adhesive tape.

49. Disassemble the Take Up Reel and the Legs.



50. Place the tubes of the Take Up Reel in the cardboard box, and secure the box with adhesive tape.



51. Place the rest if the TUR parts into the cardboard box, and secure the box with adhesive tape.



52. Insert the anti-slip material over the end of the two feet.



53. Place the Legs assembly in the plastic bags and place in the original box.



54. Place all the boxes on top of the printer.



55. Use strapping to secure the boxes.



56. Cover the printer with the large cardboard cover.



57. Install the large cover over the top of the printer.



58. Use strapping to secure the boxes.

Special checks before turning-ON the printer

To ensure that there are not functionality problems when starting the printer, check the following before switching on.

- Once the packaging elements have been removed, open the window and check that the tubes are correctly installed. The tubes must be in the plastic rail (or tube shelf) so the carriage moves freely along the print zone without clashing with the tubes.
- Remember to replace the Printhead Cleaning Container and install the Drain Tube into the container.

11 Safety Precautions

- General Safety Guidelines 626
- Electrical shock hazard 626
- Heat Hazard 626
- Fire Hazard 626
- Mechanical Hazard..... 626
- Scan Axis Encoder Strip hazard 627
- Burn hazard (heating and curing) 627
- Lifting and handling 627
- Warning Labels 628

General Safety Guidelines

Before servicing the printer, read the following safety precautions to make sure that you work on the printer safely.

- Refer to installation instructions removing and replacing parts.
- Whenever serving the printer, turn off the printer, disconnect **both** power cords from the power sockets.

Electrical shock hazard



WARNING!: The drying and curing modules operate at hazardous voltages capable of causing death or serious personal injury.

The printer uses two power cords. Disconnect both power cords before servicing the printer.

- To avoid the risk of electric shock do not attempt to dismantle any of the components of the printer with the two power cords connected to the printer.

Heat Hazard

The drying and curing subsystems of the printer operate at high temperatures and can cause burns if touched. To avoid personal injury, take the following precautions.

- Do not touch the internal enclosures of the printer's drying and curing modules when they are hot. Even after opening the window lock which disconnects drying and curing power, the internal surfaces could be hot.
- Take special care when accessing the substrate path.

Fire Hazard

The Dryer Assembly and Curing Module operate at high temperatures.

To avoid the risk of fire, take the following precautions.

- Check that the power supply voltage specified on the nameplate is the one being used by the customer.
- Make sure the power cords use are from dedicated power lines, each protected by a branch circuit breaker according to the rating of the wall socket. Do not use a power strip (relocatable power tap) to connect both power cords.
- Check that the power cords are supplied by HP with the printer. Do not use a damaged power cord. Do not use the power cords with other products.
- Do not use aerosol products that contain flammable gases inside or around the printer.
- Do not block or cover the openings of the printer.
- Load substrates that can be used at an operating temperature of up to 125°C (257°F), and have auto-ignition temperatures above 250°C (482°F).

Mechanical Hazard

When the carriage moves, it can crush or cut body parts if they are in the way.

Best practice

- Keep your clothing or body parts safe from moving parts of the printer.
- Avoid wearing loose clothing, jewelry like necklaces or bracelets, or any kind of hanging objects.

- If you have long hair, make sure that it is restrained.
- Take care that sleeves and gloves do not get caught in the mechanical parts of the printer.
- Stay clear of the print path when the carriage is moving.
- Also make sure that there are no tools obstructing the operation of the printer.

Scan Axis Encoder Strip hazard

The Scan Axis Encoder Strip is very sharp, and can easily cut your hands when you must work near it.

Best practice

- Wear protective gloves if you must touch the Scan Axis Encoder Strip.
- Do not wear loose clothing or jewelry.

Burn hazard (heating and curing)

The components of the heating and curing systems get very hot and can seriously burn you.

Best practice

- Be careful when you work near the print path.
- Before working on the heating and curing modules, make sure that they are completely cooled off.









Lifting and handling

Improper handling of heavy materials can lead to serious bodily injury.

Best practice

- When handling substrate rolls, care must be taken to avoid back strain and/or injury.
- Always use a forklift, pallet truck, or other handling equipment to lift substrates.
- Always wear personal protective equipment like boots and gloves.
- Follow any manpower instructions included in this service manual when you replace components. Many components, require at least two people for removal.

Warning Labels

Label	Description
	<p>Risk of burns. Do not touch the internal enclosures of the drying and curing modules.</p>
	<p>Risk of burns. Do not touch the drying enclosure of the printer. Even after opening the window latch, which disconnects the power to the drying and curing modules, the internal surfaces could be hot.</p>
	<p>Electric shock hazard. The printer has two input power cords. A voltage is still present in the drying and curing modules after the main switch is turned off. Disconnect all power cords before servicing.</p>
	<p>See installation instructions before connecting to the supply. Ensure that the input voltage is within the printer's rated voltage range. The printer requires two dedicated lines, each protected by a branch circuit breaker according to the rating of the wall socket outlet. Use only earthed mains outlets and the power cords supplied by HP with the printer.</p>
	<p>Risk of trapped fingers. Do not touch spindle gears while moving.</p>
	<p>Risk of trapped hands. Do not push the roll while loading. Lift the loading table to ease the spindle into the printer.</p>
	<p>Do not put objects on top of the printer. Do not cover the fans.</p>
	<p>You are recommended to wear gloves when handling ink cartridges, printhead cleaning cartridges and the printhead cleaning container.</p>

