



**service  
manual**

**hp designjet  
4000 series printers**



## For HP Internal Use Only

©Copyright Hewlett-Packard Company 2004

This document contains proprietary information that is protected by copyright. All rights are reserved. No part of this document may be photocopied, reproduced, or translated to another language without the prior written consent of Hewlett-Packard Company.

First Edition, December 2004

Second Edition, April 2005

## Warranty

The information contained in this document is subject to change without notice.

**Hewlett-Packard makes no warranty of any kind with regard to this material, including, but not limited to, the implied warranties of merchantability and fitness for a particular purpose.**

Hewlett-Packard shall not be liable for errors contained herein or for incidental or consequential damages in connection with the furnishing, performance, or use of this material.

## WARNING

The procedures described in this manual are to be performed by HP-qualified service personnel only.

### Electrical Shock Hazard

Serious shock hazard leading to death or injury may result if you do not take the following precautions:

- Ensure that the ac power outlet (mains) has a protective earth (ground) terminal.
- Disconnect the Printer from the power source prior to performing any maintenance.
- Prevent water or any other liquids from running onto electrical components or circuits, or through openings in the enclosure.

### Electrostatic Discharge

Refer to the beginning of Chapter 4 of this manual, for precautions you should take to prevent damage to the Printer circuits from electrostatic discharge.

### Safety Symbols

General definitions of safety symbols are given immediately after the table of contents.

## WARNING

The Warning symbol calls attention to a procedure, practice, or the like, which, if not correctly performed or adhered to, could result in personal injury. Do not proceed beyond a Warning symbol until the indicated conditions are fully understood and met.

### CAUTION

The Caution symbol calls attention to an operating procedure, practice, or the like, which, if not correctly performed or adhered to, could result in damage to or destruction of part or all of the product. Do not proceed beyond a Caution symbol until the indicated conditions are fully understood and met.

Content Management Department,  
Barcelona Division,  
Hewlett-Packard Espanola, S.A.  
Avda. Graells, 501  
08190 Sant Cugat del Valles  
Spain



# service manual

hp designjet  
4000 series printers

## Using this Manual

### Purpose

This Service Manual contains information necessary to test, calibrate and service:

- **hp** designjet 4000 printer (Model Q1273A)
- **hp** designjet 4000ps printer (Model Q1274A)

For information about using these printers, refer to the corresponding User and Quick Reference Guides.

### Readership

The procedures described in this Service Manual are to be performed by HP Certified service personnel only.

### Part Numbers

Part Numbers for Printer options, accessories and service parts are located in Chapter 7.

### Conventions

A small arrow  $\Rightarrow$  is used to indicate other parts of the Service Manual where you can find information related to the topic you are consulting.

# Table of Contents

**Troubleshooting 1-1**

**System Error Codes 2-1**

**Ink Supplies Troubleshooting 3-1**

**Service Tests and Utilities 4-1**

**Service Calibrations 5-1**

**Print Quality 6-1**

**Parts and Diagrams 7-1**

**Removal and Installation 8-1**

**Preventive Maintenance 9-1**



[Empty table of contents area]

# Troubleshooting

# 7

Introduction	1-2
Troubleshooting System Error Codes	1-2
Performing a Service Test on a Failed Assembly	1-2
Performing the Necessary Service Calibrations	1-3
Solving Print Quality Problems	1-3
The Printer does not Power ON	1-3
The Printer Continuously Rejects Printheads	1-3
Cover Sensors are not Working	1-3
The Line Sensor has Problems Detecting Media	1-4
Troubleshooting Shutdowns	1-5
Vacuum suction much lower at high altitudes	1-6
Banding at variable extreme environmental conditions	1-6
Printhead Crashes/Smears on High Density Prints Using Coated Media	1-6
Banding due to Ink Cartridge replacement while printing	1-7
34" Rice Paper not supported	1-7
Cut Sheet rice paper loading failure	1-7
Worm marks on HP Coated media with light area fills	1-7
Solving Media-Handling Problems	1-8
Using the Buzzer at Power-up to Troubleshoot	1-9
Using the Power-up Sequence to Troubleshoot	1-10
Using the Power Switch LEDs to Troubleshoot	1-13
Using the PCA LEDs to Troubleshoot	1-14
How to Interpret the Service Information Pages	1-17

## Guide to Troubleshooting the Printer

### Introduction

This chapter will guide you through the relevant steps to take when troubleshooting the printer.

### Troubleshooting System Error Codes

Chapter 2 - *System Error Codes* contains a list of system error codes and their respective descriptions and recommended corrective actions. Only try one recommended action at a time and check if the error code has disappeared.

If you have an error code which is not documented in this Service Manual or you have an error which you cannot resolve, then report the error to the HP Response Center or the nearest HP Support Office. When reporting the error, have the following information ready:

- Model and Serial Number of the printer.
- Which firmware revision the printer is using (See Note below). Check firmware in *Utilities / Statistics / Code rev.*
- The complete error number (See Note below).
- The Service Configuration Print.
- The Current configuration sheet.
- Which software application the customer is using (name, version, etc.).

**When reporting the System Error Code, make sure that you supply the full Error Code and the firmware version. Without this information, HP Support Personnel cannot help you.**

### Performing a Service Test on a Failed Assembly

If possible, always perform a Service Test on the component/assembly that you are about to replace, just to make sure that is the component/assembly that has failed.

**If the test on that component/assembly passes, you should NOT replace it.**

For information on the Service Tests and how to use them see Chapter 4 - *Service Tests and Utilities*.



## Performing the Necessary Service Calibrations

Is the printer calibrated correctly after replacing a component? For information on the Service Calibrations and how to use them see Chapter 5 - *Service Calibrations*.

**Remember that certain Calibrations are required even if an Assembly has been disassembled to gain access to another Assembly or Component.**

## Solving Print Quality Problems

Whenever a Print Quality problem appears, it is advisable to print the Diagnostic Print to help diagnose the problem. The Diagnostic Print will help you differentiate between possible printhead errors and other problems such as incorrect front-panel selection, driver or RIP configuration or mechanical problems. For information on solving Print Quality problems see Chapter 6 - *Print Quality*.

## The Printer does not Power ON

- 1 Check that the power cord is connected correctly to the Printer and to the Power Socket.
- 2 Check that the Power Switch on the BACK of the Printer is in the ON position.
- 3 Check to see if any of the LEDs on the Power Switch are On. If any of the LEDs are On, then refer to Page 1-13 for more information.
- 4 Check that the Front-Panel Cable is correctly connected to the Electronics Module. Also make sure that the Front-Panel cable is not damaged.
- 5 Replace the Power Supply Unit ⇒ Page 8-78.

## The Printer Continuously Rejects Printheads

- 1 Clean the flex contacts on the Printhead and in the Carriage Assembly using the Carriage Interconnect Wiper (Refer to Chapter 3) and try again.
- 2 If ALL the Printheads are rejected (the status message on the Front Panel does NOT show "OK" for ALL the Printheads) then perform the Electronic Systems Test ⇒ Page 4-17.

## Cover Sensors are not Working

- 1 Perform the Sensors Test ⇒ Page 4-28.
- 2 Check if the cable for the faulty sensor is not damaged and is connected correctly.
- 3 Replace the faulty Sensor.

## The Line Sensor has Problems Detecting Media

- 1 Check the type of media that is being used since the Line sensor may have problems detecting transparent media or some types of Non-HP media. Try loading white HP media in to the Printer and check if the Line sensor detects it.
- 2 Excessive ink deposits on the Platen surface can fool the sensor by reflecting the light. Clean the Center Platen.
- 3 The Line Sensor is not calibrated correctly. Perform the Line Sensor Calibration ⇒ Page 5-16.
- 4 The Line Sensor is damaged or faulty. Replace the Line Sensor ⇒ Page 8-89.

## Troubleshooting Media Jams/Printhead Crashes

**If using HP Coated Media when problem occurred, please also refer to Page 1-6.**

The failure modes "media jam" and "head crash" are grouped together because in many cases a media jam causes the media to lift up into the Carriage path and cause a Printhead crash, thus causing many media jam failures to be reported as head crashes.

- 1 Did the media jam occur when loading media?
  - If the client has had media jams, it is common for pieces of media to get stuck in the media path. Clear the media path.

**When clearing a media jam, sometimes media is stuck in the paper path. To clear this, you must lift the Pinchwheel Lever and insert thicker media into the paper path to push out the media that is still stuck there.**

- 2 Is the customer using non-HP media?
  - The use of non-HP media can easily be the cause of media jams and head crashes (especially head crashes because HP media is specially formulated to avoid cockle, one of the primary causes of head crashes). If the media is not HP approved, advise the customer to use HP media and check to see if the problem is now solved.
- 3 Check that the Vacuum Fan works correctly.

## Troubleshooting Shutdowns

If a shutdown occurs, you will get the message "Switch Power Off" followed by:

- Check Printhead Cleaner Path.
- Check Paper Path.
- Check Printhead Path (followed by (1), (2) or (3)).

A shutdown in each path will require different steps to resolve the problem as explained as follows.

**In each case, make sure that you power OFF the printer before attempting any procedures to resolve the problem.**

### Printhead Cleaner Path

- 1 Open the right door of the printer and check for any visible obstacles restricting the movement of the Service Station. Manually move the Service Station, checking for smooth and free movement.

### Paper Path

- 1 Open the Window and check for any visible obstacles restricting the movement of the Drive Roller. If there is a wrinkled mass of media inside the paper path, lift the Pinch wheels (using the Media Load Handles) and clear the obstruction.
- 2 If this shutdown happens at the end of a Roll of Media, it could be because the media is stuck firmly to the Roll. Lift the Pinch wheels (using the Media Load Handles) and pull the media clear.
- 3 Replace media spindle if broken.
- 4 Replace the Media-Axis Motor ⇒ Page 8-62.

### Printhead Path

When a shutdown occurs in the Printhead path, you will get the message "Switch Power Off / Check Printhead Path (\*). The (\*) will be a number, which will give an indication on where the failure occurred:

#### PWM Shutdown (1) and Energy Shutdown (3)

- 1 Clean Slider Rods and Apply Oil along the complete axis of the Slider Rods. After applying the Oil, perform the Scan-Axis Test ⇒ Page 4-7 and check that the values are within the given limits.
- 2 Replace the Scan-Axis Motor ⇒ Page 8-59.

#### Velocity Shutdown (2)

- 1 Open the Window and check for any visible obstacles restricting the movement of the Carriage Assembly. Try and move the Carriage Assembly manually, checking for smooth and free movement.
- 2 Check that the Encoder Strip is clean. If necessary, clean Encoder Strip using a damp cloth.

## Vacuum suction much lower at high altitudes

At altitudes above 3,000 meters, the vacuum force holding down the media will be lower, therefore the media will not be held in place properly causing:

- Ink Smearing on the Media.
- Printhead crashes against the Media.
- Cut Sheet loading problems (high probability).
- Roll Media loading problems (low probability).

PRINTER LIMITATION - NO SOLUTION AVAILABLE.

## Banding at variable extreme environmental conditions

Since the Accuracy Calibration has been done at normal environmental conditions, printing in extreme environmental conditions will cause banding because the advance of the Drive Roller does not correspond to the same conditions that the calibration was done in. To solve the problem, try the following:

Perform the Accuracy Calibration in the new environmental conditions (Refer to the User's Guide).

## Printhead Crashes/Smears on High Density Prints Using Coated Media

High density prints can cause cockle mainly on HP Coated Media. This causes two main problems:

1. Cockling in the borders - Because the printer places too much ink on the Coated Media, the borders of the print become raised, causing the Printhead to crash against the media. To solve the problem, try the following:
  - Change the paper margins to 15mm, either in the Front Panel or in the Driver. If the customer is printing PostScript images, send them a PPD file containing the extended margins of 15mm.
2. Cockling within the print - If the Printer places too much ink within the print, the media starts to ripple, causing the Printhead to smear against the media. To solve the problem, try the following:
  - Check in the Front Panel if **Ink Limiting** is ON or OFF. If Ink Limiting is OFF, turn it ON.
  - Never use HP Coated Media for High Density prints. As a substitute use HP Heavy Coated Media.

## **Banding due to Ink Cartridge replacement while printing**

A user has removed the Ink Cartridge while the printer was printing, which has caused the printer to stop. If the user does not replace the Ink Cartridge immediately, when the printer starts to print again, a band will appear in the position where the printing restarted. This is because the wet ink interacts with the dried ink on the media causing the band to appear. To solve the problem, try the following:

- Do NOT remove the Ink Cartridge while the Printer is Printing. Only replace/remove Ink Cartridges in between Prints.
- If the Ink Cartridge was replaced due to the "Empty" status on the Front Panel, then advise the customer to replace the Ink Cartridge when the "Very Low" status is showing on the Front Panel.
- Reprint the file (without remove the Ink Cartridge).

## **34" Rice Paper not supported**

Roll length is 34" (Non-standard) and the pinch wheels can't control edge of media causing ink smears and Printhead crashes in middle of prints with or without area fills.

PRINTER LIMITATION - NO SOLUTION AVAILABLE.

## **Cut Sheet rice paper loading failure**

Thin rice paper is sucked into the Center Platen grooves and Linear Blade Ridge. This implies that the friction between the Center Platen and the rice paper becomes higher than between the Overdrive wheels and the paper. This effect make it almost impossible to load the rice paper correctly because the Vacuum is too high.

PRINTER LIMITATION - NO SOLUTION AVAILABLE.

## **Worm marks on HP Coated media with light area fills**

Light bands (S-shaped) in Paper axis direction where light area fills are printed, causing unacceptable Image Quality defect.

- Print the Service Configuration Print and check if the level of Humidity is very low (below 30%). Increasing humidity may help in reducing the severity of the problem.

**The media is causing the problem and NOT the Printer. Do not attempt to try and replace Printer parts to solve this problem.**

## Solving Media-Handling Problems

### The Front Panel Keeps Indicating that Media Is Misaligned or Incorrectly Positioned

#### Roll media

- The roll may be loaded the wrong way. The paper should load over the roll toward you.
- Check that the paper is correctly loaded onto the spindle.
- The paper may be loaded at an angle. The right-hand edge must be aligned with the blue line on the Print Platen.

**Ensure that the paper is wrapped tightly on the roll. This is a very important step to remember because if this is not done, the media may be loaded at an angle, causing the media to be rejected.**

#### Sheet media

- It must be loaded with the right-hand edge against the blue line on the Print Platen.
- The media may be crumpled or warped or may have irregular edges.
- If hand-cut media is used, the edges may not form a right-angle or they may be rough. If possible, hand-cut media should not be used. Only purchased sheet media should be used in the Printer.
- If the overdrive is covered in dust, it will have problems picking up the sheet media during the load process. Clean the Overdrive using the Turn Drive Roller Service Utility ⇒ Page 4-53.

## Using the Buzzer at Power-up to Troubleshoot

When the Printer is powered up, it doesn't make a "Beeping Sound" until it is completely powered-up and ready to use. If there is a beep during the power-up sequence, this may signify that there is a problem within the Electronics Module. The following table will help you to use the "Beeping Sound" to diagnose certain problem:

Number of Beeps	Problem Description	Corrective Action
1	Processor absent	<ul style="list-style-type: none"> <li>■ Replace the Main PCA ⇒ Page 8-74.</li> </ul>
2	Faulty Main PCA or PSU	<ul style="list-style-type: none"> <li>■ Replace the Main PCA ⇒ Page 8-74.</li> <li>■ Replace the PSU ⇒ Page 8-78.</li> </ul>
3	Faulty Memory Module	<ul style="list-style-type: none"> <li>■ Check that the Memory Module is installed correctly.</li> <li>■ Try installing the Memory Module in the other Memory slot and check if the problem reappears.</li> <li>■ If the problem reappears, replace the Memory Module ⇒ Page 8-72.</li> <li>■ If the problem does NOT reappear, then the original slot could be faulty. In this case, replace the Main PCA ⇒ Page 8-74.</li> </ul>
4	Faulty Video Card (not used)	<ul style="list-style-type: none"> <li>■ Replace the Main PCA ⇒ Page 8-74.</li> </ul>
5	Faulty PCI Card	<ul style="list-style-type: none"> <li>■ Replace the Main PCA ⇒ Page 8-74</li> </ul>
6	BIOS Damaged	<ul style="list-style-type: none"> <li>■ Replace the Main PCA ⇒ Page 8-74</li> </ul>
7	Motherboard damaged	<ul style="list-style-type: none"> <li>■ Replace the Main PCA ⇒ Page 8-74</li> </ul>
8	Hard Disk Drive damaged or missing	<ul style="list-style-type: none"> <li>■ Remove the Main PCA Cover and (with the Printer switch On) check that the HDD is spinning (you should feel it spinning when you touch it or at least hear it spinning). If the HDD is <b>not</b> spinning, then it could be damaged. In this case, replace the HDD ⇒ Page 8-76.</li> <li>■ Make sure that ALL cables connected to the HDD are not damaged and are connected correctly.</li> <li>■ Replace the HDD ⇒ Page 8-76</li> <li>■ Replace the Main PCA ⇒ Page 8-74</li> </ul>

## Using the Power-up Sequence to Troubleshoot

When the Printer is powered up, it performs the Boot-UP sequence which initializes the major components of the Printer. If for some reason the Boot-Up sequence fails because a component has failed to initialize, the following explanations will help you to locate the failing component:



Step	Initialization Process
BULNEX KERNEL BOOT	
30	rc.sysinit rerun through initlog.
29	<ul style="list-style-type: none"> <li>■ Environmental variables PATH, NETWORKING, HOSTNAME set.</li> <li>■ Source /etc/init.d functions.</li> </ul>
28	<ul style="list-style-type: none"> <li>■ Fix console loglevel.</li> <li>■ Mount /proc.</li> <li>■ Dismount the initrd, if necessary.</li> <li>■ Configure kernel parameters.</li> </ul>
27	Set the system clock.
26	Load keymap.
25	Load system font.
24	Start up swapping.
23	<ul style="list-style-type: none"> <li>■ Set the hostname.</li> <li>■ Initialize USB controller and HID devices</li> </ul>
22	<ul style="list-style-type: none"> <li>■ Set variables for options to be later used for filesystem check</li> <li>■ Turn Off DMA on CD-ROMs</li> <li>■ Turn On Hard Disk optimization</li> </ul>
21	Perform file system check on root volume.
20	Update quotas if fsck was run on root
19	Setup pnp



Step	Initialization Process
18	<ul style="list-style-type: none"> <li>■ Remount the root filesystem read-write.</li> <li>■ LVM initialization.</li> <li>■ Clear mtab.</li> <li>■ Enter root, /proc and (potentially /proc/bus/usb and devfs into mtab.</li> <li>■ Remove /lib/modules/preferred and /lib/modules/default.</li> <li>■ Tweak isapnp settings if needed.</li> <li>■ Load sound modules if the need persistent DMA buffers.</li> </ul>
17	<ul style="list-style-type: none"> <li>■ Load modules from /etc/rc.modules.</li> <li>■ File system check.</li> <li>■ Add raid devices.</li> </ul>
16	<ul style="list-style-type: none"> <li>■ Setup Logical Volume Management.</li> <li>■ Check filesystems on all volumes found on /etc/fstab.</li> </ul>
15	Mount local filesystems.
14	Check remaining quotas other than root.
13	Enable local filesystem quotas.
12	<ul style="list-style-type: none"> <li>■ Configure machine if necessary (if the respective configure files exist).</li> <li>■ Reread in network configuration data.</li> </ul>
11	<ul style="list-style-type: none"> <li>■ Clean out /etc, (w/u)tmpx files, /var.</li> <li>■ Reset pam_console permissions.</li> <li>■ Cleanup utmp/wtmp.</li> <li>■ Delete X locks.</li> <li>■ Delete VNC and X locks.</li> <li>■ Delete Postgres sockets.</li> <li>■ Turn On swap in case we swap to files.</li> </ul>
10	<ul style="list-style-type: none"> <li>■ Initialize the Serial Ports.</li> <li>■ If a SCSI tape has been detected, load the st module unconditionally.</li> <li>■ Load usb storage to match most other things.</li> <li>■ If ide-scsi is required, load it.</li> <li>■ Generate a header that defines the boot kernel.</li> </ul>
9	<ul style="list-style-type: none"> <li>■ Dump the syslog ring in /var/log/dmesg.</li> <li>■ Keep kernel symbols in /var/log/ksyms.</li> <li>■ Create the crash indicator flag to warn on crashes, offer fsck with timeout.</li> </ul>
8	Export this variable BOOT_PART and INSTALL_PART.

Step	Initialization Process
PRINT APPLICATION STARTING POINT	
7	IO kernel mode initialization (basically).
6	Printer Application Infrastructure startup.
5	Printer IO startup.
4	Front Panel application startup (but wait for engine launching, i.e. Front Panel is not cleared yet).
3	Engine startup, start EE and Mechanical initialization.
2	HPGL/PS parsers startup.
1	All subsystems launched. Wait for Front Panel application to clear the Front Panel and start signaling the initialization sequence.

**Corrective Actions for Power-Up Problems**

- 1** If the Printer's Power-Up process stops when the front panel is displaying the number **17**, this indicates that there is a problem with the file system on the Printer's Hard Disk Drive, so the Printer is checking the whole file system and making any necessary corrections. This problem can arise when there has been a power cut while the Printer was switched On, or if there is a physical problem with the Hard Disk Drive.

Checking the whole file system normally takes about half an hour (but could take much longer). There is nothing that can be done to speed up the file checking process. If you turn Off the Printer during the checking process, the file system check will restart whenever you turn it On again.

If you experience this problem repeatedly when there has been no power cut, then this could mean that the Hard Disk Drive is faulty. In this case, replace the Hard Disk Drive ⇒ Page 8-76.

- 2** If the printer's start-up process stops when the front panel is displaying any number between **1** to **30**, then try the following:
  - Switch the Power OFF from the back of the Printer and disconnect the Power cord. Reconnect the power cord and power On the Printer.
  - If the Printer continues to stop during the power-up process, replace the Hard Disk Drive ⇒ Page 8-76.

## Using the Power Switch LEDs to Troubleshoot

In certain circumstances, the LEDs located on top of the power switch (located at the rear of the Printer) can help to troubleshoot the Printer. The LEDs can either be ON or Off and using different combinations can indicate different problems:



Make sure you look directly at the LEDs and not at an angle.

Amber is on the Left  
Blue is in the center  
Green is on the Right

- 1 When only the **Amber LED** is On:
  - The Printer has been switched Off from the Front Panel (after having pressed the On/Off button).
  - The Power Supply Unit only delivers a 5 V "Standby"; power that is needed to restart the Printer after the Front Panel On/Off button is pressed (the Formatter/Main PCA will initiate the Printer to start).
- 2 When the **Blue LED** is On: Deliver standard "ATX" power for the Electronics Module PCAs (+12V, +5V, -5V, -12V, etc...). All the functions of the Electronics Module are fully operational (EWS, etc...).
- 3 When the **Green LED** is On: Deliver "analog" 24V and 42V to enable printing.

The Printer monitors and reports different signals: PSU fan issues, 24V and 42V delivery failures (specific System Error reported pointing to PSU failure).

PSU Blue LED Status	PSU Green LED Status	Left LED (on Front Panel) Status	Printer Status
ON	OFF	Red (Front Panel Black)	Standby (with Embedded Web Server up and running)
ON	OFF	Green (flashing)	Initializing
ON	ON	Green	Ready (but not printing)
ON	ON	Green	Printing or preparing to print
OFF	ON	Any	Not possible
ON	ON	Red (Front Panel Black)	Not possible

## Using the PCA LEDs to Troubleshoot

In certain circumstances, the LEDs located on the Interconnect PCA and PrintMech PCA can help to troubleshoot the Printer. The LEDs can either be ON or Off and using different combinations can indicate different problems:

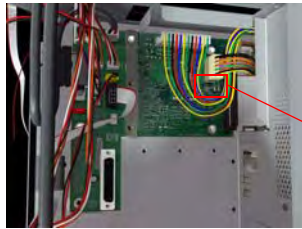

**Interconnect PCA**

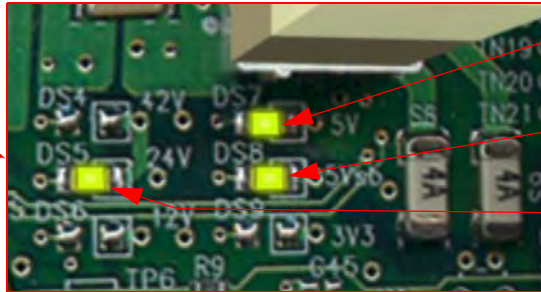

5V

5Vsb

24V

- 5V** - Comes from the PSU after the fuse on Interconnect PCA. Used to power On Front Panel and some Interconnect Electronics. Should be ON at the same time as Blue Power Switch LED.
- 5Vsb** - Comes from the PSU after the fuse on Interconnect PCA. Used to power On the Printer from the Front Panel. Should be ON at the same time as Blue or Amber Power Switch LED.
- 24V** - Comes from the PSU after the fuse on Interconnect PCA. Used to power the Carriage PCA. Should be ON at the same time as Green Power Switch LED.

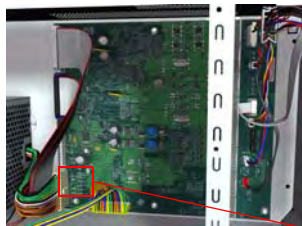

**PrintMech PCA**

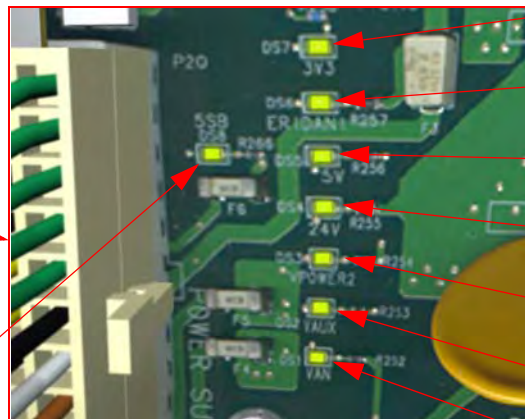

3V3

ERIDANI

5V

24V

VPOWER2

VAUX

VAN

5SB

- 5Vsb** - Comes from the PSU after the fuse on PrintMech PCA.
- 3V3** - Comes from the Power Supply Unit.
- 5V** - Comes from the Power Supply Unit.
- ERIDANI** - Specific power line from PSU which powers ERIDANI chip after a fuse on PrintMech.
- 24V** - Comes from the PSU after a fuse on the PrintMech PCA.
- VPOWER2** - Comes from the PSU (42V) after a fuse on the PrintMech PCA.
- VAUX** - Comes from the PSU (12V) after a fuse on the PrintMech.
- VAN** - Is generated in the PrintMech PCA (reference tension is generated from ERIDANI IC). The value is around 5V. If this LED is **not** ON, and the others are ON, this indicates that there is high probability that the PrintMech PCA is defective.

**1** If the Printer cannot be turned ON:

Signal	LED on Interconnect PCA	LED on PrintMech PCA	Power Switch LED	Corrective Action
5Vsb	OFF	ON	Amber	<ul style="list-style-type: none"> <li>Check the connection between the PSU and the Interconnect PCA.</li> <li>If connection OK, replace the Interconnect PCA ⇒ Page 8-64.</li> </ul>
5Vsb	ON	OFF	Amber	<ul style="list-style-type: none"> <li>Check the connection between the PSU and the PrintMech PCA.</li> <li>Make sure that ALL cables between the PSU and PrintMech are not damaged and are connected correctly.</li> </ul>
5Vsb	OFF	OFF	Amber or no LED	<ul style="list-style-type: none"> <li>Check the connection between the PSU and the PrintMech PCA and Interconnect PCA.</li> <li>If connection OK, check that power reaches the PSU (check the power outlet).</li> <li>If power reaches PSU, replace the PSU ⇒ Page 8-78.</li> </ul>

**2** If the Printer starts (after having pressed the ON button on the Front Panel) but the front Panel remains black:

Signal	LED on Interconnect PCA	LED on PrintMech PCA	Power Switch LED	Corrective Action
5V	OFF	ON	Blue	<ul style="list-style-type: none"> <li>Check the connection between the PSU and the Interconnect PCA.</li> <li>If connection OK, replace the Interconnect PCA ⇒ Page 8-64.</li> </ul>
5V	ON	ON	Blue	<ul style="list-style-type: none"> <li>Check the connection between the Front Panel and the Interconnect PCA.</li> <li>If connection OK, replace the Interconnect PCA ⇒ Page 8-84 and the Front Panel ⇒ Page 8-20.</li> </ul>

**3** The Printer is up and running, or may have a System Error at the end of the power-up sequence. For the Carriage PCA connection, perform the Scan-Axis Test ⇒ Page 4-7:

Signal	LED on Interconnect PCA	LED on PrintMech PCA	Power Switch LED	Corrective Action
5V	OFF	ON	Blue	<ul style="list-style-type: none"> <li>■ Check the connection between the PSU and the Interconnect PCA.</li> <li>■ If connection OK, replace the Interconnect PCA ⇒ Page 8-64.</li> </ul>
24V	ON	ON	Blue and Green	<ul style="list-style-type: none"> <li>■ Check the System Error that is produced and run the corresponding Diagnostic Test (either Scan-Axis or Media-Axis Test).</li> </ul>
24V	OFF	OFF	Blue and Green	<ul style="list-style-type: none"> <li>■ Check the connection between the PSU and the PrintMech PCA and Interconnect PCA.</li> <li>■ If connection OK, run the Electronics Module Test to further diagnose the problem.</li> </ul>
24V	OFF	ON	Blue and Green	<ul style="list-style-type: none"> <li>■ Check the connection between the PSU and the Interconnect PCA.</li> <li>■ If connection OK, run the Electronics Module Test to further diagnose the problem.</li> </ul>
24V	ON	OFF	Blue and Green	<ul style="list-style-type: none"> <li>■ Check the connection between the PSU and the PrintMech PCA.</li> <li>■ If connection OK, run the Electronics Module Test to further diagnose the problem.</li> </ul>

**4** On the PrintMech PCA, if the 3V3 LED is ON, 5V LED is ON, ERIDANI LED is ON, VAUX LED is ON and the VAN LED is OFF, then try the following:

- Run the Electronics Module Test to further diagnose the problem.
- Replace the PrintMech PCA ⇒ Page 8-84.

**5** If the Power Switch LED is Green and the 3V3 LED is ON, 5V LED is ON, ERIDANI LED is ON, VAUX LED is ON, VAN LED is ON and the VPOWER2 LED is OFF, then try the following:

- Check the connection between the PSU and the PrintMech PCA.
- Run the Electronics Module Test to further diagnose the problem.
- Replace the PrintMech PCA ⇒ Page 8-84.

## How to Interpret the Service Information Pages

The Service Information Pages contain the following information:

- Current Information.
- Printer Usage Information.
- Event Logs.
- Calibration Status.
- Network and I/O Configuration.

It is possible to print the Service Information Pages either through the Front Panel or through the Embedded Web Server:

- Front Panel: Setup menu ⇒ Information Menu ⇒ Internal Prints ⇒ Print Service Information.
- Embedded Web Server: Information ⇒ Event Log ⇒ Advanced

Even the Printer cannot print, the Information Pages are still accessible through the Embedded Web Server.

HP Designjet 4000 Embedded Web Server interface showing the Event Log page. The page title is "Event log". A red box highlights the "Advanced" button in the top right corner of the table area. A red arrow points from a text box on the left to this button.

Severity	Error code	Firmware	Internal error	Media usage	Date
#1	1	86:01	GW_3.1.1.2	0x18010001	11 530299 sqtm Feb 25, 2005 3:22 PM
#2	1	86:01	GW_3.1.1.2	0x18010001	11 530298 sqtm Feb 25, 2005 3:22 PM
#3	1	79:44	A_1_34.34.3	0x0abeface	3:179894 sqtm Nov 26, 2004 11:37 AM
#4	1	98:01	A_1_34.34.3	0x18010001	3:179894 sqtm Nov 10, 2004 4:21 PM
#5	1	79:44	A_1_34.34.3	0x0abeface	0:924937 sqtm Nov 10, 2004 3:46 PM
#6	1	78:03	A_1_34.34.3	0x14010003	0:000000 sqtm Oct 27, 2004 2:41 PM
#7	1	71:19	A_1_34.34.3	0x17080006	11 720621 sqtm Oct 27, 2004 2:17 PM
#8	1	71:19	A_1_34.34.3	0x17080006	11 720621 sqtm Oct 27, 2004 2:13 PM

EWS Event Log Page -  
Advanced Button

### Main Characteristics

- Each Service Information page fits on a sheet of A4/A-size media (so that it can be faxed if necessary).
- Only available in English (except the current information page).
- From the Front Panel, you can choose to print ALL pages or just select the specific pages that are needed. If ALL pages are printed:
  - Nesting is turned ON automatically (and turned OFF once all the pages have been printed).
  - Nesting cannot be mixed with other jobs in the queue.
- Each page can be printed from the Web browser when using the Embedded Web Server.
- Each page can be sent by e-mail from the Web Browser when using the Embedded Web Server (File ⇒ Send ⇒ Page by E-mail).
- You can see the same information through the Front Panel or the Embedded Web Server.

## Current Media, Printhead and Ink Information

This page contains the following information:

- Current Printer Configuration.
- Paper Loaded Information.
- Current Printhead Kit Information.
- Current Ink cartridge Information.

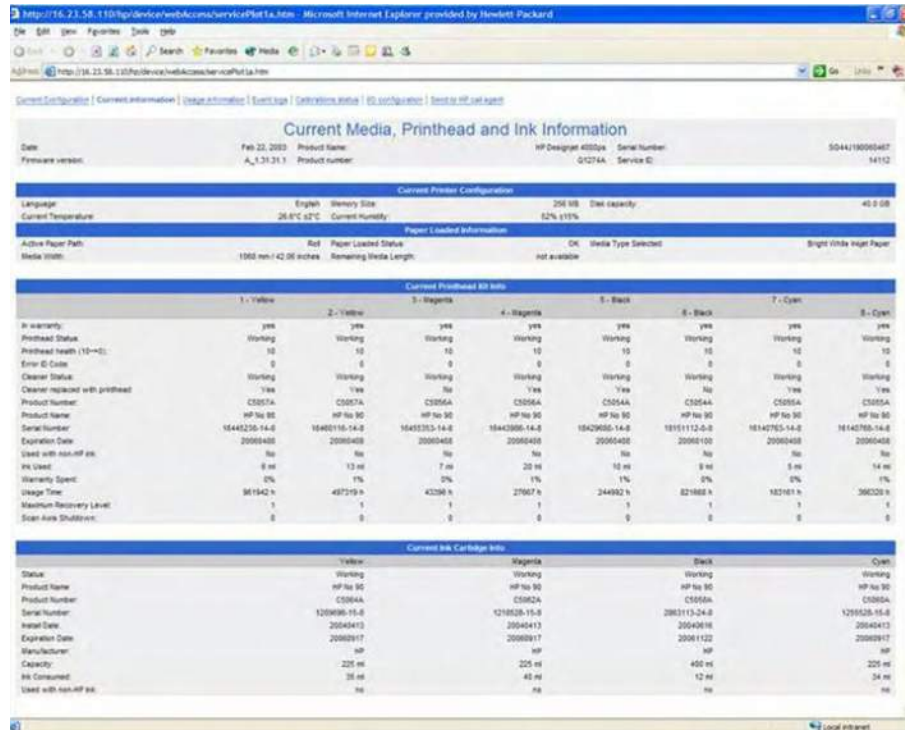

The first two lines are available at the beginning of each Service Information Page and contains standard information (like Service ID, Firmware version).

### Items of Interest

The items explained below are useful to know:



- **Temperature and Humidity:** The sensors are located on the ISS PCA (at the top of the Ink Cartridges).
- **Active Paper Path:** Whether Roll or Cut Sheet is currently loaded.
- **Remaining Media Length:** Currently this will show "not available" all the time since the media length tracking function is not available.



1 - Yellow	
In warranty:	yes
Printhead Status:	Working
Printhead health (10→0):	10
Error ID Code:	0
Cleaner Status:	Working
Cleaner replaced with printhead:	Yes
Product Number:	C5057A
Product Name:	HP No 90
Serial Number:	16445238-14-8
Expiration Date:	20060408
Used with non-HP ink:	No
Ink Used:	6 ml
Warranty Spent:	0%
Usage Time:	961942 h
Maximum Recovery Level:	1
Scan Axis Shutdown:	0

- **Printhead Status:** 'OK', 'Missing', 'Reset', 'Replace' or 'Remove'.
- **Expiration Date:** Manufacture date (date marked on the actual Printhead) + 24 months.
- **Used with non-HP ink:** Can be reset to NO only when a new Printhead has been installed and neither the Ink Tubes nor the Ink Cartridges have been marked as "Used with non-HP ink = Yes".
- **Warranty spent:** Percentage (%) versus 1000ml.
- **Scan Axis Shutdown:** Corresponds to a media jam.

1 - Yellow	
In warranty:	yes
Printhead Status:	Working
Printhead health (10→0):	10
Error ID Code:	0
Cleaner Status:	Working

- **Printhead Health:** This represents the number of nozzles out of service during the last drop detection that was performed.

Number of Nozzles Out	Printhead Health
< 5	10
> or = 5 and < 10	9
> or = 10 and < 20	8
> or = 20 and < 30	7
> or = 30 and < 50	6
> or = 50 and < 70	5
> or = 70 and < 100	4
> or = 100 and < 150	3
> or = 150 and < 200	2
> or = 200 and < 400	1
> or = 400	0

	Yellow
Status:	Working
Product Name	HP No 90
Product Number:	C5064A
Serial Number:	1289696-15-8
Install Date:	20040413
Expiration Date:	20080917
Manufacturer:	HP
Capacity:	225 ml
Ink Consumed:	35 ml
Used with non-HP Ink:	no

- **Cartridge Status:** 'OK', 'Missing', 'Low', 'Very Low', 'Empty', 'Reset' or 'Replace'.
- **Expiration Date:** Manufacture date (date marked on the actual Ink Cartridge) + 30 months.
- **Install Date:** Corresponds to the internal date of the Printer (RTC) when the Ink Cartridge was installed for the first time.
- **Capacity:** Total capacity of the Ink Cartridge.

### Printer Usage Information

This page contains the following information:

- Printer Usage.
- Usage per Printhead Slot.
- Usage per Cartridge Slot.
- Media Usage per Media Type.
- Component Usage.
- Spittoon Usage.
- Preventive Maintenance Usage.

Product Number:	C5057A	C5057A	C5056A	C5056A	C5054A	C5054A	C5055A	C5055A
Product Name:	HP No 90	HP No 90	HP No 90	HP No 90	HP No 90	HP No 90	HP No 90	HP No 90
Printheads Used:	0	0	0	0	0	0	0	0
Total Insertions:	1	1	1	1	1	1	1	1

Usage per Cartridge Slot				
	1 - Yellow	2 - Magenta	3 - Black	4 - Cyan
Product Name:				
Product Number:				
Usage:	Cartridges /	Cartridges /	Cartridges /	Cartridges /

Media Usage per Media Type	
Productivity Photo Gloss (HP)	1.04 m <sup>2</sup> / 11.2 ft <sup>2</sup>

Component Usage			
Belt usage (# cycles):	318	Motor usage (# cycles):	318
Trailing cable usage (# cycles):	318	Tube usage (# cycles):	318
		Carriage usage (# cycles):	318
		Tube used with non-HP ink:	No

Spittoon Usage (L to R)					
Spittoon 1	0.00 cc	Spittoon 2	0.00 cc	Spittoon 3	0.00 cc
Black cleaner spittoon 1	0.08 cc	Black cleaner spittoon 2	0.08 cc	Spittoon 4	0.00 cc

Preventative maintenance Usage	
Preventive maintenance kit #1	0
Preventive maintenance kit #2	0

### Media Used Sections

- Total media used in the Printer.

Printer Usage			
Total printed media:	12.12 m <sup>2</sup> / 130.4 ft <sup>2</sup>	Total number of prints:	31

- Media used for each media type.

Media Usage per Media Type			
High-Gloss Photo Paper (HP)	10.30 m <sup>2</sup> / 110.9 ft <sup>2</sup>	Productivity Photo Gloss (HP)	6.92 m <sup>2</sup> / 74.4 ft <sup>2</sup>
Bond Paper (HP)	6.81 m <sup>2</sup> / 73.3 ft <sup>2</sup>		

It is possible that the sum of the media used for each media type is lower than the total amount of media used in the Printer. This is because only the total media used in the Printer is saved in the backup EEROM which is located in the ISS PCA. When the Hard Disk Drive is replaced, the total media used per media type is reset to zero (0), but the total media used is recovered from the backup EEROM.

### Printhead Section

The Printheads currently being used are not counted.

- **Total Insertions:** This is linked with the crane of the Ink Supply Tubes. When the Ink Supply Tubes are replaced, the total insertions amount will be reset to zero (0).

Usage per Printhead Slot								
	Slot 1	Slot 2	Slot 3	Slot 4	Slot 5	Slot 6	Slot 7	Slot 8
Color:	Yellow	Yellow	Magenta	Magenta	Black	Black	Cyan	Cyan
Product Number:	C5057A	C5057A	C5056A	C5056A	C5054A	C5054A	C5055A	C5055A
Product Name:	HP No 90	HP No 90	HP No 90	HP No 90	HP No 90	HP No 90	HP No 90	HP No 90
Printheads Used:	0	0	0	0	0	0	0	0
Total Insertions:	1	1	1	1	1	1	1	1

### Cartridge Section

The Ink Cartridges currently being used are not counted.

- This section is split by product name and number for each color as we have different Ink Cartridge sizes. The sample below does not represent the reality as we only have one size of Black Ink Cartridge (400cc).

3 - Black	
Product Name:	HP No 90
Product Number:	C5059A
Usage:	2 Cartridges / 3.816380 cc
Product Name:	HP No 90
Product Number:	C5058A
Usage:	1 Cartridges / 14.144599 cc

### Preventive Maintenance Section

Once the value reaches 100%, the corresponding Preventive Maintenance Kit should be used. For further details, refer to Chapter 9 - Preventive Maintenance.

Preventative maintenance Usage	
Preventive maintenance kit #1	0 %
Preventive maintenance kit #2	0 %

### Component Usage

One cycle is counted when the Carriage makes one movement to the left of the Printer and then returns to the right.

- **Tube used with non-HP ink:** This is set to **Yes** as soon as the Printer detects that at least one Ink Cartridge was used with third-party ink. This cannot be reset to **No** (because it is part of the ISS EEROM), except when:
  - The Ink Supply Tubes are replaced (not under warranty).
  - The Printer detects that the Ink Cartridge being used no longer uses third-party ink.

Component Usage			
Belt usage (# cycles):	2075	Motor usage (# cycles):	2075
Carriage usage (# cycles):	2075	Trailing cable usage (# cycles):	2075
Tube usage (# cycles):	2075	Tube used with non-HP ink:	No

### Spittoon Section

This section contains information on the different Spittoons located in the Printer.

Spittoon Usage (Left to Right)			
Spittoon 1	0.00 cc	Spittoon 2	0.00 cc
Spittoon 3	0.00 cc	Spittoon 4	0.00 cc
Black cleaner spittoon 1	0.48 cc	Black cleaner spittoon 2	0.48 cc

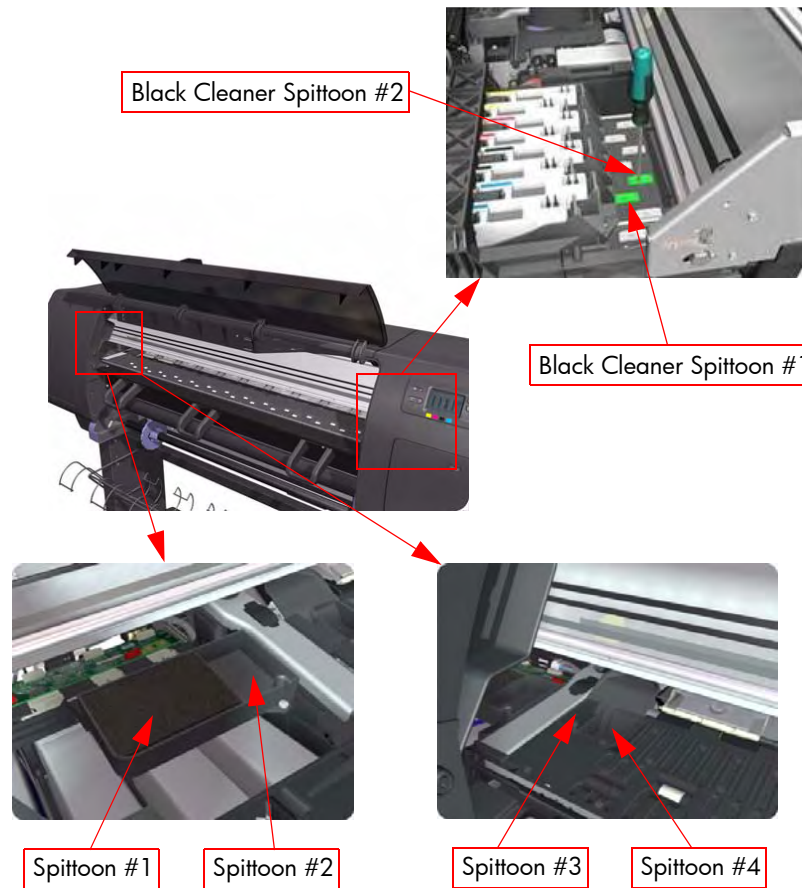

## Event Logs

This page contains the following information:

- Last 20 System Error Codes (which prevented the Printer from booting).
- Last 20 System Warnings (which did not prevent the Printer from booting, but which required the user to acknowledge the problem).
- Printhead Error log.

Event Logs							
Date:	Mar 4, 2005	Product Name:	HP DesignJet 4000	Serial Number:	S04631901M		
Firmware version:	GW_3.1.1.2	Product number:	G1273A	Service ID:	14309		
System Errors							
Event #	Severity	Error Code	Internal Code	FW Version	Media Usage	Line	Date
1	severe	06:01	0x10010001	GW_3.1.1.2	11.530299	ScanAxis/Gread/Wall.cpp:666	20050225
2	severe	86:01	0x10010001	GW_3.1.1.2	11.530299	Carriage/ServoMotor.c:1537	20050225
3	severe	75:04	0x0BAEFACE	A_1.34.34.3	3.178994	AnalogSensor/Common.cpp:620	20041126
4	severe	86:01	0x10010001	A_1.34.34.3	3.178994	ScanAxis/Gread/Wall.cpp:666	20041110
5	severe	79:04	0x0BAEFACE	A_1.34.34.3	0.934027	AnalogSensor/Common.cpp:620	20041110
6	severe	79:03	0x14010003	A_1.34.34.3	0.000000	rpcLayer.c:766	20041027
7	severe	71:19	0x17000006	A_1.34.34.3	11.720621	NvmCompound.cpp:1029	20041027
8	severe	71:19	0x17000006	A_1.34.34.3	11.720621	NvmCompound.cpp:1029	20041027
System Warnings							
Event #	Severity	Error Code	Internal Code	FW Version	Media Usage	Line	Date
1	advisory	81:01	0x21080002	GW_3.1.1.2	10.985461	pm_util.c:689	20050226
2	advisory	26:0101	0x10020002	A_1.34.34.3	3.178994	inkSupply/Narvthal.cpp:5491	20041112
3	advisory	61:04.1	0x21010009	A_1.34.34.3	0.934037	ink.c:1005	20041100
4	advisory	26:3:01	0x10020005	A_1.34.34.3	11.720621	inkSupply/Narvthal.cpp:5494	20041027
Printhead Error Log							
	Printheads ago	Serial Number	Status	Usage time	% Ink Used	Max Recovery	Error Code
1 - Yellow	0	16455695-33-8	0	2 h	0	1	0
	1	16462452-33-8	0	2 h	0	1	0
2 - Yellow	0	16462452-33-8	0	2 h	0	1	0
	1	16455695-33-0	0	2 h	0	1	0
3 - Magenta	0	16461097-33-8	0	2 h	0	1	0
	1	16462034-33-8	0	2 h	0	1	0
4 - Magenta	0	16462034-33-8	0	2 h	0	1	0
	1	16461097-33-8	0	2 h	0	1	0
5 - Black	0	10429970-25-0	0	2 h	0	1	0
	1	10429727-25-8	0	2 h	0	1	0
6 - Black	0	10429727-25-8	0	2 h	0	1	0
	1	10429970-25-8	0	2 h	0	1	0
7 - Cyan	0	16455974-33-8	0	4 h	0	1	0
8 - Cyan	0	16455695-33-0	0	4 h	0	1	0

## System/Warning Error

- The **Line** and **Internal Code** do not provide much information, but are useful in the case of escalating a problem to the division (different internal error codes can point to the same error code (e.g. 01.10:10)).
- **Media Usage** (in square meters) and **Date** (from the Printer's Internal Clock (RTC)) help you to understand if the Printer has been used (media usage) and how much time has passed since the last error.

## Printhead Error Log

- **Printheads ago:** History of the last three Printheads used ('0' represents the current Printhead used).
- **Status:** '0' = Working, '1' = No Pen Detected, '2' = Replace, '4' = Reseat, '8' = Remove.
- **% Ink Used:** Percentage of the Warranty life (1000cc).
- **Error Code:** Specific error code generated by the Printer when the Printhead has been replaced.
- **Max Recovery:**
  - 0: No manual Printhead recovery has been performed on the Printhead.
  - 1 or higher: At least one Printhead recovery has been performed.

Printhead Error Log							
	Printheads ago	Serial Number	Status	Usage time	% Ink Used	Max Recovery	Error Code
1 - Yellow	0	16455695-33-8	0	2 h	0	1	0
	1	16462452-33-8	0	2 h	0	1	0
2 - Yellow	0	16462452-33-8	0	2 h	0	1	0
	1	16455695-33-8	0	2 h	0	1	0

## Calibrations Status

This page contains the following information:

- General Calibrations (performed by Service Engineers).
- Media Specific Calibrations (performed by the User).

Information on these 3 Calibrations will be added in Firmware Version 4.x.x.x

In Firmware Version 4.x.x.x the following text will also be added here:  
"3 Calibrations are not reported within this list: 'Blue Line Calibration', 'Carriage PCA Setup' and 'Vacuum Fan'."

Calibrations Status					
Date:	Aug 23, 2004	Product Name:	HP DesignJet 4000ps	Serial Number:	5G44J190060868
Firmware version:	A_1.32.32.15	Product number:	Q1274A	Service ID:	14112
General Calibrations					
LED Gain Offset	not done	Line Sensor to Black	done	Drop Detector	not done
Paper Advance	done	Printhead Alignment	done		
Media-specific Calibrations					
Vendor	Media Name	Color	Paper Advance Text/drawing	Paper Advance Graphics	
HP	High-Gloss Photo Paper	pending	pending	calibrated	
HP	Inkjet Bond Paper	pending	pending	pending	
HP	Canvas	pending	pending	pending	
HP	Special Clear Film	pending	pending	pending	
HP	Coated Paper	pending	pending	pending	
HP	Productivity Photo Gloss	pending	pending	pending	
HP	Heavyweight Coated Paper	pending	pending	pending	
HP	Matte Film	pending	pending	pending	
HP	Bright White Inkjet Paper	pending	pending	pending	
HP	Natural Tracing Paper	pending	pending	pending	
HP	Super Heavy Coated Paper	pending	pending	pending	
HP	Translucent Bond	pending	pending	pending	
HP	Universal Coated Paper	pending	pending	pending	
HP	Vellum	pending	pending	pending	

### General Calibrations

- **LED Gain Offset** and **Line Sensor to Black** relate to the Line Sensor and these are done when performing the Line Sensor Calibration.
- **Drop Detector** relates to the Drop Detector or Service Station calibration.
- **Paper Advance** relates to the Service Paper Advance Calibration.
- **Printhead Alignment** relates to the Printhead Alignment which changes to 'pending' when a Printhead is replaced and the Printhead Alignment has not been performed.

**When a component is replaced, the corresponding calibration is NOT automatically set to 'NOT DONE'. This is because the Printer does not know that there is a new part installed.**

### Media Specific Calibrations

This section shows the following for each type of media:

- **Color Calibration.**
- **Paper Advance** per media type and 'optimized for' Text/drawing and Graphics.



# System Error Codes

# 2

Introduction 2-2

Continuable and Non-Continuable Error Codes 2-2

System Error Codes and Warnings - Explanation 2-25

## System Error Codes

### Introduction

System error codes are hexa-decimal based numbers generally caused by internal system errors. The following pages contain a list of system error codes and their respective descriptions and recommended corrective actions. Only try one recommended action at a time and check if the error code has disappeared.

If you have an error code which is not documented in this Service Manual or you have an error which you cannot resolve, then report the error to the HP Response Center or the nearest HP Support Office. When reporting the error, have the following information ready:

- Model and Serial Number of the printer.
- Which firmware revision the printer is using (See Note below). Check firmware in *Setup Menu / Information Menu / Show Printer Information*.
- The complete error number (See Note below).
- The Service Configuration Print.
- The Current configuration sheet.
- Which software application the customer is using (name, version, etc.).

**When reporting the System Error Code, make sure that you supply the full Internal Error Code and the firmware version. Without this information, HP Support Personnel cannot help you. To view the Internal Error Code, hold the DOWN key and press the CANCEL key at the same time when the System Error Code is displayed on the Front Panel.**

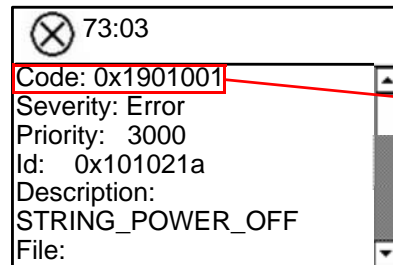

This is the Code that is required when escalating a problem

### Continuable and Non-Continuable Error Codes

Some of the Error Codes are continuable, which means you can press **Enter** on the front-panel and continue working with the Printer. Non-Continuable Error Codes do not allow you to continue working with the Printer, in this case power the Printer OFF and ON again and see if the System Error disappears. If the Error Code reappears, then the Printer requires an on-site visit in order to resolve the problem.

**Even though the customer can continue working with a Continuable Error Code, an on-site visit should still be planned to troubleshoot the problem.**



**System Error:** 01.0:03  
**Problem Description:** Error impact I2C channel.  
**Corrective Action:** Try the following:

- Switch the Power OFF from the back of the Printer and disconnect the Power cord. Reconnect the power cord and power On the Printer.
- If the System Error continues, replace the Gamut PCI PCA ⇒ Page 8-69.

**System Error:** 01.0:10  
**Problem Description:** Problem with the Gamut PCI PCA.  
**Corrective Action:** Try the following:

- Switch the Power OFF from the back of the Printer and disconnect the Power cord. Reconnect the power cord and power On the Printer.
- Replace the Gamut PCI PCA ⇒ Page 8-69.
- If the System Error continues, replace the Main PCA ⇒ Page 8-74.

**Only replace one component at a time and check if the error has gone before replacing another component. Using this procedure you will be able to determine exactly which component failed.**

**System Error:** 01.1:10  
**Problem Description:** Problem with the PrintMech PCA.  
**Corrective Action:** Try the following:

- Switch the Power OFF from the back of the Printer and disconnect the Power cord. Reconnect the power cord and power On the Printer.
- Check that the cables between the PrintMech PCA and the Gamut PCI PCA are not damaged and are correctly connected.
- Replace the PrintMech PCA ⇒ Page 8-84.
- If the System Error continues, replace the Gamut PCI PCA ⇒ Page 8-69.

**Only replace one component at a time and check if the error has gone before replacing another component. Using this procedure you will be able to determine exactly which component failed.**

**System Error:** 01.2:10  
**Problem Description:** ISS PCA faulty - Humidity sensor out of scale or NVM backup failure.  
**Corrective Action:** Try the following:

- Switch the Power OFF from the back of the Printer and disconnect the Power cord. Reconnect the power cord and power On the Printer.
- If the System Error continues, replace the Ink Supply Tubes and Trailing Cable ⇒ Page 8-33.

**System Error:** 02:10  
**Problem Description:** Encoder seems to be wrong.  
**Corrective Action:** Try the following:

- Check that the Carriage Stopper is correctly installed (Refer to Carriage Disassembly Instructions ⇒ Page 8-53, Step 16.).
- Replace the Carriage Assembly ⇒ Page 8-53.
- If the System Error continues, replace the Encoder Strip and Encoder Sensor ⇒ Page 8-45.

**Only replace one component at a time and check if the error has gone before replacing another component. Using this procedure you will be able to determine exactly which component failed.**

**System Error:** 02.1:10  
**Problem Description:** Problem with the Carriage PCA.  
**Corrective Action:** Try the following:

- Switch the Power OFF from the back of the Printer and disconnect the Power cord. Reconnect the power cord and power On the Printer.
- Check that the Trailing Cable is not damaged.
- Check that the Trailing Cable is correctly connected to the Carriage PCA, Interconnect PCA and to the Gamut PCI PCA.
- Replace the Carriage PCA ⇒ Page 8-48.
- If the System Error continues, replace the Gamut PCI PCA ⇒ Page 8-69.

**Only replace one component at a time and check if the error has gone before replacing another component. Using this procedure you will be able to determine exactly which component failed.**

<b>System Error:</b>	03:10
<b>Problem Description:</b>	Problem with the Power Supply Unit.
<b>Corrective Action:</b>	Try the following: <ul style="list-style-type: none"><li>■ Switch the Power OFF from the back of the Printer and disconnect the Power cord. Reconnect the power cord and power On the Printer.</li><li>■ Perform the Electronics Modules Test (⇒ Page 4-17) to troubleshoot the problem further.</li><li>■ If the System Error continues, replace the Power Supply Unit ⇒ Page 8-78.</li></ul>
<b>System Error:</b>	05.1:10
<b>Problem Description:</b>	CPU Fan is stopped or burnt.
<b>Corrective Action:</b>	Try the following: <ul style="list-style-type: none"><li>■ Switch the Power OFF from the back of the Printer and disconnect the Power cord. Reconnect the power cord and power On the Printer.</li><li>■ Replace the CPU Fan ⇒ Page 8-76.</li><li>■ If the System Error continues, replace the Main PCA ⇒ Page 8-74.</li></ul> <p><b>Only replace one component at a time and check if the error has gone before replacing another component. Using this procedure you will be able to determine exactly which component failed.</b></p>
<b>System Error:</b>	05.3:10
<b>Problem Description:</b>	Main memory size failure.
<b>Corrective Action:</b>	Try the following: <ul style="list-style-type: none"><li>■ Check that at least 256 megabytes of memory is installed in the Printer.</li><li>■ Check that the Memory Module is installed correctly.</li><li>■ Try installing the Memory Module in the other Memory slot and check if the System Error appears.</li><li>■ If the System Error reappears, replace the Memory Module ⇒ Page 8-72.</li><li>■ If the System Error does NOT reappear, then the original slot could be faulty. In this case, replace the Main PCA ⇒ Page 8-74.</li></ul>
<b>System Error:</b>	06:03
<b>Problem Description:</b>	NVM file has bad CRC.
<b>Corrective Action:</b>	Try the following: <ul style="list-style-type: none"><li>■ Switch the Power OFF from the back of the Printer and disconnect the Power cord. Reconnect the power cord and power On the Printer.</li><li>■ If the System Error continues, replace the Hard Disk Drive ⇒ Page 8-76.</li></ul>

**System Error:** 06:10  
**Problem Description:** Main NVM failure - not detected, read/write failed or readback error.  
**Corrective Action:** Try the following:

- Switch the Power OFF from the back of the Printer and disconnect the Power cord. Reconnect the power cord and power On the Printer.
- If the System Error continues, replace the Hard Disk Drive ⇒ Page 8-76.

**System Error:** 07:10  
**Problem Description:** Aerosol Fan driver burnt.  
**Corrective Action:** Try the following:

- Replace the Interconnect PCA ⇒ Page 8-64.
- If the System Error continues, replace the Gamut PCI PCA ⇒ Page 8-69.

**Only replace one component at a time and check if the error has gone before replacing another component. Using this procedure you will be able to determine exactly which component failed.**

**System Error:** 08:11  
**Problem Description:** Problem with the Front Panel.  
**Corrective Action:** Try the following:

- Switch the Power OFF from the back of the Printer and disconnect the Power cord. Reconnect the power cord and power On the Printer.
- Check that the Front Panel cable is not damaged and is correctly connected to the Front Panel and to the Interconnect PCA.
- Check that the Memory Module is installed correctly.
- Check that the cables between the Interconnect PCA and the Main PCA are not damaged and are correctly connected.
- Check that the cables between the Hard Disk Drive and the Power Supply Unit and the Main PCA are not damaged and are correctly connected.
- Check that the cable between the Power Supply Unit and the Main PCA is not damaged and is correctly connected.
- Check that the Printer has the latest Firmware version. If not, update the Firmware to the latest version.
- Replace the Main PCA ⇒ Page 8-74.
- Replace the Hard Disk Drive ⇒ Page 8-76.
- Replace the Memory Module ⇒ Page 8-72.
- Replace the Interconnect PCA ⇒ Page 8-64.
- If the System Error continues, replace the Front Panel ⇒ Page 8-20.

**System Error:** 11:10

**Problem Description:** Trailing Cable does not seem to be detected.

**Corrective Action:** Try the following:

- Check that the Trailing Cable is not damaged.
- Check that the Trailing Cable is correctly connected to the Carriage PCA, Interconnect PCA and to the Gamut PCI PCA.
- Replace the Gamut PCI PCA ⇒ Page 8-69.
- Replace the Ink Supply Tubes and Trailing Cable ⇒ Page 8-33.
- Replace the Carriage PCA ⇒ Page 8-48.

**Only replace one component at a time and check if the error has gone before replacing another component. Using this procedure you will be able to determine exactly which component failed.**

**System Error:** 13.n:10

**Problem Description:** Problem starting acumen supplies.

**Corrective Action:** Try the following:

- Remove ALL Ink Cartridges and reinstall them in the Printer.
- Check that the ISS to Cartridge cables are not damaged and are correctly connected to the Ink Supply Tubes PCA.
- Replace the ISS to Cartridge cables ⇒ Page 8-38
- Replace the Ink Supply Tubes and Trailing Cable ⇒ Page 8-33.

**System Error:** 21:03

**Problem Description:** Service Station servo shutdown.

**Corrective Action:** Try the following:

- Switch the Power OFF from the back of the Printer and disconnect the Power cord. Reconnect the power cord and power On the Printer.
- If the System Error continues, replace the Service Station ⇒ Page 8-23.
- Replace the PrintMech PCA ⇒ Page 8-84.
- Replace the Interconnect PCA ⇒ Page 8-64.

**Only replace one component at a time and check if the error has gone before replacing another component. Using this procedure you will be able to determine exactly which component failed.**

**System Error:** 21:12  
**Problem Description:** Fail moving Service Station.  
**Corrective Action:** Try the following:

- Switch the Power OFF from the back of the Printer and disconnect the Power cord. Reconnect the power cord and power On the Printer.
- If the System Error continues, replace the Service Station ⇒ Page 8-23.

**System Error:** 21:13  
**Problem Description:** Problem with the Service Station.  
**Corrective Action:** Try the following:

- Switch the Power OFF from the back of the Printer and disconnect the Power cord. Reconnect the power cord and power On the Printer.
- Make sure that the Service Station path is clear. Remove any visible obstacles (e.g. screws, plastic parts, etc...) restricting the movement of the Service Station.
- If the System Error continues, replace the Service Station ⇒ Page 8-23.

**System Error:** 23:10  
**Problem Description:** Problem with the APS.  
**Corrective Action:** Try the following:

- Switch the Power OFF from the back of the Printer and disconnect the Power cord. Reconnect the power cord and power On the Printer.
- Check that the APS cable is not damaged and is correctly connected to the PrintMech PCA.
- Replace the APS Assembly ⇒ Page 8-42.
- Replace the PrintMech PCA ⇒ Page 8-84.
- If the System Error continues, replace the Gamut PCI PCA ⇒ Page 8-69.

**Only replace one component at a time and check if the error has gone before replacing another component. Using this procedure you will be able to determine exactly which component failed.**

- System Error:** 24:03  
**Problem Description:** Ink Setup failure (Ink Supply Tubes purge failed).  
**Corrective Action:** Try the following:
- Switch the Power OFF from the back of the Printer and disconnect the Power cord. Reconnect the power cord and power On the Printer.
  - Try purging the Ink Supply Tubes again once the Printer has been rebooted.
  - Install new Ink Cartridges in to the Printer and try purging the Printer again.
- System Error:** 24:10  
**Problem Description:** Broken bag detected in Ink Cartridge.  
**Corrective Action:** Try the following:
- Remove the Ink Cartridges and check for ink leakage in the ISS area.
  - Perform the "Bag Broken Recovery" Diagnostic (⇒ Page 4-36) to further troubleshoot the error code.
- System Error:** 26.0:01  
**Problem Description:** Bad contact detected in ISS slot0 floater.  
**Corrective Action:** Try the following:
- Remove the Yellow Ink Cartridge and reinstall it in to the Printer.
  - Replace the Yellow Ink Cartridge.
  - Check that the ISS to Cartridge cable (Yellow Ink Cartridge) is not damaged and is correctly connected to the Ink Supply Tubes PCA.
  - Replace the ISS to Cartridge cable (Yellow Ink Cartridge) ⇒ Page 8-38.
  - Replace the Ink Supply Tubes and Trailing Cable ⇒ Page 8-33.
- System Error:** 26.1:01  
**Problem Description:** Bad contact detected in ISS slot1 floater.  
**Corrective Action:** Try the following:
- Remove the Magenta Ink Cartridge and reinstall it in to the Printer.
  - Replace the Magenta Ink Cartridge.
  - Check that the ISS to Cartridge cable (Magenta Ink Cartridge) is not damaged and is correctly connected to the Ink Supply Tubes PCA.
  - Replace the ISS to Cartridge cable (Magenta Ink Cartridge) ⇒ Page 8-38.
  - Replace the Ink Supply Tubes and Trailing Cable ⇒ Page 8-33.

- System Error:** 26.2:01  
**Problem Description:** Bad contact detected in ISS slot2 floater.  
**Corrective Action:** Try the following:
- Remove the Black Ink Cartridge and reinstall it in to the Printer.
  - Replace the Black Ink Cartridge.
  - Check that the ISS to Cartridge cable (Black Ink Cartridge) is not damaged and is correctly connected to the Ink Supply Tubes PCA.
  - Replace the ISS to Cartridge cable (Black Ink Cartridge) ⇒ Page 8-38.
  - Replace the Ink Supply Tubes and Trailing Cable ⇒ Page 8-33.
- System Error:** 26.3:01  
**Problem Description:** Bad contact detected in ISS slot3 floater.  
**Corrective Action:** Try the following:
- Remove the Cyan Ink Cartridge and reinstall it in to the Printer.
  - Replace the Cyan Ink Cartridge.
  - Check that the ISS to Cartridge cable (Cyan Ink Cartridge) is not damaged and is correctly connected to the Ink Supply Tubes PCA.
  - Replace the ISS to Cartridge cable (Cyan Ink Cartridge) ⇒ Page 8-38.
  - Replace the Ink Supply Tubes and Trailing Cable ⇒ Page 8-33.
- System Error:** 26.n:10  
**Problem Description:** Order of Ink Supplies incorrect.  
**Corrective Action:** Try the following:
- Remove the Ink Cartridges and check that they are the correct ones for this Printer and that they are inserted in the correct position.
  - Check that the Printer has the latest Firmware version. If not, update the Firmware to the latest version.
- System Error:** 26:14  
**Problem Description:** A wrong Ink Cartridge has been detected.  
**Corrective Action:** Try the following:
- Remove the Ink Cartridges and check that they are the correct ones for this Printer.
  - Check that the Printer has the latest Firmware version. If not, update the Firmware to the latest version.
  - Replace the Ink Cartridges.



- System Error:** 27:03  
**Problem Description:** An error has occurred in Printhead detection.  
**Corrective Action:** Try the following:
- Switch the Power OFF from the back of the Printer and disconnect the Power cord. Reconnect the power cord and power On the Printer.
  - Remove the Printheads from the Carriage and reinsert them.
  - Replace the Printheads.
  - Replace the Carriage Flex Cables ⇒ Page 8-51.
- System Error:** 27:14  
**Problem Description:** A wrong Printhead has been detected.  
**Corrective Action:** Try the following:
- Remove the Printheads and check that they are the correct ones for this Printer.
  - Check that the Printer has the latest Firmware version. If not, update the Firmware to the latest version.
  - Replace the Printheads.
- System Error:** 29.0:01  
**Problem Description:** Printhead Cleaner not inserted correctly in slot 1.  
**Corrective Action:** Try the following:
- Open the Printhead Cleaner Access Door and check that the Yellow Printhead Cleaner is correctly seated in slot 1 of the Service Station and then close the Printhead Cleaner Access Door.
  - Replace the Yellow Printhead Cleaner in slot 1 of the Service Station.
- System Error:** 29.1:01  
**Problem Description:** Printhead Cleaner not inserted correctly in slot 2.  
**Corrective Action:** Try the following:
- Open the Printhead Cleaner Access Door and check that the Yellow Printhead Cleaner is correctly seated in slot 2 of the Service Station and then close the Printhead Cleaner Access Door.
  - Replace the Yellow Printhead Cleaner in slot 2 of the Service Station.

- System Error:** 29.2:01  
**Problem Description:** Printhead Cleaner not inserted correctly in slot 3.  
**Corrective Action:** Try the following:
- Open the Printhead Cleaner Access Door and check that the Magenta Printhead Cleaner is correctly seated in slot 3 of the Service Station and then close the Printhead Cleaner Access Door.
  - Replace the Magenta Printhead Cleaner in slot 3 of the Service Station.
- System Error:** 29.3:01  
**Problem Description:** Printhead Cleaner not inserted correctly in slot 4.  
**Corrective Action:** Try the following:
- Open the Printhead Cleaner Access Door and check that the Magenta Printhead Cleaner is correctly seated in slot 4 of the Service Station and then close the Printhead Cleaner Access Door.
  - Replace the Magenta Printhead Cleaner in slot 4 of the Service Station.
- System Error:** 29.4:01  
**Problem Description:** Printhead Cleaner not inserted correctly in slot 5.  
**Corrective Action:** Try the following:
- Open the Printhead Cleaner Access Door and check that the Black Printhead Cleaner is correctly seated in slot 5 of the Service Station and then close the Printhead Cleaner Access Door.
  - Replace the Black Printhead Cleaner in slot 5 of the Service Station.
- System Error:** 29.5:01  
**Problem Description:** Printhead Cleaner not inserted correctly in slot 6.  
**Corrective Action:** Try the following:
- Open the Printhead Cleaner Access Door and check that the Black Printhead Cleaner is correctly seated in slot 6 of the Service Station and then close the Printhead Cleaner Access Door.
  - Replace the Black Printhead Cleaner in slot 6 of the Service Station.

- System Error:** 29.6:01  
**Problem Description:** Printhead Cleaner not inserted correctly in slot 7.  
**Corrective Action:** Try the following:
- Open the Printhead Cleaner Access Door and check that the Cyan Printhead Cleaner is correctly seated in slot 7 of the Service Station and then close the Printhead Cleaner Access Door.
  - Replace the Cyan Printhead Cleaner in slot 7 of the Service Station.
- System Error:** 29.7:01  
**Problem Description:** Printhead Cleaner not inserted correctly in slot 8.  
**Corrective Action:** Try the following:
- Open the Printhead Cleaner Access Door and check that the Cyan Printhead Cleaner is correctly seated in slot 8 of the Service Station and then close the Printhead Cleaner Access Door.
  - Replace the Cyan Printhead Cleaner in slot 8 of the Service Station.
- System Error:** 41:03  
**Problem Description:** Electrical current limit in Media-Axis Motor.  
**Corrective Action:** Try the following:
- Switch the Power OFF from the back of the Printer and disconnect the Power cord. Reconnect the power cord and power On the Printer.
  - Open the Window and check for any visible obstacles restricting the movement of the Drive Roller. If there is a wrinkled mass of media inside the paper path, lift the Pinchwheels (using the Media Lever) and clear the obstruction.
  - Replace the Media-Axis Motor ⇒ Page 8-62.
  - If the System Error continues, replace the PrintMech PCA ⇒ Page 8-84.
- System Error:** 41:10  
**Problem Description:** Electrical fault in Media-Axis Motor.  
**Corrective Action:** Try the following:
- Switch the Power OFF from the back of the Printer and disconnect the Power cord. Reconnect the power cord and power On the Printer.
  - Check that the Media-Axis Motor cable is not damaged and is correctly connected to the PrintMech PCA.
  - Replace the Media-Axis Motor ⇒ Page 8-62.
  - If the System Error continues, replace the PrintMech PCA ⇒ Page 8-84.

**System Error:** 42:03  
**Problem Description:** Electrical current limit in Scan-Axis Motor.  
**Corrective Action:** Try the following:

- Switch the Power OFF from the back of the Printer and disconnect the Power cord. Reconnect the power cord and power On the Printer.
- Open the Window and check for any visible obstacles restricting the movement of the Carriage Assembly. If there is a wrinkled mass of media blocking the Carriage Assembly, then clear the obstruction.
- Replace the Scan-Axis Motor ⇒ Page 8-59.
- If the System Error continues, replace the PrintMech PCA ⇒ Page 8-84.

**System Error:** 42:10  
**Problem Description:** Electrical fault in Scan-Axis Motor.  
**Corrective Action:** Try the following:

- Switch the Power OFF from the back of the Printer and disconnect the Power cord. Reconnect the power cord and power On the Printer.
- Check that the Scan-Axis Motor cable is not damaged and is correctly connected to the PrintMech PCA.
- Replace the Scan-Axis Motor ⇒ Page 8-59.
- If the System Error continues, replace the PrintMech PCA ⇒ Page 8-84.

**System Error:** 43:10  
**Problem Description:** Vacuum Fan has stopped functioning.  
**Corrective Action:** Try the following:

- Switch the Power OFF from the back of the Printer and disconnect the Power cord. Reconnect the power cord and power On the Printer.
- Check that the Vacuum Fan cables are not damaged and are correctly connected to the Interconnect PCA.
- Also check that the cables between the Interconnect PCA and the PrintMech PCA are not damaged and are correctly connected.
- Replace the Vacuum Fan ⇒ Page 8-27.
- If the System Error continues, replace the PrintMech PCA ⇒ Page 8-84.

- System Error:** 44:10  
**Problem Description:** Problem with the Aerosol Fan.  
**Corrective Action:** Try the following:
- Switch the Power OFF from the back of the Printer and disconnect the Power cord. Reconnect the power cord and power On the Printer.
  - Check that the Aerosol Fan cable is not damaged and is correctly connected to the Interconnect PCA.
  - Replace the Aerosol Fan ⇒ Page 8-29.
  - If the System Error continues, replace the Interconnect PCA ⇒ Page 8-64.
- System Error:** 44:11  
**Problem Description:** Aerosol Fan not connected.  
**Corrective Action:** Try the following:
- Check that the Aerosol Fan cable is not damaged and is correctly connected to the Interconnect PCA.
  - Replace the Aerosol Fan ⇒ Page 8-29.
- System Error:** 51:10  
**Problem Description:** Window Sensor failure.  
**Corrective Action:** Try the following:
- Check that the Window Sensor cable is not damaged and is correctly connected to the Interconnect PCA.
  - Replace the Window Sensor.
- System Error:** 51.1:10  
**Problem Description:** PHC Access Door Sensor failure.  
**Corrective Action:** Try the following:
- Check that the PHC Access Door Sensor cable is not damaged and is correctly connected to the Interconnect PCA.
  - Replace the PHC Access Door Sensor.

- System Error:** 52:10
- Problem Description:** Drop Detector switch On/Off failure.
- Corrective Action:** Try the following:
- Switch the Power OFF from the back of the Printer and disconnect the Power cord. Reconnect the power cord and power On the Printer.
  - Check that the Drop Detector cable is not damaged and is correctly connected to the Service Station cable.
  - Check that the Service Station cable is not damaged and is correctly connected to the Interconnect PCA.
  - Replace the Drop Detector ⇒ Page 8-37.
  - Replace the Gamut PCI PCA ⇒ Page 8-69.
  - If the System Error continues, replace the Interconnect PCA ⇒ Page 8-64.

**Only replace one component at a time and check if the error has gone before replacing another component. Using this procedure you will be able to determine exactly which component failed.**

- System Error:** 53:10
- Problem Description:** Media Sensor failure.
- Corrective Action:** Try the following:
- Check that the Media Sensor cable is not damaged and is connected correctly to the Interconnect PCA.
  - Replace the Media Sensor ⇒ Page 8-101.

- System Error:** 54:10
- Problem Description:** Media Lever Sensor failure.
- Corrective Action:** Try the following:
- Check that the Media Lever Sensor cable is not damaged and is connected correctly to the Interconnect PCA.
  - Replace the Media Lever Sensor ⇒ Page 8-108.

- System Error:** 55:10
- Problem Description:** Problem with the Line Sensor.
- Corrective Action:** Try the following:
- Switch the Power OFF from the back of the Printer and disconnect the Power cord. Reconnect the power cord and power On the Printer.
  - Replace the Line Sensor ⇒ Page 8-37.
  - If the System Error continues, replace the Carriage PCA ⇒ Page 8-48.

- System Error:** 56:03  
**Problem Description:** Analog Encoder calibration failed.  
**Corrective Action:** Try the following:
- Switch the Power OFF from the back of the Printer and disconnect the Power cord. Reconnect the power cord and power On the Printer.
  - Replace the Encoder Disc and Sensor ⇒ Page 8-103.
  - If the System Error continues, replace the PrintMech PCA ⇒ Page 8-84.
- System Error:** 56:10  
**Problem Description:** Analog Encoder calibration failed.  
**Corrective Action:** Try the following:
- Replace the Encoder Disc and Sensor ⇒ Page 8-103.
- System Error:** 61:01  
**Problem Description:** The file format is incorrect and the Printer cannot process the job.  
**Corrective Action:** Try the following:
- Switch the Power OFF from the back of the Printer and disconnect the Power cord. Reconnect the power cord and power On the Printer.
  - Check the graphic language setting of the Printer (Refer to the User's Guide).
  - Resend the file to the Printer.
  - Check that the Printer has the latest Firmware version. If not, update the Firmware to the latest version.
- System Error:** 61:04.1  
**Problem Description:** The Postscript fonts are missing. Upgrading the Firmware will re-install the fonts.  
**Corrective Action:** Perform a full firmware upgrade that includes package 'B'.

<b>System Error:</b>	61:08.1
<b>Problem Description:</b>	The file cannot be printed because it is password protected.
<b>Corrective Action:</b>	Resend the file without password protection.
<b>System Error:</b>	63:04
<b>Problem Description:</b>	Input/Output problem through the Network Card.
<b>Corrective Action:</b>	Try the following: <ul style="list-style-type: none"><li>■ Check that the Network cable is correctly connected to the Network Card.</li><li>■ If a Gigabit Ethernet Card is being used, make sure it is correctly installed. If necessary, replace the Gigabit Ethernet Card.</li><li>■ Check that the Printer has the latest Firmware version. If not, update the Firmware to the latest version.</li><li>■ If the System Error continues, replace the Main PCA ⇒ Page 8-74.</li></ul>
<b>System Error:</b>	64:04
<b>Problem Description:</b>	Input/Output problem through the USB Port.
<b>Corrective Action:</b>	Try the following: <ul style="list-style-type: none"><li>■ Check that the USB cable is correctly connected to the Printer.</li><li>■ Check that the USB Card is correctly installed.</li><li>■ Check that the Printer has the latest Firmware version. If not, update the Firmware to the latest version.</li><li>■ Replace the USB card.</li></ul>
<b>System Error:</b>	65:04
<b>Problem Description:</b>	Input/Output problem through an unknown port.
<b>Corrective Action:</b>	Try the following: <ul style="list-style-type: none"><li>■ Check that the unknown port cable is correctly connected to the Printer.</li><li>■ Check that the Printer has the latest Firmware version. If not, update the Firmware to the latest version.</li></ul>
<b>System Error:</b>	66:08
<b>Problem Description:</b>	Cannot print file on current paper type. The paper type has changed since the file was sent, so the file cannot be printed on the paper type currently loaded.
<b>Corrective Action:</b>	Try the following: <ul style="list-style-type: none"><li>■ Resend the file to be printed on the current paper type.</li><li>■ Change the paper type to the type that was loaded when the file was originally sent.</li></ul>



<b>System Error:</b>	67:04
<b>Problem Description:</b>	Input/Output problem through an Firewire Port.
<b>Corrective Action:</b>	Try the following: <ul style="list-style-type: none"><li>■ Check that the Firewire cable is correctly connected to the Printer.</li><li>■ Check that the Printer has the latest Firmware version. If not, update the Firmware to the latest version.</li><li>■ If the System Error continues, replace the Main PCA ⇒ Page 8-74.</li></ul>
<b>System Error:</b>	68:03
<b>Problem Description:</b>	Non-critical permanent data was lost. This does not prevent the Printer to work, only that internal life counters will not be recorded until the Printer is restarted.
<b>Corrective Action:</b>	Try the following: <ul style="list-style-type: none"><li>■ Switch the Power OFF from the back of the Printer and disconnect the Power cord. Reconnect the power cord and power On the Printer.</li><li>■ Check that the Printer has the latest Firmware version. If not, update the Firmware to the latest version.</li></ul>
<b>System Error:</b>	71:03
<b>Problem Description:</b>	Out of memory failure.
<b>Corrective Action:</b>	It is recommended that you remove any unnecessary files from the Hard Disk Drive using the Web Server.
<b>System Error:</b>	71:04
<b>Problem Description:</b>	Out of memory failure.
<b>Corrective Action:</b>	It is recommended that you remove any unnecessary files from the Hard Disk Drive using the Web Server.
<b>System Error:</b>	71:19
<b>Problem Description:</b>	Default Serial Number found in the main and backup NVM. It seems that both the Ink Supply Tubes and Hard Disk Drive have been replaced together.
<b>Corrective Action:</b>	Try the following: <ul style="list-style-type: none"><li>■ Perform the "Error 71:19 Recovery" Service Utility (refer to Chapter 4).</li></ul>

**You MUST NEVER replace both the Hard Disk Drive and the Ink Supply Tubes and Trailing Cable at the same time. If both parts need to be replaced, you MUST first replace one part and then power ON the Printer until it completely initializes. Then you can power OFF the Printer and replace the other part.**

**System Error:** 72:04  
**Problem Description:** Generic Firmware error.  
**Corrective Action:** Try the following:

- Switch the Power OFF from the back of the Printer and disconnect the Power cord. Reconnect the power cord and power On the Printer.
- Check that the Printer has the latest Firmware version. If not, update the Firmware to the latest version.

**System Error:** 73:03  
**Problem Description:** Servo Error.  
**Corrective Action:** Try the following:

- Switch the Power OFF from the back of the Printer and disconnect the Power cord. Reconnect the power cord and power On the Printer.
- Check that the Printer has the latest Firmware version. If not, update the Firmware to the latest version.
- Perform the "Scan-Axis" Diagnostic (⇒ Page 4-7) to further troubleshoot the error code.
- If the System Error continues, perform the "Media Drive" Diagnostic (⇒ Page 4-12) to further troubleshoot the error code.

**System Error:** 74:00  
**Problem Description:** Failed getting Part Number/Serial Number.  
**Corrective Action:** Try the following:

- Switch the Power OFF from the back of the Printer and disconnect the Power cord. Reconnect the power cord and power On the Printer.
- Check that the Printer has the latest Firmware version. If not, update the Firmware to the latest version.

**System Error:** 74:01  
**Problem Description:** Error uploading firmware update file.  
**Corrective Action:** Try the following:

- Switch the Power OFF from the back of the Printer and disconnect the Power cord. Reconnect the power cord and power On the Printer.
- Resend the firmware update file to the Printer.

- System Error:** 74:04  
**Problem Description:** Old Vacuum Fan detected - upgrade the Firmware.  
**Corrective Action:** Try the following:
- Check that the Printer has the latest Firmware version. If not, update the Firmware to the latest version.
- System Error:** 76:03  
**Problem Description:** Out of Disk space - Data was lost.  
**Corrective Action:** Try the following:
- Switch the Power OFF from the back of the Printer and disconnect the Power cord. Reconnect the power cord and power On the Printer.
  - Resend the file to the Printer.
  - If the System Error continues, it is recommended that you remove any unnecessary files from the Hard Disk Drive using the Web Server.
  - Perform an EEROM Reset (⇒ Page 4-43) and resend the file to the Printer.
- System Error:** 77:04  
**Problem Description:** Embedded Web Server internal software error.  
**Corrective Action:** Try the following:
- Switch the Power OFF from the back of the Printer and disconnect the Power cord. Reconnect the power cord and power On the Printer.
  - Check that the Printer has the latest Firmware version. If not, update the Firmware to the latest version.
- System Error:** 79:03  
**Problem Description:** Generic Firmware error.  
**Corrective Action:** Try the following:
- Switch the Power OFF from the back of the Printer and disconnect the Power cord. Reconnect the power cord and power On the Printer.
  - Check that the Printer has the latest Firmware version. If not, update the Firmware to the latest version.

<b>System Error:</b>	79:04
<b>Problem Description:</b>	Generic Firmware error.
<b>Corrective Action:</b>	Try the following: <ul style="list-style-type: none"><li>■ Switch the Power OFF from the back of the Printer and disconnect the Power cord. Reconnect the power cord and power On the Printer.</li><li>■ Check that the Printer has the latest Firmware version. If not, update the Firmware to the latest version.</li></ul>
<b>System Error:</b>	79.1:04
<b>Problem Description:</b>	CDS server lost connection with client.
<b>Corrective Action:</b>	Try the following: <ul style="list-style-type: none"><li>■ Switch the Power OFF from the back of the Printer and disconnect the Power cord. Reconnect the power cord and power On the Printer.</li><li>■ Check that the Printer has the latest Firmware version. If not, update the Firmware to the latest version.</li></ul>
<b>System Error:</b>	81:01
<b>Problem Description:</b>	Paper servo shutdown.
<b>Corrective Action:</b>	Try the following: <ul style="list-style-type: none"><li>■ Open the Window and check for any visible obstacles restricting the movement of the Drive Roller. If there is a wrinkled mass of media inside the paper path, lift the Pinchwheels (using the Media Lever) and clear the obstruction.</li><li>■ Perform the "Media Drive" Diagnostic (⇒ Page 4-12) to further troubleshoot the error code.</li><li>■ If the System Error continues, replace the Media-Axis Motor ⇒ Page 8-62.</li></ul>
<b>System Error:</b>	81:03
<b>Problem Description:</b>	It was impossible to correctly stop the servo before setting the encoder position.
<b>Corrective Action:</b>	Try the following: <ul style="list-style-type: none"><li>■ Open the Window and check for any visible obstacles restricting the movement of the Drive Roller. If there is a wrinkled mass of media inside the paper path, lift the Pinchwheels (using the Media Lever) and clear the obstruction.</li><li>■ Perform the "Media Drive" Diagnostic (⇒ Page 4-12) to further troubleshoot the error code.</li><li>■ If the System Error continues, replace the Media-Axis Motor ⇒ Page 8-62.</li></ul>

- System Error:** 81:10  
**Problem Description:** Fail starting Paper Motor.  
**Corrective Action:** Try the following:
- Open the Window and check for any visible obstacles restricting the movement of the Drive Roller. If there is a wrinkled mass of media inside the paper path, lift the Pinchwheels (using the Media Lever) and clear the obstruction.
  - Perform the "Media Drive" Diagnostic (⇒ Page 4-12) to further troubleshoot the error code.
  - If the System Error continues, replace the Media-Axis Motor ⇒ Page 8-62.
- System Error:** 85:03  
**Problem Description:** Problem finding the Drive Roller zero.  
**Corrective Action:** Try the following:
- Perform the "Media Drive" Diagnostic (⇒ Page 4-12) to further troubleshoot the error code.
- System Error:** 86:01  
**Problem Description:** Carriage servo shutdown.  
**Corrective Action:** Try the following:
- Open the Window and check for any visible obstacles restricting the movement of the Carriage Assembly. If there is a wrinkled mass of media inside the paper path, lift the Pinchwheels (using the Media Lever) and clear the obstruction.
  - Check that the Carriage Stopper is correctly installed (Refer to Carriage Disassembly Instructions ⇒ Page 8-53, Step 16.).
  - Perform the "Scan-Axis" Diagnostic (⇒ Page 4-7) to further troubleshoot the error code.
  - If the System Error continues, replace the Scan-Axis Motor ⇒ Page 8-59.
- System Error:** 86:03  
**Problem Description:** Scan-Axis length test failure.  
**Corrective Action:** Try the following:
- Perform the "Scan-Axis" Diagnostic (⇒ Page 4-7) to further troubleshoot the error code.

**System Error:** 86:10  
**Problem Description:** Initializing Scan-Axis Motor failure.  
**Corrective Action:** Try the following:

- Switch the Power OFF from the back of the Printer and disconnect the Power cord. Reconnect the power cord and power On the Printer.
- Check that the Carriage Belt is correctly installed.
- Replace the Encoder Strip and Encoder Sensor ⇒ Page 8-45.
- If the System Error continues, replace the Scan-Axis Motor ⇒ Page 8-59.

**System Error:** 86:11  
**Problem Description:** Scan-Axis length too short.  
**Corrective Action:** Try the following:

- Open the Window and check for any visible obstacles restricting the movement of the Carriage Assembly. If there is a wrinkled mass of media inside the paper path, lift the Pinchwheels (using the Media Lever) and clear the obstruction.
- Replace the Encoder Strip and Encoder Sensor ⇒ Page 8-45.

**System Error:** 91:02  
**Problem Description:** The HP Instant Support troubleshooting tool has detected that at least one Printhead has been replaced without having a specific error, and without being recovered/cleaned.  
**Corrective Action:** Advise the customer that the next time they want to replace a Printhead they should make sure that at least a Printhead Recovery is performed.

**System Error:** 91:10  
**Problem Description:** The HP Instant Support troubleshooting tool has detected that at least, for one Printhead:

- It is currently in warranty (less than 1000cc of ink used).
- That the previous 2 Printheads had been found defective within the warranty period.

**Corrective Action:** In this case, it is possible that the Printer is damaging the Printhead. If, after replacing the Printhead a third time, it is found to be defective again, you may need to troubleshoot the Carriage Flex Cables or the Carriage PCA.

**System Error:** 93:11  
**Problem Description:** Unable to pressurize the IDS.  
**Corrective Action:** Try the following:

- Remove ALL the Ink Cartridges and reinstall them one by one in to the Printer.
- Replace the Ink Cartridges.
- Replace the APS Assembly ⇒ Page 8-42.
- If the System Error continues, replace the Ink Supply Tubes and Trailing Cable ⇒ Page 8-33.

**System Error:** 98:02 (this error code will be logged in the system but will not actually appear on the Front Panel)  
**Problem Description:** Switching to lower performance due to Printhead quality.  
**Corrective Action:** Try the following:

- Try a Printhead recovery on the Printheads.
- Replace the faulty Printhead. You may have to print the Image Quality Diagnostics print in order to identify the faulty Printhead.

## System Error Codes and Warnings - Explanation

System Error Codes explain which component/system is failing and what action should be taken to resolve the problem.

**System Error Codes** are displayed directly on the front panel (but can also be seen on the Information Page) and have been defined in the format **XX.YZ**, or **XX.n:YZ.m**.

- **XX**: Service Part (2 digits).
- **n**: Service Part Index (if more than one used in the product) - Optional.  
– e.g. Identify the Ink Supply (color and number).
- **Y**: Who should perform the action (1 digit) - (User or Service Engineer).
- **Z**: Action to perform (1 digit).
- **m**: additional actions/information to consider (1 digit) - Optional.  
– e.g. Non-authorized ink was detected, PM was triggered or Printhead in/out of Warranty.

The following table explains the **XX** part of the System Error Code or Warning:

Items in **red** are not applicable to this printer.

Code	Component/System
01.0	Main PCA/Electronics Module (Gamut)
01.1	Add-on Electronics Module (Printmech)
01.2	ISS Electronics Module
02	Carriage
02.1	Carriage PCA
03	Power Supply Unit
04	Network Card
05	Formatter
05.1	Fan of the Formatter
05.2	Processor of the Formatter
05.3	Memory of the Formatter
06	Hard Disk Drive
07	Interconnect PCA
08	Front Panel
11	Trailing Cable
12	Carriage Flex Circuit
13.n	Cable from cartridge <b>n</b> to ISS PCA
17	Interconnect Cable
21	Service Station
22	Ink Supply Station
23	Pressure System (APS)
24	Ink Delivery Tubes
25	Spittoon
26n	Ink Cartridge (color <b>n</b> )
27n	Printhead (color <b>n</b> )
28n	Setup Printhead (color <b>n</b> )
29n	Printhead Cleaner (color <b>n</b> )
31	Cutter
32	Take-up Reel
33	Sheet Feeder
34	Dryer/Blower
35	Cleanout Assembly
36	Duplexer
37	ARSS/Rollfeed
38	Output Tray
39	Paper Loading Failure
41	Paper-Axis Motor
42	Scan-Axis Motor
43	Vacuum Fan
44	Aerosol Fan



Code	Component/System
45	Back Tension Motor
51	Window/Door Sensor
51.1	Service Station Door Sensor
52	Drop Detector
53	Media Sensor
54	Pinch-Arm Sensor
55	Line Sensor
56	Drive Roller Encoder Sensor
57	Ink Leak Detector
58	Color Sensor
59	Media Type Sensor
61	Language Interpreting
61.1	PS Fonts Missing
61.2	File with Passwords cannot be Printed
62	Input/Output through Parallel Port
63	Input/Output through LAN Card
63.0	Input/Output through Integrated LAN Card
63.1	Input/Output through add-on JetDirect LAN Card
63.2	Input/Output through add-on Gigabit LAN Card
64	Input/Output through USB Port
65	Input/Output (not know what port)
66	Print Job Configuration
67	Input/Output through FireWire Port
68	Loss of Engine Counters Tracking
71	Memory Management
72	Generic Firmware
73	Motor Control Functions
74	Firmware Upgrade
75	Preventive Maintenance
75.1	Preventive Maintenance Kit #1
75.2	Preventive Maintenance Kit #2
76	Disk Full
77	WebAccess Application
79	Assertion (Uncontrollable Firmware Error)
79.1	Warning (Uncontrollable Recoverable Firmware Error)
81	Media Advance
81	Media Cut
83	Single-Sheet Feeding
84	Roll Feeding
85	Media-Axis Encoder Reading
86	Carriage Movement
87	Scan-Axis Encoder Reading

Code	Component/System
91	Printhead Firing
92	Servicing
93	Ink Pumping
94	Color Calibration
95	Printhead Alignment
96	Image Quality Troubleshooting
97	Paper Advance Calibration
98	Automatic Backup Printmode Enabled

The following table explains the **YZ** part of the System Error Code or Warning:

Code	Recovery Action	Response
00	Replace	Possible for customer to perform action
01	Reseat/Reconnect/Clean/Adjust (manually)	
02	Calibrate/Adjust (using Automatic Process)	
03	Power OFF and Restart the Printer	
04	Upgrade System Firmware	
05	Upgrade Driver or Computer Software	
06	Add Accessory	
07	Escalate	
08	Send Plot Again	
09	Wrong Part Installed	hp qualified personnel assistance required
10	Replace	
11	Reseat/Reconnect/Clean/Adjust (manually)	
12	Calibrate/Adjust (using Automatic Process)	
13	Power OFF	
14	Upgrade System Firmware	
15	Upgrade Driver or Computer Software	
16	Add Accessory	
17	Escalate	
18	Send Plot Again	
19	Wrong Part Installed	



# Ink Supplies Troubleshooting

# 3

What are Ink Supplies?	3-2
Ink Cartridges	3-2
Printheads	3-3
Printhead Cleaners	3-3
General Information About the Ink Supplies	3-4
General Precautions When Handling Ink Supplies	3-4
Priming the Ink System	3-5
When Should You Replace the Ink Supplies?	3-5
Obtaining Ink Cartridge Information	3-6
Obtaining Printhead Information	3-7
Ink Cartridge Status Messages	3-9
Ink Cartridge Status While Printing	3-9
Ink Cartridge Status While Replacing	3-9
Printhead Status Messages While Printing	3-10
Printhead Status Messages While Replacing	3-10
Printhead Cleaner Status Messages While Printing	3-11
Printhead Cleaner Status Messages While Replacing	3-11
Summary of Solving Ink Supplies Problems	3-12
Troubleshooting Printhead Error Codes	3-13
Carriage Interconnect Wiper	3-14
Warranty Information for Ink Supplies	3-15
Warranty Information for Printheads	3-15

## What are Ink Supplies?

For each of the four ink colors used in the printer, there are three separate components. The Printhead and the Printhead Cleaner are supplied together, and the Ink Cartridge is supplied separately. All of these components are called Ink Supplies.

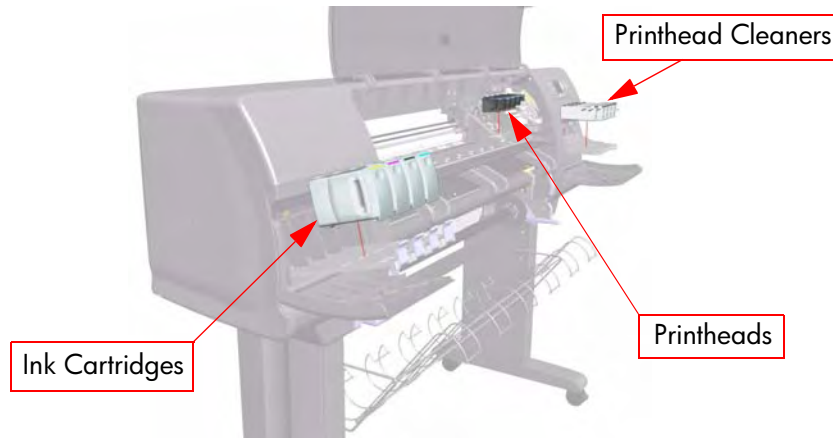

## Ink Cartridges

The printer's four Ink Cartridges provide yellow, magenta, black, and cyan ink to the Printheads. The color Ink Cartridges supplied with the printer have a capacity of 225 cm<sup>3</sup>, and the black cartridge has a capacity of 400 cm<sup>3</sup>. It is also possible to buy and use color cartridges with a capacity of 400 cm<sup>3</sup>.

**All these Ink cartridges are physically the same size, only the internal capacity varies.**



The Ink Cartridges for the hp designjet 4000 series printers require no maintenance or cleaning. As long as each Ink Cartridge is inserted correctly into its slot, the ink will flow to the Printheads. Because the Printheads control the amount of ink transferred to the page, you will continue to see high-quality printing results even when the ink levels are getting low.

The front panel displays the status of the Ink Cartridge. Using the front panel, detailed information can be checked on the Ink Cartridges.

## Printheads

In order to increase printing speed, two Printheads are connected to each Ink Cartridge, giving eight printheads in total.

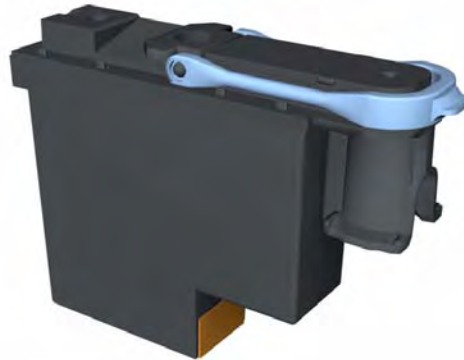

The Printheads are extremely durable and do not need to be replaced every time an Ink Cartridge is replaced. They are independent of the Ink Cartridges and will continue giving excellent image quality results even if the Ink Cartridges are low on ink.

If you notice a decline in print quality such as lines or dots missing from text/graphics, go to Page 6-13, *Troubleshooting Print Quality Problems*.

**Whenever a new Printhead is bought, it will come with a new Printhead Cleaner. When a Printhead is replaced, the Printhead Cleaner should be replaced at the same time. Leaving the old Printhead Cleaner in the Printer will shorten the new Printhead's life and possibly damage the Printer.**

## Printhead Cleaners

Each printhead has its own printhead cleaner, so there are eight printhead cleaners in the printer. Printhead cleaners are used to clean and maintain the printheads, to ensure the best possible print quality, and to seal the printheads when they are not in use to prevent them from drying out.

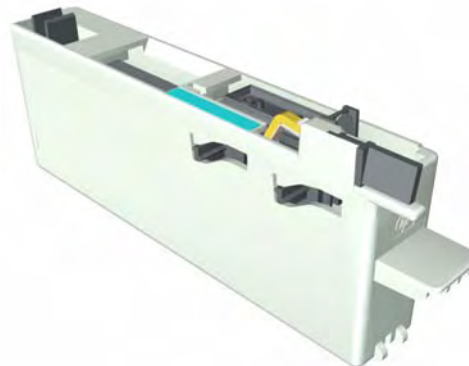

## General Information About the Ink Supplies

**For optimum results from the printer and modular ink delivery system always follow these guidelines when handling the ink supplies:**

- Always install the Ink Cartridges, Printheads and Printhead Cleaners before the expiration date, which is on the packaging.
- Install a new Printhead Cleaner every time you change a Printhead.
- Allow the Printer and Printhead Cleaners to automatically clean the Printheads.
- Install Ink Cartridges, Printheads and Printhead Cleaners in their color-coded slots.
- Follow the instructions on the front panel of the Printer during installation.
- Avoid unnecessary removal of the Ink Cartridges and Printheads.
- When turning off the Printer always use the power Off button on the front panel. The Printheads are then stored correctly which prevents them from drying out.
- The Ink Cartridges should never be removed while the printer is printing. They should only be removed when the printer is ready for you to replace them. The front panel will guide you through the removal and installation procedure.

## General Precautions When Handling Ink Supplies



**Do not touch, wipe or attempt to clean the printhead nozzles. This can damage the printhead.**

- Handle the ink supplies with care. In particular the Printhead, which is a high precision device and must be handled carefully.
- Do not touch the Printhead nozzles.
- Do not put the Printhead down on the nozzles.
- Do not be rough when handling the Printheads. Always set them down gently.
- Do not drop the Printheads.
- Proper handling will assure optimum performance throughout the Printhead life.
- The Printhead Cleaner should always be handled and stored upright to avoid a potential spillage of ink.
- Do not touch the end of the Ink Cartridge which is inserted into the printer as there may be a small amount of ink on the connection.
- Avoid storing partially used Ink Cartridges on their ends.

## Priming the Ink System

When the customer first receives the printer, it is supplied with a set of four Setup Printheads pre-installed in the Carriage Assembly. These Setup Printheads are used for the priming of the tubes in the modular ink delivery system. The customer must not remove the Setup Printheads from the Carriage without following the procedures in the *Setup Guide*.

When the Printer is powered ON for the first time, the Printer will automatically perform the priming process. Without the priming process, the customer will NOT be able to use the Printer.

Why does the Printer require priming:

- The Tubes System is empty when the customer receives the Printer.
- The Tubes System has to be pressurized and filled with ink, ejecting any air bubbles.



**If the Printing Printheads are installed in the carriage during the priming process, they will be rejected and the front panel will show a warning message.**

## When Should You Replace the Ink Supplies?

When to change the ink supplies is mostly determined by you with guidance from the front panel. In conjunction with the messages displayed in the front panel and the message explanations in this chapter, you will be able to choose for yourself when is the right time to change the ink supplies.

The Printer will also display the ink level and will tell you when the ink supply is low on ink. This means you have constantly updated information about the ink supplies.

Printhead life is anticipated to be 1000ml or twelve months in the printer, whichever occurs first, provided that the printhead is used under normal operating conditions (using HP Ink Cartridges only) and its "install before date" has not lapsed. However results vary depending on the print quality setting being used.

## Obtaining Ink Cartridge Information

- 1 Scroll to the Ink Menu icon and press **Enter**.

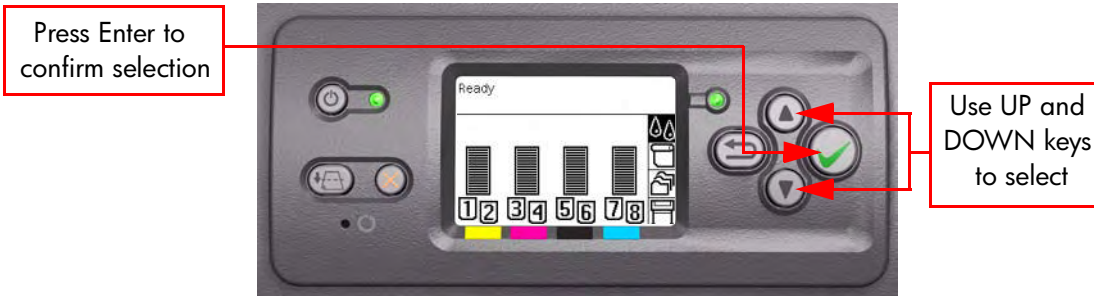

- 2 In the Ink Menu submenu, scroll to "Ink cartridges" and press **Enter**.



- 3 In the Ink Cartridges submenu, scroll to "Ink cartridge information" and press **Enter**.



- 4 In the Ink Cartridge Information submenu, scroll to the Ink Cartridge that you want information on and press **Enter**.





- 5 The front panel displays information on the selected Ink Cartridge.

```
Yellow ink cartridge
Product name: HP No 90
Product number: C5065A
Serial number: 1116688-29-8
Status: OK
Ink level: 379 ml
Capacity: 400 ml
Manufacturer: HP
Warranty status: In warranty
```

The information supplied is:

- The make of the Ink Cartridge (hp no.90 is recommended).
- The product number of the Ink Cartridge.
- The serial number of the Ink Cartridge.
- The current status of the Ink Cartridge.
- The current ink level of the ink cartridge in milliliters.
- Original capacity of the ink cartridge in milliliters.
- The manufacturer of the Ink Cartridge (hp is recommended).
- The current warranty status of the Ink Cartridge.

## Obtaining Printhead Information

- 1 Scroll to the Ink Menu icon and press **Enter**.

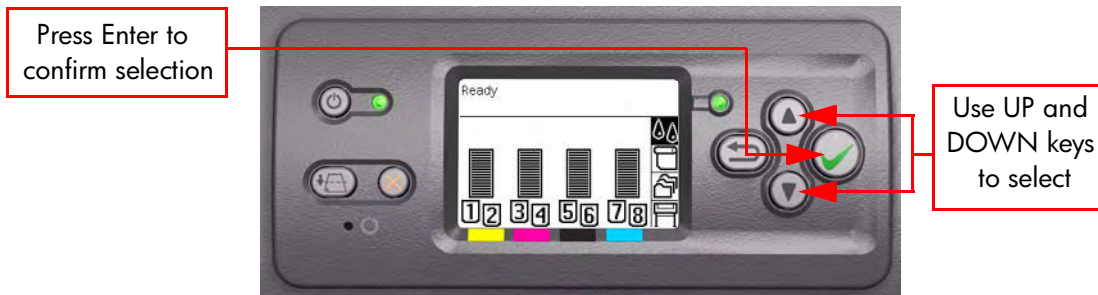

- 2 In the Ink Menu submenu, scroll to "Printheads" and press **Enter**.



- In the Printheads submenu, scroll to "Printhead information" and press **Enter**.



- In the Printhead Information submenu, scroll to the Printhead that you want information on and press **Enter**.



- The front panel displays information on the selected printhead.

```

Yellow printhead 1
Product name: HP No 90
Product number: C5057A
Serial number: 16455695-33-8
Printhead status: OK
Ink fired: 3 ml
Warranty status: In warranty
Cleaner status: OK
    
```

The information supplied is:

- The make of the printhead (hp no.90 is recommended).
- The product number of the Printhead.
- The serial number of the Printhead.
- The current status of the printhead.
- How much ink has been fired (consumed) by the printhead. **Note:** It is possible for a printhead to consume more than one Ink Cartridge.
- The current warranty status of the Printhead.
- The current status of the Printhead Cleaner.

## Ink Cartridge Status Messages

### Status Bars

The front panel displays four horizontal bars. These bars represent how much ink is remaining in the Ink Cartridges: as ink is used up the bars get shorter in length. To see how much ink is remaining, go to the "Ink Cartridge Information" submenu. See Page 3-6, *Obtaining Ink Cartridge Information*

## Ink Cartridge Status While Printing

### OK

The Ink Cartridge is operating correctly and no action is required.

### Low

The **Low** message is an early warning sign and it is advisable that new supplies should be obtained of that particular color. The amount of ink remaining in the Ink Cartridge depends on its capacity, but there is approximately 14% of ink available for the user.

### Very Low

When the **Very Low** message is displayed, overnight printing should not be attempted. Changing the Ink Cartridge is strongly recommended to prevent the printer from stopping halfway through a print. There is approximately 8% of ink available for the user.

### Empty

The printer will stop and will not be able to continue printing until a new Ink Cartridge has been installed. If this occurs halfway through printing an image, you should check the quality of this image, as stopping mid-plot can affect the print. It would be recommended to reprint the image once a new Ink Cartridge has been installed.

## Ink Cartridge Status While Replacing

The printer can report the following status messages while the Ink Cartridge is being replaced:

### Missing

The Ink Cartridge has not been installed or is installed incorrectly. The Printer will not print until ALL Ink Cartridges have been installed correctly.

### Reseat

The Ink Cartridge is having continuity problems. Try removing the Ink Cartridge from the Printer and inserting it in again.

### Replace

The Ink Cartridge is faulty and needs to be replaced before the printer can continue printing.

### Unknown

The Ink Cartridge installed is not approved **but** the user has confirmed that he is using refilled or non-hp Ink Cartridges. Refer to the User's Guide for further information regarding using refilled or non-hp approved Ink Cartridges.

### The main actions for all 4 status messages is as follows:

- 1 Reseat the Ink Cartridge.
- 2 If reseating does not resolve the status message, replace the Ink Cartridge.
- 3 If the Status messages continue to appear, even after replacing the Ink Cartridge, replace the Ink Supply Tubes and Trailing Cable ⇒ Page 8-33.

## Printhead Status Messages While Printing

Detailed below are the printhead status messages that may be displayed while printing.

### OK

The printhead is operating correctly and will provide an acceptable level of print quality. To find more information on the printheads, refer to Page 3-7, *Obtaining Printhead Information*.

### Replace

The Printhead is faulty and needs to be replaced before the printer can continue printing.

If this message continues to appear (for example after installing new Printheads), try the following:

- 1 Reseat the Printheads and check if the message disappears.
- 2 Remove the Drop Detector and make sure that there are no obstacles inside which are blocking the sensor.
- 3 Print the Diagnostic Print ⇒ Page 6-6. Check that the Printhead nozzles are firing correctly.
- 4 Perform the Service Station Calibration ⇒ Page 5-8.
- 5 Replace ALL the Printheads.

## Printhead Status Messages While Replacing

The following are the Printhead status messages that may be displayed while replacing the Printheads.

### Reseat

In this situation, select the Printhead replacement option through the Front Panel but do NOT remove the Printheads. If this status message continues to appear then remove the Printheads and install them again.

### Remove

The Printhead is not a suitable type for use in printing (for example, a Setup Printhead).

### Missing

No Printhead has been detected in that Carriage stall. If a Printhead is installed in the Carriage stall when this status message is shown:

- 1 Reseat the Printhead, making sure it is installed correctly.
- 2 Clean the Carriage and Printhead flex circuits using the Carriage Interconnect Wiper ⇒ Page 3-14.
- 3 Replace the Printhead.
- 4 Perform the Electronic Systems Test ⇒ Page 4-17.

**If all 8 Printheads are installed but have the Status message "Missing", it is possible that the Carriage Assembly is faulty.**

## Printhead Cleaner Status Messages While Printing

Detailed below are the Printhead Cleaner status messages that may be displayed while printing.

- OK** The Printhead Cleaner is operating correctly and no action is required.
- End of Life** The Printhead Cleaner has reached the end of its life and should be replaced.

## Printhead Cleaner Status Messages While Replacing

The following are the Printhead Cleaner status messages that may be displayed while replacing the Printheads.

- Reseat Cleaner** In this situation, remove the Printhead Cleaner and install it again.
- Wrong Stall** The Printhead Cleaner has been installed in the incorrect place. Remove the Printhead Cleaner and check that it is installed in the correct stall of the Service Station.
- Missing** The Printhead Cleaner has not been installed or is installed incorrectly. The Printer will not print until ALL Printhead Cleaners have been installed correctly.
- Not replaced with Printhead** A new Printhead has been installed without installing a new Printhead Cleaner that came with it. Make sure a new Printhead Cleaner is installed everytime you replace a Printhead.

If a Printhead Cleaner needs to be removed or reseated, you must first start the Printhead Replacement process. Open the window when prompted to do so by the front panel. If the front panel shows the Printheads with **no** Printhead blinking, you do not need to touch the Printheads. Just close the window again, and the Printer will proceed to Printhead Cleaner replacement.

## Summary of Solving Ink Supplies Problems

Most of the problems that you could encounter when working with the ink supplies are solved with guidance from the front panel. A full list of front panel messages are supplied in the User's Guide.

### Problems reseating the printhead

If you have inserted the printhead into the printhead carriage assembly and the printer does not "BEEP" try the following steps.

**Check that during the priming process, the Setup Printheads are installed in the Carriage. If the printing Printheads are installed in the carriage during the priming process, they will be rejected and the front panel will show a warning message.**

- Check that the protective tape has been removed from the printhead.
- Insert the Printhead into the Carriage Assembly but this time correctly close the cover using the latch.
- Clean the electrical contacts on both the printheads and the printhead Carriage Assembly using the carriage interconnect wiper ⇒ Page 3-14.
- Replace the Printhead with a new one.

### You Cannot Insert the Ink Cartridge Into the Printer

- 1 Ensure that you have the correct hp no.90 Ink Cartridge.
- 2 Ensure that the Ink Cartridge is the correct color for that slot.
- 3 Ensure that the Ink Cartridge is the correct orientation, with the color coded label at the top.

**Never clean inside the Ink Cartridge slots as this can cause damage to the Printer.**

### You Cannot Insert the Printhead Into the Printer

- 1 Ensure that you have the correct hp no.90 Printhead.
- 2 Ensure that the printhead is the correct color for that slot.
- 3 Ensure that the printhead is in the correct orientation.
- 4 Ensure that the protective cap is removed from the Printhead.

### You Cannot Insert the Printhead Cleaner Into the Printer

- 1 Ensure that you have the correct hp no.90 printhead cleaner.
- 2 Ensure that the printhead cleaner is the correct color for that slot.
- 3 Ensure that the printhead cleaner is in the correct orientation.

## Troubleshooting Printhead Error Codes

The Printhead Error Codes can be found on the Service Information Print (Setup Menu/Information Menu/Internal Prints/Print Service Information/Current Information). The actual error code is a decimal number and it has to be converted to a binary number before it can be used.



Error ID Code: 0 0 0 0 0 0 0 0 0 0 1 0 0 0 0 0 0 0 0 0

In order to convert the decimal error code to a binary error code, you can use a calculator. For example, if you had the error code 4099, you would enter 4099 as a decimal number and then select the binary option which would give you a binary number of 1000000000011.

The following table explains the meaning of the different bits (0 or 1). When the value of the error code is reported as 0, it means that the Printhead is working correctly:

Bit	Meaning	Bit	Meaning
1st	FAILS_LOGICAL_V	11th	BAD_ACUMEN_ACCESS
2nd	FAILS_CONTINUITY	12th	WRONG_MODEL
3rd	SHUTDOWN	13th	MISMATCH
4th	FAILS_VPP	14th	CSDATA_NOT_RESPONDING
5th	TEMP_EXTREMELY_HIGH	15th	CSDATA_TRANSMIT_ERROR
6th	TEMP_EXTREMELY_LOW	16th	FAILS_ENERGY_CALIBRATION
7th	TEMP_TOO_HIGH	17th	EMPTY_DUMMY
8th	TEMP_TOO_LOW	18th	FULL_DUMMY
9th	BAD_ACUMEN_INFO	19th	END_OF_LIFE
10th	NO_PEN	20th	OUT_OF_WARRANTY

The binary number needs to be read from right to left so that the 1st bit corresponds to the right one of the binary number. For example, the error code 4099 is converted to binary number 1000000000011. So using the table above, the error code means "FAILS\_LOGICAL\_V", "FAILS\_CONTINUITY" and "MISMATCH".

## Carriage Interconnect Wiper

**The Carriage Interconnect Wiper is part of the Maintenance Kit which can be ordered using Part Number Q1271-60420. All the instructions needed to use the Carriage Interconnect Wiper will be packaged with the kit.**

Whenever you replace the Printhead, check the empty slots to see if they need cleaning. In extreme circumstances, when a Printhead is inserted, it is possible that the Printer will not recognize it due to the build-up of ink on the electrical connection between the Printhead and the Carriage Assembly.

Included with the HP Designjet Printer, is a Carriage Interconnect Wiper. This tool is provided in a separate package. It also contains replacement sponges and an instruction sheet. This tool should be used for cleaning the electrical interconnects of both the Carriage Assembly and the Printhead.

If the front panel displays the message "Reset" or "Replace" next to the offending printhead, try cleaning the flex circuits of the Carriage and the Printheads.

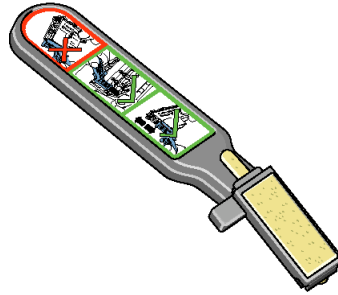

**Do not touch, wipe or attempt to clean the printhead nozzles. This can damage the printhead and reduce print quality.**



## Warranty Information for Ink Supplies

### Ink Cartridge

The warranty for the Ink Cartridges will end when one of the following occurs:

- 24 months from the date of manufacture
- or**
- When the advertised deliverable ink is reached (225ml/7.6 oz or 400ml/13.5 oz)
- or**
- When the user confirms that they have used non-hp ink in empty over-ride mode.

The actual end of warranty date is printed on the supply label.

## Warranty Information for Printheads

### Ink Cartridge

The warranty for the Printheads will end when one of the following occurs:

- 24 months from the date of manufacture that is printed on the Printhead
- or**
- When 1000ml/33.8 oz of HP original ink has been consumed by the Printhead
- or**
- When the user confirms that they have used non-hp ink in empty over-ride mode.



# Service Tests and Utilities

# 4

Introduction	4-2
Diagnostics - Self Test	4-2
Service Tests (Diagnostics)	4-3
Entering the Service Tests Menu	4-5
1. Scan Axis Test	4-7
2. Media Drive Test	4-12
3. Electronics Module Test	4-17
4. Carriage Assembly Test	4-27
5. Sensors Test	4-28
6. Ink Delivery System Test	4-32
7. SVS/Aerosol Fan Test	4-33
8. Air Pump System Test	4-34
9. Vacuum Fans Test	4-35
10.1 Others >>> Bag Broken Recovery	4-36
10.2 Others >>> IO Information	4-39
10.3 Others >>> Unit Information	4-40
10.4 Others >>> Check Ink Supplies	4-42
11. EEROM Reset	4-44
12. Set Unit Configuration	4-46
13. Error 71:19 Recovery	4-47
I/O Tests	4-49
Service Utilities	4-51
Entering the Service Utilities Menu	4-52
1. Turn Drive Roller	4-54
2. Prime Tubes	4-56
3. Set SN	4-60
4. Reset Life Counters	4-61
5. Diagnostic Print	4-63
6. Sleep Mode	4-64
7. Replace Cutter	4-65
8. Set RTC Clock	4-66
9. Carriage Setup	4-67

## Introduction

This chapter explains how to use the built-in Service Tests and Service Utilities and what to do if any of the Service Tests fail.

**If possible, always perform a Service Test on the component that you are about to replace, just to make sure that is the component that has failed. If the test on that component passes, there is no need to replace it.**

### Diagnostics - Self Test

#### Initialization Sequences

Whenever the Printer is switched ON, it automatically performs a series of internal self tests and mechanical initialization sequences. If any of the parts fail, a system error will appear and you should consult Chapter 2 - *System Error Codes*.

### Phone Support

**In certain circumstances, a Call Agent can try and troubleshoot the Printer by requesting the Customer to perform a Service Test via the phone. Using this process, it can be determined whether the Printer requires any on-site maintenance.**

**Remember that the Key combination for the Customer to Enter the Service Tests and Utilities is different from the one that the Customer Engineer will use.**

## Service Tests (Diagnostics)

The following is a list of all internal Service Tests available in the Printer. Instructions for entering the Service Tests menu are given on Page 4-5.

**1** Scan Axis Test ⇒ Page 4-7

The purpose of this test is to verify the operation of components related to the Scan Axis.

**2** Media Drive Test ⇒ Page 4-12

The purpose of this test is to verify the operation of components related to the Media Axis.

**3** Electronics System ⇒ Page 4-17

The purpose of this test is to verify the operation of the:

- Main PCA (Formatter).
- Printer Configuration.
- Gamut PCI PCA.
- Power Supply Unit.
- PrintMech.
- Interconnect PCA.
- Carriage Communication.
- ISS Communication.

**4** Carriage Assembly Test ⇒ Page 4-27

The purpose of this test is to verify the operation of the Carriage Assembly.

**5** Sensors Test ⇒ Page 4-28

The purpose of this test is to verify the operation of the following Sensors:

- Window Sensor.
- Printhead Cleaner (PHC) Access Door Sensor.
- Media Lever Sensor.
- Media Sensor.

**6** Ink Delivery System Test ⇒ Page 4-32

The purpose of this test is to verify the operation of the Ink Supply Tubes.

**7** SVS/Aerosol Fan Test ⇒ Page 4-33

The purpose of this test is to verify the operation of the Service Station and the Aerosol Fan.

**8** Air Pump System Test ⇒ Page 4-34

The purpose of this test is to verify the operation of the Air Pressurization System (APS).

**9** Vacuum Fan Test ⇒ Page 4-35

The purpose of this test is to verify the operation of the Vacuum Fans.

**10** Others ⇒ Page 4-36

This option allows you to:

- Recover the Printer from a Bag Broken error ⇒ Page 4-36.
- View the information relating to the IO ⇒ Page 4-39.
- View the Firmware Version, Part Number, Serial Number and PS Unit Configuration ⇒ Page 4-40.
- Verify which Ink Cartridges are valid for the purge process and what is their current available ink level ⇒ Page 4-42.

**11** EEROM Reset ⇒ Page 4-44

The purpose of this test is to reset the EEROM values.

**12** Set Unit Configuration ⇒ Page 4-46

The purpose of this test is to automatically configure the Printer either as Standard or Productivity.

**13** Error 71:19 Recovery ⇒ Page 4-47

The purpose of this utility is to set the Serial Number and Part Number in case both the Hard Disk Drive and the Ink Supply Tubes are replaced at the same time.

**14** I/O Tests ⇒ Page 4-49

The purpose of this test is to check the installed and active I/O Interfaces.

## Entering the Service Tests Menu

**In order to enter the Service Utility Menu, please refer to the instructions on Page 4-52.**

- 1 Make sure the printer is switched OFF from the power switch on the front of the printer and **NOT** from the power switch on the back of the printer.
- 2 For Call Agents who will request the User to Perform certain troubleshooting action, hold the **Down** arrow key and the **Cancel** key down and switch the printer **ON** using the front power switch. Wait until you hear one beep (usually after 5 seconds) before releasing ALL 3 keys.



- 3 For On-Site Engineers, hold the **Up** arrow key and the **Cancel** key down and switch the printer **ON** using the front power switch. Wait until you hear one beep (usually after 5 seconds) before releasing ALL 3 keys.



- 4 Once inside the Service Tests Menu use the **Arrow** keys to scroll through the "Service Tests" selections. Press the **Enter** key to begin a specific test when the required Service Test is highlighted.

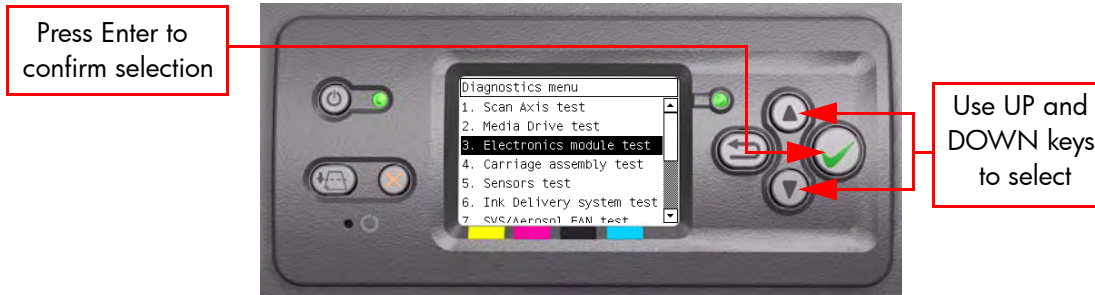

**The Service Tests work in a special Mode which does NOT require the full Initialization of the Printer. Therefore it is important that once you have finished with the Service Tests, you MUST power OFF the Printer and Power ON again before trying to print.**

**In some cases a quick press of a button may not be recognized by the Printer. When pressing a button, be sure to press it deliberately and all the way to the bottom of its travel.**

**If the Printer hangs up during a test, switch the Printer OFF and restart from step 1.**



**PHONE SUPPORT**

## 1. Scan Axis Test

The purpose of this test is to diagnose a failure in the operation of components related to the Scan Axis.

You must perform the Scan-Axis Test after:

- System Error Code 86:XX.
- System Error Code 42:XX.
- System Error Code 73:XX.
- System Error Codes related to Scan-Axis shutdown or Carriage jam.

**ALL THE COVER SENSORS ARE DISABLED WHEN IN THE SERVICE TESTS MENU. IF THE CARRIAGE IS MOVING IT WILL NOT STOP IF THE WINDOW IS OPENED, SO BE VERY CAREFUL NOT TO PUT YOUR HANDS INSIDE.**

**IF POSSIBLE ALWAYS PERFORM THIS TEST BEFORE REPLACING ANY COMPONENT OF THE SCAN-AXIS.**

Perform the Scan Axis test as follows:

**Perform this test with the Printheads and the Tubes System installed in order to get values that can be compared correctly.**

- 1 In the Service Tests submenu, scroll to "1. Scan Axis test" and press **Enter**.

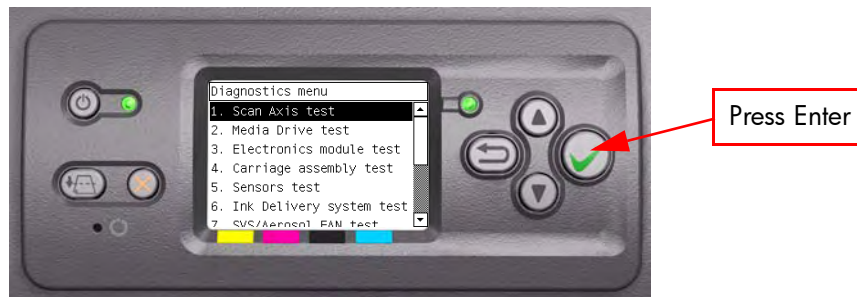

- 2 The Printer will start to initialize the Scan-Axis system and the Front Panel will display the following information:

- Starting Gamut.
- Starting Tests PWM.
- Starting Tests GPIO.
- Set GPIO psu\_lpm.

If there is a failure at this point, the Front Panel will display **System Error Code 01.0:10**. For more information on troubleshooting this error code, refer to Page 2-3.

- Checking voltage.

If there is a failure at this point, the Front Panel will display **System Error Code 03:10**. For more information on troubleshooting this error code, refer to Page 2-5. Check also **System Error Code 01.0:10** (refer to Page 2-3).

- Clear GPIO psu\_lpm.

If there is a failure at this point, the Front Panel will display **System Error Code 01.0:10**. For more information on troubleshooting this error code, refer to Page 2-3.

- Checking voltage.

If there is a failure at this point, the Front Panel will display **System Error Code 03:10**. For more information on troubleshooting this error code, refer to Page 2-5. Check also **System Error Code 01.0:10** (refer to Page 2-3).

- Config GPIO drv\_enable.

If there is a failure at this point, the Front Panel will display **System Error Code 01.0:10**. For more information on troubleshooting this error code, refer to Page 2-3.

- 3 After initializing the Scan-Axis system, the following message will appear on the Front Panel.

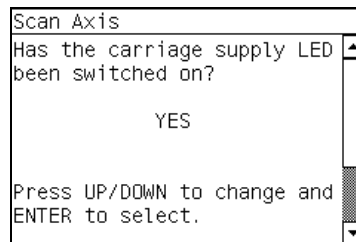

- 4 Open the Window and check that the Carriage power light is ON (a green light on the carriage PCA). Select **Yes** or **No** by using the **Up** and **Down** keys and press **Enter** to confirm your selection.

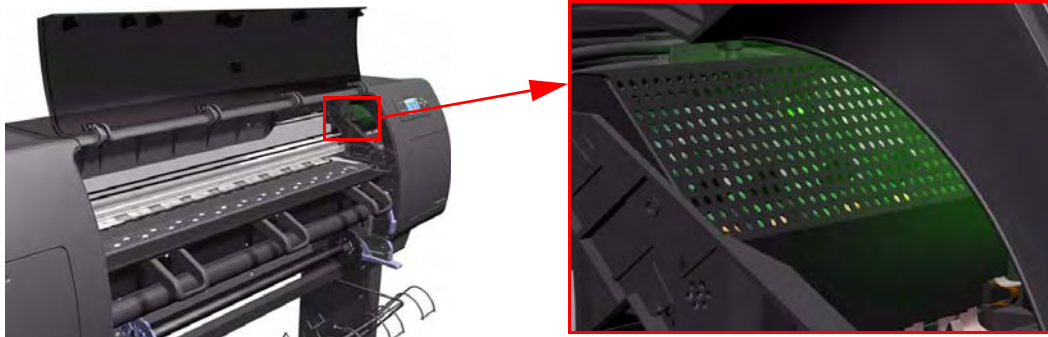

If you select **No** at this point, the Front Panel will display **System Error Code 02.1:10**. For more information on troubleshooting this error code, refer to Page 2-4. Check also **System Error Code 11:10** (refer to Page 2-7) or **System Error Code 07:10** (refer to Page 2-6).

If you select **Yes**, then the Front Panel will display:

- Booting up the Carriage.

If there is a failure at this point, the Front Panel will display **System Error Code 02.1:10**. For more information on troubleshooting this error code, refer to Page 2-4. Check also **System Error Code 11:10** (refer to Page 2-7) or **System Error Code 01.1:10** (refer to Page 2-3).

**Unit Hangs Up** - If no System error code is displayed on the Front Panel but the Printer hangs up and the last message on the Front Panel is "Booting up the Carriage" it means that the Carriage ASIC could not be detected. Troubleshoot this problem in the same way as if **System Error Code 02.1:10** had appeared.

- 5 Once the Carriage is booted up, the Service Station will be prepared and moved to a safe position so that the Carriage can be moved. During this process, the following information will be displayed on the Front Panel:
  - Starting SVS Motor.

If there is a failure at this point, the Front Panel will display **System Error Code 21:12**. For more information on troubleshooting this error code, refer to Page 2-8. Also, try to perform the Service Station Test (refer to Page 4-33).

**Unit Hangs Up** - If no System error code is displayed on the Front Panel but the Printer hangs up and the last message on the Front Panel is "Starting SVS Motor" it means that the SVS Motor could not be initialized. Troubleshoot this problem in the same way as if **System Error Code 21:12** had appeared.

- 6 The Printer will program the duty cycle for the PWM test for the Scan-Axis Movement and leave it disabled and the following information will be displayed on the Front Panel:
  - Prog slow PWM scan.
  - Moving carriage middle.
  - Prog fast PWM scan.

If there is a failure at this point, the Front Panel will display **System Error Code 01.0:10**. For more information on troubleshooting this error code, refer to Page 2-3.

- 7 The Carriage will be moved to the middle of the Center Platen. If there is a failure in moving the Carriage, the Front Panel will display **System Error Code 01.0:10**. For more information on troubleshooting this error code, refer to Page 2-3.

- 8 The printer will now check that it can read the Encoder Strip. When the following message appears on the Front Panel, open the Window and press the **Up** key to move the Carriage to the left and the **Down** key to move the Carriage to the right. Make sure that you move the Carriage in both directions and check that the Carriage actually moves when a key is pressed.

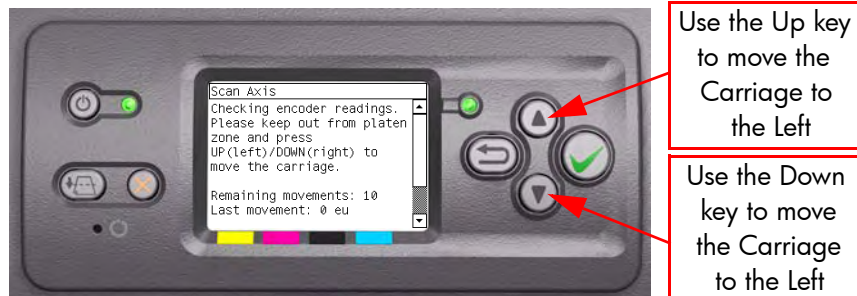

If there is a failure at this point, the Front Panel will display **System Error Code 01.0:10**. For more information on troubleshooting this error code, refer to Page 2-3. If the Carriage only moves in one direction, troubleshoot the problem as **System Error Code 01.1:10** (refer to Page 2-3).

- 9 At the end of 10 Carriage movements, the Front Panel will display the maximum and minimum length (in encoder units) of the 10 movements and the overall average.

```

Scan Axis
Max,Min mov: 1120,1086 eu
Avg mov: 1100 eu
There is encoder feedback.

Encoder seems to be OK.

Press any key to continue.

```

If Carriage movement has not been detected or if Carriage movement was very short, the Front Panel will ask you "Did the motor move?". If the answer is **Yes** (the Carriage had moved) press **Enter**. If the answer is No (the Carriage had not moved) press the **Back** key.

If you select **No** (the Carriage had not moved), the Front Panel will display **System Error Code 42:10**. For more information on troubleshooting this error code, refer to Page 2-14. Check also **System Error Code 01.1:10** (refer to Page 2-3) or **System Error Code 01.0:10** (refer to Page 2-3).

If you select **Yes** (the Carriage had moved), the Front Panel will display **System Error Code 02:10**. For more information on troubleshooting this error code, refer to Page 2-4. Check also **System Error Code 11:10** (refer to Page 2-7) or **System Error Code 01.0:10** (refer to Page 2-3).

If any max. or min. movement length is outside the + or - 20% average, then this warning message will be displayed on the Front Panel "Some movements out of avg +20% range: Intermittent movements. PWM test needed". This warning means that there is a mechanical problem in the Printer (Encoder Strip, friction, Carriage Belt, Slider Rod, etc...). Press any key to continue with the PWM test.

- 10 The Printer will now start to initialize the Scan-Axis servo and the Front Panel will display the following information:
- Starting Carriage Motor.
  - Off/On Carriage Motor.
  - Doing a right side bump.
  - Doing a left side bump
  - Exit bump position.

If there is a failure at this point, the Front Panel will display **System Error Code 86:10**. For more information on troubleshooting this error code, refer to Page 2-24.

- 11 The Printer checks the complete length of the Scan-Axis and displays the result on the Front Panel. The length has to be between **1158629** and **1164616**.

```

Scan Axis
Checking scan axis length.

Total length: 1162304.

Press any key to continue.

```

If it is shorter, it means that there is an obstacle blocking the Scan-Axis path and the Front Panel will display **System Error Code 86:11**. For more information on troubleshooting this error code, refer to Page 2-24.

If the length is longer, it means that the carriage has a datum broken or the Carriage Stopper is not installed and the Front Panel will display **System Error Code 02:10**. For more information on troubleshooting this error code, refer to Page 2-4.

**Make sure you keep your hands away from the Print Platen as the Carriage will be moving at high speed and you could injure yourself or damage the Carriage Assembly.**

- 12** The Printer will now check the Scan-Axis PWM and the following information will be displayed on the Front Panel:

- Starting Scan Axis.
- PWM test.

If there is a failure at this point, the Front Panel will display **System Error Code 86:10**. For more information on troubleshooting this error code, refer to Page 2-24.

- 13** The Printer will test the PWM at 61 ips and display the results on the Front Panel.

```

Scan Axis
PWM avg range: 0 to 31160
PWM avg got: 27798.8
PWM min diff limit: 3100
PWM min diff got: 8824

Press any key to finish.
    
```

If some of the results are incorrect, the Front Panel will show "High Friction". Depending on the actual results received, the following should be done:

- If **PWM avg got** is more than 31160 and **PWM min diff got** is less than 3100 then there is high friction along the Scan-Axis. In this case you should:
  - Clean the Slider Rods and Apply Oil along the complete axis of the Slider Rods. After applying the Oil, perform the test again.
  - Check that the Carriage Belt is installed correctly.
- If **PWM min diff got** is less than 3100 but **PWM avg got** is less than 31160 then there is a problem in the Scan-Axis. In this case you should:
  - Check that the Encoder Strip is clean. If necessary, clean Encoder Strip using a damp cloth.
  - Check that the Ink Supply Tubes and Trailing Cable is installed correctly.

If there is a failure processing the PWM results, the Front Panel will display **System Error Code 86:11**. In this case try repeating the test again.

- 14** Once the test is completed, OK will be displayed on the Front Panel.

**PHONE SUPPORT**

## 2. Media Drive Test

The purpose of this test is to diagnose a failure in the operation of components related to the Media Axis.

You must perform the Media Drive Test after:

- System Error Code 81:XX.
- System Error Code 41:XX.
- System Error Code 73:XX.

**IF POSSIBLE ALWAYS PERFORM THIS TEST BEFORE REPLACING ANY COMPONENT OF THE MEDIA-AXIS.**

Perform the Paper Axis test as follows:

- 1 In the Service Tests submenu, scroll to "2. Media Drive test" and press **Enter**.

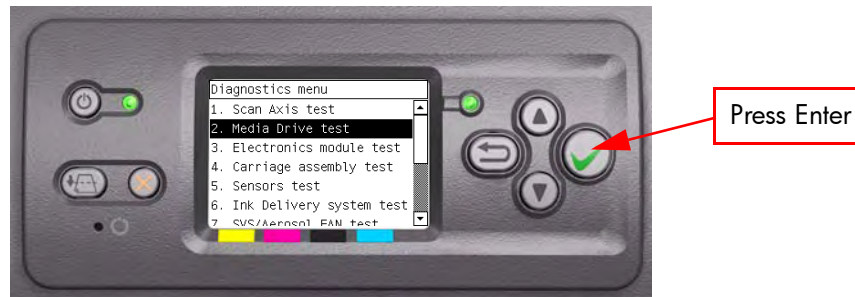

- 2 The Printer will start to initialize the Scan-Axis system and the Front Panel will display the following information:

- Starting Gamut.
- Starting Tests PWM.
- Starting Tests GPIO.
- Set GPIO psu\_lpm.

If there is a failure at this point, the Front Panel will display **System Error Code 01.0:10**. For more information on troubleshooting this error code, refer to Page 2-3.

- Checking voltage.

If there is a failure at this point, the Front Panel will display **System Error Code 03:10**. For more information on troubleshooting this error code, refer to Page 2-5. Check also **System Error Code 01.0:10** (refer to Page 2-3).

- Clear GPIO psu\_lpm.

If there is a failure at this point, the Front Panel will display **System Error Code 01.0:10**. For more information on troubleshooting this error code, refer to Page 2-3.

- Checking voltage.

If there is a failure at this point, the Front Panel will display **System Error Code 03:10**. For more information on troubleshooting this error code, refer to Page 2-5. Check also **System Error Code 01.0:10** (refer to Page 2-3).

- Config GPIO drv\_enable.

If there is a failure at this point, the Front Panel will display **System Error Code 01.0:10**. For more information on troubleshooting this error code, refer to Page 2-3.

- Booting up the Carriage.

If there is a failure at this point, the Front Panel will display **System Error Code 02.1:10**. For more information on troubleshooting this error code, refer to Page 2-4. Check also **System Error Code 11:10** (refer to Page 2-7) or **System Error Code 01.1:10** (refer to Page 2-3).

**Unit Hangs Up** - If no System error code is displayed on the Front Panel but the Printer hangs up and the last message on the Front Panel is "Booting up the Carriage" it means that the Carriage ASIC could not be detected. Troubleshoot this problem in the same way as if **System Error Code 02.1:10** had appeared.

- 3 The Printer will now check the revision of the PCA and the following message will be displayed on the Front Panel:

- Checking PCA rev.

The value for the PCA revision must be more than 0.625V, if not the Front Panel will display **System Error Code 01.1:10**. For more information on troubleshooting this error code, refer to Page 2-3.

- 4 The Printer will program the duty cycle for the PWM test for the Media Drive Movement and leave it disabled and the following message will be displayed on the Front Panel:

- Prog slow PWM paper.

If there is a failure at this point, the Front Panel will display **System Error Code 01.0:10**. For more information on troubleshooting this error code, refer to Page 2-3.

- 5 Before continuing, the following message will appear on the Front Panel. Remove the media if it is still loaded and make sure you stay out of the Print Platen area if the Window is open.

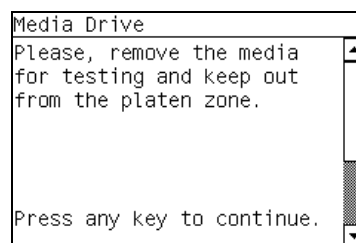

- 6 The Printer will now test the Media Drive moving in an open loop in one direction and the following message will be displayed on the Front Panel. Press any key to continue the test:

```
Media Drive
Checking Open Loop ROLL.
Movement done: 31298.
Press any key to continue.
```

Check that the movement done is more than 100 encoder units (in absolute value). If the movement done is less than 100 encoder units then open the Window and check for any visible obstacles restricting the movement of the Drive Roller or the Overdrive Assembly. In this case, press any key to finish the test.

- 7 The Printer will now test the Media Drive moving in an open loop in the opposite direction and the following message will be displayed on the Front Panel. Press any key to continue the test:

```
Media Drive
Checking Open Loop UNROLL.
Movement done: 30441.
Press any key to continue.
```

Check that the movement done is **more** than 100 encoder units (in absolute value). If the movement done is **less** than 100 encoder units then open the Window and check for any visible obstacles restricting the movement of the Drive Roller or the Overdrive Assembly.

If the Encoder Units is **less** than 100, the Printer will request you to follow these instructions:

- a Manually load a sheet of paper in to the Printer (an A4 sheet).
- b The Printer will test the Media Drive moving in an open loop.
- c Perform a visual check during the test. The Front Panel will ask you if the paper moved or not:
  - If the paper moved, the Front Panel will display **System Error Code 56:10**. For more information on troubleshooting this error code, refer to Page 2-17.
  - If the paper **did not** move, the Front Panel will display **System Error Code 41:10**. For more information on troubleshooting this error code, refer to Page 2-13.
- d A "FAIL" message will be displayed on the Front Panel and the test will be terminated at this point.



- 8 The Printer will now check the Media Drive servo system and the following messages will be displayed on the Front Panel:

- Starting Paper Motor.
- Off/On Paper Motor.
- Starting Paper Axis.

If there is a failure at this point, the Front Panel will display **System Error Code 81:10**. For more information on troubleshooting this error code, refer to Page 2-23.

- Calib. Analog Encoder.

If there is a failure at this point, the Front Panel will display **System Error Code 56:03**. For more information on troubleshooting this error code, refer to Page 2-17.

Once the Analog Encoder calibration is completed, the Front Panel will display the results:

```
Media Drive
Analog Encoder results:
CHANNEL  GAIN  OFFSET
A         005   019
B         005   019
Press BACK/CANCEL to reject
or ENTER to accept.
```

Acceptable values are:

- Gain: between 3 and 31.
- Offset: between 12 and 25.

If the results are acceptable, press **Enter**. If the results are unacceptable, then press the **Back/Cancel** key and the Front Panel will display **System Error Code 56:10**. For more information on troubleshooting this error code, refer to Page 2-17.

- Starting Media Path.

If there is a failure at this point, the Front Panel will display **System Error Code 81:10**. For more information on troubleshooting this error code, refer to Page 2-23.

- Homing and repeat. test.

If there is a failure at this point, the Front Panel will display **System Error Code 56:10**. For more information on troubleshooting this error code, refer to Page 2-17.

- 9 The Printer will now check the Media Drive PWM. You must load media in to the Printer and press any key to continue the test.

```
Media Drive
Please, raise the pinch
lever. Load the paper roll
and lower the pinch lever.
Press any key to proceed.
```

- 10** When the PWM check is being performed, the following message will be displayed on the Front Panel:
- PWM test with paper.
- 11** Once the PWM check is done, the results will be displayed on the Front Panel. Press any key to finish the test:

```
Media Drive
PWM avg: 16000 to 20000
PWM avg got: 16993.8
Speed error limit: 40
Speed error got: 25
PWM StDev: 1.00 to 850.00
PWM StDev got: 349.51
Press any key to finish.
```

If there is a failure at this point, the Front Panel will display:

```
Media Drive
WARNING: High Friction.
PWM avg: 16000 to 20000
PWM avg got: 13300.0
Speed error top limit: 40
Speed error got: 20
PWM StDev: 1.00 to 850.00
PWM StDev got: 120.53
Press any key to finish.
```

- 12** Once the test is completed, OK will be displayed on the Front Panel.

```
Media Drive
      00  K  K
     0 0  K  K
     0 0  K  K
     0 0  K  K
     0 0  K  K
     00  K  K
```

**PHONE SUPPORT**

### 3. Electronics Module Test

The purpose of this test is to diagnose a failure in the operation of the:

- Components of the Electronics Module.
- Electronics Module to Carriage and ISS Communication.

**This test does not test the EIO Card or the Hard Disk Drive.**

Perform the Electronics Module test as follows:

- 1 In the Service Tests submenu, scroll to "3. Electronics Module Test" and press **Enter**.

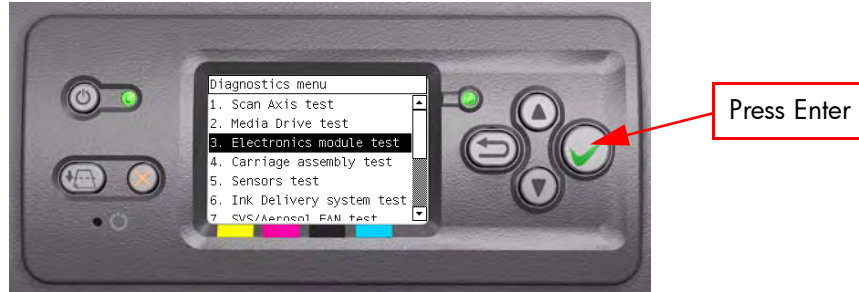

- 2 A message will appear on the Front Panel asking whether you would like to check the Formatter. Select **Yes** or **No** by using the **Up** and **Down** keys and press **Enter** to confirm your selection. If you select **No**, the printer skips this test and goes to the next one:

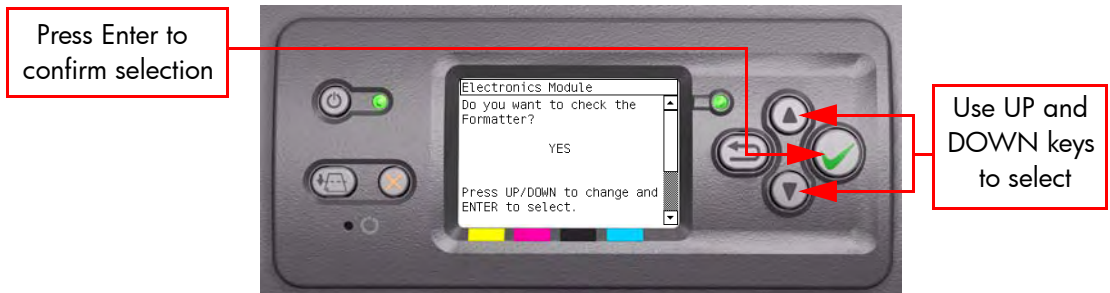

- 3 If you select **Yes**, the printer will get the CPU information and display the information on the Front Panel. Press any key to continue the test:

```

Electronics Module
CPU information:
Processor: 0, GenuineIntel
CPU family: 15, model 2
Name: Intel(R) Celeron(R)
CPU 2.00GHz
Stepping: 9
CPU MHz: 1999.793
Press any key to continue.
    
```

- 4 The printer will now get the Main Board (MB) information and display the information on the Front Panel. Press any key to continue the test:

```

Electronics Module
Main Board information:
Temp. (sys/CPU/amb):
  28.00/34.00/30.00
Volt (1.5/1.8/2.5/3.3):
  1.516/1.763/2.552/3.352
Volt (5/12/Vccp):
  5.078/11.875/1.500
Press any key to continue.
  
```

- 5 The printer will now get the CPU Fan Speed and display the information on the Front Panel. Press any key to continue the test:

```

Electronics Module

CPU Fan Speed: 5228

Press any key to continue.
  
```

If the CPU Fan Speed is less than 2500, the Front Panel will display **System Error Code 05.1:10**. For more information on troubleshooting this error code, refer to Page 2-5.

- 6 The printer will now calculate the amount of memory installed and display the information on the Front Panel. Press any key to continue the test:

```

Electronics Module

Main memory size: 256MB

Press any key to continue.
  
```

A minimum of 256 megabytes of memory must be installed in the Printer. If not, the Front Panel will display **System Error Code 05.3:10**. For more information on troubleshooting this error code, refer to Page 2-5.

- 7 A message will appear on the Front Panel asking whether you would like to check the Printer Configuration. Select **Yes** or **No** by using the **Up** and **Down** keys and press **Enter** to confirm your selection. If you select **No**, the printer skips this test and goes to the next one:

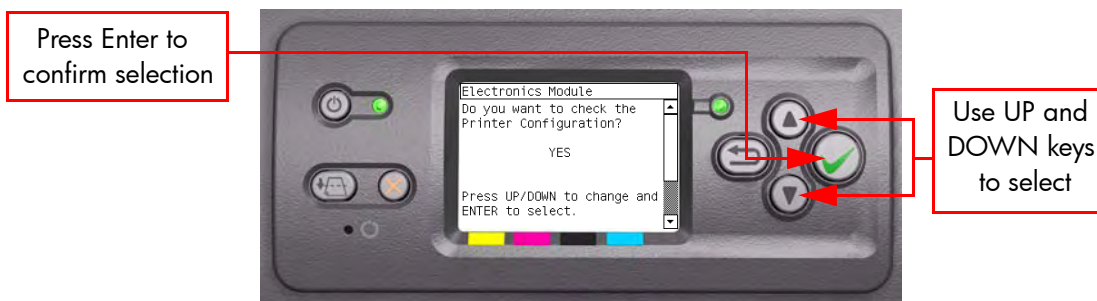

- 8 If you select **Yes**, the Printer will start the CDS and the following information will be displayed on the Front Panel:
- Starting CDS.

If there is a failure at this point, the Front Panel will display **System Error Code 79:03**. For more information on troubleshooting this error code, refer to Page 2-27.

- 9 The printer will then check the Serial Number and Part Number and display the information on the Front Panel. Press any key to continue the test:

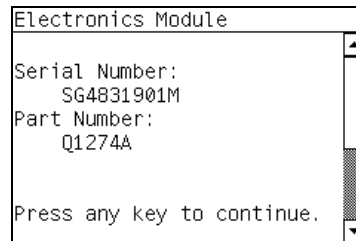

If the Serial Number or the Part Number cannot be read, the Front Panel will display **System Error Code 74:00**. For more information on troubleshooting this error code, refer to Page 2-20.

If the Serial Number does not have assigned a correct 10 character format or the Part number does not have assigned a correct 6 character format, a fail message will appear on the Front Panel. In this case, re-enter in to the Service Tests submenu and use the diagnostic "13. Error 71:19 Recovery" to set the correct Serial Number (refer to Page 4-47).

- 10 The Printer will now check the unit configuration (whether it is Standard or Productivity) and the Part Number and display the information on the Front Panel. Press any key to continue the test:

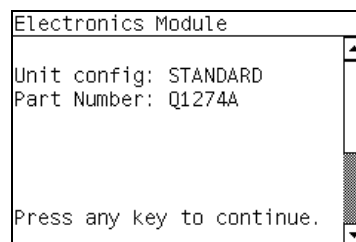

If the unit configuration is incorrect according to the part number, the Front Panel will display a fail message. In this case, re-enter in to the Service Tests submenu and use the diagnostic "12. Set Unit Configuration" to set the correct configuration (refer to Page 4-46).

- 11** A message will appear on the Front Panel asking whether you would like to check the Gamut. Select **Yes** or **No** by using the **Up** and **Down** keys and press **Enter** to confirm your selection. If you select **No**, the printer skips this test and goes to the next one:

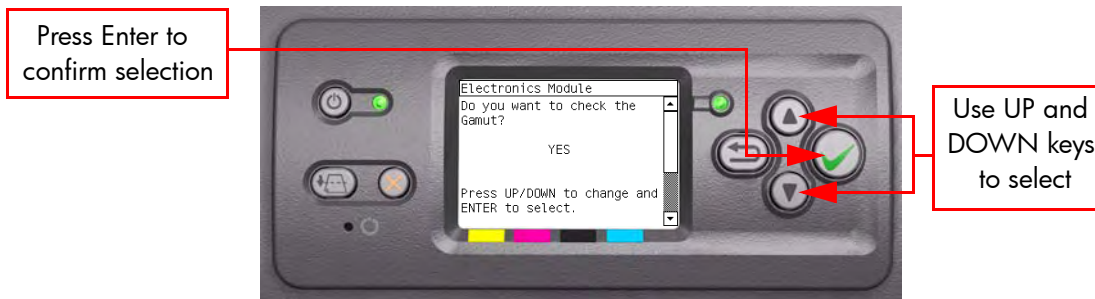

- 12** If you select **Yes**, the Printer will check the Gamut PCI PCA and the following messages will be displayed on the Front Panel:

- Checking Gamut PCI.
- Checking ARM Gamut.
- Starting Gamut.
- Checking Gamut memory I.
- Checking Gamut memory II.

If there is a failure at this point, the Front Panel will display **System Error Code 01.0:10**. For more information on troubleshooting this error code, refer to Page 2-3.

- 13** A message will appear on the Front Panel asking whether you would like to check the Power Supply. Select **Yes** or **No** by using the **Up** and **Down** keys and press **Enter** to confirm your selection. If you select **No**, the printer skips this test and goes to the next one:

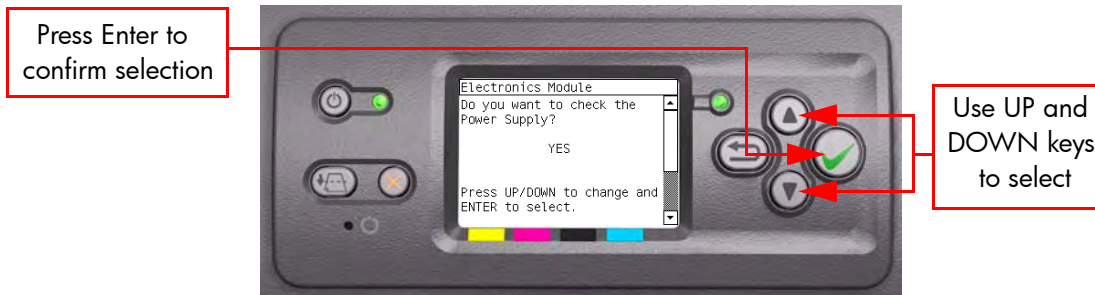

- 14** If you select **Yes**, the Printer will check the Power Supply Unit and the following messages will be displayed on the Front Panel:

- Starting Gamut.
- Starting Tests GPIO.
- Set GPIO psu\_lpm.

If there is a failure at this point, the Front Panel will display **System Error Code 01.0:10**. For more information on troubleshooting this error code, refer to Page 2-3.

- Checking voltage.

If there is a failure at this point, the Front Panel will display **System Error Code 03:10**. For more information on troubleshooting this error code, refer to Page 2-5.

- Clear GPIO psu\_lpm.

If there is a failure at this point, the Front Panel will display **System Error Code 01.0:10**. For more information on troubleshooting this error code, refer to Page 2-3.

- Checking voltage.

If there is a failure at this point, the Front Panel will display **System Error Code 03:10**. For more information on troubleshooting this error code, refer to Page 2-5.

- Starting CDS.

If there is a failure at this point, the Front Panel will display **System Error Code 79:03**. For more information on troubleshooting this error code, refer to Page 2-27.

- 15 A message will appear on the Front Panel asking whether you would like to check the PrintMech. Select **Yes** or **No** by using the **Up** and **Down** keys and press **Enter** to confirm your selection. If you select **No**, the printer skips this test and goes to the next one:

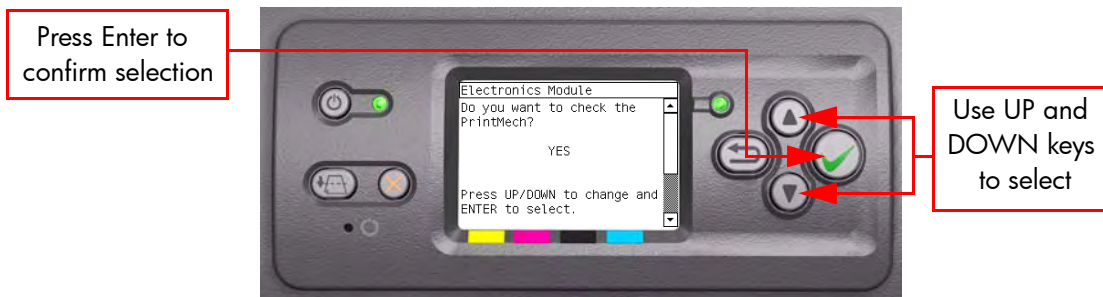

- 16 If you select **Yes**, the Printer will check the PrintMech and the following messages will be displayed on the Front Panel:

- Starting Gamut.
- Starting Tests GPIO.

If there is a failure at this point, the Front Panel will display **System Error Code 01.0:10**. For more information on troubleshooting this error code, refer to Page 2-3.

- Checking PCA rev.

The value for the PCA revision must be more than 0.625V, if not the Front Panel will display **System Error Code 01.1:10**. For more information on troubleshooting this error code, refer to Page 2-3.

- Clear GPIO psu\_lpm.

If there is a failure at this point, the Front Panel will display **System Error Code 01.0:10**. For more information on troubleshooting this error code, refer to Page 2-3.

- Disable Vacuum Fans.
- Checking Vacuum Fans.
- Enable Vacuum Fans.
- Checking Vacuum Fans.
- Disable Vacuum Fans.

If there is a failure at this point, the Front Panel will display either **System Error Code 01.0:10** or **System Error Code 01.1:10**. For more information on troubleshooting either of these error codes, refer to Page 2-3.

- Starting CDS.

If there is a failure at this point, the Front Panel will display **System Error Code 79:03**. For more information on troubleshooting this error code, refer to Page 2-21.

- Getting unit config.

If the Part Number cannot be read, the Front Panel will display **System Error Code 74:00**. For more information on troubleshooting this error code, refer to Page 2-20.

If the current Part Number is not in the correct 6 character format, the Front Panel will display a fail message. In this case, re-enter in to the Service Tests submenu and use the diagnostic "13. Error 71:19 Recovery" to set the correct Serial Number (refer to Page 4-47).

If the unit configuration is incorrect according to the part number, the Front Panel will display a fail message. In this case, re-enter in to the Service Tests submenu and use the diagnostic "12. Set Unit Configuration" to set the correct configuration (refer to Page 4-46).

- 17** A message will appear on the Front Panel asking whether you would like to check the Interconnect. Select **Yes** or **No** by using the **Up** and **Down** keys and press **Enter** to confirm your selection. If you select **No**, the printer skips this test and goes to the next one:

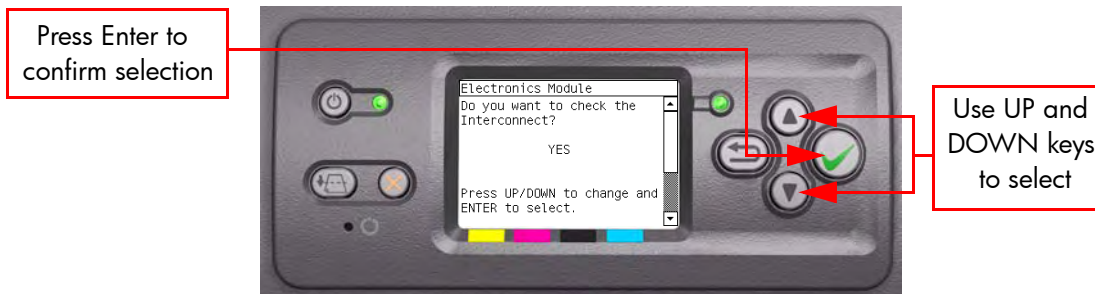

- 18** If you select **Yes**, the Printer will check the Interconnect PCA and the following messages will be displayed on the Front Panel:

- Starting CDS.



If there is a failure at this point, the Front Panel will display **System Error Code 79:03**. For more information on troubleshooting this error code, refer to Page 2-27.

#### ■ Getting unit config.

If the current Part Number is not in the correct 6 character format, the Front Panel will display a fail message. In this case, re-enter in to the Service Tests submenu and use the diagnostic "13. Error 71:19 Recovery" to set the correct Serial Number (refer to Page 4-47).

If the unit configuration is incorrect according to the part number, the Front Panel will display a fail message. In this case, re-enter in to the Service Tests submenu and use the diagnostic "12. Set Unit Configuration" to set the correct configuration (refer to Page 4-46).

#### ■ Starting Tests GPIO.

If there is a failure at this point, the Front Panel will display **System Error Code 01.0:10**. For more information on troubleshooting this error code, refer to Page 2-3.

#### ■ Checking GPIO channels.

At this stage, the Printer reads and checks the default GPIO values in the Interconnect PCA when all the cables are connected and all the sensors give the default value or the current state. The results will be displayed on the Front Panel and you can press any key to scroll through the information.

1

Electronics Module	
Revision Id 1:	0 OK
Revision Id 2:	0 OK
Revision Id 3:	0 OK
Window Sensor:	0 OK
SVS Door:	0 OK
Media Sensor:	0 OK
Press any key to continue.	

2

Electronics Module	
Pinch Lever:	0 OK
BT Standby:	0 OK
Sheet Sensor:*	1 OK
Back Channel Sensor:*	0 OK
Feed Pinch Lever 0:*	0 OK
Feed Pinch Lever 1:*	0 OK
Press any key to continue.	

3

Electronics Module	
Roll Box 0:*	1 OK
Roll Box 1:*	1 OK
Roll Box 2:*	1 OK
PM Check Cable:	0 OK
DD Goods:	0 OK
Media Jam Sensor:*	0 OK
Press any key to continue.	

4

Electronics Module	
Load Paper SW:*	0 OK
Press any key to continue.	

\* Items marked with an asterisk are not important and can be ignored.

If any of the channels cannot be read, the Front Panel will display **System Error Code 01.0:10**. For more information on troubleshooting this error code, refer to Page 2-3.

If any of the read values do not match the expected default, the Front Panel will display **System Error Code 07:10**. For more information on troubleshooting this error code, refer to Page 2-6.

- 19** A message will appear on the Front Panel asking whether you would like to check the Carriage Communication. Select **Yes** or **No** by using the **Up** and **Down** keys and press **Enter** to confirm your selection. If you select **No**, the printer skips this test and goes to the next one:

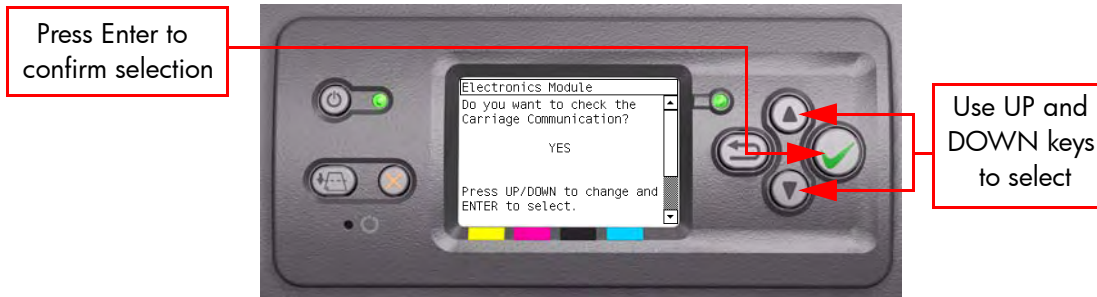

- 20** If you select **Yes**, the following message will appear on the Front Panel:

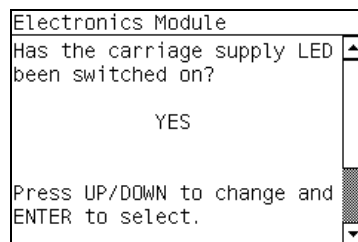

- 21** Open the Window and check that the Carriage power light is ON (a green light on the carriage PCA). Select **Yes** or **No** by using the **Up** and **Down** keys and press **Enter** to confirm your selection.



If you select **No** at this point, the Front Panel will display **System Error Code 07:10**. For more information on troubleshooting this error code, refer to Page 2-6. Check also **System Error Code 11:10** (refer to Page 2-7) or **System Error Code 02.1:10** (refer to Page 2-4).

If you select **Yes**, then the Front Panel will display:

- Starting Carriage.

If there is a failure at this point, the Front Panel will display **System Error Code 02.1:10**. For more information on troubleshooting this error code, refer to Page 2-4. Check also **System Error Code 11:10** (refer to Page 2-7) or **System Error Code 01.0:10** (refer to Page 2-3).

- Checking Carriage rev.

If there is a failure at this point, the Front Panel will display **System Error Code 02.1:10**. For more information on troubleshooting this error code, refer to Page 2-4. Check also **System Error Code 11:10** (refer to Page 2-7).

- 22** A message will appear on the Front Panel asking whether you would like to check the ISS Communication. Select **Yes** or **No** by using the **Up** and **Down** keys and press **Enter** to confirm your selection. If you select **No**, the printer skips this test and goes to the next one:

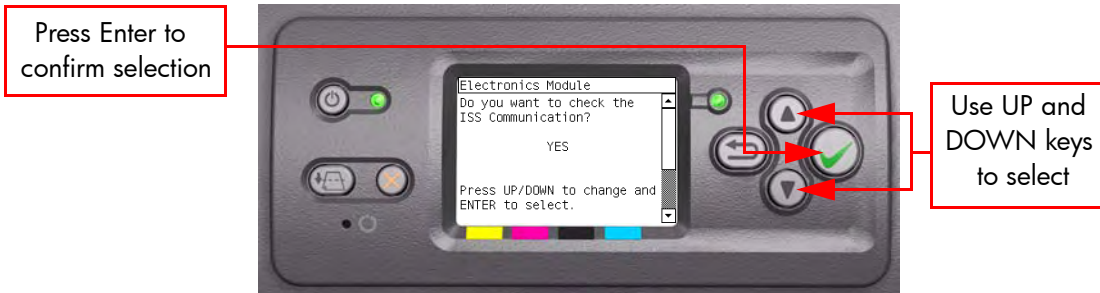

- 23** If you select **Yes**, the Printer will check the ISS Communication and the following information will be displayed on the Front Panel:

- Starting Gamut.

If there is a failure at this point, the Front Panel will display **System Error Code 01.0:10**. For more information on troubleshooting this error code, refer to Page 2-3.

- Checking ISS PCA rev.

The value for the ISS PCA revision must be more than 0.625V, if not the Front Panel will display **System Error Code 01.2:10**. For more information on troubleshooting this error code, refer to Page 2-4. Check also **System Error Code 01.0:10** (refer to Page 2-3)

If there is a problem in reading the values, the Front Panel will display **System Error Code 01.0:10**. For more information on troubleshooting this error code, refer to Page 2-3.

- 24** When the Front Panel displays the following message, open the Ink Cartridge Door and check that all the Ink cartridges are correctly installed. Press any key to continue.

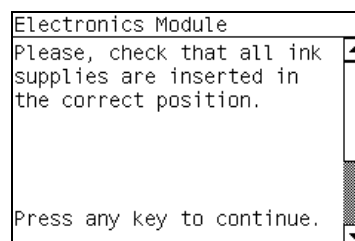

- 25** The Printer will continue with the ISS Communication test and the following messages will be displayed on the Front Panel:

- Starting ISS Ink Sup.

If there is a failure at this point, the Front Panel will display **System Error Code 13.n:10**. For more information on troubleshooting this error code, refer

to Page 2-7. Check also **System Error Code 01.2:10** (refer to Page 2-4) or **System Error Code 01.0:10** (refer to Page 2-3).

- Getting ISS data.

If there is a failure at this point, the Front Panel will display **System Error Code 74:00**. For more information on troubleshooting this error code, refer to Page 2-20.

- Checking ISS Ink Sup.

If there is a failure at this point, the Front Panel will display **System Error Code 26.n:10**. For more information on troubleshooting this error code, refer to Page 2-10. Check also **System Error Code 13.n:10** (refer to Page 2-7).

**26** Once the test is completed, OK will be displayed on the Front Panel.

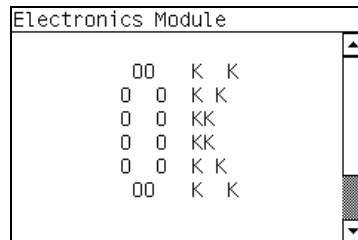

**PHONE SUPPORT**

## 4. Carriage Assembly Test

The purpose of this test is to verify the operation of the Carriage Assembly.

**IF POSSIBLE ALWAYS PERFORM THIS TEST BEFORE REPLACING THE CARRIAGE ASSEMBLY. IF THIS TEST PASSES, DO NOT REPLACE THE CARRIAGE ASSEMBLY.**

Perform the Carriage Assembly test as follows:

- 1 In the Service Tests submenu, scroll to "4. Carriage Assembly Test" and press **Enter**.

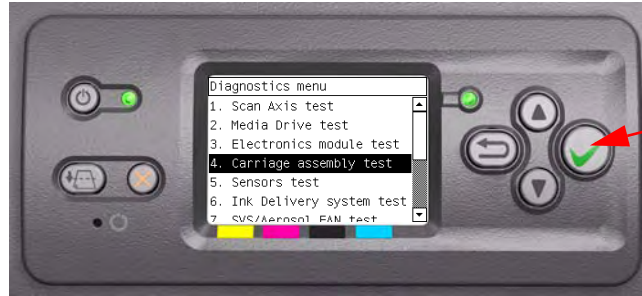

- 2 This test has not yet been implemented.

**PHONE SUPPORT**

## 5. Sensors Test

The purpose of this test is to verify the operation of the following Sensors:

- Window Sensor.
- Printhead Cleaner (PHC) Access Door Sensor.
- Media Lever Sensor.
- Media Sensor.

**IF POSSIBLE ALWAYS PERFORM THIS TEST BEFORE REPLACING A RELEVANT SENSOR. IF THIS TEST PASSES, DO NOT REPLACE THE RELEVANT SENSOR.**

Perform the Sensors test as follows:

- 1 Before starting, first make sure that:
  - The Window is closed.
  - The Printhead Cleaner Access Door is closed.
  - The Media Lever is in the lowered position.
  - Media is loaded.
- 2 In the Service Tests submenu, scroll to "5. Sensors Test" and press **Enter**.

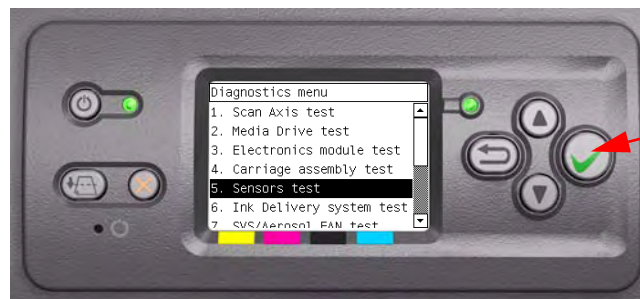

- 3 The Printer will start to initialize and the Front Panel will display the following messages:
  - Starting Gamut.
  - Starting Tests GPIO.

If there is a failure at this point, the Front Panel will display **System Error Code 01.0:10**. For more information on troubleshooting this error code, refer to Page 2-3.

- 4 Before starting to test the sensors, the following message will be displayed. Press any key to continue:

```
Sensors
Test of sensors.
Default conditions are:
-Window Closed
-Right Door Closed
-Pinch Wheel Down
-Paper Loaded
Press any key to continue.
```

- 5 The Window Sensor will be tested first. When the following message is displayed on the Front Panel, open the Window and press any key to continue.

```

Sensors
Test of Window sensor...
Please, open the cover.

Press any key to continue.
  
```

- 6 If the Window Sensor passes the test, the following message is displayed on the Front Panel. Close the Window and press any key to continue.

```

Sensors
Test of Window sensor PASS.
Please, close the cover.

Press any key to continue.
  
```

If the Window Sensor fails the test, the Front Panel will display **System Error Code 51:10**. For more information on troubleshooting this error code, refer to Page 2-15. Check also **System Error Code 07:10** (refer to Page 2-6).

- 7 The PHC Access Door Sensor will be tested next. When the following message is displayed on the Front Panel, open the PHC Access Door and press any key to continue.

```

Sensors
Test of PHC Access Door
sensor...
Please, open the right
door.

Press any key to continue.
  
```

- 8 If the PHC Access Door Sensor passes the test, the following message is displayed on the Front Panel. Close the PHC Access Door and press any key to continue.

```

Sensors
Test of PHC Access Door
sensor PASS.
Please, close the right
door.

Press any key to continue.
  
```

If the PHC Access Door Sensor fails the test, the Front Panel will display **System Error Code 51.1:10**. For more information on troubleshooting this error code, refer to Page 2-15. Check also **System Error Code 07:10** (refer to Page 2-6).

- 9 The Media Lever Sensor will be tested next. When the following message is displayed on the Front Panel, raise the Media Lever and press any key to continue.

```

Sensors
Test of Pinchwheel Lever
sensor...

Please, raise the lever.

Press any key to continue.

```

- 10 If the Media Lever Sensor passes the test, the following message is displayed on the Front Panel. Lower the Media Lever and press any key to continue.

```

Sensors
Test of Pinchwheel Lever
sensor PASS.

Please, lower the lever.

Press any key to continue.

```

If the Media Lever Sensor fails the test, the Front Panel will display **System Error Code 54:10**. For more information on troubleshooting this error code, refer to Page 2-16. Check also **System Error Code 07:10** (refer to Page 2-6).

- 11 The Media Lever Sensor will be tested next. When the following message is displayed on the Front Panel, raise the Media Lever and remove the Media from the Printer and press any key to continue.

```

Sensors
Test of Paper sensor...

Please, remove the paper
and lower the lever.

Press any key to continue.

```

- 12 If the Media Lever Sensor passes the test, the following message is displayed on the Front Panel. Press any key to continue.

```

Sensors
Test of Paper sensor PASS.

Press any key to continue.

```

If the Media Lever Sensor fails the test, the Front Panel will display **System Error Code 53:10**. For more information on troubleshooting this error code, refer to Page 2-16. Check also **System Error Code 07:10** (refer to Page 2-6).



If there is a failure in reading the GPIO channel, the Front Panel will display **System Error Code 01.0:10**. For more information on troubleshooting this error code, refer to Page 2-3. Check also **System Error Code 07:10** (refer to Page 2-6).

- 13 Once the test is completed, OK will be displayed on the Front Panel.

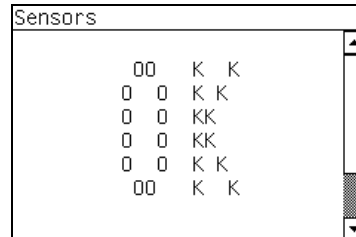

**PHONE SUPPORT**

## 6. Ink Delivery System Test

The purpose of this test is to verify the operation of the Ink Delivery System. Perform the Ink Delivery System test as follows:

- 1 In the Service Tests submenu, scroll to "6. Ink Delivery System Test" and press **Enter**.

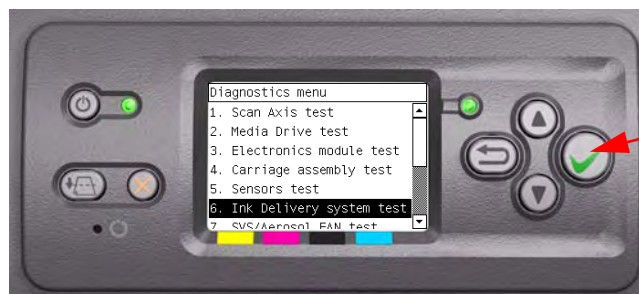

- 2 This test has not yet been implemented.

**PHONE SUPPORT**

## 7. SVS/Aerosol Fan Test

The purpose of this test is to verify the operation of the Service Station and the Aerosol Fan.

**IF POSSIBLE ALWAYS PERFORM THIS TEST BEFORE REPLACING THE SERVICE STATION/AEROSOL FAN. IF THIS TEST PASSES, DO NOT REPLACE THE SERVICE STATION/AEROSOL FAN.**

Perform the SVS/Aerosol Fan test as follows:

- 1 In the Service Tests submenu, scroll to "7. SVS/Aerosol Fan Test" and press **Enter**.

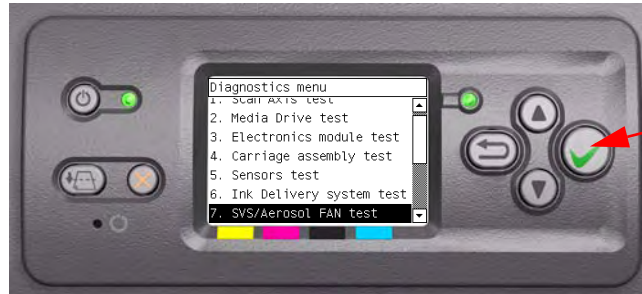

- 2 This test has not yet been implemented.

**PHONE SUPPORT**

## 8. Air Pump System Test

The purpose of this test is to verify the operation of the Air Pressurization System (APS).

**IF POSSIBLE ALWAYS PERFORM THIS TEST BEFORE REPLACING THE APS. IF THIS TEST PASSES, DO NOT REPLACE THE APS.**

Perform the Air Pump System test as follows:

- 1 In the Service Tests submenu, scroll to "8. Air Pump System Test" and press **Enter**.

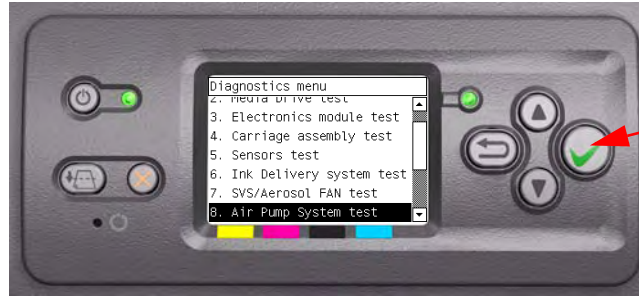

- 2 This test has not yet been implemented.

**PHONE SUPPORT**

## 9. Vacuum Fans Test

The purpose of this test is to verify the operation of the Vacuum Fans.

**IF POSSIBLE ALWAYS PERFORM THIS TEST BEFORE REPLACING THE VACUUM FAN. IF THIS TEST PASSES, DO NOT REPLACE THE VACUUM FAN.**

Perform the Vacuum Fans test as follows:

- 1 In the Service Tests submenu, scroll to "9. Vacuum Fans Test" and press **Enter**.

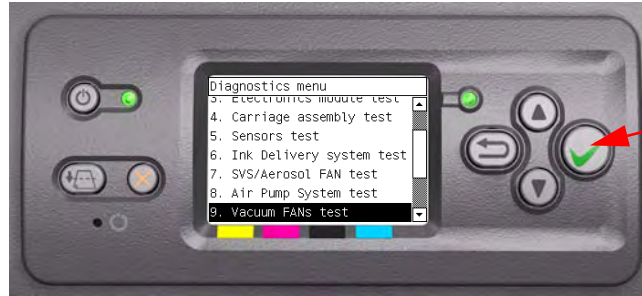

- 2 This test has not yet been implemented.

**PHONE SUPPORT**

## 10.1 Others >>> Bag Broken Recovery

This option allows to recover the Printer from a Bag Broken error.  
Perform the Bag Broken Recovery as follows:

- 1 In the Service Tests submenu, scroll to "10. Others" and press **Enter**.

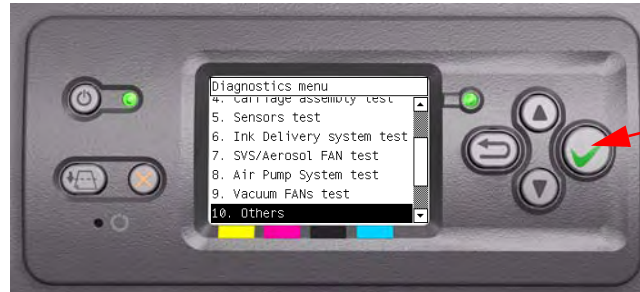

- 2 In the Others submenu, scroll to "10.1 Bag Broken Recovery" and press **Enter**.



- 3 The Printer will start to initialize and the Front Panel will display the following messages:

- Starting Gamut.
- Starting TestGPIO.

If there is a failure at this point, the Front Panel will display **System Error Code 01.0:10**. For more information on troubleshooting this error code, refer to Page 2-3.

- 4 The Printer will now detect for a broken bag in the Ink cartridges and the Front Panel will display the following messages:

- Detecting Bag Broken.

If the Printer does not detect that any of the Ink cartridges have a broken bag, then the message "No ink short detected on supplies" will be displayed on the Front Panel.

If there is a problem while reading the Bag Broken signal, the Front Panel will display **System Error Code 01.0:10**. For more information on troubleshooting this error code, refer to Page 2-3. Check also **System Error Code 01.2:10** (refer to Page 2-4).

If the Printer detects that one or more of the Ink Cartridges have a broken bag, then the message "Please, replace one of the defective cartridges (0, 1, 2 or 3) and press any key to continue" will be displayed on the Front Panel. In this case, remove the faulty Ink Cartridge as indicated by the Front Panel and install a new Ink Cartridge.

0 = Yellow  
1 = Magenta  
2 = Black  
3 = Cyan

If the Bag Broken error is still active even after replacing the faulty Ink cartridge, the Front Panel will display **System Error Code 01.2:10**. For more information on troubleshooting this error code, refer to Page 2-4. Check also **System Error Code 01.0:10** (refer to Page 2-3).

- 5 If the Printer does not detect that any of the Ink cartridges have a broken bag, then it will read the Acumen of the Ink cartridge to check if there had been an ink short previously. During this check, the Front Panel will display the following messages:

- Starting AcumenSupplies.
- Getting ISS data.

If the Printer does not detect that any of the Ink Cartridges previously had a Bag Broken error, then the message "No Broken Bag detected on supplies" will be displayed on the Front Panel.

If there is a problem while reading the Acumen, the Front Panel will display **System Error Code 26.n:10**. For more information on troubleshooting this error code, refer to Page 2-10. Check also **System Error Code 13.n:10** (refer to Page 2-7), **System Error Code 01.2:10** (refer to Page 2-4) or **System Error Code 01.0:10** (refer to Page 2-3).

If it is not possible to get the ISS Data, the Front Panel will display **System Error Code 74:00**. For more information on troubleshooting this error code, refer to Page 2-20.

If the Printer detects that an Ink Cartridge had previously experienced a Bag Broken error, the Front Panel will display **System Error Code 26.n:10**. For more information on troubleshooting this error code, refer to Page 2-10. Check also **System Error Code 01.2:10** (refer to Page 2-4) or **System Error Code 01.0:10** (refer to Page 2-3).

- 6 If no Ink Cartridges have been identified with Bag Broken, the Printer will try a Self Recovery test. When the following message is displayed on the Front Panel, remove the Left Cover and check if the tubes from the APS to the ISS are clean. Select **Yes** or **No** by using the **Up** and **Down** keys and press **Enter** to confirm your selection.

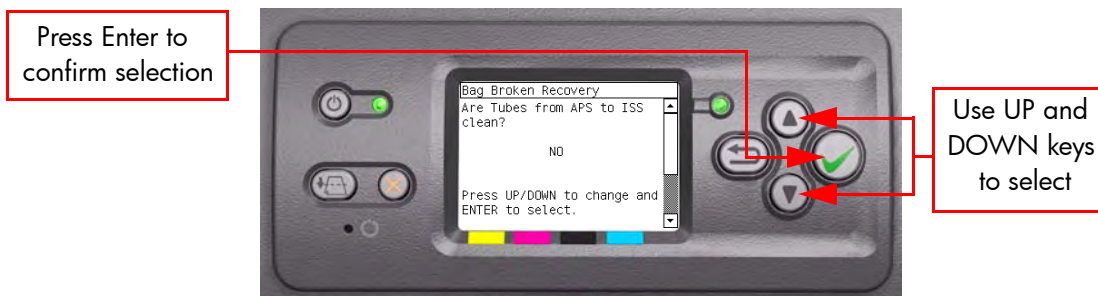

If you select **No**, the Front Panel will display **System Error Code 23:10**. For more information on troubleshooting this error code, refer to Page 2-8.

- 7** If you select **Yes**, the following message will appear on the Front Panel. Check if the Ink Supply Tubes from the ISS to the Carriage contain visible air. Select **Yes** or **No** by using the **Up** and **Down** keys and press **Enter** to confirm your selection.

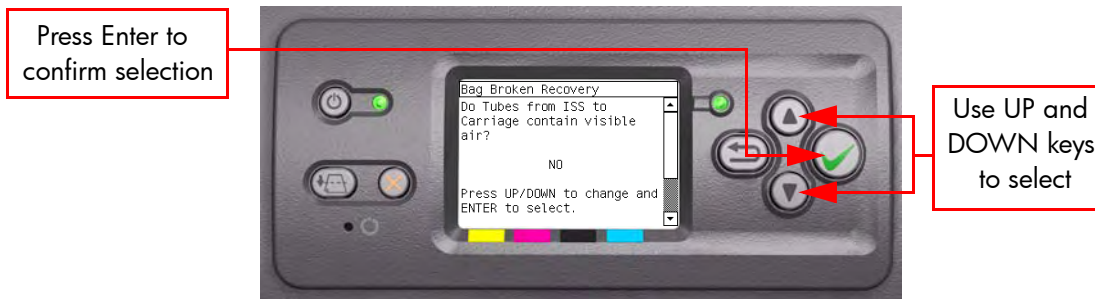

If you select **Yes**, the Front Panel will display **System Error Code 24:10**. For more information on troubleshooting this error code, refer to Page 2-9.

- 8** If you select **No**, the following message will appear on the Front Panel. You can now remove the Broken Bag condition causing the initial problem. Select **Yes** or **No** by using the **Up** and **Down** keys and press **Enter** to confirm your selection.

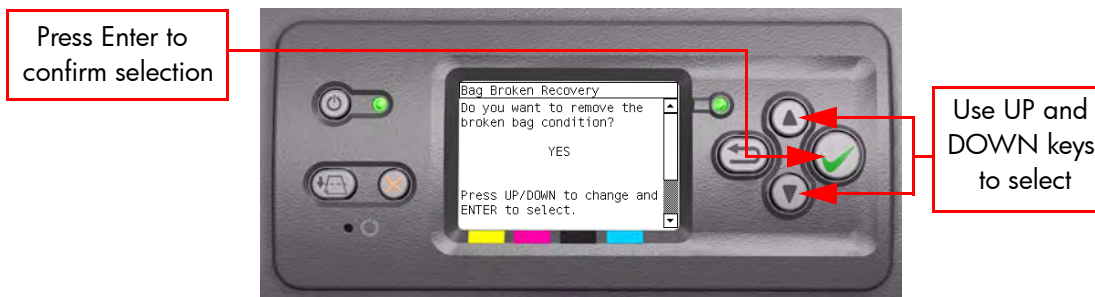

- 9** If you select Yes, the following messages will appear on the Front Panel:

■ Start Supplies Conf.

If there is a problem at this stage, the Front Panel will display **System Error Code 01.0:10**. For more information on troubleshooting this error code, refer to Page 2-3.

■ Removing leakage.

- 10** Once the process is completed, OK will be displayed on the Front Panel.

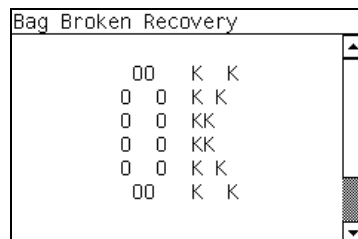



**PHONE SUPPORT**

## 10.2 Others >>> IO Information

This option allows you to view the information relating to the IO.

View the IO Information as follows:

- 1 In the Service Tests submenu, scroll to "10. Others" and press **Enter**.

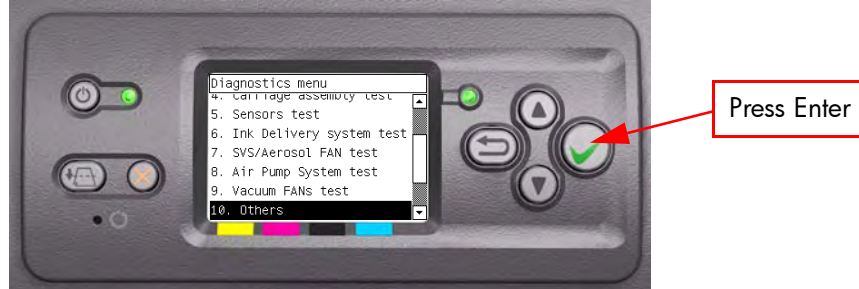

- 2 In the Others submenu, scroll to "10.2 IO Information" and press **Enter**.

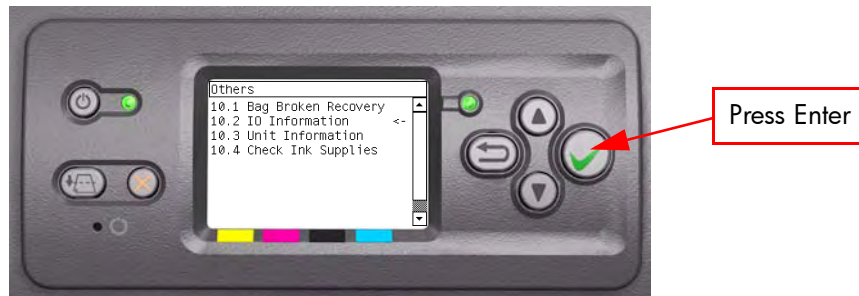

- 3 The Printer will start to initialize and the Front Panel will display the following messages:

- Getting IO Interface.
- Getting Interface info.

If there is a failure at this point, the Front Panel will display **System Error Code 74:00**. For more information on troubleshooting this error code, refer to Page 2-20.

If no active interface is found, the Front Panel will display "No active interface found. Press any key to finish".

- 4 Once the IO information is obtained, it is displayed on the Front Panel. Press any key to exit.

```

IO Information
IP:          16.23.60.239
Gateway:    16.23.56.1
Net Mask:   255.255.248.0

Press any key to finish.
    
```

- 5 Once the process is completed, OK will be displayed on the Front Panel.

**PHONE SUPPORT**

### 10.3 Others >>> Unit Information

This option allows you to view the following Printer information:

- Firmware version.
- Serial Number.
- Part Number.
- PS Language (for HP Designjet 4000PS)

View the Unit Information as follows:

- 1 In the Service Tests submenu, scroll to "10. Others" and press **Enter**.

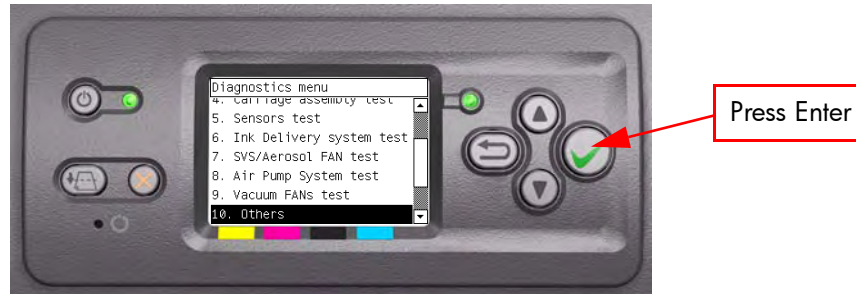

- 2 In the Others submenu, scroll to "10.3 Unit Information" and press **Enter**.



- 3 The Printer will start to initialize and the Front Panel will display the following messages:

- Starting Nvm.
- Getting FW version.
- Getting Serial Number
- Getting Part Number.

If there is a failure at this point, the Front Panel will display **System Error Code 79:03**. For more information on troubleshooting this error code, refer to Page 2-21.

If the Serial Number does not have assigned a correct 10 character format or the Part number does not have assigned a correct 6 character format, a fail message will appear on the Front Panel. In this case, re-enter in to the Service Tests submenu and use the diagnostic "13. Error 71:19 Recovery" to set the correct Serial Number (refer to Page 4-47).

- Getting PS Language (for HP Designjet 4000PS).

If there is a failure at this point, the Front Panel will display **System Error Code 74:00**. For more information on troubleshooting this error code, refer to Page 2-20.

- 4 Once the Unit information is obtained, it is displayed on the Front Panel.  
Press any key to exit.

```
Unit Information
FW version:   GW_3.1.1.2
Serial Number: SG4831901M
Part Number:  Q1274A
PS Language:  Roman
Press any key to finish.
```

- 5 Once the process is completed, OK will be displayed on the Front Panel.

```
Unit Information
          00  K  K
         0 0  K  K
         0 0  KK
         0 0  KK
         0 0  K  K
          00  K  K
```

**PHONE SUPPORT**

## 10.4 Others >>> Check Ink Supplies

The purpose of this test is to verify which Ink Cartridges are valid for the purge process and what is their current available ink level. Some Ink Cartridges may not be able to be accessed (unable to read the Acumen) if previously there had been a failure (faulty, broken bag, etc...).

View the Unit Information as follows:

- 1 In the Service Tests submenu, scroll to "10. Others" and press **Enter**.

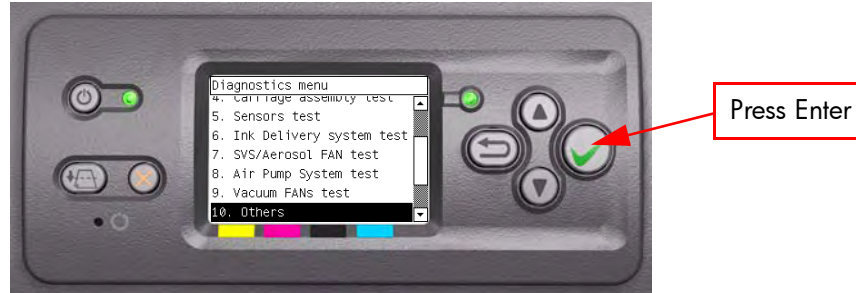

- 2 In the Others submenu, scroll to "10.4 Check Ink Supplies" and press **Enter**.

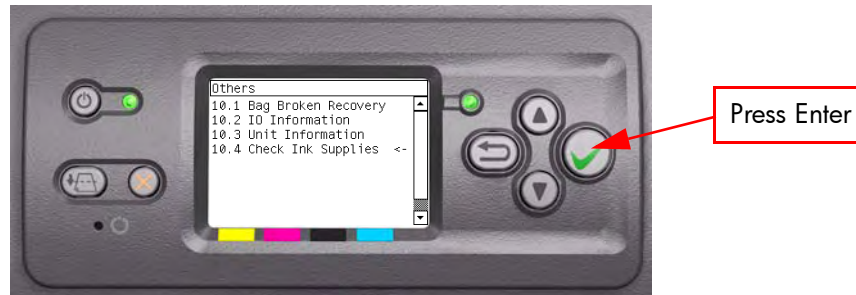

- 3 The Printer will start to initialize and the Front Panel will display the following messages:

- Starting Gamut.

If there is a failure at this point, the Front Panel will display **System Error Code 01.0:10**. For more information on troubleshooting this error code, refer to Page 2-3.

- Starting AcumenSupplies.

If there is a problem while reading the Acumen, the Front Panel will display **System Error Code 26.n:10**. For more information on troubleshooting this error code, refer to Page 2-10. Check also **System Error Code 13.n:10** (refer to Page 2-7), **System Error Code 01.2:10** (refer to Page 2-4) or **System Error Code 01.0:10** (refer to Page 2-3).

- Reading Ink Supplies.

If there is a failure at this point, the Front Panel will display the message "Replace failing ink supplies after running this utility: (Yellow, Magenta, Black or Cyan)".

- Once the Ink Supplies information is obtained, it is displayed on the Front Panel. Press any key to exit.

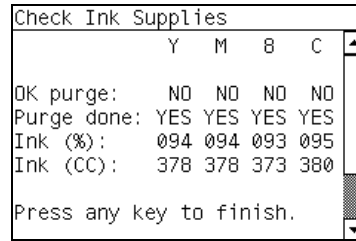

If any part of the Acumen information is invalid, the Front Panel will display **System Error Code 74:00**. For more information on troubleshooting this error code, refer to Page 2-20.

- Once the process is completed, OK will be displayed on the Front Panel.

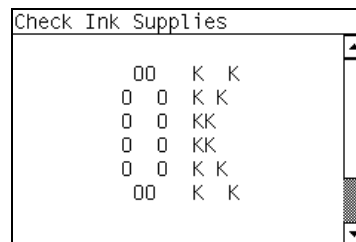

**PHONE SUPPORT**

## 11. EEROM Reset

The purpose of this diagnostic is to reset the EEROM values.

**Once the EEROM has been reset, the Printer will act as if it is being started for the first time, except that the Ink Supply Tubes have already been primed.**

Perform an EEROM Reset as follows:

- 1 In the Service Tests submenu, scroll to "11. EEROM Reset" and press **Enter**.

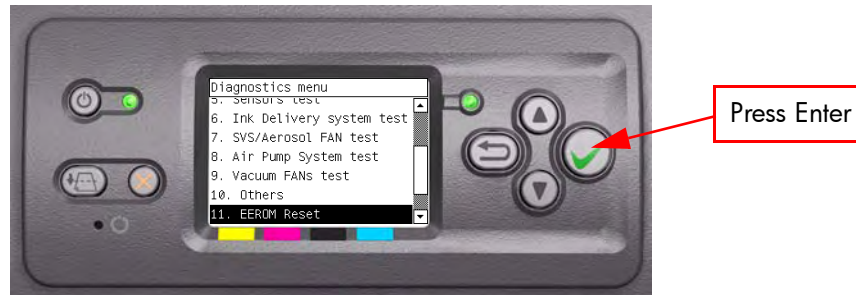

- 2 A message will appear on the Front Panel advising you that all user information/files will be removed. If you would like to proceed select **Yes** or **No** by using the **Up** and **Down** keys and press **Enter** to confirm your selection. If you select **No**, the process will end at this point.

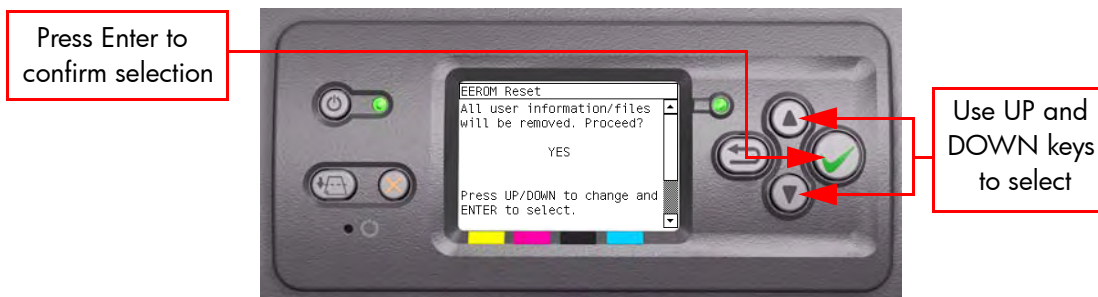

- 3 If you select **Yes**, the Printer will begin the process to reset the EEROM and the following messages will appear on the Front Panel:

- Starting Gamut.

If there is a failure at this point, the Front Panel will display **System Error Code 01.0:10**. For more information on troubleshooting this error code, refer to Page 2-3.

- Starting NVM.
- Setting default config.
- Restoring tubes state.

If there is a failure at this point, the Front Panel will display **System Error Code 79:03**. For more information on troubleshooting this error code, refer to Page 2-21.

- 4 Once the EEROM has been reset, the following message will appear on the Front Panel. Press any key to continue.

```

EEROM Reset
After rebooting there will
be a printhead error.
Please, select printhead
replacement to launch the
printhead calibration.

Press any key to continue.
    
```

**After rebooting the Printer, make sure you select Printhead replacement through the Front Panel in order to launch the Printhead calibration.**

- 5 Once the process is completed, OK will be displayed on the Front Panel.

```

EEROM Reset

      00  K  K
     0 0  K K
    0 0  KK
    0 0  KK
    0 0  K K
     00  K  K
    
```

**PHONE SUPPORT**

## 12. Set Unit Configuration

The purpose of this test is to automatically configure the Printer either as Standard or Productivity.

Set the Unit Configuration as follows:

- 1 In the Service Tests submenu, scroll to "12. Set Unit Configuration" and press **Enter**.

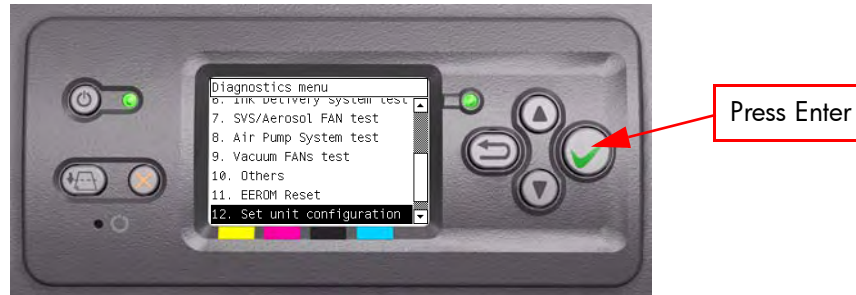

- 2 The Printer will start the configuration process and the Front Panel will display the following messages:
  - Starting Nvm.
  - Getting Part Number: (will show either Q1273A/Q1274A or Q1271A/Q1272A).

If there is a failure at this point, the Front Panel will display **System Error Code 79:03**. For more information on troubleshooting this error code, refer to Page 2-27.

- 3 The following message will be displayed on the Front Panel. Press any key to finish the configuration.

```

Set Unit Configuration
Starting Nvm.
Getting Part Number: Q1274A
Setting new config:

        STANDARD

Press any key to continue.
  
```

If there is a failure at this point, the Front Panel will display **System Error Code 79:03**. For more information on troubleshooting this error code, refer to Page 2-27.

- 4 Once the process is completed, OK will be displayed on the Front Panel.

```

Set Unit Configuration

        00  K  K
         0 0  K K
         0 0  KK
         0 0  KK
         0 0  K K
         00  K  K
  
```



**PHONE SUPPORT**

### 13. Error 71:19 Recovery

The purpose of this utility is to set the Serial Number and Part Number in case both the Hard Disk Drive and the Ink Supply Tubes are replaced at the same time.

Set the Serial Number as follows:

- 1 In the Service Tests submenu, scroll to "Error 71:19 Recovery" and press **Enter**.

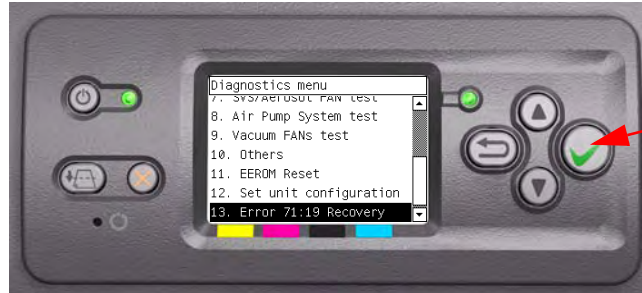

- 2 The Printer will check if the System Error Code 71:19 has been recorded and the following message will appear on the Front Panel:
  - Checking SE log.

If the Printer fails to find the System Error Code 71:19, the Front Panel will display **Error: Utility not available**. In this case press any key to exit.

- 3 If System Error Code is detected, the Printer will start the recovery procedure and the following messages will be displayed on the Front Panel:
  - Starting NvmBackup.
  - Starting NvmMain.
  - Getting Serial Number.
  - Checking Serial Number.
  - Starting Nvm.
  - Getting Part Number.

If there is a failure at this point, the Front Panel will display **System Error Code 79:03**. For more information on troubleshooting this error code, refer to Page 2-21.

- 4 The Printer will display the current Serial Number and the new Serial Number of the Printer. Use the **Up** and **Down** keys to go through the digits and press the **Enter** key to go to the next digit. You can press the **Cancel** key at any time to exit the utility without making any changes.

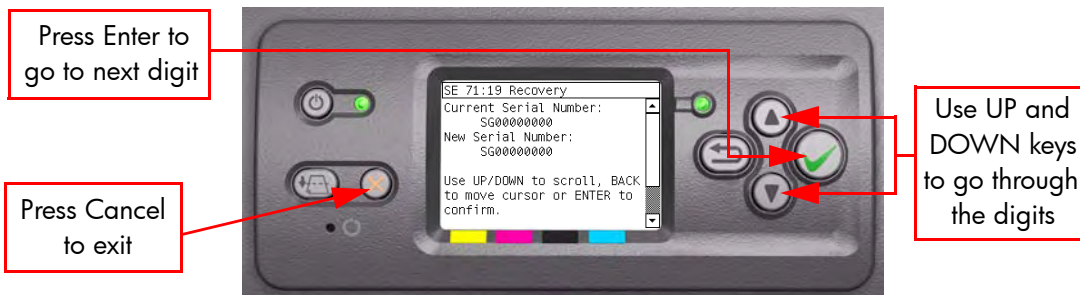

- 5 Once the new Serial Number has been entered, the Front Panel will display the Serial Number and Model Number of the Printer. Press the **Enter** key to confirm the Serial Number or the **Cancel** key to exit the utility without making any changes.

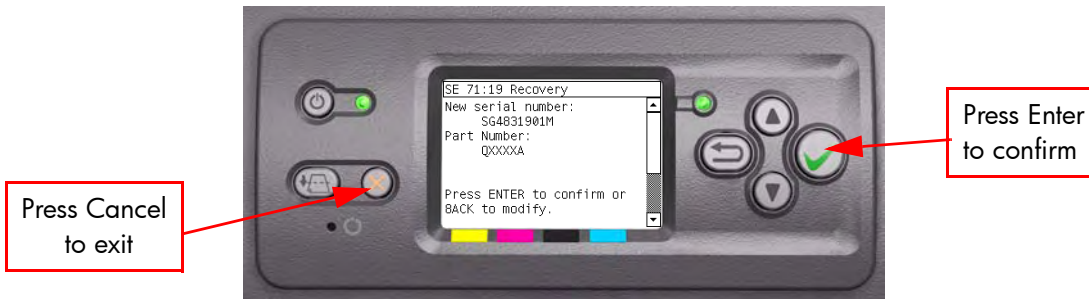

If there is a failure at this point, the Front Panel will display **System Error Code 79:03**. For more information on troubleshooting this error code, refer to Page 2-27.

- 6 A message will appear on the Front Panel asking you if you would like to change the Part Number of the Printer. Select **Yes** or **No** by using the **Up** and **Down** keys and press **Enter** to confirm your selection. If you select **No**, the process will end at this point.

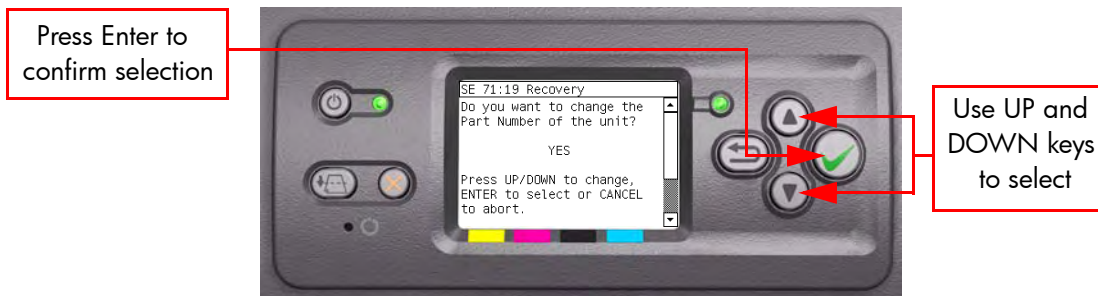

- 7 If you select **Yes**, the Front Panel will display the new Serial Number and Part Number. Press the **Enter** key to accept.

If there is a failure at this point, the Front Panel will display **System Error Code 79:03**. For more information on troubleshooting this error code, refer to Page 2-27.

- 8 Once the process is completed, OK will be displayed on the Front Panel.

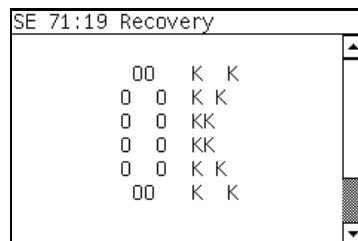

**Once the Printer has recovered from the System Error Code 71:19, the Printer will be configured as HP Designjet 4000 (part number Q1273A). If the Printer was originally a HP Designjet 4000ps (part number Q1274A), you must contact the HP Customer Support Center for further information.**

**PHONE SUPPORT**

### I/O Tests

The purpose of this test is to check the installed and active I/O Interfaces. Perform the I/O tests as follows:

- 1 Once the message "Ready" is displayed on the front-panel, scroll to the "Printer Setup Options" icon and press the **Enter** key.



- 2 Once inside the "Printer Setup Menus" menu, press the **UP or Down** arrow key and the **Cancel** key together. You are now in the **Service Tools** Menu.



- 3 Use the **Arrow** keys to scroll to the "Service Tests" menu and press the **Enter** key.



- 4 In the Service Tests submenu, scroll to "I/O Tests" and press **Enter**.



- 5** When the following message appears on the front panel, you must select whether you would like to continue with the test by pressing the **Enter** key. Press **Back** or **Cancel** to exit the calibration.

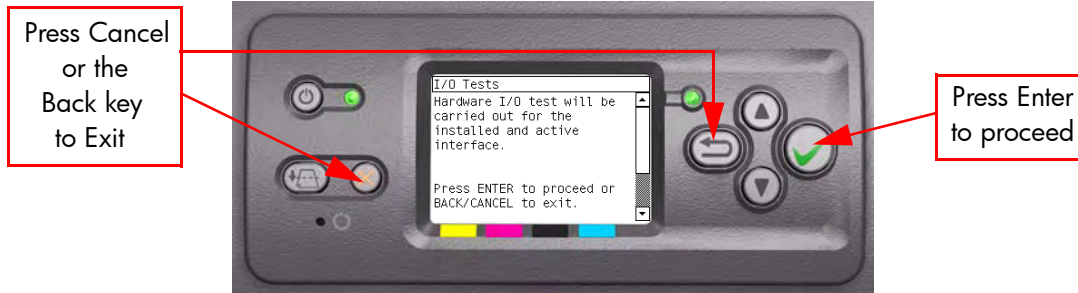

- 6** The Printer will get information on the I/O Interfaces. Once the information has been read, the following message will be displayed on the Front Panel. Press any key to continue with the test:

```

I/O Tests
Interface select.: AUTO
Active interface: FAST_ETH
Active int. installed: YES
Active int. MAC state: UP

Press any key to continue.

```

This screens shows which interface is currently installed and active. If a connection is made to the active interface, the "Active int. MAC state" will be displayed as UP, otherwise it will displayed as DOWN.

- 7** If an active interface is installed, the Printer will test the active interface and if it passes it will display the following message on the Front Panel:

```

I/O Tests
I/O test for 'FAST_ETH'
interface has passed.

```

- 8** Once the process is completed, OK will be displayed on the Front Panel.

## Service Utilities

The following is a list of all internal Service Utilities available in the Printers. Instructions for entering the Service Utilities menu are given on Page 4-52.

**1** Turn Drive Roller ⇒ Page 4-54

The purpose of this Service Utility is to rotate the Drive Roller and the Overdrive in order to clean them.

**2** Prime Tubes ⇒ Page 4-56

The purpose of this Service Utility is to Prime the Tubes when the Ink Tubes are NOT new and they need to be re-primed or automatic priming was not completed correctly.

**3** Set SN ⇒ Page 4-60

The purpose of this Service Utility is to set the Serial Number of the Printer.

**4** Reset Life Counters ⇒ Page 4-61

The purpose of this Service Utility is to reset the internal life counters. There are two submenus that allow you to:

- Reset ALL the counters related to a Preventive Maintenance Kit (PMK).
- Reset only the counters related to a specific replaced part.

**5** Diagnostic Print ⇒ Page 4-63

The purpose of this Service Utility is to print the Diagnostic Print in order to identify image quality problems.

**6** Sleep Mode ⇒ Page 4-64

The purpose of this Service Utility is to enable/disable the sleep mode so that the Printer is never switched Off automatically if not used for a certain period of time (one hour by default).

**7** Replace Cutter ⇒ Page 4-65

The purpose of this Service Utility is to move the Carriage to a position where the Cutter can be replaced easily.

**8** Set RTC Clock ⇒ Page 4-66

The purpose of this Service Utility is to set the Real Time Clock (RTC) of the Printer.

**9** Carriage Setup ⇒ Page 4-67

The purpose of this Service Utility is to reset the ink short thresholds after replacing the Carriage PCA.

## Entering the Service Utilities Menu

- 1 Once the message "Ready" is displayed on the front-panel, scroll to the "Printer Setup Options" icon and press the **Enter** key.

Press Enter to confirm selection

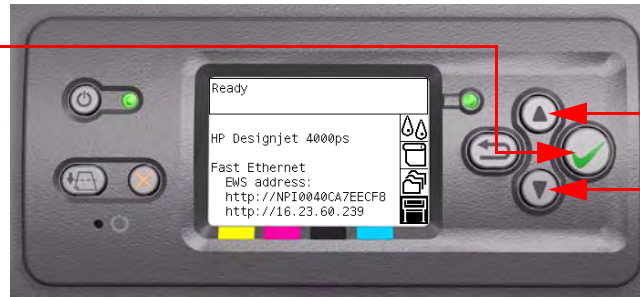

Use UP and DOWN keys to select

- 2 For Call Agents who will request the user to perform certain Service Utilities, once inside the "Printer Setup" menu, press the **Down** arrow key and the **Cancel** key together. You are now in the **Service Tools** Menu.

**PHONE SUPPORT**

Press Cancel key

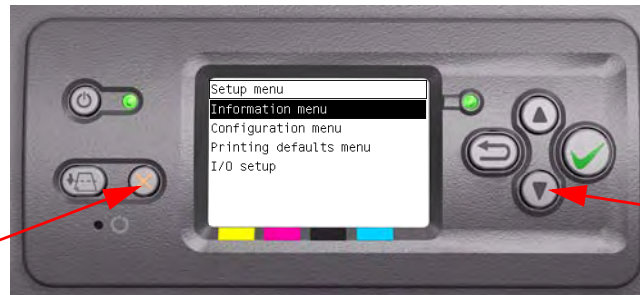

Press DOWN key

- 3 For On-Site Engineers, once inside the "Printer Setup" menu, press the **Up** arrow key and the **Cancel** key together. You are now in the **Service Tools** Menu.

**ON-SITE REPAIR**

Press Cancel key

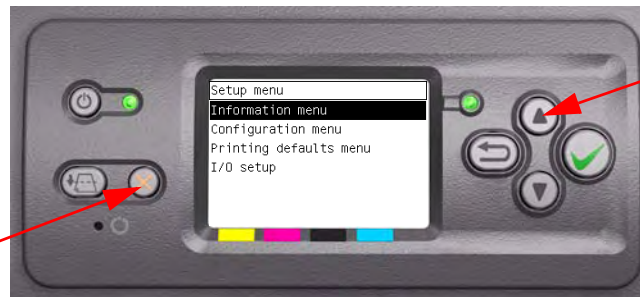

Press UP key

- 4** Use the **Arrow** keys to scroll to the "Service Utilities" menu and press the **Enter** key.



- 5** Use the **Arrow** keys to scroll through the "Service Utilities" selections and press the **Enter** key to begin a specific operation when the required Service Utility is highlighted.

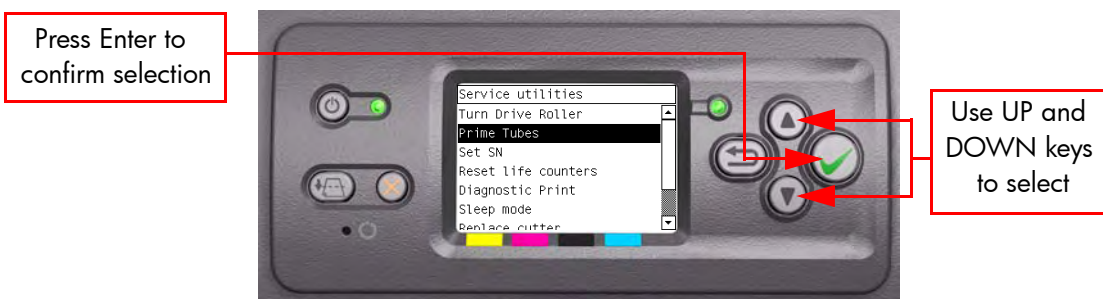

**If the printer is not used for 135 seconds, the printer exits out of the Service Utilities Menu and you must repeat the above steps to enter Service Utilities again.**

**In some cases a quick press of a button may not be recognized by the Printer. When pressing a button, be sure to press it deliberately and all the way to the bottom of its travel.**

**PHONE SUPPORT**

## 1. Turn Drive Roller

The purpose of this Service Utility is to rotate the Drive Roller and the Overdrive in order to clean them.

**REMOVE THE MEDIA BEFORE PERFORMING THIS OPERATION.**

**OPEN THE WINDOW OF THE PRINTER AND ACTIVATE THE WINDOW SENSOR (USING A PIECE OF PAPER) BEFORE PERFORMING THIS SERVICE UTILITY.**

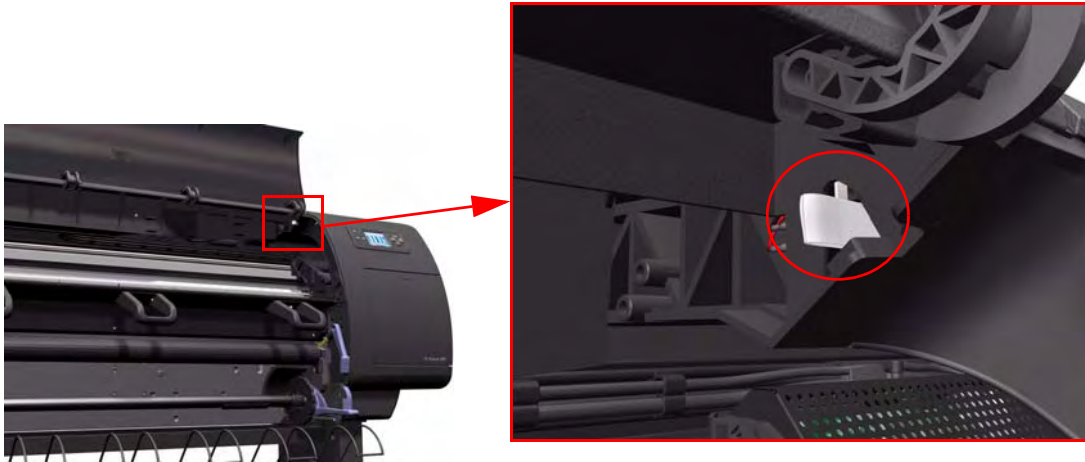

Perform the Turn Drive Roller utility as follows:

- 1 In the Service Utilities submenu, scroll to "Turn Drive Roller" and press **Enter**.



- 2 The Printer checks to see if media is loaded. If media is loaded, the Front Panel will display the following message. Unload the media and start again from **step 1**:

```

Turn Drive Roller
Paper detected.
Please, remove media
completely and start again.
  
```



- 3 The Drive Roller begins to turn slowly and the following message is displayed on the Front Panel:

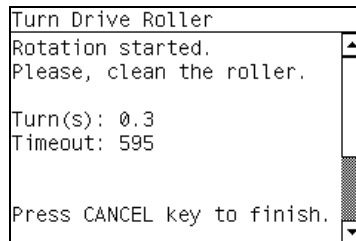

- 4 Refer to the Cleaning Instructions on Page 9-3.
- 5 Once you have finished cleaning the Drive Roller and the Overdrive, press the **Cancel** key to finish the utility.
- 6 If the utility exits correctly, OK will be displayed on the Front Panel.

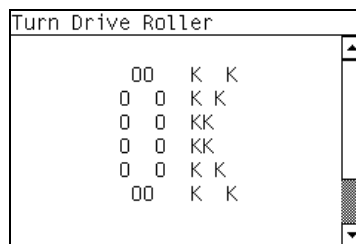

**PLEASE REMEMBER TO REMOVE THE PIECE OF PAPER FROM THE WINDOW SENSOR BEFORE CLOSING THE WINDOW AS THIS COULD DAMAGE THE WINDOW AND THE SENSOR.**

## 2. Prime Tubes

The purpose of this Service Utility is to Prime the Tubes when the Ink Tubes are NOT new and they need to be re-primed or automatic priming was not completed correctly.

**Make sure that NEW Ink Cartridges are installed or that the ink volume remaining in the Ink cartridges is below 88% before starting to prime the tubes. If you do not comply, you will get a warning message.**

Perform the Prime Tubes utility as follows:

- 1 In the Service Utilities submenu, scroll to "Prime Tubes" and press **Enter**.



- 2 If the Ink Cartridges are not suitable for priming, the following message will appear on the Front Panel. Replace the installed Ink Cartridges with Ink Cartridges that are new or contain less than 88% of ink. Press any key to finish the utility.

```
Prime Tubes
Some of the current ink
supplies are not valid for
purge (0 1 2 3). Please,
replace them by valid
cartridges for purge and
start again.

Press any key to finish.
```

- 3 When the following message appears on the front panel, you must select whether you would like to continue with the procedure by pressing the **Enter** key, in which case the Printer will reboot. Press **Back** or **Cancel** to exit the procedure at this point.

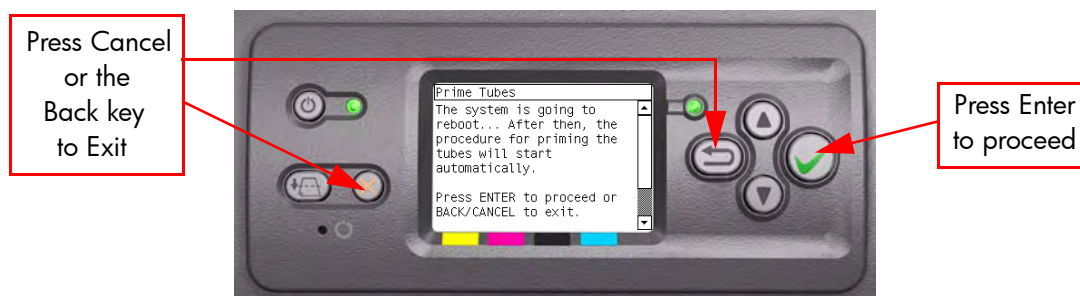

- 4** Once the Printer has rebooted, the Front Panel will instruct you to open the Window and remove ALL the Printheads installed in the Carriage.

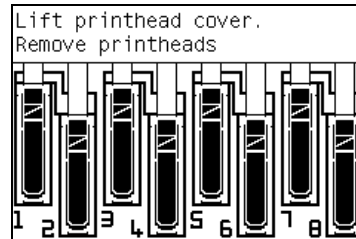

- 5** Once ALL the Printheads have been removed, the Front Panel will instruct you to install the Setup Printheads into the Carriage. Make sure you install the Setup Printheads in stalls 1, 3, 5 and 7.

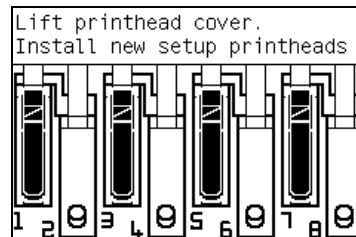

- 6** Once all the Setup Printheads are installed, the following message will appear on the front panel. Close the carriage cover and close the window.

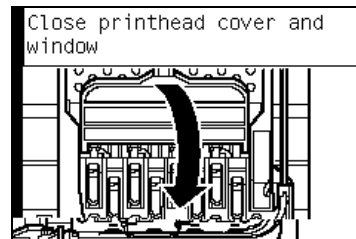

- 7** The printer will begin to purge the tubes system.
- 8** Once the tubes system has been purged, the following message will instruct you to open the Window:

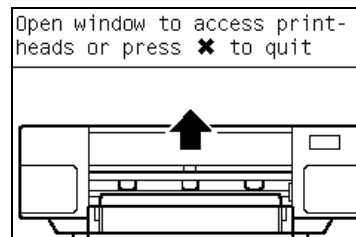

- 9 When the following message appears on the Front Panel, open the Carriage cover and check the window on top of each Setup Printhead. If the Ink Supply Tubes have been primed correctly, the windows will contain ink. If the windows on top of each Setup Printhead does NOT contain ink, then you may need to repeat the Prime Tubes process from the beginning.

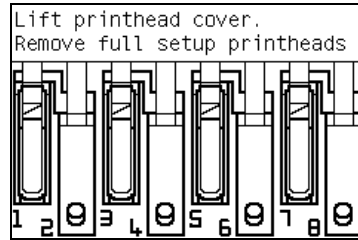

- 10 Remove ALL the Setup Printheads from the Carriage and install the previously removed Printheads.
- 11 Once ALL the Printheads are installed, the Front Panel will instruct you to close the Carriage cover and close the Window.

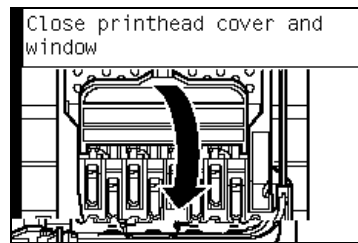

- 12 Open the right cover and make sure the Printhead Cleaners are installed in the Service Station.

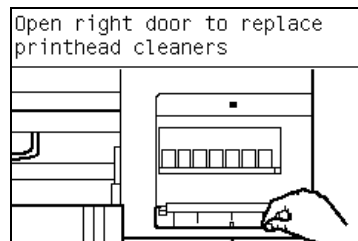

- 13 The Printer will now perform the Printhead Alignment and the following message will be displayed on the Front Panel. To continue with the Printhead Alignment, select "Align now" and press the **Enter** key.

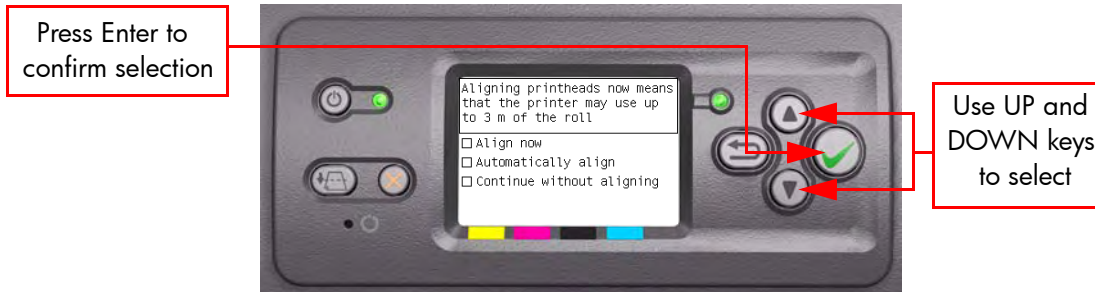

- 14** Once the Printhead Alignment is completed, the following message will be displayed on the Front Panel. Press the **Enter** key to continue.

```
Printhead alignment
Calibration successfully
completed.
Press ✓ to continue
```

### 3. Set SN

The purpose of this Service Utility is to set the Serial Number of the Printer. Perform the Set SN utility as follows:

- 1 In the Service Utilities submenu, scroll to "Set SN" and press **Enter**.

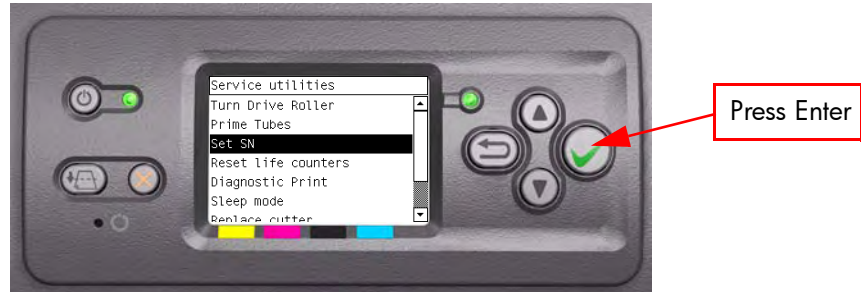

- 2 The Printer will display the current Serial Number and the new Serial Number of the Printer. Use the **Up** and **Down** keys to go through the digits and press the **Enter** key to go to the next digit. You can press the **Cancel** key at any time to exit the utility without making any changes.

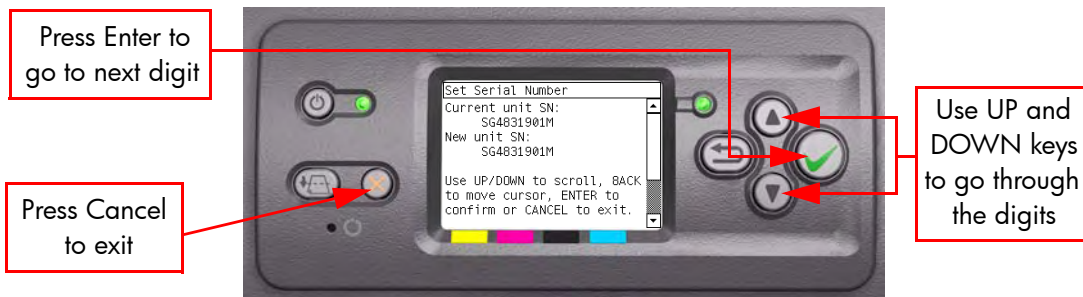

If the Serial Number or the Part Number cannot be read, the Front Panel will display **System Error Code 74:00**. For more information on troubleshooting this error code, refer to Page 2-20.

- 3 Once the new Serial Number has been entered, the Front Panel will display the Serial Number and Model Number of the Printer. Press the **Enter** key to confirm the Serial Number or the **Cancel** key to exit the utility without making any changes or the **Back** key to modify again.

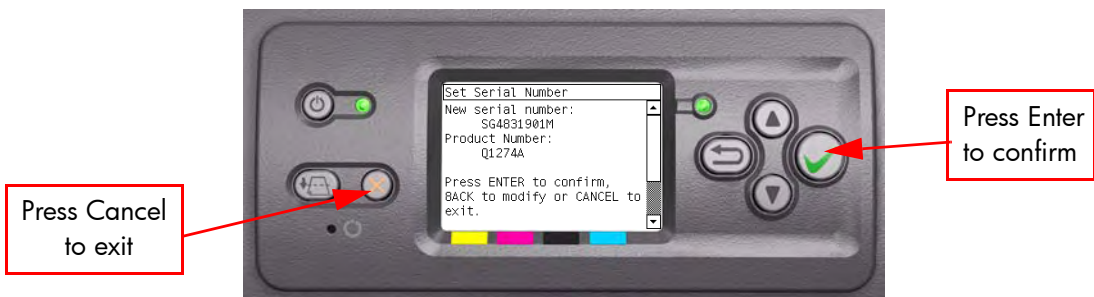

- 4 If the new Serial Number cannot be set, the Front Panel will display **System Error Code 74:00**. For more information on troubleshooting this error code, refer to Page 2-20.
- 5 If the utility exits correctly, OK will be displayed on the Front Panel.

## 4. Reset Life Counters

The purpose of this Service Utility is to reset the internal life counters. There are two submenus that allow you to:

- Reset ALL the counters related to a Preventive Maintenance Kit (PMK).
- Reset only the counters related to a specific replaced part.

**ALWAYS RESET THE LIFE COUNTER OF A CORRESPONDING PART AFTER REPLACING IT.**

Perform the Reset Life Counters utility as follows:

- 1 In the Service Utilities submenu, scroll to "Reset Life Counters" and press **Enter**.

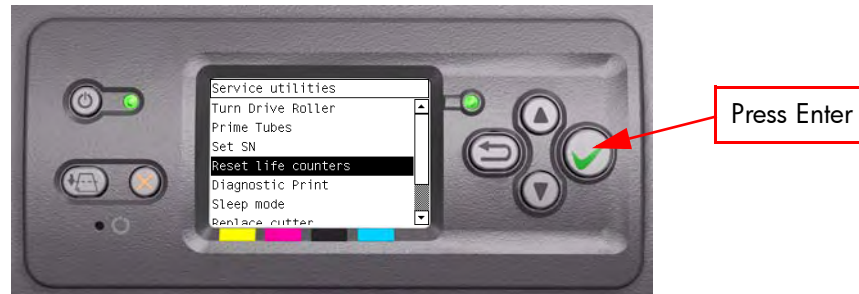

- 2 You will be given an option to either reset the Life Counter for ALL the parts related to a Preventive Maintenance Kit (PMK) or to just reset the Life Counter for a particular part:

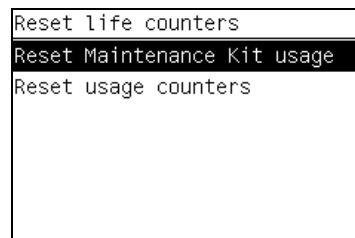

- a If you select to reset the Life Counter for ALL the parts related to a Preventive Maintenance Kit (PMK), you will be given an option to reset the Life Counter of:
  - Preventive Maintenance Kit 1 (PMK1).
  - Preventive Maintenance Kit 2 (PMK2).
- b If you select to reset the Life Counter for a particular part, you will be given an option to reset the Life Counter of the:
  - Scan-Axis Motor.
  - Trailing Cable and Tubes.
  - Carriage Belt.
  - Carriage (Bushing).
  - Most Left Spittoon.
  - Middle Left Spittoon.
  - PHC Spittoons.

- 3 Once you have selected a Life Counter to reset, the following message will be displayed on the Front Panel. Press the **Enter** key to reset the selected Life Counter or press **Back/Cancel** to exit without resetting the Life Counter.

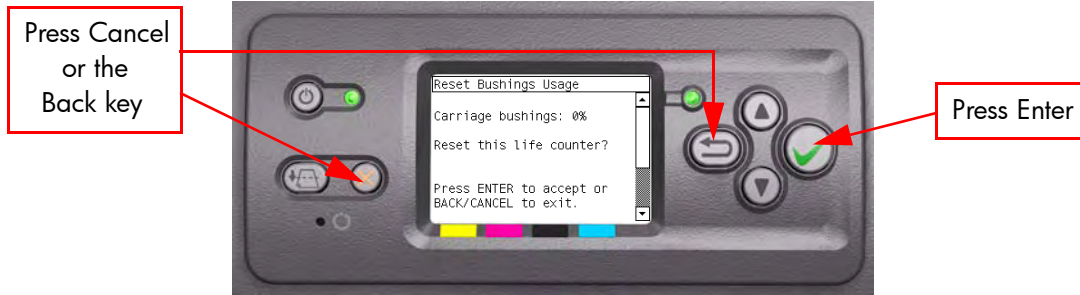

If the Usage Counter information cannot be read, the Front Panel will display "Unable to get usage counter". This could point to a possible Firmware error.

- 4 If the utility exits correctly, OK will be displayed on the Front Panel.

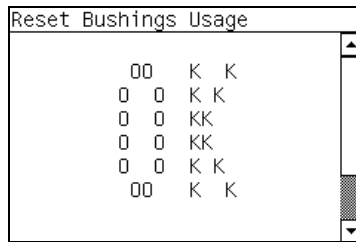



**PHONE SUPPORT**

## 5. Diagnostic Print

The purpose of this Service Utility is to print the Diagnostic Print in order to identify image quality problems.

Print the Diagnostic Print as follows:

- 1 In the Service Utilities submenu, scroll to "Diagnostic Print" and press **Enter**.



- 2 You will be given an option to either print the "Image Quality User Plot" or the "Image Quality Service Plot". Use the **Arrow** keys to make the selection and press the **Enter** key to start printing the required Diagnostic Print.



- 3 Make sure media is loaded, the Pinch Lever is lowered and that the Ink System is correctly installed. Press the **Enter** key to print the Diagnostic Print or press **Back/Cancel** to exit without printing the Diagnostic Print.

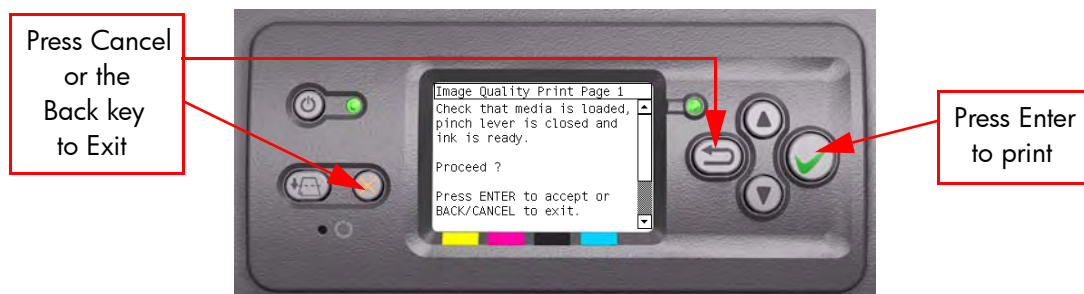

- 4 The selected Diagnostic Print will now be printed. For further information on how to use troubleshoot Image Quality problems, refer to Chapter 6.

**PHONE SUPPORT**

## 6. Sleep Mode

The purpose of this Service Utility is to enable/disable the sleep mode so that the Printer is never switched Off automatically if not used for a certain period of time (one hour by default).

Perform the Sleep Mode utility as follows:

- 1 In the Service Utilities submenu, scroll to "Sleep Mode" and press **Enter**.



- 2 When the following message appears on the front panel, use the **Up** and **Down** arrow keys to either disable or enable the sleep mode. Press the **Enter** or **Cancel** key to confirm the selection.



If the current sleep mode cannot be read, it could point to a possible Firmware error.

- 3 Once the selection is confirmed, the Front Panel will display the new sleep mode state:

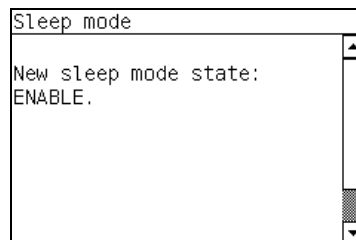

If the current sleep mode cannot be set, it could point to a possible Firmware error.

- 4 If the utility exits correctly, OK will be displayed on the Front Panel.

**PHONE SUPPORT**

## 7. Replace Cutter

The purpose of this Service Utility is to move the Carriage to a position where the Cutter can be replaced easily.

Perform the Replace Cutter utility as follows:

- 1 In the Service Utilities submenu, scroll to "Replace Cutter" and press **Enter**.

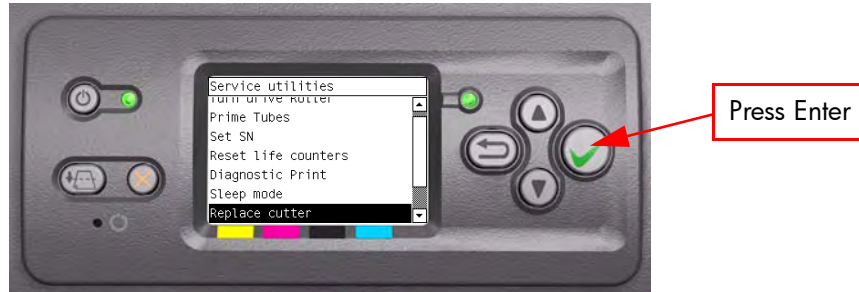

- 2 When the following message appears on the front panel, you must select whether you would like to continue with replacing the Cutter by pressing the **Enter** key. Press **Back** or **Cancel** to exit the utility.

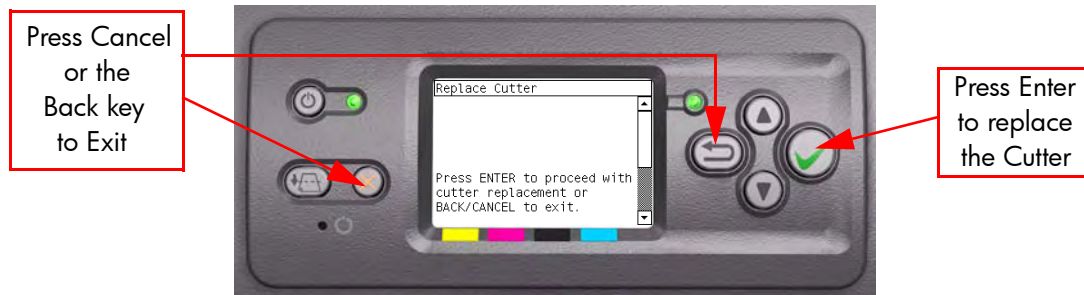

- 3 The Carriage will move to the Cutter replacement position and the following message will be displayed on the Front Panel. After a few seconds the Printer will begin to shutdown.

```

Replace Cutter
The system is shutting
down... After then, switch
off the printer with the
back switch. Then replace
the cutter and switch on
the unit again.
    
```

- 4 Before replacing the Cutter, make sure that you switch the Printer OFF from the rear.

**PHONE SUPPORT**

## 8. Set RTC Clock

The purpose of this Service Utility is to set the Real Time Clock of the Printer.

Perform the Set RTC Clock utility as follows:

- 1 In the Service Utilities submenu, scroll to "Set RTC Clock" and press **Enter**.

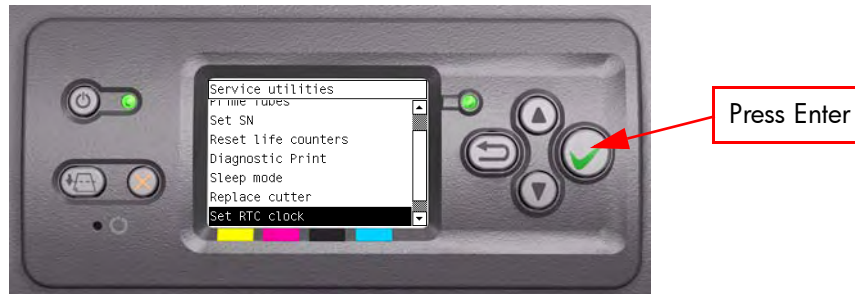

- 2 The Printer will display the current time and the new time. Use the **Up** and **Down** keys to go through the digits and press the **Enter** key to go to the next digit. You can press the **Cancel** key at any time to exit the utility without making any changes.

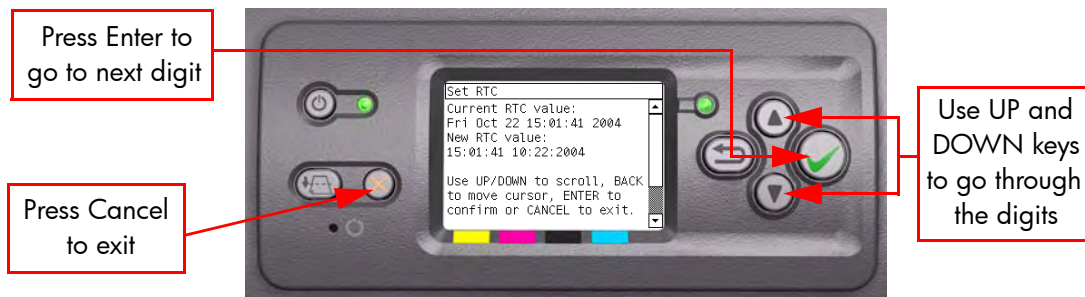

- 3 Once the new time has been entered, the Front Panel will display the time that you have requested. Press the **Enter** key to confirm the time or the **Cancel** key to exit the utility without making any changes or the **Back** key to modify again.

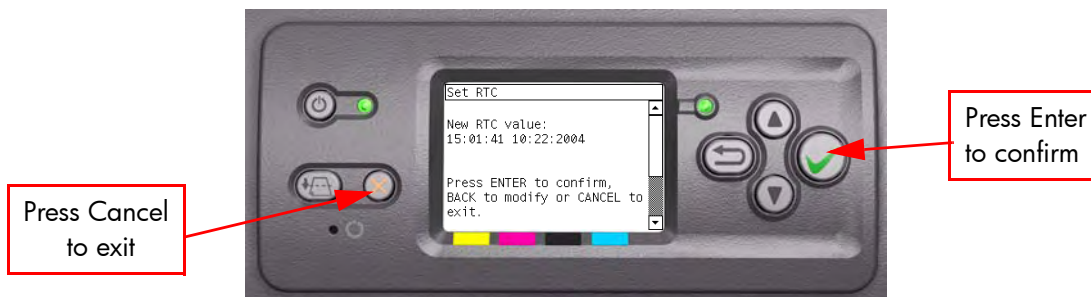

If the current RTC Clock cannot be set, it could point to a possible Firmware error.

- 4 If the utility exits correctly, OK will be displayed on the Front Panel.

**PHONE SUPPORT**

## 9. Carriage Setup

The purpose of this Service Utility is to reset the ink short thresholds after replacing the Carriage PCA.

**From Firmware Version 4.x.x.x, "Carriage Setup" will be moved from Service Utilities to the Service Calibrations section.**

Perform the Carriage Setup utility as follows:

- 1 In the Service Utilities submenu, scroll to "Carriage Setup" and press **Enter**.



- 2 When the following message appears on the front panel, you must select whether you would like to continue with the Carriage Setup by pressing **Enter**. Press **Back** or **Cancel** to exit the utility.

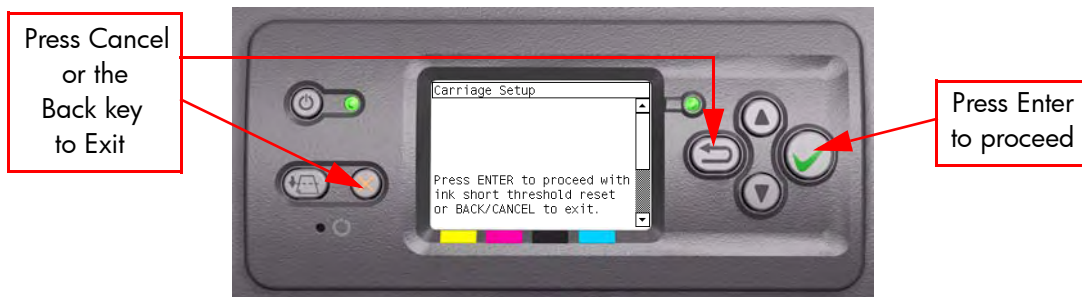

- 3 If the Ink Short Thresholds have been reset correctly, the following message will be displayed on the Front Panel. Press any key to exit:

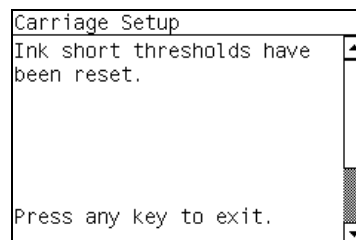

If any of the Printhead ink short thresholds cannot be reset or if the Printheads info cannot be accessed, it could point to a possible Firmware error.

- 4 If the utility exits correctly, OK will be displayed on the Front Panel.



# Service Calibrations

# 5

## Service Calibrations 5-2

### Entering the Service Calibrations Menu 5-3

1. Scan Axis Calibration 5-4
2. Service Station Calibration 5-8
3. Paper Advance Calibration 5-9
4. Drop Detector Calibration 5-15
5. Line Sensor Calibration 5-16
6. Platen Blue Line Calibration 5-20
7. Vacuum Calibration 5-22
8. Carriage Setup 5-23

## Service Calibrations

The Printer has several calibration procedures that must be performed under certain conditions.

**REMEMBER THAT CERTAIN CALIBRATIONS ARE REQUIRED EVEN IF AN ASSEMBLY HAS BEEN DISASSEMBLED TO GAIN ACCESS TO ANOTHER ASSEMBLY OR COMPONENT.**

The following is a list of all internal service calibrations available in the Printers. Instructions for entering the service calibrations menu are given on Page 5-3.

- 1** Scan Axis Calibration ⇒ Page 5-4  
The purpose of this Service Calibration is to carry out a PWM check, and calibrate the intensity of the Line Sensor.
- 2** Service Station Calibration ⇒ Page 5-8  
The purpose of this Service Calibration is to calibrate the Drop Detector (located in the Service Station) in relation to the Carriage Assembly.
- 3** Paper Advance Calibration ⇒ Page 5-9  
The purpose of this Service Calibration is to calibrate the nominal advance of the media. This calibration is necessary to control the exact movement of the media in order to avoid print quality problems like banding.
- 4** Drop Detector Calibration ⇒ Page 5-15  
The purpose of this Service Calibration is to calibrate the Drop Detector (located in the Service Station) in relation to the Carriage Assembly.
- 5** Line Sensor Calibration ⇒ Page 5-16  
The purpose of this Service Calibration is to calibrate the intensity of the Line Sensor. An incorrect calibration can result in edge-detection failures during media loading and incorrect reading of prints that are used for alignment or calibration.
- 6** Platen Blue Line Calibration ⇒ Page 5-20  
The purpose of this Service Calibration is to calibrate the blue line which is marked on the Print Platen.
- 7** Vacuum Calibration ⇒ Page 5-22  
The purpose of this Service Calibration is to set the default nominal and real values of the Vacuum Fan.
- 8** Vacuum Calibration ⇒ Page 5-22  
The purpose of this Service Calibration is to reset the ink short thresholds after replacing the Carriage PCA.

**If ALL the Calibrations need to be performed (for example, when both the HDD and the ISS PCA have been replaced), you must perform them in the following order:**

- **Vacuum Calibration.**
- **Drop Detector/Service Station Calibration.**
- **Line Sensor/Scan Axis Calibration.**
- **Paper Advance Calibration.**
- **Platen Blue Line Calibration.**



## Entering the Service Calibrations Menu

- 1 Once the message "Ready" is displayed on the front-panel, scroll to the "Printer Setup Options" icon and press the **Enter** key.



- 2 Once inside the "Printer Setup Menus" menu, press the **UP or Down** arrow key and the **Cancel** key together. You are now in the **Service Tools** Menu.



- 3 Use the **Arrow** keys to scroll to the "Service Calibrations" menu and press the **Enter** key.

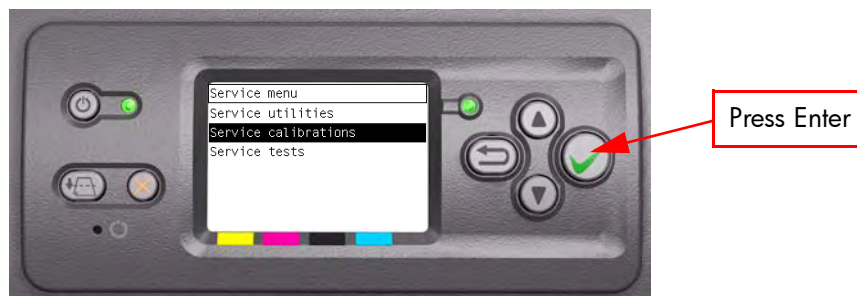

- 4 Use the **Arrow** keys to scroll through the "Service Calibrations" selections and press the **Enter** key to begin a specific operation when the required Service Calibration is highlighted.

**If the printer is not used for 135 seconds, the printer exits out of the Service Calibrations Menu and you must repeat the above steps to enter Service Calibrations again.**

## 1. Scan Axis Calibration

The purpose of this Service Calibration is to carry out a PWM check, calibrate the intensity of the Line Sensor and calibrate the Line Sensor position to the Black Printhead.

Perform the Scan Axis Calibration whenever:

- Carriage is disassembled or replaced.
- Encoder Strip is disassembled or replaced.
- Center Platen is disassembled or replaced.

Perform the Scan Axis Calibration as follows:

**Make sure you load one of the following media into the Printer before performing this calibration:**

- **HP Bond Paper.**
- **HP Glossy Media.**
- **HP Coated Paper.**
- **HP Productivity Photo Gloss.**
- **HP Heavyweight Coated Paper.**
- **HP Super Heavyweight Coated Paper.**
- **HP Bright White Inkjet Paper.**

- 1 In the Service Calibrations submenu, scroll to "Scan Axis Calibration" and press **Enter**.

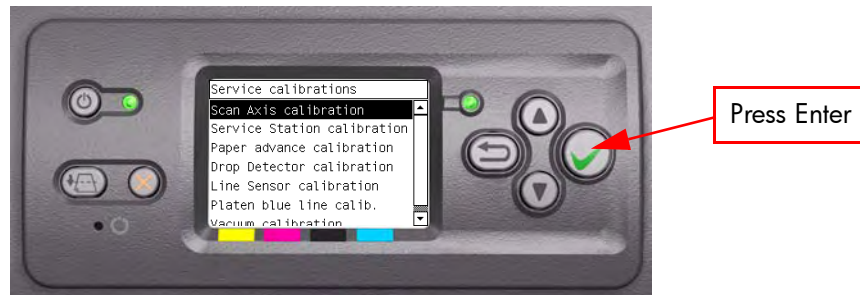

- 2 When the following message appears on the front panel, you must select whether you would like to continue with the calibration by pressing the **Enter** key. Press **Back** or **Cancel** to exit the calibration.

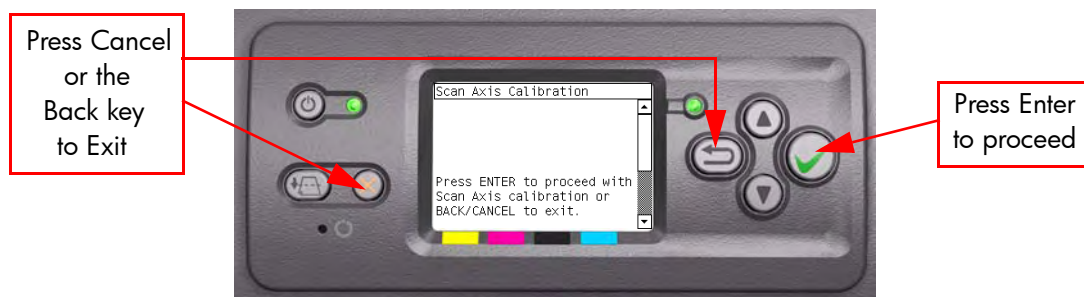

- 3** If media is not loaded, the following message appears on the front panel. Load media in to the Printer and start again from **step 1**.

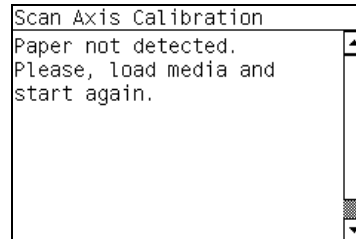

Before continuing, the Printer will check the following:

- The Media Lever is in the lowered position.
- The correct paper type is loaded (check list on previous page).
- The correct paper size (minimum paper size 24 inches).

If these conditions are **not** met, a warning will be displayed on the Front Panel and you will need to restart the Calibration from **step 1**.

**Make sure you keep your hands away from the Print Platen as the Carriage will be moving at high speed and you could injure yourself or damage the Carriage Assembly.**

- 4** The Printer will start to check the PWM. Once the PWM has been checked, the results will be displayed on the Front Panel. Press **Enter** to continue or press **Back** or **Cancel** to exit the calibration.

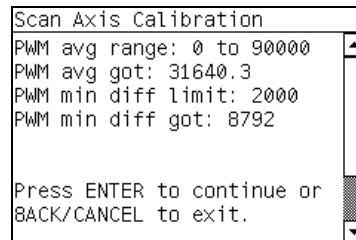

- 5** The Printer will start to calibrate the Line Sensor. Once the Line Sensor has been calibrated, the results will be displayed on the Front Panel. Press Enter to continue or press **Back** or **Cancel** to exit the calibration.

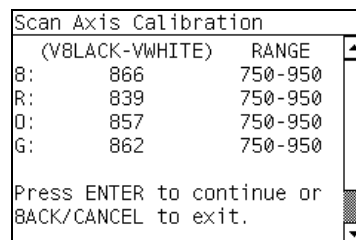

If the values are not within the range specified, an error will appear on the Front Panel. In this case, try the following:

- Try the Scan-Axis Calibration again.
- Replace the Line Sensor ⇒ Page 8-37.

- 6 The Printer will start to calibrate the Line Sensor position to the Black Printhead. It will print a line of black dots and then scan them:

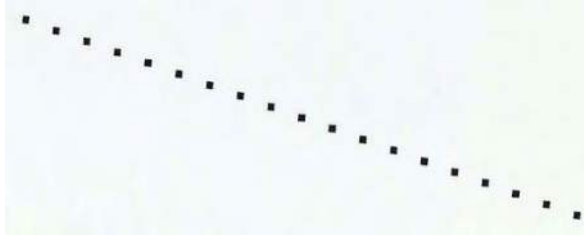

- 7 Once the Line Sensor has been calibrated, the results will be displayed on the Front Panel. Press **Enter** to finish the calibration or press **Back** or **Cancel** to exit the calibration.

```

Scan Axis Calibration
Y Offset Range: 30 to 59
Y Offset got: 43
X Offset Range: -24 to 24
X Offset got: 14
X SVS Offset: -1050 to 1050
X SVS Offset got: -944
Press any key to continue.

```

- 8 The Printer will now perform the Printhead Alignment. When the following message appears on the front panel, you must select whether you would like to continue with the calibration by pressing the **Enter** key. Press **Back** or **Cancel** to exit the calibration.

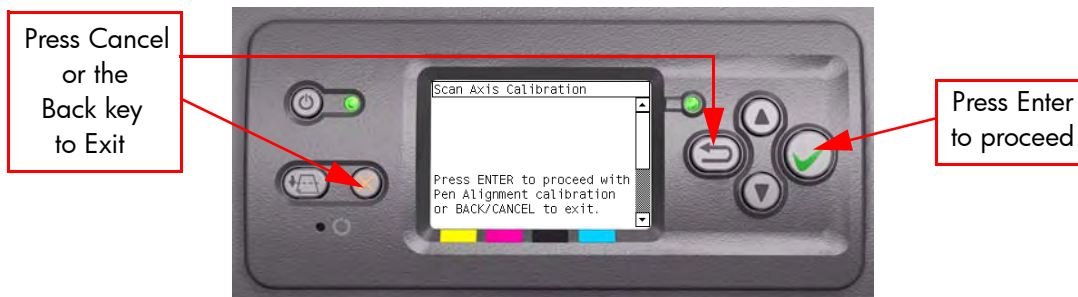

- 9 Before continuing with the Printhead Alignment, the following message will be displayed on the Front Panel. To continue with the Printhead Alignment, select "Align now" and press the **Enter** key.

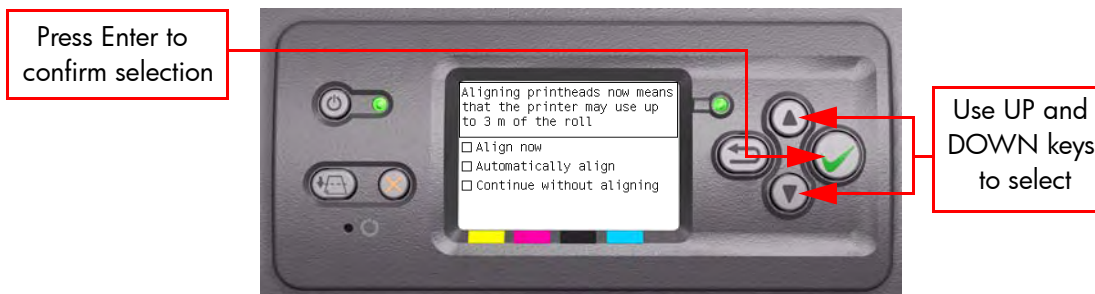

- 10** Once the Printhead Alignment is completed, the following message will be displayed on the Front Panel. Press the **Enter** key to continue.

```
Printhead alignment
Calibration successfully
completed.
Press ✓ to continue
```

If the Printhead Alignment fails for any reason, a warning message will appear on the Front Panel. In this case, try the following:

- Enter the Front Panel menu and retry the Printhead Alignment. If the Alignment completes successfully, then perform the Color Calibration.
  - If the Alignment fails again, check the Alignment pattern to see if any of the Printheads are printing incorrectly. If necessary, perform a Printhead Recovery through the Front Panel and retry the Printhead Alignment.
- 11** The Printer will now perform the Color Calibration. When the following message appears on the front panel, you must select whether you would like to continue with the calibration by pressing the **Enter** key. Press **Back** or **Cancel** to exit the calibration.

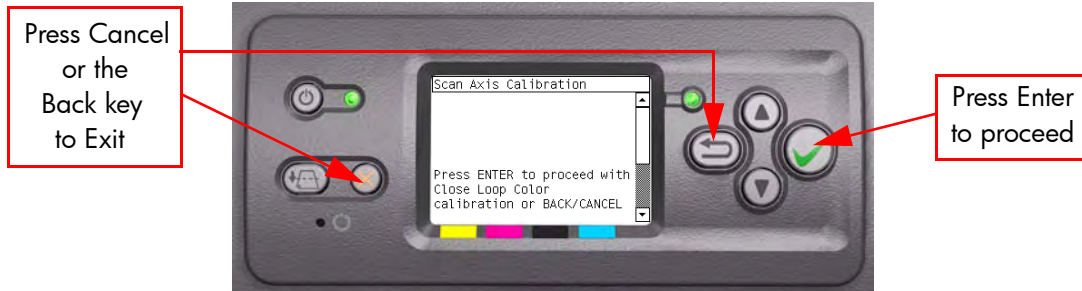

- 12** Once the Color Calibration is completed, the following message will be displayed on the Front Panel. Press the **Enter** key to continue.

```
Color calibration
Calibration successfully
completed.
Press ✓ to continue
```

All CLC profiles are deleted so you will need to perform Color Calibration again for every new media that is loaded in to the Printer.

If the Color Calibration fails for any reason, a warning message will appear on the Front Panel. In this case, try the following:

- Enter the Front Panel menu and retry the Color calibration.
  - If the Calibration fails again, check the Calibration pattern to see if any of the Printheads are printing incorrectly. If necessary, perform a Printhead Recovery through the Front Panel and retry the Calibration.
- 13** Once the complete Scan Axis calibration is completed successfully, OK will be displayed on the Front Panel.

## 2. Service Station Calibration

The purpose of this Service Calibration is to calibrate the Service Station in relation to the Carriage Assembly.

Perform the Service Station Calibration whenever:

- Carriage Assembly is disassembled or replaced.
- Service Station is disassembled or replaced.

Perform the Service Station Calibration as follows:

- 1 In the Service Calibrations submenu, scroll to "Service Station Calibration" and press **Enter**.

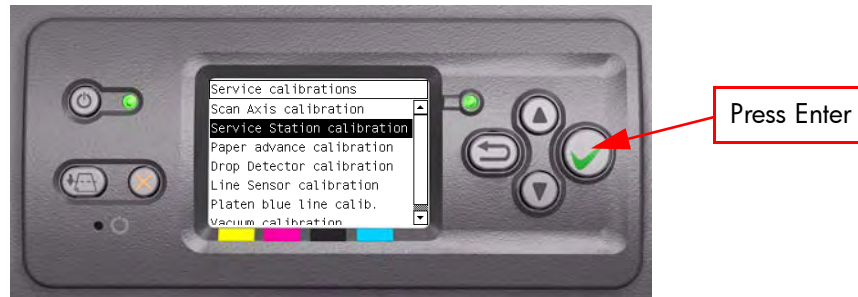

- 2 When the following message appears on the front panel, you must select whether you would like to continue with the calibration by pressing the **Enter** key. Press **Back** or **Cancel** to exit the calibration.

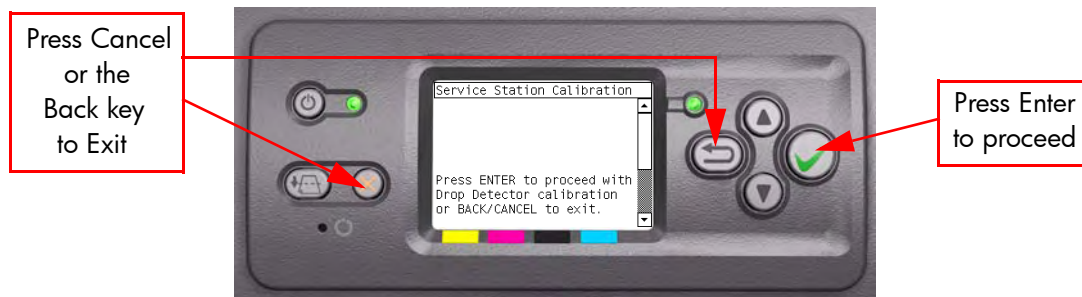

- 3 The Printer will start to calibrate the Service Station. Once the Service Station has been calibrated, the results will be displayed on the Front Panel. Press any key on the Front Panel to finish the calibration.

```

Service Station Calibration
-----
DD Offset Range: -90 to 90
DD Offset got: 10
Min window width: 4
Window width got: -1

Press any key to exit.
  
```

- 4 Once the calibration is completed, OK will be displayed on the Front Panel.

**This Calibration will be available from FW Version 3.x.x.x**

### 3. Paper Advance Calibration

The purpose of this Service Calibration is to calibrate the nominal advance of the media. This calibration is necessary to control the exact movement of the media in order to avoid print quality problems like banding.

**In order to perform this Calibration, you should order the Paper Advance Calibration Kit (Part Number Q1273-60125) which contains two sheets of HP Productivity Gloss Media.**

Perform the Service Accuracy Calibration whenever:

- Banding is detected in prints.
- Drive Roller is disassembled or replaced.
- Paper-axis Assembly is disassembled or replaced.

The Paper Advance Calibration is split into three parts and should **always** be done in this order:

- 1 Print Calibration Pattern - The Printer first calibrates the Analog Encoder and then prints the Paper Advance Calibration pattern.
- 2 Scan Calibration Pattern - The Printer scans the Paper Advance Calibration pattern in order to calibrate the nominal advance of the media.

**Only scan the Calibration Pattern in the Printer that was used to actually print it. Using the Calibration in a different Printer could cause it to experience media advance problems. After scanning the Calibration Pattern, it should be discarded.**

- 3 Clean Drive Roller - After loading media that the customer will use, the Printer "prepares" the media path to prevent any future advance problems.

Perform the Paper Advance Calibration as follows:

**Make sure that you unload media from the Printer before performing the Paper Advance Calibration.**

- 1 In the Service Calibrations submenu, scroll to "Paper Advance Calibration" and press **Enter**.

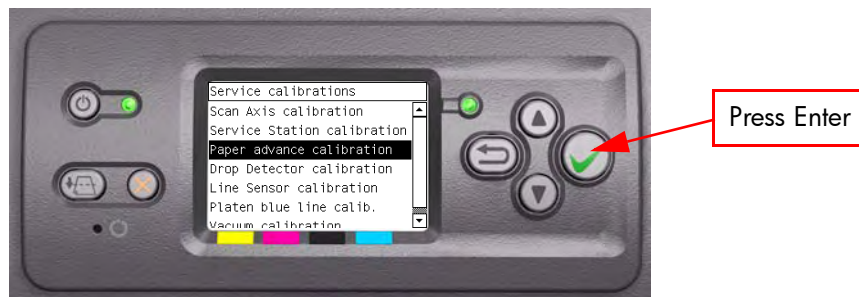

- 2** In the Paper Advance Calibration submenu, scroll to "Print Calibration Pattern" and press **Enter**.



- 3** When the following message appears on the front panel, you must select whether you would like to continue with the calibration by pressing the **Enter** key. Press **Back** or **Cancel** to exit the calibration.

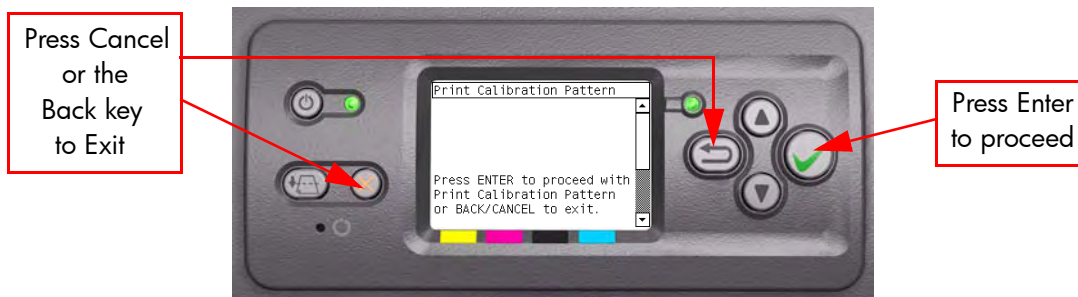

- 4** The Printer will start to calibrate the Analog Encoder and the following message will be displayed on the Front Panel.

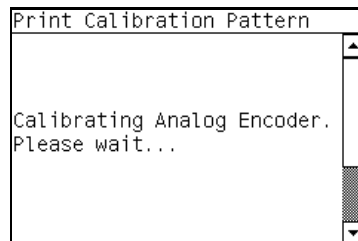

If the Calibration is not done or if the values are out of the limits, a warning message will appear on the Front Panel. In this case, try the following:

- Check that the Printer has the latest Firmware version. If not, update the Firmware to the latest version.
- Retry the Paper Advance Calibration.
- If the problem continues, replace the Encoder Strip and Encoder Sensor ⇒ Page 8-45.



- 5 Once the Analog Encoder has been calibrated correctly, the following message will appear on the Front Panel. Press the **Enter** key in order to start the media load process.

```
Print Calibration Pattern
Press ENTER to load paper.
```

- 6 Load a sheet of HP Productivity Gloss Media that was included in the Paper Advance Calibration Kit (Part Number Q1273-60125) following the instructions on the Front Panel. If the kit is not available, then cut a piece of HP Productivity Gloss Media that is 36 inches wide and at least 45 inches long.
- 7 Once the media is loaded into the Printer, the following message will appear on the Front Panel. If roll media has been used instead of cut sheet media, then you will need to unroll a minimum of 1 meter of media in order to prevent any back tension which could cause any media advance problems. Press the **Enter** key to continue.

```
Print Calibration Pattern
WARNING: If roll is used,
unroll 1 meter of media to
avoid back tension.

Press ENTER to proceed with
pattern printing.
```

- 8 The Printer will start to print the Paper Advance Calibration Pattern. This could take several minutes during which the following message will be displayed on the Front Panel.

```
Paper advance calibration
Printing pattern
```

- 9 Once the Accuracy Calibration Pattern has been printed successfully, the following message will be displayed on the Front panel. Press the **Enter** key to continue.

```
Paper advance calibration
Calibration successfully
completed.

Press ↵ to continue
```

If the Paper Advance Calibration fails for any reason, a warning message will appear on the Front Panel. In this case, try the following:

- Retry the Paper Advance Calibration.
- If necessary, perform a Printhead Recovery through the Front Panel and retry the Calibration.

**Remove the pattern from the printer and leave it to dry for a few minutes before continuing with the Calibration.**

**MAKE SURE NO MEDIA IS LOADED INTO THE PRINTER BEFORE STARTING TO SCAN THE CALIBRATION PATTERN.**

- 10** You will need to re-enter the Paper Advance Calibration submenu and scroll to "Scan Calibration Pattern" and press **Enter**.



- 11** When the following message appears on the front panel, you must select whether you would like to continue with the calibration by pressing the **Enter** key. Press **Back** or **Cancel** to exit the calibration.

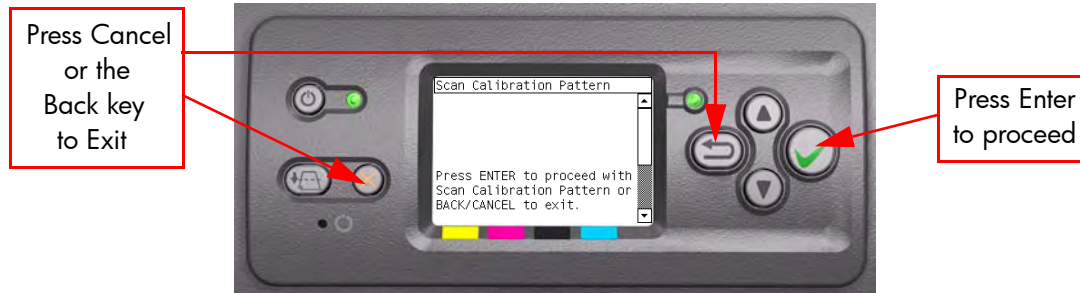

- 12** A message will appear advising you that you will need to load the Calibration Pattern in to the Printer. Make sure that you rotate the printed pattern 90° clockwise and reload it printed-side down, so that the black arrows go into the printer first. Press the **Enter** key to continue.

```
Scan Calibration Pattern
Press ENTER to proceed with
the load of the printed
pattern cut sheet as roll
for scanning. Rotate the
sheet 90 degrees clockwise
and press ENTER to proceed.
```

**Take note that the Calibration Pattern will be loaded as a Roll and NOT as a Sheet.**

**Only scan the Calibration Pattern in the Printer that was used to actually print it. Using the Calibration in a different Printer could cause it to experience media advance problems. After scanning the Calibration Pattern, it should be discarded.**

**When Loading the Calibration Pattern, use the Cutter blade on the Print Platen to align the edge of the sheet. If you follow this advise, you will prevent the cutter from cutting a section of the Calibration Pattern, which could cause the Calibration to fail.**

- 13** Load the Calibration Pattern following the instructions on the Front Panel. Once the Calibration Pattern is loaded correctly, the following message will be displayed on the Front Panel. Press the **Enter** key to continue.

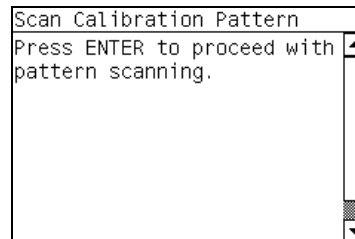

- 14** The Printer will scan the Calibration Pattern which could take several minutes. Once the calibration is completed successfully, the following message will be displayed on the Front Panel. Press the **Enter** key to continue.

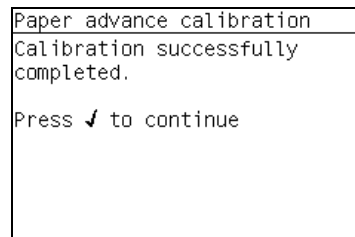

If the Paper Advance Calibration fails for any reason, a warning message will appear on the Front Panel. In this case, try the following:

- Check that the Calibration Pattern was not incorrectly cut (trimming the actual pattern) during the media load process. If this is the case, perform the Paper Advance Calibration again from **step 1**.
- Perform a Line Sensor Calibration (⇒ Page 5-16) and then rescan the Calibration pattern.
- Replace the Line Sensor ⇒ Page 8-31.
- If the problem continues, replace the Media-Axis Motor ⇒ Page 8-62.

**After the Paper Advance Calibration has been performed correctly, you MUST perform the Clean Drive Roller procedure. If this is NOT done, the Printer will not perform correctly and could cause Print Quality problems.**

**Before starting the Clean Drive Roller procedure, make sure you first load media into the Printer that the customer will normally use to print.**

- 15** You will need to re-enter the Paper Advance Calibration submenu and scroll to "Clean Drive Roller" and press **Enter**.



- 16** When the following message appears on the front panel, you must select whether you would like to continue with the cleaning of the Drive Roller by pressing the **Enter** key. Press **Back** or **Cancel** to exit the calibration.

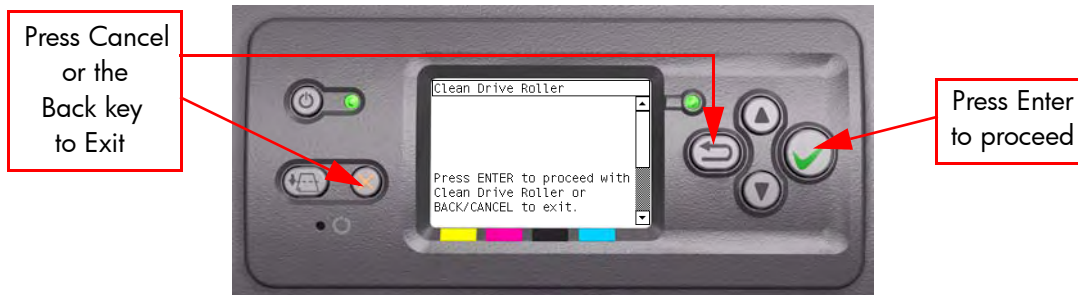

- 17** The Printer will begin the Drive Roller Cleaning procedure. This could take several minutes during which the following message will be displayed on the Front Panel.

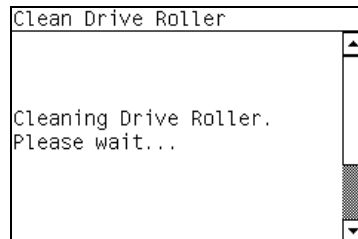

## 4. Drop Detector Calibration

The purpose of this Service Calibration is to calibrate the Drop Detector (located in the Service Station) in relation to the Carriage Assembly.

Perform the Drop Detector Calibration whenever:

- Drop Detector is disassembled or replaced.

Perform the Drop Detector Calibration as follows:

- 1 In the Service Calibrations submenu, scroll to "Drop Detector Calibration" and press **Enter**.

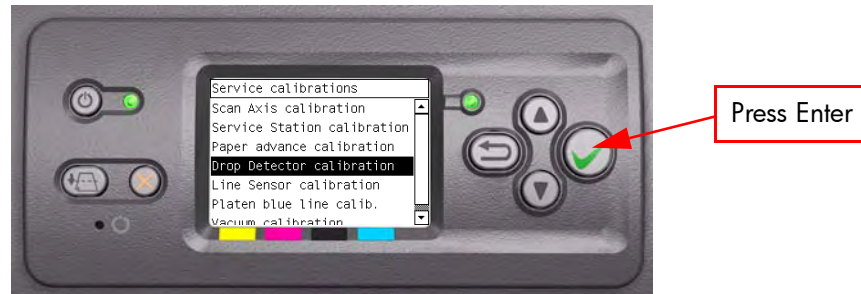

- 2 When the following message appears on the front panel, you must select whether you would like to continue with the calibration by pressing the **Enter** key. Press **Back** or **Cancel** to exit the calibration.

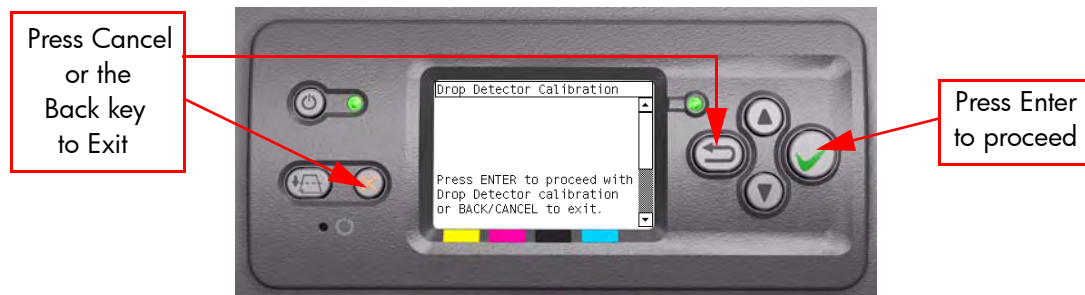

- 3 The Printer will start to calibrate the Drop Detector. Once the Drop Detector has been calibrated, the results will be displayed on the Front Panel. Press any key on the Front Panel to finish the calibration.

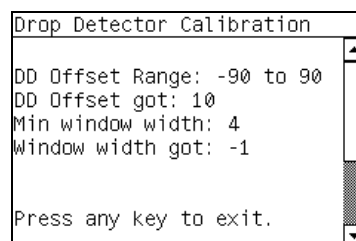

- 4 Once the calibration is completed, OK will be displayed on the Front Panel.

## 5. Line Sensor Calibration

The purpose of this Service Calibration is to calibrate the intensity of the line sensor in the Carriage PCA. An incorrect calibration can result in edge-detection failures during media loading and incorrect reading of prints that are used for alignment or calibration.

Perform the Line Sensor Calibration whenever:

- Edge detect procedure fails during media loading.
- Carriage is disassembled or replaced.
- Line Sensor is disassembled or replaced.
- Banding is detected in prints.
- Misalignment between colors is detected.

Perform the Line Sensor Calibration as follows:

**Make sure you load one of the following media into the Printer before performing this calibration:**

- **HP Bond Paper.**
- **HP Glossy Media.**
- **HP Coated Paper.**
- **HP Productivity Photo Gloss.**
- **HP Heavyweight Coated Paper.**
- **HP Super Heavyweight Coated Paper.**
- **HP Bright White Inkjet Paper.**

- 1 In the Service Calibrations submenu, scroll to "Line Sensor Calibration" and press **Enter**.

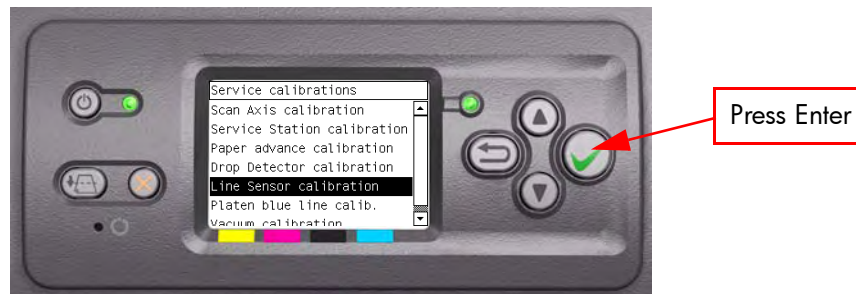

- 2 When the following message appears on the front panel, you must select whether you would like to continue with the calibration by pressing the **Enter** key. Press **Back** or **Cancel** to exit the calibration.



- 3 If media is not loaded, the following message appears on the front panel. Load media in to the Printer and start again from **step 1**.

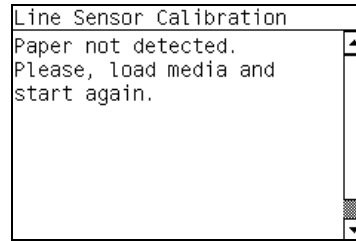

Before continuing, the Printer will check the following:

- The Media Lever is in the lowered position.
- The correct paper type is loaded (check list on previous page).
- The correct paper size (minimum paper size 24 inches).

If these conditions are **not** met, a warning will be displayed on the Front Panel and you will need to restart the Calibration from **step 1**.

**Make sure you keep your hands away from the Print Platen as the Carriage will be moving at high speed and you could injure yourself or damage the Carriage Assembly.**

- 4 The Printer will start to calibrate the Line Sensor. Once the Line Sensor has been calibrated, the results will be displayed on the Front Panel. Press Enter to continue or press **Back** or **Cancel** to exit the calibration.

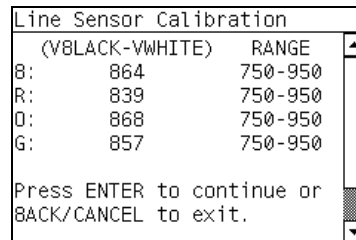

If the values are not within the range specified, an error will appear on the Front Panel. In this case, try the following:

- Try the Scan-Axis Calibration again.
- Replace the Line Sensor ⇒ Page 8-31.

- 5 The Printer will start to calibrate the Line Sensor position to the Black Printhead. It will print a line of black dots and then scan them:

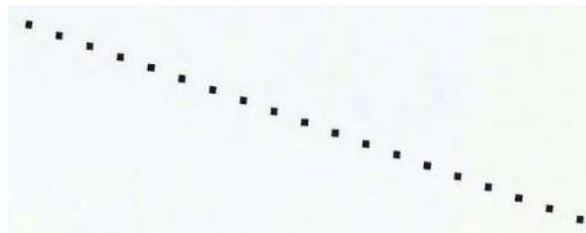

- 6 Once the Line Sensor has been calibrated, the results will be displayed on the Front Panel. Press **Enter** to finish the calibration or press **Back** or **Cancel** to exit the calibration.

```

Line Sensor Calibration
Y Offset Range: 30 to 59
Y Offset got: 43
X Offset Range: -24 to 24
X Offset got: 14
X SVS Offset: -1050 to 1050
X SVS Offset got: -944
Press any key to exit.

```

- 7 The Printer will now perform the Printhead Alignment. When the following message appears on the front panel, you must select whether you would like to continue with the calibration by pressing the **Enter** key. Press **Back** or **Cancel** to exit the calibration.

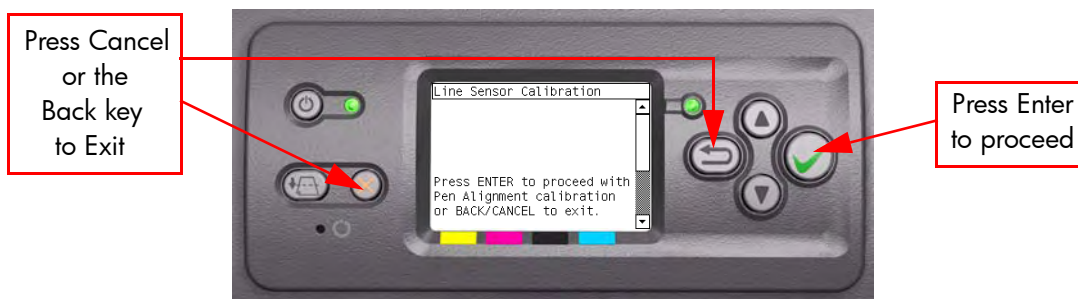

- 8 Once the Printhead Alignment is completed, the following message will be displayed on the Front Panel. Press the **Enter** key to continue.

```

Printhead alignment
Calibration successfully
completed.
Press ✓ to continue

```

If the Printhead Alignment fails for any reason, a warning message will appear on the Front Panel. In this case, try the following:

- Enter the Front Panel menu and retry the Printhead Alignment. If the Alignment completes successfully, then perform the Color Calibration.
- If the Alignment fails again, check the Alignment pattern to see if any of the Printheads are printing incorrectly. If necessary, perform a Printhead Recovery through the Front Panel and retry the Printhead Alignment.



- 9 The Printer will now perform the Color Calibration. When the following message appears on the front panel, you must select whether you would like to continue with the calibration by pressing the **Enter** key. Press **Back** or **Cancel** to exit the calibration.

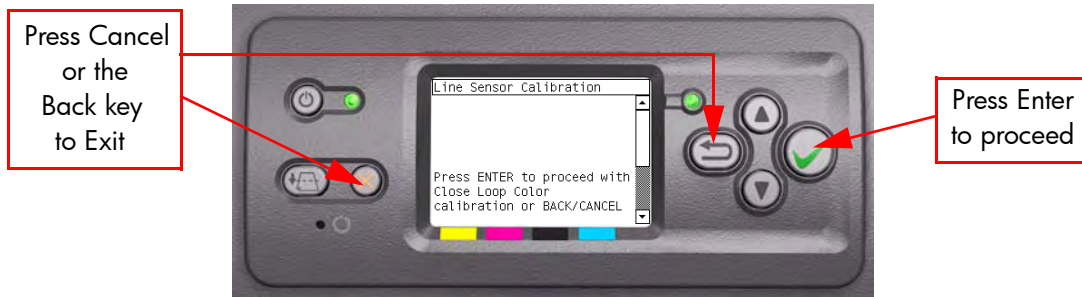

- 10 Once the Color Calibration is completed, the following message will be displayed on the Front Panel. Press the **Enter** key to continue.

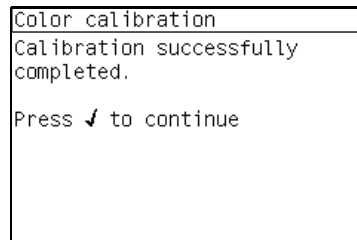

All CLC profiles are deleted so you will need to perform Color Calibration again for every new media that is loaded in to the Printer.

If the Color Calibration fails for any reason, a warning message will appear on the Front Panel. In this case, try the following:

- Enter the Front Panel menu and retry the Color calibration.
- If the Calibration fails again, check the Calibration pattern to see if any of the Printheads are printing incorrectly. If necessary, perform a Printhead Recovery through the Front Panel and retry the Calibration.

- 11 Once the complete Line Sensor calibration is completed successfully, OK will be displayed on the Front Panel.

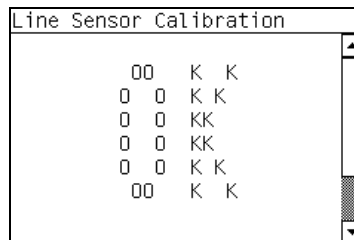

**This Calibration will be available from FW Version 3.x.x.x**

## 6. Platen Blue Line Calibration

The purpose of this Service Calibration is to calibrate the blue line which is marked on the Print Platen.

**Make sure you unload media before performing this calibration.**

Perform the Platen Blue Line Calibration whenever:

- Center Platen is disassembled or replaced.

Perform the Platen Blue Line Calibration as follows:

- 1 In the Service Calibrations submenu, scroll to "Platen blue line calib." and press **Enter**.

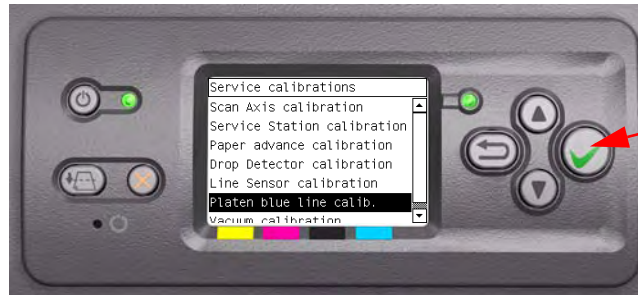

Press Enter

- 2 When the following message appears on the front panel, you must select whether you would like to continue with the calibration by pressing the **Enter** key. Press **Back** or **Cancel** to exit the calibration.

Press Cancel or the Back key to Exit

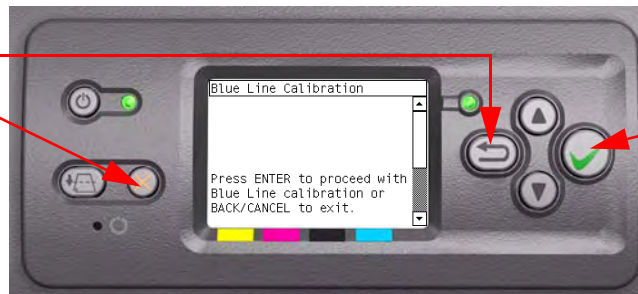

Press Enter to proceed

- 3 A message will appear on the Front Panel requesting you to raise the Media Lever and to place a sheet of white media on the Print Platen aligned with the Blue Line. Press the **Enter** key to continue once the sheet is in placed.

Blue Line Calibration  
Please, open the cover, open the pinch lever and place a sheet on the platen aligned with the right blue line. Then close the pinch lever and the cover.  
Press any key to continue.

Align sheet with Blue Line without covering it

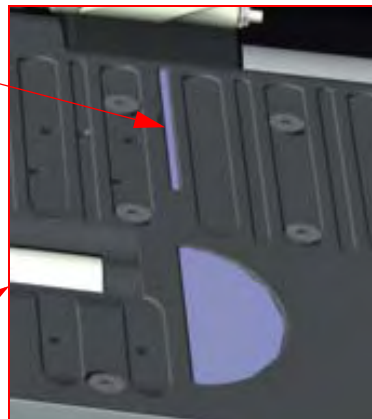

- 4** The Printer will start to calibrate the Blue Line and the following message will be displayed on the Front Panel.

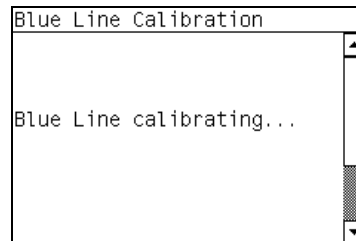

- 5** Once the Blue Line has been calibrated, the following message will be displayed on the Front Panel. Open the Window and remove the sheet of media that you had placed on the Print Platen. Press any key on the Front Panel to continue once the sheet of media has been removed.

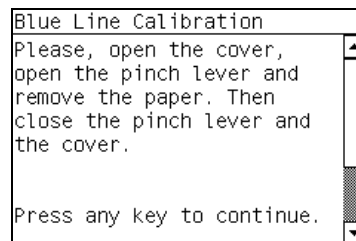

- 6** The results of the calibration will be displayed on the Front Panel. Press any key on the Front Panel to finish the calibration.

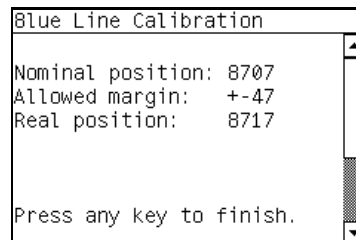

- 7** Once the calibration is completed, OK will be displayed on the Front Panel.

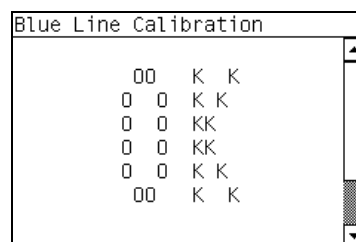

**This Calibration will be available from FW Version 3.x.x.x**

## 7. Vacuum Calibration

The purpose of this Service Calibration is to set the default nominal and real values of the Vacuum Fan Assembly.

**This Service Calibration should ONLY be performed when the Vacuum Fan Assembly has been replaced.**

Perform the Vacuum Calibration as follows:

- 1 In the Service Calibrations submenu, scroll to "Vacuum Calibration" and press **Enter**.

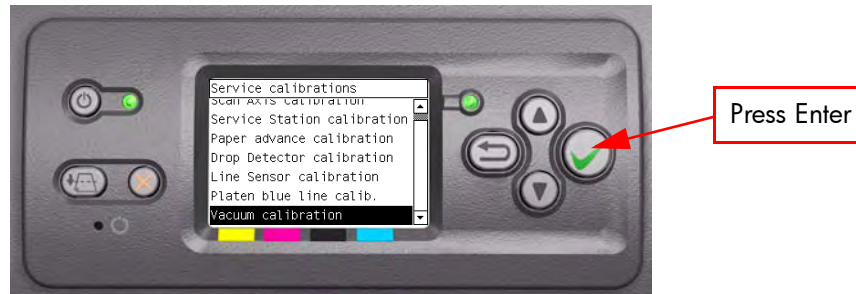

- 2 When the following message appears on the front panel, you must select whether you would like to continue with the calibration by pressing the **Enter** key. Press **Back** or **Cancel** to exit the calibration.

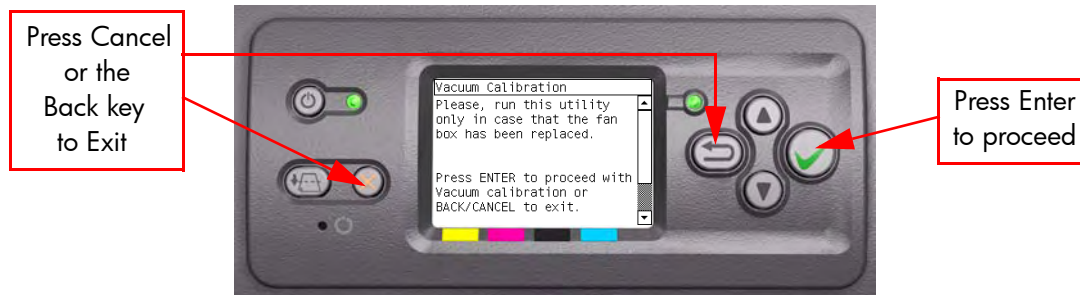

- 3 The Printer will set the default nominal and real values of the Vacuum Fan.

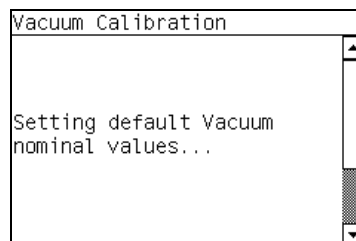

- 4 Once the calibration is completed, OK will be displayed on the Front Panel.

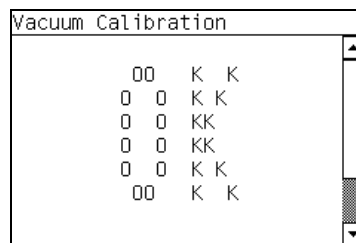

**PHONE SUPPORT**

## 8. Carriage Setup

The purpose of this Service Calibration is to reset the ink short thresholds after replacing the Carriage PCA.

**From Firmware Version 4.x.x.x, "Carriage Setup" will be moved from Service Utilities to the Service Calibrations section.**

Perform the Carriage Setup as follows:

- 1 In the Service Calibrations submenu, scroll to "Carriage Setup" and press **Enter**.
- 2 When the following message appears on the front panel, you must select whether you would like to continue with the Carriage Setup by pressing **Enter**. Press **Back** or **Cancel** to exit the utility.

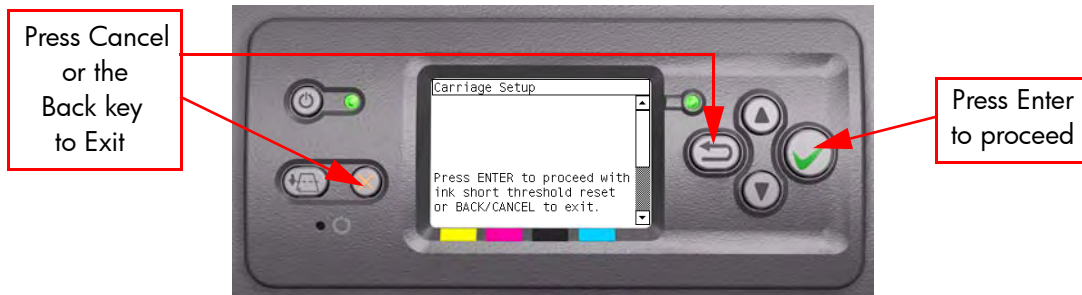

- 3 If the Ink Short Thresholds have been reset correctly, the following message will be displayed on the Front Panel. Press any key to exit:

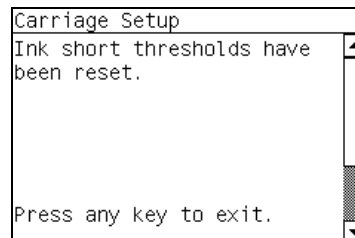

If any of the Printhead ink short thresholds cannot be reset or if the Printheads info cannot be accessed, it could point to a possible Firmware error.

- 4 If the utility exits correctly, OK will be displayed on the Front Panel.

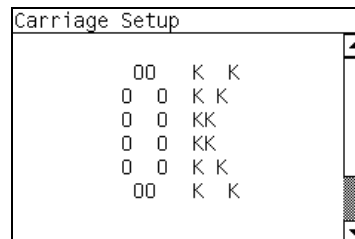



# Print Quality

# 6

- Print Quality 6-2
  - Print Quality Troubleshooting Actions 6-2
  - Choosing the Correct Print Quality Settings 6-3
- How to Use the Service Image Quality Diagnostic Print 6-5
  - What is the Service Image Quality Diagnostic Print? 6-5
  - Considerations for Printing the Diagnostic Print 6-5
  - Printing the Service Image Quality Diagnostic Print 6-6
  - Diagnostic Part 1: Alignment Test 6-7
  - Diagnostic Part 2: Printheads & Paper Advance Test 6-8
  - Diagnostic Part 3: Printhead Problems 6-9
  - Nozzle Print Test 6-11
  - No Printing Defects Found in the Diagnostic Print 6-12
  - Print Quality General Advice 6-12
- Troubleshooting Print Quality Problems 6-13
  - Horizontal Lines Across the Image (Banding) 6-13
  - Advanced Banding Troubleshooting for Experts 6-14
  - Dark Light Zone Banding (DLZB) 6-17
  - Lines are Missing or Thinner than Expected 6-18
  - Solid Bands or Lines Printed Over the Image 6-19
  - Problems with Graininess 6-20
  - Print Smudges when Touched 6-20
  - Paper is not Flat 6-21
  - Defect Near the Top of the Print 6-22
  - Problems with Stepped Lines 6-23
  - Lines are Printed Double or in Wrong Colors 6-23
  - Lines are Blurred (Ink Bleeds from Lines) 6-24
  - Problems with Color Accuracy 6-24
  - Problems with PANTONE Color Accuracy 6-25
  - Color Matching Between Different HP Designjet Printers 6-26
  - Problems with Image Clipping 6-28
  - Image is Completely Blank 6-29
  - Output Only Contains a Partial Print 6-29
  - Image is in One Portion of the Printing Area 6-30
  - Image is Unexpectedly Rotated (PostScript Driver) 6-30
  - Print is Distorted or Unintelligible 6-31
  - Print is a Mirror Image of the Original 6-31
  - One Image Overlaps Another on the Same Sheet 6-31
  - No Output from the Printer 6-32
  - Pinchwheel Marks when using Glossy Media 6-32
  - VLS in 1 Pass Printmodes 6-33
  - VLS in First 3 Meters after a Media Load 6-34
  - Bubbles (Only occurs in Cyan, Magenta and Yellow) 6-34
  - Black Printhead: Decap Problem 6-35
  - Paper Expansion - Paper Advance (PEPA) 6-36
  - Bidirectional Offset in Light Color Density Areas 6-37
  - Ink Contamination on Yellow Printhead 6-37
  - Satellites in Black Lines 6-38

## Print Quality

**PHONE SUPPORT**

### Print Quality Troubleshooting Actions

**For some Print Quality problems, a Call Agent can try and troubleshoot the Printer by requesting the Customer to perform certain actions. Using this process, most problems can be resolved without the need of an on-site visit.**

When faced with a Print Quality problem, perform the following actions in order to resolve the problem:



- 1** Printer Configuration:
  - Check that the **paper type** selected in the Front Panel is the same as the paper type loaded into the Printer.
  - Check that the correct "Optimized For" print quality setting is being used. This can be done either through the driver or through the front panel (Setup Menu/Printing Defaults Menu/Image Quality/Print Quality/Optimized For).
  - Make sure that the correct Print Quality settings are used for different types of print content. Refer to Page 6-3 for further information.
  - Dry time should be set to "Automatic".
- 2** Perform Printhead recovery (Ink Menu/Printheads/Recover Printheads).
- 3** Media:
  - Select the correct media type through the front panel when loading it.
  - Make sure that HP or HP-approved media is being used.
- 4** Perform the Printhead Alignment (Ink Menu/Printheads/Align Printheads). The Printhead Alignment can take up to 15 minutes.
- 5** Check if the latest version of the firmware is installed. If not, install the latest firmware revision.
- 6** For further information, refer directly to the Troubleshooting section that covers the different Print Quality problems (refer to Page 6-13).



## Choosing the Correct Print Quality Settings

The following table shows suggested print quality settings and paper types for various different kind of prints, assuming that **roll** paper is being used. If **sheet** paper is being used, it is recommended to set print quality to **Best**.

**High Density images should be printed on heavier paper (Heavyweight or Glossy).**

Print content	Image quality settings			Paper types (front panel)
	Print quality	Optimized for	Maximum detail	
Lines (draft) 	Fast	Drawings/ text	On	Bright White Bond Paper Translucent materials* Coated Paper
Lines 	Normal	Drawings/ text	Off	Bright White Bond Paper Translucent materials* Coated Paper
Lines and area fills 	Best	Drawings/ text	Off	Bright White Bond Paper Translucent materials* Coated Paper Heavyweight Coated Paper Productivity Photo Gloss

Print content	Image quality settings			Paper types (front panel)
	Print quality	Optimized for	Maximum detail	
Lines and images 	Best	Drawings/ text	On	Coated Paper Heavyweight Coated Paper Productivity Photo Gloss
In-store advertising 	Normal	Images	Off	Coated Paper Heavyweight Coated Paper Productivity Photo Gloss
Renderings 	Best	Images	Off	Heavyweight Coated Paper Productivity Photo Gloss
Photographs 	Best	Images	Off	Productivity Photo Gloss

## How to Use the Service Image Quality Diagnostic Print

### What is the Service Image Quality Diagnostic Print?

**In order to troubleshoot Print Quality problems, refer directly to the Troubleshooting section that covers the different Print Quality problems (refer to Page 6-13). Do NOT use the Diagnostic Print on it's own to troubleshoot Print Quality Problems.**

The Printer contains an internal Image Quality Test which helps you to diagnose the possible source of any image quality defects. The Service IQ Diagnostic Print is available in two options:

- 1 *Image Quality User plot.* This can be printed either through the normal front panel menu or through the Service Utility Menu.
  - a If the Image Quality Diagnostic Print is printed through the Service Utility Menu, you will **not** be prompted to select "optimized for drawings/text" or "optimized for images". The Printer will automatically take the settings that have already been selected in "Setup Menu/Printing Defaults Menu/Image Quality/Optimized for".
  - b If the Image Quality Diagnostic Print is printed through the standard menu (Setup Menu/Information Menu/Internal Prints/Print Image Diagnostics) you will be prompted to select "drawings/text" or "images". It is recommended to print the Diagnostic Print using this option.

The Image Quality User Plot print is divided in to three parts as follows:

- Alignment Test. This test is designed to check any color-to-color and bi-directional misalignment the printer may have.
  - Printheads and Paper Advance test. This test is designed to check whether the Printheads and the Paper Advance Mechanism are working correctly.
  - Printhead Problems. The purpose of this test is to identify which Printhead is faulty.
- 2 *Image Quality Service Plot.* This can **only** be printed through the Service Utility Menu. This print contains the Printhead Nozzles test, which is designed to check if the printhead nozzles print correctly.

### Considerations for Printing the Diagnostic Print

- 1 The IQ Diagnostic Print prints in A3 and B sizes so you must have media loaded (roll or sheet) that is this size or larger.
- 2 Use the same type of media that the customer was using when they found the image quality problem.
- 3 If the customer is using non-HP media and after the Image Quality Test you still have the same image quality problems, change to genuine HP media and repeat the Image Quality Test.
- 4 If you do not see any problems with the Image Quality Test, then the problem may not be with the printer itself. The problem may be with the RIP or the driver for example.

However, if you do see problems with the Image Quality Test then continue with the following procedures which will help you to diagnose the problem.

## Printing the Service Image Quality Diagnostic Print

- 1 In the Service Utilities submenu, scroll to "Diagnostic Print" and press **Enter**.



- 2 You will be given an option to either print the "Image Quality User Plot" or the "Image Quality Service Plot". Use the **Arrow** keys to make the selection and press the **Enter** key to start printing the required Diagnostic Print.



- 3 Make sure media is loaded, the Pinch Lever is lowered and that the Ink System is correctly installed. Press the **Enter** key to print the Diagnostic Print or press **Back/Cancel** to exit without printing the Diagnostic Print.

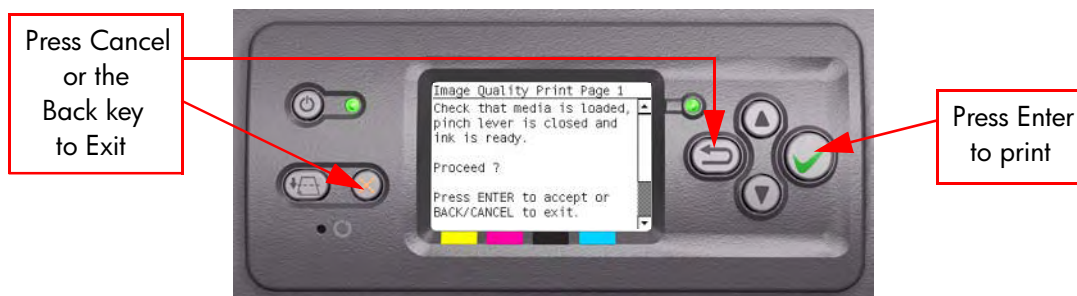

- 4 The selected Diagnostic Print will now be printed.

## Diagnostic Part 1: Alignment Test

This test is designed to check any color-to-color and bi-directional misalignment the printer may have.

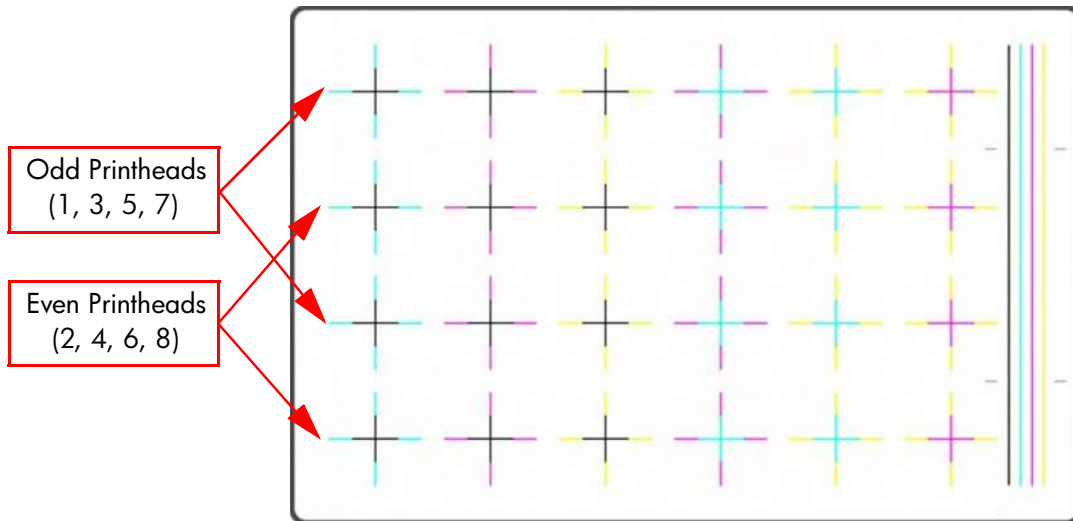

- 1 If the Printer is experiencing **horizontal** misalignment problems, the Alignment Test will show something like this:

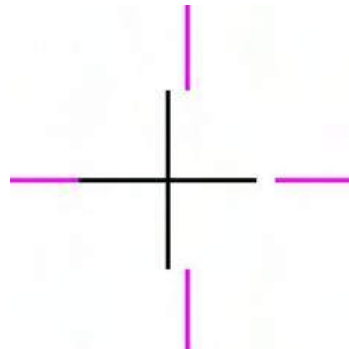

- 2 If the Printer is experiencing **vertical** misalignment problems, the Alignment Test will show something like this:

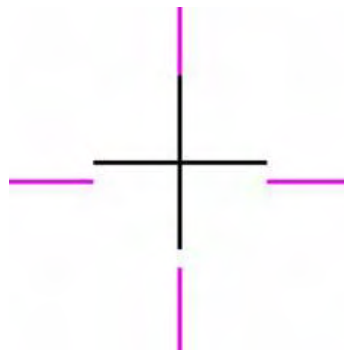

- 3 If the Printer is experiencing **bi-directional** misalignment problems, the Alignment Test will show something like this:

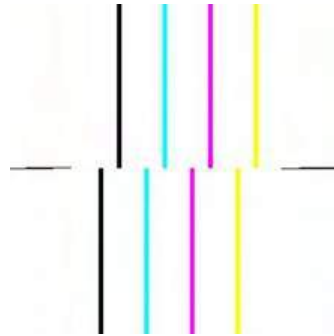

### Corrective Action

- 1 Perform a Printhead Alignment, using the same paper type with which you were experiencing unacceptable image quality, if feasible (some paper types are not suitable for Printhead Alignment).

## Diagnostic Part 2: Printheads & Paper Advance Test

This test is designed to check whether the Printheads and the Paper Advance Mechanism are working correctly. This part of the Image Quality Test should **not** be used to check for color consistency or accuracy.

### Banding

If the Printer is experiencing a banding problem, you will see repetitive horizontal bands within the printed image. Banding can appear as follows:

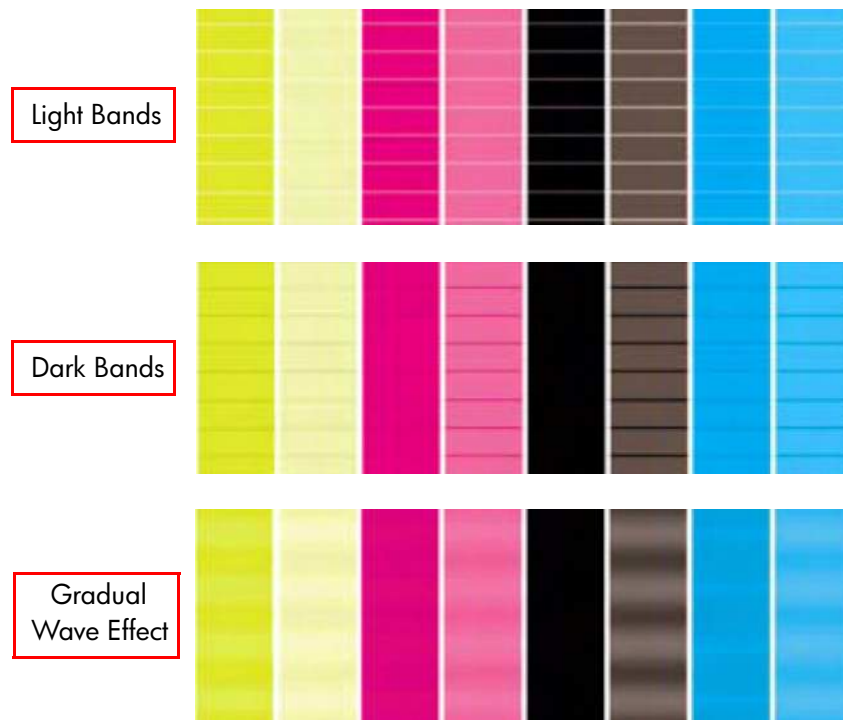

### Troubleshooting Banding Problems

If banding **does not** occur in ALL the colors, then it is more than likely a Printhead problem. In this case, try the following:

- 1 Check that the appropriate print quality settings are being used. Refer to Page 6-3 for further information on choosing the correct Print Quality settings.
- 2 Recover the printheads using the option through the Front Panel (Ink Menu/ Printheads/Recover Printheads). Reprint the Diagnostic Print or the print file and if the problem persists:
  - As there are two Printheads for each color, check exactly which Printhead is causing the problem ? Page 6-9.
  - If the problem continues, replace the faulty Printhead.

If banding **does** occur in ALL the colors, then it is more than likely a Paper Advance problem:

- If the bands are light, it means that the paper has advanced too much.
- If the bands are dark, it means that the paper hasn't advanced enough.
- In high quality modes, graininess in ALL colors can indicate problems either with alignment or Paper Advance.

**There is a high chance of seeing dark banding in the black bars of the Diagnostic Print when printing with optimized for drawings/text. This is NOT caused by a black Printhead issue as we described previously.**

In order to solve any of these problems, try the following:

- 1 Check that the appropriate print quality settings are being used.
- 2 If the customer is using low quality paper, try recommending better quality paper (preferable HP paper). Printer performance can only be guaranteed by using recommended papers.
- 3 Perform the Paper Advance Calibration using the same type of paper that will be used for the final print.

### Diagnostic Part 3: Printhead Problems

If part 2 revealed a Printhead problem, then the purpose of part 3 is to identify exactly which Printhead is faulty. Each rectangle in this part is identified with the number of the Printhead that produced it.

If ALL the Printheads are printing perfectly, part 3 of the Diagnostic print will look like this:

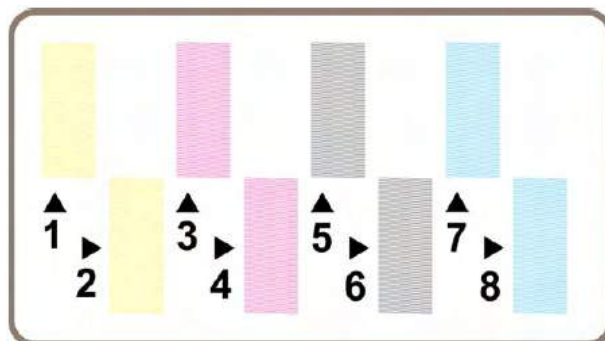

The following example shows an imperfect Printhead (number 4) that is still suitable for printing. It is not damaged enough to warrant a replacement because the Printer can compensate for a number of faulty nozzles.

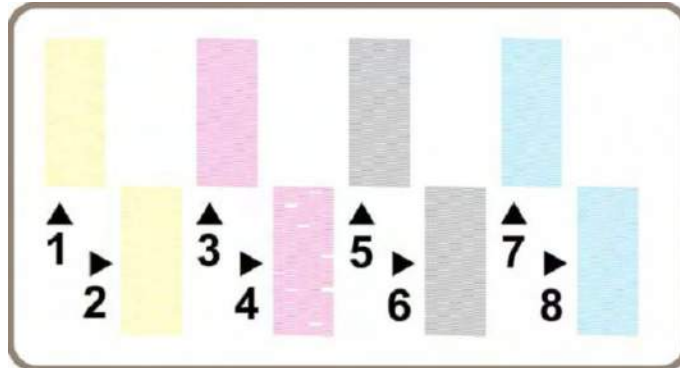

### Analyzing Printhead Nozzles

Do not expect perfection, because even if there are only a few missing lines, the Printer can compensate for this so there is no need to replace the Printhead. Up close, the rectangle printed by a faulty Printhead in part 3 of the Diagnostic Print may look like some of these examples.



Faulty - Replace



Faulty - Replace



Acceptable

### Troubleshooting a Faulty Printhead

- 1 If part 3 of the Diagnostic Print shows a problem with one Printhead, but part 2 of the Diagnostic Print shows no problem, then:
  - No immediate corrective action is required.
  - The printer will compensate for the problem and maintain Image Quality.
- 2 If both parts 2 and 3 of the Diagnostic Print show a problem, then:
  - Recover the printheads using the option through the Front Panel (Ink Menu/Printheads/Recover Printheads).
  - If the problem continues, replace the faulty Printhead.



## Nozzle Print Test

The Nozzle Print Test is part of the Image Quality Service Plot. This can **only** be printed through the Service Utility Menu. This test is designed to check if the printhead nozzles print correctly. The test prints out every single nozzle of each Printhead. No error hiding or Printhead Alignment algorithm is applied. For each Printhead, you can see both the adjacent and the consecutive nozzles.

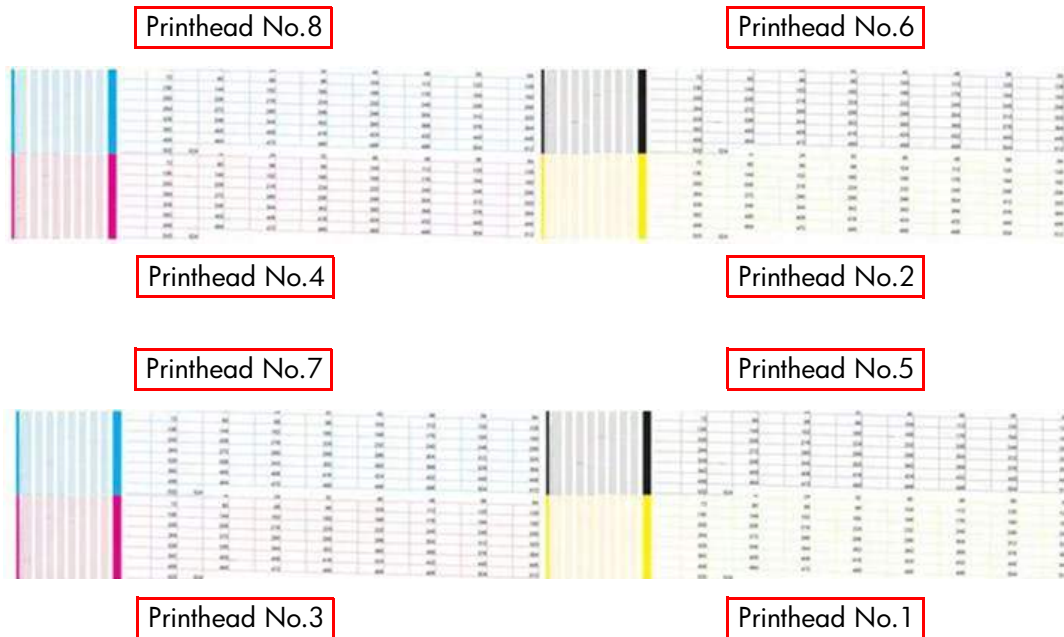

This is what you would see if there are nozzles not printing correctly:

- 1 On the right of each Printhead Nozzle test, there is a series of numbered stepped diagonal lines. If one or more of the nozzles are malfunctioning or mis-positioned, you will see that the stepped lines are broken or misdirected in one or more places.
- 2 On the left of each Printhead Nozzle test, there is a series of horizontal straight lines. If one or more nozzles are misdirected there will be unequal spaces between the corresponding lines.

### How to fix the Nozzle Defects

**If the printer has nozzle defects, it does not mean that you will not get perfect print quality results. The printer has automatic procedures to hide many nozzle defects.**

- 1 Recover the printheads using the option through the Front Panel (Ink Menu/ Printheads/Recover Printheads).
- 2 Reprint the Nozzle Print test to check that the defective nozzles have been corrected.
- 3 If the problem continues, replace the faulty Printhead.

## No Printing Defects Found in the Diagnostic Print

If all the test patterns from the Diagnostic Print are correct and you still experience Image Quality problems, here are some of the more likely causes to check:

- The print mode used in your printer is not right for the image you are printing (this is defined by the printer's front-panel menu selections).
- Make sure that the **paper type** selected in the Front Panel is the same as the paper type loaded into the Printer.
- Non-HP driver.
- The RIP (If you are using one).
- The software applications you are using.

## Print Quality General Advice

- 1** To achieve the best performance from the printer, only genuine HP accessories and supplies should be used.
- 2** Make sure that the **paper type** selected in the Front Panel is the same as the paper type loaded into the Printer.
- 3** Roll paper usually gives better Print Quality than a single sheet of the same type of paper.
- 4** When single sheets are being used, it is recommended to use the **Best** print quality setting.
- 5** The most appropriate print quality settings must be used for the current purpose. You are most likely to see print quality problems while using the **Fast** print quality setting.
- 6** In order to achieve the best print quality, at the expense of speed, always set "Printhead Monitoring" to "Intensive".
- 7** Check that the environmental conditions (temperature, humidity) are within the temperature/humidity range as specified for the Printer (refer to the User's Guide for further information).
- 8** Remember that certain print quality problems can be solved by:
  - Recovering the Printheads (Ink Menu/Printheads/Recover Printheads).
  - Aligning the Printheads (Ink Menu/Printheads/Align Printheads).
  - Performing the Paper Advance Calibration (Paper Menu/Paper Advance Calibration).

## Troubleshooting Print Quality Problems

### Horizontal Lines Across the Image (Banding)

#### Description of problem

When you look at the image you have printed, there are horizontal lines across the image. Shown below is an example of what you might see if you have this problem:



#### Corrective Action

- 1** Check that the appropriate print quality settings are being used and reprint the image. Refer to Page 6-3 for further information on choosing the correct Print Quality settings.
- 2** If not already done so, recover the Printheads (Ink Menu/Printheads/Recover Printheads) and reprint the image with the same settings as before.
- 3** Try using a heavier paper type. When printing dense colors, it is recommended to use HP Heavyweight Coated Paper or HP Productivity Gloss.
- 4** If the problem continues, Refer to the "Advanced Banding Troubleshooting for Experts" section on Page 6-14 to troubleshoot the problem further.

## Advanced Banding Troubleshooting for Experts

The flowchart on the following pages will help you troubleshoot some of the different banding issues the Print may have. If you have a banding issue, the main question you should ask is "What do you see?":

- If you see "White Lines", refer to this page.
- If you see "Dark Lines" refer to Page 6-15.
- If you see "Both White and Dark Lines", refer to Page 6-15.

### If you see "White Lines"

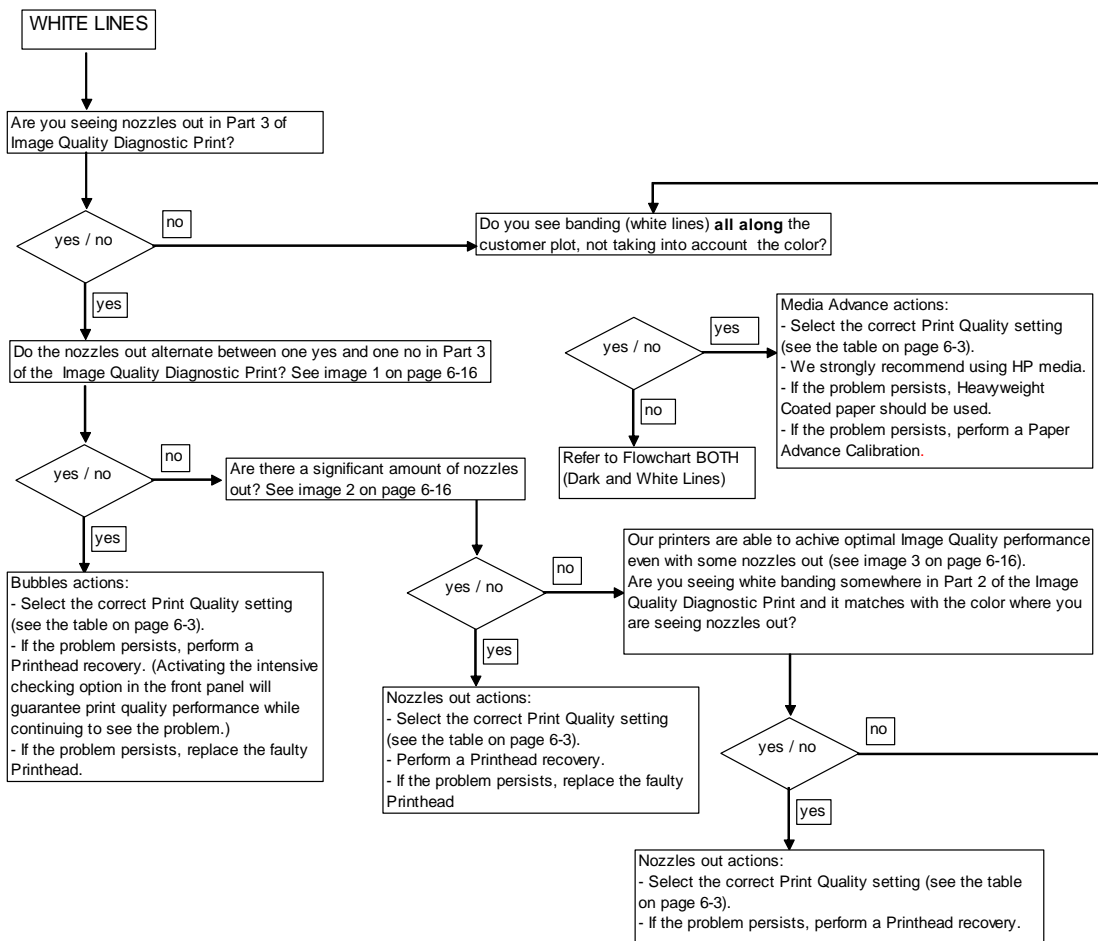

## If you see "Dark Lines"

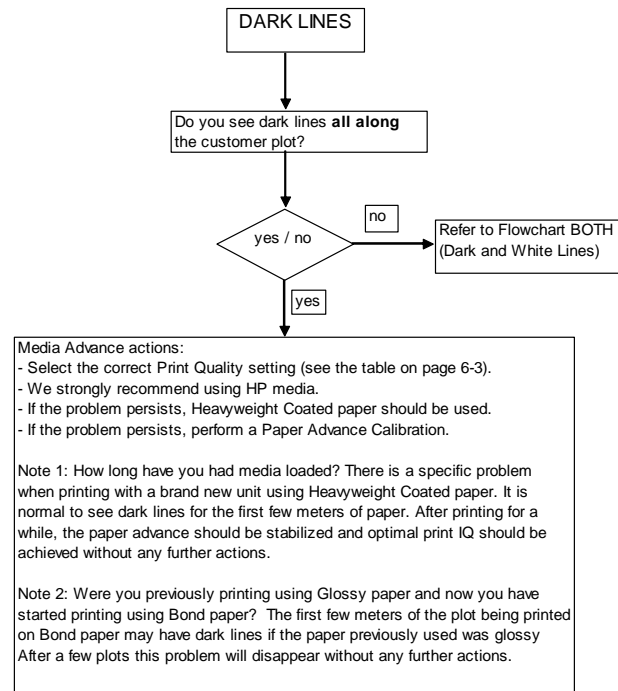

## If you see "Both White and Dark Lines"

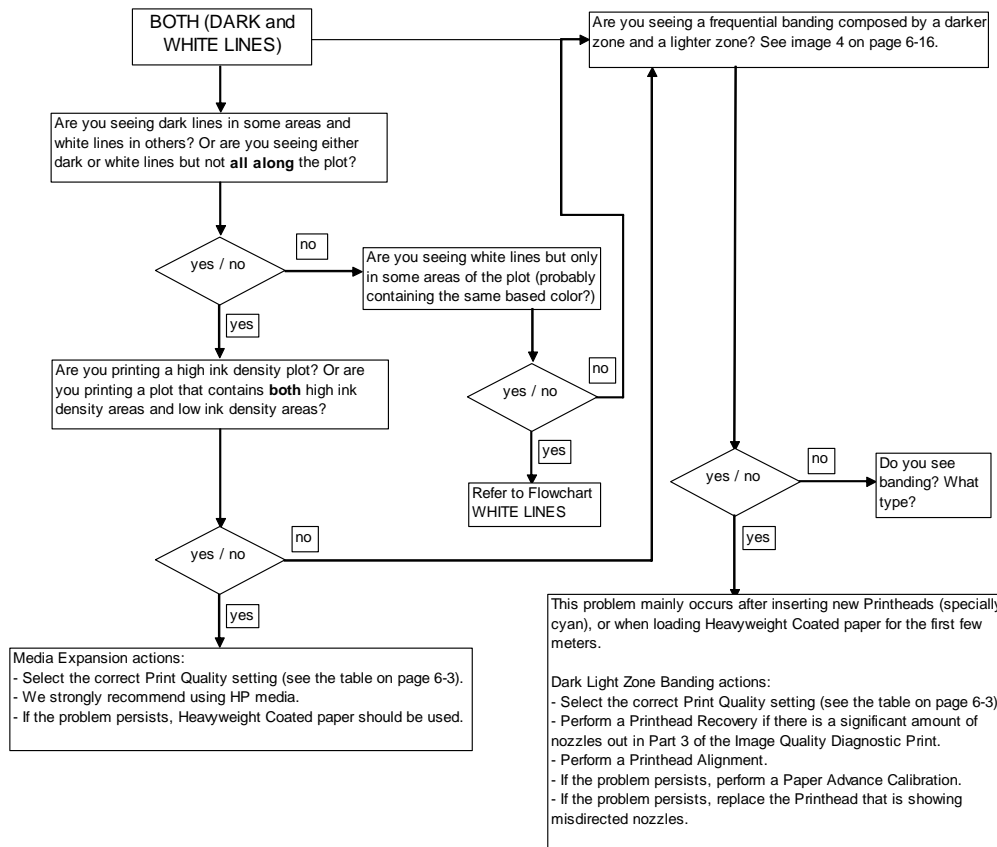

### Reference Images for Banding Flowcharts

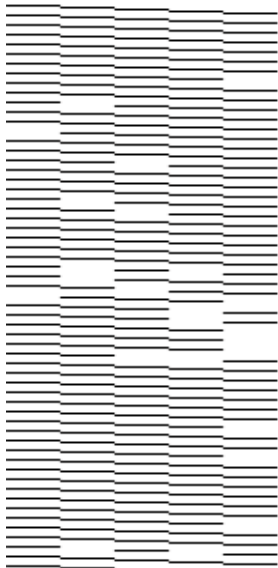

**Image 1**

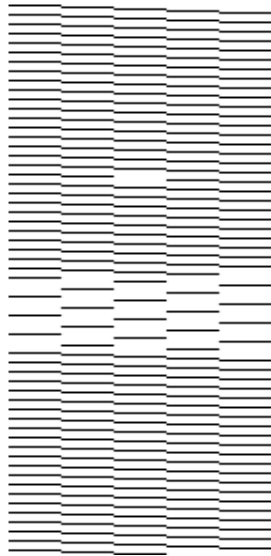

**Image 2**

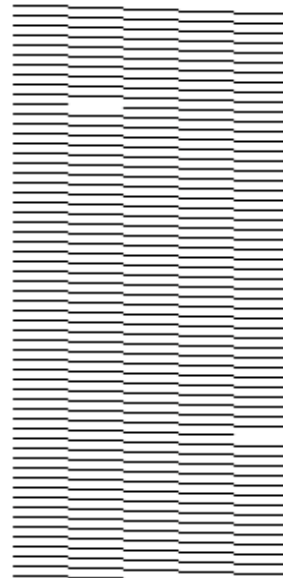

**Image 3**



**Image 4**

## Dark Light Zone Banding (DLZB)

### Description of problem

Shown below is an example of what you might see if you have this problem. It is often easier to see the issue at a distance of 50cm than at 10cm:



### Corrective Action

- 1 Using the Image Quality Diagnostic Print, check if there is a significant amount of nozzles out. If there is a significant amount of nozzles out (refer to image 1 on Page 6-16), then recover the Printheads (Ink Menu/Printheads/Recover Printheads) and reprint the image.
- 2 If the problem persists, align the Printheads (Ink Menu/Printheads/Align Printheads) and reprint the image.
- 3 If the problem persists, perform the Paper Advance Calibration (Paper Menu/Paper Advance Calibration).

**Only change the paper advance patch if a clear difference in terms of media advance is seen.**

- 4 If the problem persists, replace the Printhead that is showing misdirected nozzles.

## Lines are Missing or Thinner than Expected

### Description of problem

Shown below is an example of what you might see if you have this problem:

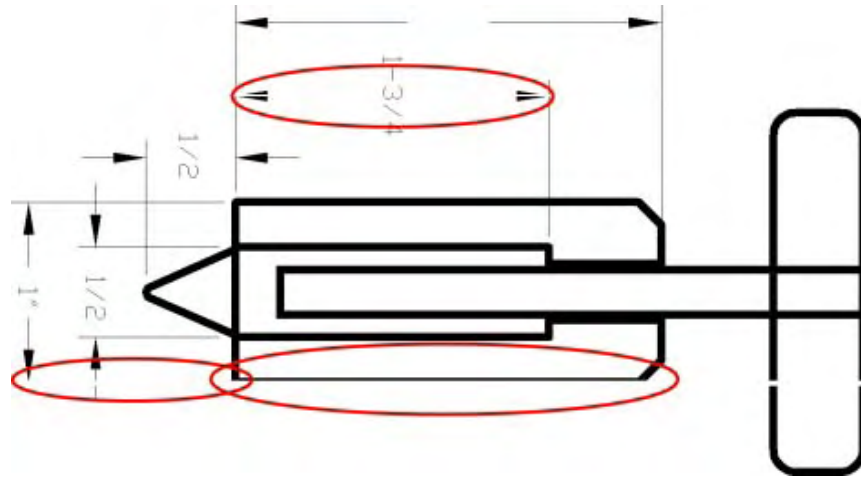

### Corrective Action

- 1** Check that the line thickness and color settings are correct in the application that was used to generate the image.
- 2** Check that the appropriate print quality settings are being used and reprint the image. Refer to Page 6-3 for further information on choosing the correct Print Quality settings.
- 3** Recover the Printheads (Ink Menu/Printheads/Recover Printheads) and reprint the image.
- 4** Try using a heavier paper type. When printing dense colors, it is recommended to use HP Heavyweight Coated Paper or HP Productivity Gloss.
- 5** Using Part 3 of the Image Quality Diagnostic Print, check if there is a significant amount of nozzles out in the color that is **actually causing** the problem (if see you a problem with the Black color in the customer print, then only check the Black printhead in the Image Quality Diagnostic Print). If there is a significant amount of nozzles out (refer to image 1 on Page 6-16) then replace the faulty Printhead.



## Solid Bands or Lines Printed Over the Image

### Description of problem

This kind of problem can show itself in several different ways:

- 1 A thick colored band.
- 2 Thinner colored bands.
- 3 Discontinued colored blocks.
- 4 Thin lines.

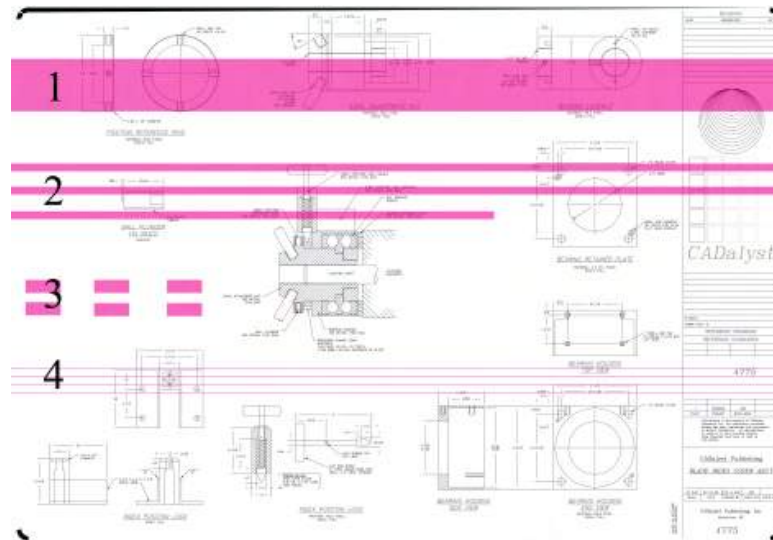

### Corrective Action

- 1 Clean the electrical connections of the Printhead that seems to be responsible for the problem (in this example, the Magenta Printhead is responsible).
- 2 Recover the Printheads (Ink Menu/Printheads/Recover Printheads).
- 3 Reprint the image with the same settings as before.
- 4 If the problem continues, replace the Printhead that seems to be causing the problem. If you are not sure which Printhead is responsible, use the Image Quality Diagnostic Print to identify it.

## Problems with Graininess

### Description of problem

Shown below is an example of what you might see if you have problems with graininess:



### Corrective Action

- 1 Follow the general advice given on Page 6-12.
- 2 Align the Printheads (Ink Menu/Printheads/Align Printheads).
- 3 If the image has been printed using the Normal or Fast print quality setting and it is not acceptable to the customer, then reprint it using the **Best** print quality setting.
- 4 If the problem continues, perform the Paper Advance Calibration.

## Print Smudges when Touched

### Description of problem

The black ink pigment can smudge when touched by a finger or a pen. This is particularly noticeable on the following materials:

- Vellum.
- Translucent Bond.
- Films.
- Productivity Photo Paper.
- Natural Tracing Paper.

To reduce the smudging, try the following:

- 1 Make sure the environment is not too humid for the Printer.
- 2 Change pure black objects in the image to a dark color (e.g. dark brown) so that they will be printed with the colored inks instead of the Black ink.
- 3 HP Heavyweight Coated Paper should be used instead.
- 4 Increase the drying time through the Front Panel (Ink Menu/Drying Options/Drying Time).

## Paper is not Flat

### Description of problem

If the paper does not lie flat when it comes out of the Printer, but has shallow waves in it, you are likely to see visible defects in the printed image, such as vertical stripes. This can happen when you use thin paper that becomes saturated with ink.

Shown below is an example of what you might see if you have problems with the paper not being flat:



### Corrective Action

- 1** Try using a heavier paper type. When printing dense colors, it is recommended to use HP Heavyweight Coated Paper or HP Productivity Gloss.
- 2** Make sure that only genuine HP paper is being used.
- 3** Check that the appropriate print quality settings are being used. Refer to Page 6-3 for further information on choosing the correct Print Quality settings.
- 4** Check that the environmental conditions (temperature, humidity) are within the temperature/humidity range as specified for the Printer (refer to the User's Guide for further information).

## Defect Near the Top of the Print

There are two types of defects which affect the top of the Print:

- Soft Landing.
- Avioneta.

### Soft Landing: Description of problem

There is a type of defect that affects only the top of the print, within 5.5 cm (2.17 inches) of the leading edge of the paper. You may see a thin or thick band of inconsistent color. This problem is caused because of the different grains that each Printhead has.

Shown below is an example of what you might see if you have this problem:

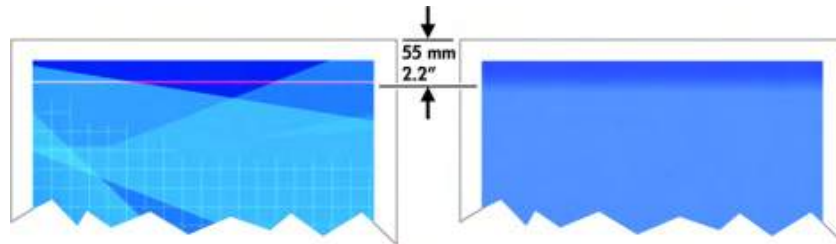

### Corrective Action

- 1 The easiest solution is to select the **Extended Margins** option in the driver, the Embedded Web Server or the Front Panel. This means that the area of the paper affected by the problem (at the top of the page) will no longer be used. If using the **Extended Margins** option is not possible, the try the following:
  - Recover the Printheads (Ink Menu/Printheads/Recover Printheads).
  - Align the Printheads (Ink Menu/Printheads/Align Printheads).
  - Perform the Paper Advance Calibration (Paper Menu/Paper Advance Calibration).
- 2 Check that the appropriate print quality settings are being used. Refer to Page 6-3 for further information on choosing the correct Print Quality settings.

### Avioneta: Description of problem

The Vacuum suction varies depending on the amount of media covering the printzone. The Vacuum suction increases as the beginning of the media advances over the printzone and this causes the Avioneta defect. This defect mainly affects CAD plots during the first swath and is seen as roughness or even as double lines.

### Corrective Action

- 1 The easiest solution is to select the **Extended Margins** option in the driver, the Embedded Web Server or the Front Panel. This means that the area of the paper affected by the problem (at the top of the page) will no longer be used.

## Problems with Stepped Lines

### Description of problem

When you look at the image you have printed there are **'stepped lines'** in the borders of arrows and diagonal lines. The lines should be straight with no stepping.

Shown below is an example of what you might see if you have problems with Stepped Lines:

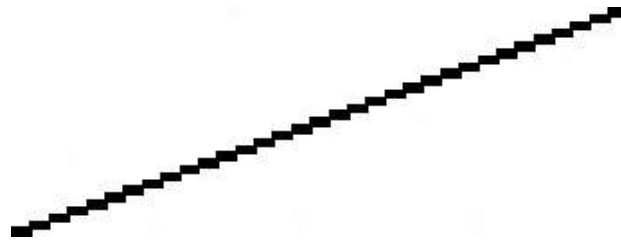

### Corrective Action

- 1 If the image has been printed using the Normal or Fast print quality setting and it is not acceptable to the customer, then reprint it using the **Best** print quality setting.
- 2 Turn On the "Maximum Detail" option in the Driver.
- 3 The problems may be inherent in the image that you are trying to print. Try to improve the image with the **application** that generated the file.

## Lines are Printed Double or in Wrong Colors

### Description of problem

This problem can have various visible symptoms, as shown below:

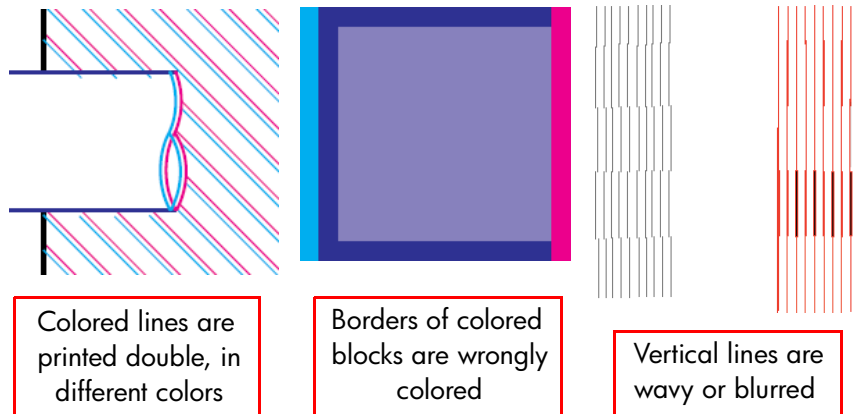

### Corrective Action

- 1 Align the Printheads (Ink Menu/Printheads/Align Printheads).
- 2 If the image has been printed using the Normal or Fast print quality setting and it is not acceptable to the customer, then reprint it using the **Best** print quality setting.

## Lines are Blurred (Ink Bleeds from Lines)

### Description of problem

This problem is often caused by the ink soaking into the paper, making the lines blurred and fuzzy. This could be because of the humidity in the air.

### Corrective Action

- 1 Print in a less humid environment.
- 2 Try using a heavier paper type, such as HP Heavyweight Coated Paper.

**Glossy Photo Paper types are especially difficult to dry. Take extra care with them.**

- 3 Make sure that the **paper type** selected in the Front Panel is the same as the paper type loaded into the Printer.
- 4 Increase the drying time through the Front Panel (Ink Menu/Drying Options/Drying Time).
- 5 Allow the prints time to dry separately; do NOT cover or stack them.

## Problems with Color Accuracy

There are two basic requirements for color accuracy:

- 1 Ensure that the paper type being used has been color calibrated, which will give color consistency from print to print, and from Printer to Printer.
- 2 Select suitable options in the application (refer to the User's Guide for more information).

**If PostScript is not being used, remember that the printer may be configured to use one of its internal pen palettes instead of the software's palette (which is the default).**

### Color accuracy using EPS or PDF images in page layout applications

Page layout applications such as Adobe InDesign and QuarkXPress do not support color management of EPS, PDF, or grayscale files.

If these types of files have to be used, try to ensure that the EPS, PDF, or grayscale images are already in the same color space that is intended to be used later on in Adobe InDesign or QuarkXPress. For instance, if the final objective is to print the job in a press that follows the SWOP standard, at the time of creating the EPS, PDF or grayscale the image should be converted into SWOP.

## Problems with PANTONE Color Accuracy

Spot colors are special premixed inks to be used directly in the press, and the best-known spot colors are PANTONE colors.

The PostScript Printer contains an option called Automatic PANTONE Calibration, which can easily match most of the PANTONE Solid Coated spot colors. When an application sends a PANTONE color to print, it sends the PANTONE name together with its own estimate of equivalent CMYK values. The Automatic PANTONE Calibration facility recognizes the PANTONE name and converts it to CMYK in a way that depends on the printer model and the selected paper type, enabling the color to be rendered with greater precision than is possible with the generic CMYK values sent by the application.

Even when using Automatic PANTONE Calibration, it cannot be expected that the printer matches the PANTONE colors exactly. The printer is certified by Pantone for some papers, but this does not mean that it can reproduce 100% of the PANTONE colors.

### Using Automatic PANTONE Calibration (the best choice)

In order to use Automatic PANTONE Calibration, an application that recognizes the PANTONE colors, and a calibrated PostScript Printer is needed.

The Automatic PANTONE Calibration facility emulates PANTONE Solid Coated colors only (suffix C). Other PANTONE colors will be printed using the CMYK values sent by the application.

### Converting PANTONE colors manually

If a non-PostScript Printer is being used, or if an application (such as Adobe Photoshop) is being used that does not send the name of the PANTONE color to the Printer, then the Automatic PANTONE Calibration will not be available. Instead, if required, each PANTONE color has to be manually converted to CMYK values in the application, using tables produced especially for the printer and paper type.

If the application has a facility to convert PANTONE colors to CMYK values automatically, it probably does not take into account the type of Printer or paper type, so better results will be achieved with a manual conversion using the tables.

A PANTONE calibrated color chart in EPS, TIFF, and PDF format can also be obtained, which can be convenient if the application being used has an eyedropper tool with which colors can be picked up from an imported graphic.

### Tips

- Automatic PANTONE Calibration works with PostScript printers only.
- Ensure that Automatic PANTONE Calibration is turned on in the driver.
- Some applications may not support PANTONE colors fully; for example, Photoshop 7.0 does not send the PANTONE Color with its name, it sends only the CMYK values from its standard table.
- Some colors may be out of gamut and impossible to match precisely with your Printer and paper type.

## Color Matching Between Different HP Designjet Printers

If an image is printed on two different Printer models (for instance, on an HP Designjet 4000 Printer series and an HP Designjet 1000 Printer series), you may find that the colors of the two prints do not match well.

Matching two printing devices that use different ink chemistry, paper chemistry, and Printheads is unlikely to be completely successful. The information provided here is the best way to emulate one Printer with another. Even so, the end result may not be a perfect match.

### Printing via separate PostScript drivers

The situation is that you are printing on each printer using the PostScript driver installed for that printer. In this example, we are using an HP Designjet 4000 Printer series and an HP Designjet 1000 Printer series.

- 1 Ensure that both printers have been updated with the latest firmware version.
- 2 Ensure that you have the latest printer driver for both printers. The latest versions can be downloaded from <http://www.hp.com/go/designjet>.
- 3 Ensure that Color Calibration is turned on (Setup Menu/Configuration Menu/Color calibration/On).
- 4 Load both Printers with similar paper types.
- 5 Ensure that the Paper Type setting on the front panel corresponds to the paper that is loaded.
- 6 Print the image on the HP Designjet 1000 Printer series using the normal settings.
- 7 Now prepare to print the same image on the HP Designjet 4000 Printer series.
- 8 In the application, set the color space of the image to emulate the HP Designjet 1000 Printer series and the specific paper type that you used in that printer. The data sent to the driver must be already converted to this emulation color space, which is a CMYK color space. refer to the application's online help for information on how to do this. In this way, the 4000 series will emulate the colors that the 1000 series can produce when printing on that paper type.
- 9 In the PostScript driver for the HP Designjet 4000 Printer series, go to the Color Management section and set the CMYK input profile to the same HP Designjet 1000 Printer series color space that was selected in the application (the emulation color space).

**When trying to emulate another printer, CMYK colors should always be used, not RGB.**

- 10 Set the rendering intent to Relative Colorimetric, or to Absolute Colorimetric if the whiteness of the paper needs to be emulated.
- 11 Print the image on the HP Designjet 4000 Printer series.



### Printing via separate HP-GL/2 drivers

The situation is that you are printing on each printer using the HP-GL/2 driver installed for that printer.

- 1 Ensure that both printers have been updated with the latest firmware version.
- 2 Ensure that you have the latest printer driver for both printers. The latest versions can be downloaded from <http://www.hp.com/go/designjet>.
- 3 Ensure that Color Calibration is turned on (Setup Menu/Configuration Menu/Color calibration/On).
- 4 Load both Printers with similar paper types.
- 5 Ensure that the Paper Type setting on the front panel corresponds to the paper that is loaded.
- 6 With the HP-GL/2 driver for the HP Designjet 4000 Printer series, select the Color tab, and set the **Color Matching Method** to **sRGB**.
- 7 With the HP-GL/2 driver for the HP Designjet 1000 series, select the Options tab, then **Manual Color > Color Control > Match Screen**. You should also select the Paper Size tab, then **Paper Type**, and select an Enhanced Colors paper type.

### Printing the same HP-GL/2 file

The situation is that you have produced an HP-GL/2 file (also known as a PLT file) using the HP-GL/2 driver installed for one printer, and you intend to send the same file to both printers.

- 1 Ensure that both printers have been updated with the latest firmware version.
- 2 Ensure that Color Calibration is turned on (Setup Menu/Configuration Menu/Color calibration/On).
- 3 Load both Printers with similar paper types.
- 4 Ensure that the Paper Type setting on the front panel corresponds to the paper that is loaded.
- 5 If you have an HP-GL/2 file produced for an HP Designjet 1000 Printer series and you want to print it on an HP Designjet 4000 Printer series, proceed as follows using the Embedded Web Server or the front panel:
  - Using the Embedded Web Server: in the Color Management section of the Submit Job page, set the **Input Profiles: RGB** to **None (Native)**.
  - Using the front panel: Enter the **Setup Menu**, then **Printing defaults menu > Color Options > RGB Input Profile: None (Native)**.

For other HP Designjet Printers, set both printers to match the screen colors (**sRGB** if selectable), as when printing with separate HP-GL/2 drivers.

## Problems with Image Clipping

This normally indicates a discrepancy between the actual printable area on the loaded paper and the printable area as understood by the software.

- Check the actual printable area for the paper size that is loaded.  
printable area = paper size – margins  
The Windows HP-GL/2 driver displays the printable area in the Paper/Quality tab.
- Check what the software understands to be the printable area (which it may call "printing area" or "imageable area"). For example, some software applications assume standard printable areas that are larger than those used in this Printer.
- If a very long image needs to be printed on a roll, check that the software is capable of printing an image of that size.
- Check that the orientation of the paper is the same as that assumed by the software. The front-panel **Printing defaults menu > Paper options > Rotate** option changes both the orientation of a print and the orientation of the page. It is possible that a rotated image on a roll may be slightly clipped in order to retain the correct page size.
- The page may have been rotated from portrait to landscape on a paper size that is not wide enough.
- If necessary, change the printable area in the software.

### Other Possible Explanation

Some applications, such as Adobe Photoshop, Adobe Illustrator, and CorelDRAW, use an internal 16-bit coordinate system which means that they cannot handle an image of more than 32,768 pixels. If you try to print an image larger than this from these applications, the bottom of the image will be clipped. In this case, the only way to print the whole image is to reduce the resolution so that the whole image requires fewer than 32,768 pixels. The HP-GL/2 printer driver contains an option called **Compatibility with 16-bit applications**, which can be used to reduce the resolution of such images automatically. This option can be found by clicking the Troubleshooting button in the driver's Services tab.

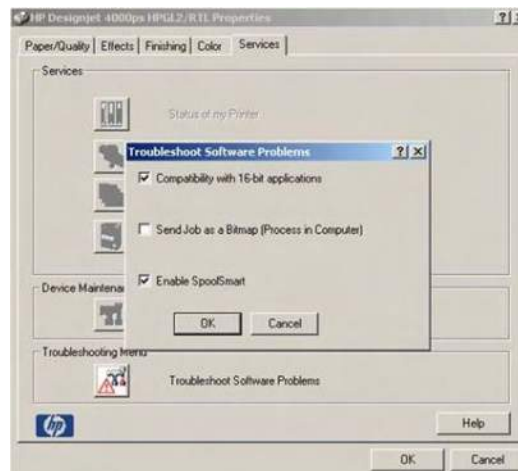

## Image is Completely Blank

If a file is sent to the Printer and the image comes out completely blank, this is probably because the incorrect Graphic Language has been selected. Try the following to resolve the problem:

- 1 If the Front Panel **graphic language** setting is set to **Automatic**, try choosing a setting specific to the current requirement (e.g. Select **PostScript** for a PostScript file).
- 2 Send the file again to see if the problem is now resolved.

**Once the file has been printed, make sure you reset the graphic language back to Automatic (Setup Menu/Printing Defaults Menu/Graphic Language).**

If the problem continues, then try the following:

- 1 If the Front Panel **graphic language** setting is **not** set to **Automatic**, then set it to Automatic so that the Printer can determine which type file it is receiving.
- 2 Select **HP-GL/2** if PostScript files are not being used and if image position problems or timing problems have been experienced in the past.
- 3 Select TIFF, JPEG, PDF or CALS G4 only if the file of the appropriate type is sent directly to the Printer without going through a Printer driver. This is normally done only from the Embedded Web Server (EWS), in which case the language setting is done by the EWS and does not need to be done manually.

**The PS and PDF options are available in the HP Designjet 4000ps but not in the HP Designjet 4000.**

## Output Only Contains a Partial Print

If the output that was expected only contains a partial image, then try the following to resolve the problem:

- 1 Was the **Cancel** key pressed before all the data was received by the Printer? If so, send the file again and make sure that the **Cancel** key is not pressed.
- 2 The **I/O Timeout** setting may be too short. Increase the I/O timeout setting (Setup Menu/I/O Setup/IO Timeout) and then send the file again.
- 3 There might be a problem between the Printer and Computer. Check the cable between the computer and the Printer to make sure it is not damaged and is connected correctly.
- 4 Make sure that the software settings are correct for the current page size (e.g. long-axis prints).
- 5 If network software is being used, make sure it has not timed out.

### Image is in One Portion of the Printing Area

If the output that was expected only contains an image in one portion of the Print Area, then try the following to resolve the problem:

- 1 Check to see if a too small a page size has been selected in the application.
- 2 Check to see if the application is set to print the image in only one portion of the page.
- 3 If the problem continues, then the cause could be software-printer incompatibility:
  - Check to see if the software is configured correctly for the Printer.
  - Try changing the Graphic Language through the Front Panel (Setup Menu/Printing Defaults Menu/Graphic Language).
  - Refer to the Assembly and Setup Poster and the driver documentation.

### Image is Unexpectedly Rotated (PostScript Driver)

If the output that was expected contains an image that was unexpectedly rotated, then try the following to resolve the problem:

- 1 Check the **rotate** option through the Front Panel (Setup Menu/Printing Defaults Menu/Paper Options/Rotate) to make sure the rotate option has not been selected.
- 2 For non-PostScript files, if **Nesting** is **On**, the pages might be automatically rotated in order to save paper.
- 3 Check also the following options to see if the rotate option has been activated by mistake:
  - Windows Driver - **Finishing** tab ? **Rotate by 90 degrees**.
  - Mac OS Driver - **Finishing** panel ? **Rotate by 90 degrees**.
  - Embedded Web Server - Select **Submit Job** ? **Rotate**.

## Print is Distorted or Unintelligible

If the output that was expected is distorted or unintelligible, then try the following to resolve the problem:

- 1 There might be a problem between the Printer and Computer. Check the cable between the computer and the Printer to make sure it is not damaged and is connected correctly.
- 2 If the Front Panel **graphic language** setting is set to **Automatic**, try choosing a setting specific to the current requirement (e.g. Select **PostScript** for a PostScript file).
- 3 Depending on the software, drivers and RIPs that are being used, there are different ways of solving this problem - refer to the relevant Vendor's User Documentation for further information.

## Print is a Mirror Image of the Original

If the output that was expected is a mirror image of the original image, then try the following to resolve the problem:

- 1 Check the **mirror** option through the Front Panel (Setup Menu/Printing Defaults Menu/Paper Options/Mirror) to make sure the rotate option has not been selected.
- 2 Check also the following options to see if the mirror option has been activated by mistake:
  - Windows Driver - **Finishing** tab ? **Mirror Image**.
  - Mac OS Driver - **Finishing** panel ? **Mirror Image**.
  - Embedded Web Server - Select **Submit Job** ? **Mirror**.

## One Image Overlaps Another on the Same Sheet

If the output that was expected contains an image that overlaps another on the same sheet, then try the following to resolve the problem:

- 1 The **I/O Timeout** setting may be too long. Decrease the I/O timeout setting (Setup Menu/I/O Setup/IO Timeout) and then send the file again.

## No Output from the Printer

If a file is sent to the Printer but no output is printed, then try the following to resolve the problem:

- 1** Check that the power cable is correctly connected and that the Printer is switched On. Check that all communication cables are correctly connected.
- 2** Strong Electromagnetic fields or electrical disturbances may be affecting the Printer. In this case, power Off the Printer and wait until the electromagnetic environment has returned to normal before powering On the Printer again.
- 3** Incorrect Graphic Language has been set through the Front Panel. Make sure that if a MAC OS is being used to print, the **graphic language** setting should be set to **Automatic** or **PostScript**.
- 4** Make sure the correct driver has been installed. The correct driver can be downloaded from <http://www.hp.com/go/designjet>.
- 5** If a Mac OS is being used with either FireWire or USB, the data encoding option may need to be changed.
  - a** Change the data encoding setting through the Front Panel (Setup Menu/Printing Defaults Menu/PS Options/Encoding/ASCII).
  - b** Then configure the application to send ASCII data.
- 6** The print job could be waiting for a timeout:
  - Check that the file has a proper file terminator. If not, then wait the specified I/O timeout period.
  - If Nesting is turned ON, the Printer may be waiting for the specified timeout before printing.
  - If using the Embedded Web Server, a print preview may have been requested. In this case, initiate the print through the Embedded Web Server.

## Pinchwheel Marks when using Glossy Media

### Description of problem

The Pinchwheels mark the glossy media and some waves can be seen in the printed images that have high density area fills. This happens when using HP Productivity Photo Gloss media and it can be seen especially at the beginning of the first print job after loading the media (the skew check routine moves the media backwards and forwards several times).

### Corrective Action

- 1** If an image is to be printed that has high density area fills, advance the media so that the problem is greatly reduced.
- 2** Reprint the image (the problem will be reduced).

## VLS in 1 Pass Printmodes

### Description of problem

In certain circumstances the lines are not straight when using 1 pass printmodes. There are several factors that explain why vertical line straightness (VLS) in 1 pass printmodes are above acceptability threshold:

- Printhead Alignment residual error.
- Printing on paper type different from the one used to perform the Printhead Alignment.
- Some level of theta Z coming from the stabilization area after a media load (approximately 3 meters of paper).

Shown below is an example of what you might see if you have this problem:

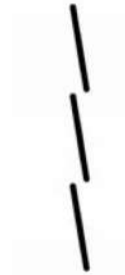

### Corrective Action

- 1** Check that the appropriate print quality settings are being used. Refer to Page 6-3 for further information on choosing the correct Print Quality settings.
- 2** Roll paper usually gives better vertical lines than a single sheet of the same type of paper. If sheet paper must be used, then it is recommended to use the **Best** print quality setting.
- 3** Try using a heavier paper type, such as HP Heavyweight Coated Paper or HP Productivity Gloss.
- 4** Align the Printheads (Ink Menu/Printheads/Align Printheads).

## VLS in First 3 Meters after a Media Load

### Description of problem

In order to ensure that the user can load the media into the Printer with an acceptable success rate, the Printer allows the media to be loaded with a certain level of skew. This initial skew gets automatically corrected as the media is advanced: there is a transition area where the media rotates until the skew gets corrected and the paper stabilizes. The media rotation in the transition zone is what actually creates the vertical line straightness problem.

### Corrective Action

- 1 Make sure that the media is loaded as straight as possible. Use the blue line of the Print Platen to align the edge of the media correctly.

**An alternative way of loading media is to align the media with the end of the overdrive. This way media waste will be minimized and it will also reduce media load problems.**

- 2 Check that the appropriate print quality settings are being used. Refer to Page 6-3 for further information on choosing the correct Print Quality settings.
- 3 Roll paper usually gives better vertical lines than a single sheet of the same type of paper. If sheet paper must be used, then it is recommended to use the **Best** print quality setting.
- 4 Try using a heavier paper type, such as HP Heavyweight Coated Paper or HP Productivity Gloss.
- 5 Align the Printheads (Ink Menu/Printheads/Align Printheads).

## Bubbles (Only occurs in Cyan, Magenta and Yellow)

### Description of problem

The bubbles problem is normally seen as banding (white lines) and the severity is quite different depending on the amount of nozzles out.

### Corrective Action

- 1 Check that the appropriate print quality settings are being used. Refer to Page 6-3 for further information on choosing the correct Print Quality settings.
- 2 Recover the Printheads (Ink Menu/Printheads/Recover Printheads).
- 3 Turn "Printhead Monitoring" to "Intensive" to guarantee consistent quality while using the **Best** print quality setting.
- 4 Replace the faulty Printhead.



## Black Printhead: Decap Problem

### Description of problem

When the Black Printhead does not fire any ink during one swath, but only prints at the end of the swath, a thin vertical line (a defect) can be seen:

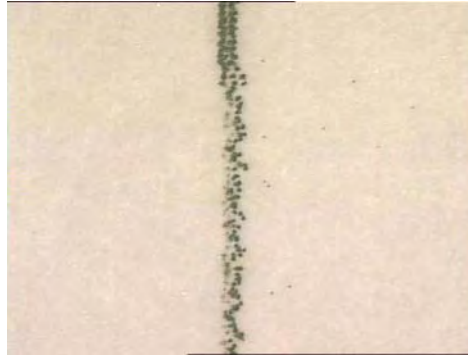

Some information to take into consideration:

- The part of the thin line which is before the black box is of much better quality compared to the part which has not been printed for at least the last 37.5 inches (95.3 cm).
- The longer the Black Printhead is not printing, the more visible the defect will be.
- The defect is not seen with thicker lines.
- If the Black Printhead is not printing at the beginning of the print (e.g. no black frame around the print), the defect can be worse. This specific defect is called "Inter Swath Decap".
- When the Black Printhead is printing at the beginning of the swath (e.g. when there is a black frame around the print), the specific decap defect is called "Intra Swath Decap".

### Corrective Action

- 1 Check that the Printer has the latest Firmware version. If not, update the Firmware to the latest version.
- 2 Try rotating the print by 90, 180 or 270 degrees.
- 3 Since this problem is only seen when printing thin lines, try to avoid printing thin lines whenever possible.
- 4 To decrease the probability of having the "Inter Swath Decap" issue, a black frame around the print should be added.
- 5 Switch to the **Best** print quality setting and turn Off the "Maximum Detail" option in the Driver.

## Paper Expansion - Paper Advance (PEPA)

### Description of problem

When printing high density area fills on a paper-based media, the media will expand. As the media expands, it can create "bandings" between each swath. The "banding" is mainly noticeable when printing high density area fills while using the **Fast** print quality setting and with the **optimized for drawings/text** setting activated.

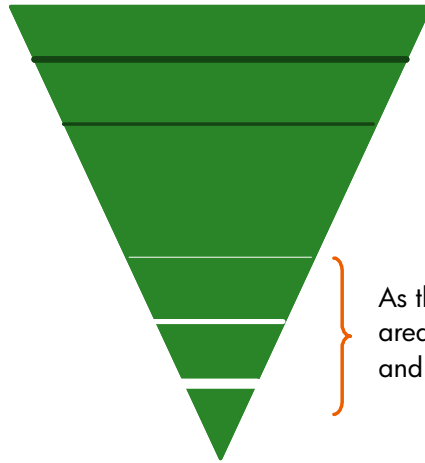

As the quantity of ink is higher in this area, the paper expands more and can cause dark banding.

As the quantity of ink is lower in this area, the paper does not expand more, and some white banding can appear.

### Corrective Action

- 1 If the image has been printed using the **Fast** print quality setting, then reprint it using the **Normal** or **Best** print quality setting and activate the **optimized for images** option.
- 2 Try using a heavier paper type, such as HP Heavyweight Coated Paper or HP Productivity Gloss.
- 3 Check that the environmental conditions (temperature, humidity) are within the temperature/humidity range as specified for the Printer (refer to the User's Guide for further information).

**Do NOT perform the Paper Advance Calibration as this will recenter the actual advance factor BUT won't prevent the differential banding due to paper expansion.**

## Bidirectional Offset in Light Color Density Areas

### Description of problem

There seems to be a slight Bidirectional offset when printing light color density areas in lines or drawings. This happens when printing on Plain Paper using the **Fast** print quality setting with the "Maximum Detail" option switched Off.

Shown below is an example of what you might see if you have this problem:

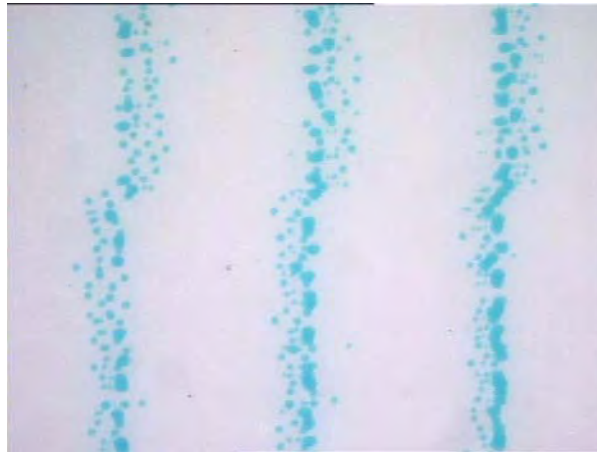

### Corrective Action

- 1 If the image has been printed using the **Fast** print quality setting, then reprint it using the **Normal** or **Best** print quality setting.
- 2 Avoid printing light density areas/lines, especially grays.
- 3 Turn On the "Maximum Detail" option in the Driver.

## Ink Contamination on Yellow Printhead

### Description of problem

In certain circumstances, the Yellow Printhead is cross-contaminated by aerosol coming from the Black Printhead. This occurs when the aerosol removal system in the Service Station ceases to work.

When this problem occurs you will actually see nozzles out and misdirected. In this situation Printhead Recovery will not help to resolve the problem since this is a permanent problem and eventually degrades the life of the Printhead.

### Corrective Action

- 1 Replace the Yellow Printhead and the Black Printhead Cleaner.

## Satellites in Black Lines

### Description of problem

In certain prints, black text and lines have a fuzzy or shadow effect. This problem is more likely to be seen when printing CAD data at high Carriage Speeds (when printing on **Plain** Paper using the fast print quality setting).

Shown below is an example of what you might see if you have this problem:

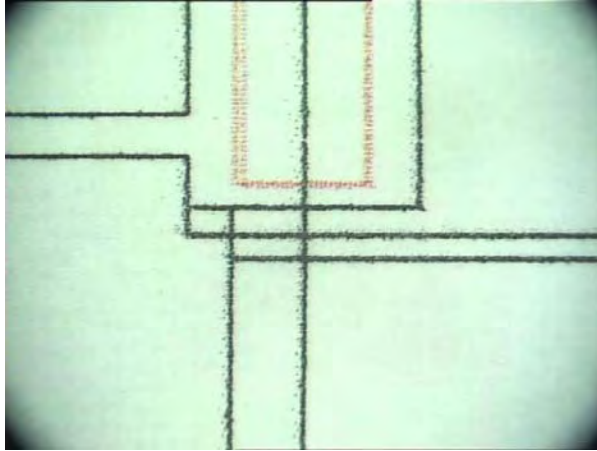

### Corrective Action

- 1 If the image has been printed using the **Fast** print quality setting, then reprint it using the **Normal** or **Best** print quality setting.
- 2 If the image needs to be printed using the **Fast** print quality setting, then try turning On the "Maximum Detail" option in the Driver.

# Parts and Diagrams

# 7

Printer Support 7-2  
Center Covers 7-4  
Electronics Module 7-6  
Right Hand Cover 7-8  
Left Hand Cover 7-10  
Right Hand Assemblies 7-12  
Left Hand Assemblies 7-14  
Carriage Assembly 7-16  
Scan-Axis Assemblies 7-18  
Drive Roller and Media-Axis Motor 7-20  
Paper Path Assemblies 7-22  
Center Guide and Pinchwheel Assembly 7-24  
Media Entry Assemblies 7-26  
Miscellaneous Parts 7-28

## Printer Support

Printer Support			
Reference on Drawing	HP Part Number	Quantity	Description/Comments
1	Q1271-60454	2	Foot Assembly
2	Q1271-60455	2	Legs Assembly
3	Q1271-60456	1	X-Brace Assembly
4	Q1271-60457	1	Bin Assembly
-	Q1271-60458	1	Hardware Kit (Includes screws for Legs Assembly)
5	Q1271-60459	2	Leg Cover

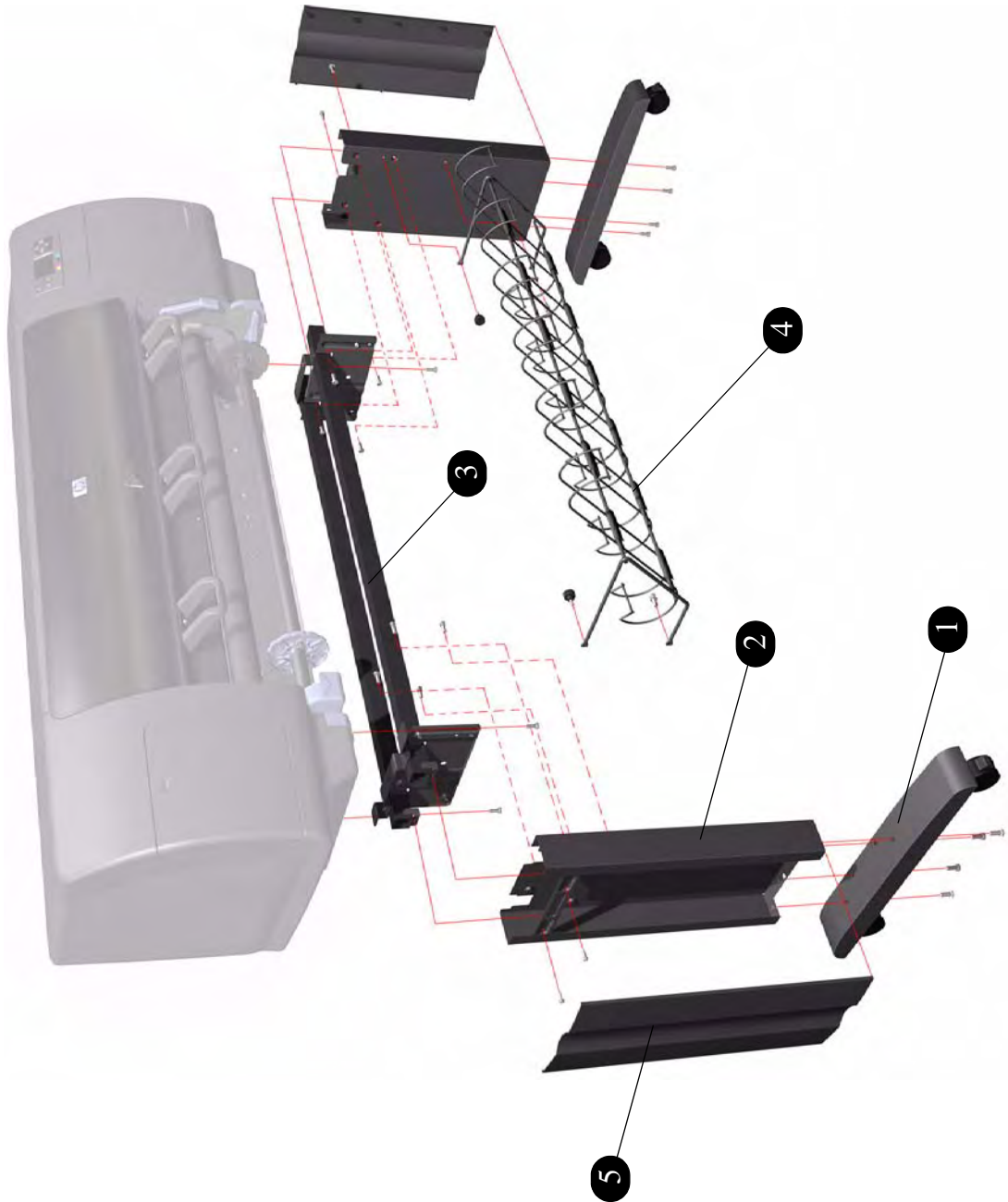
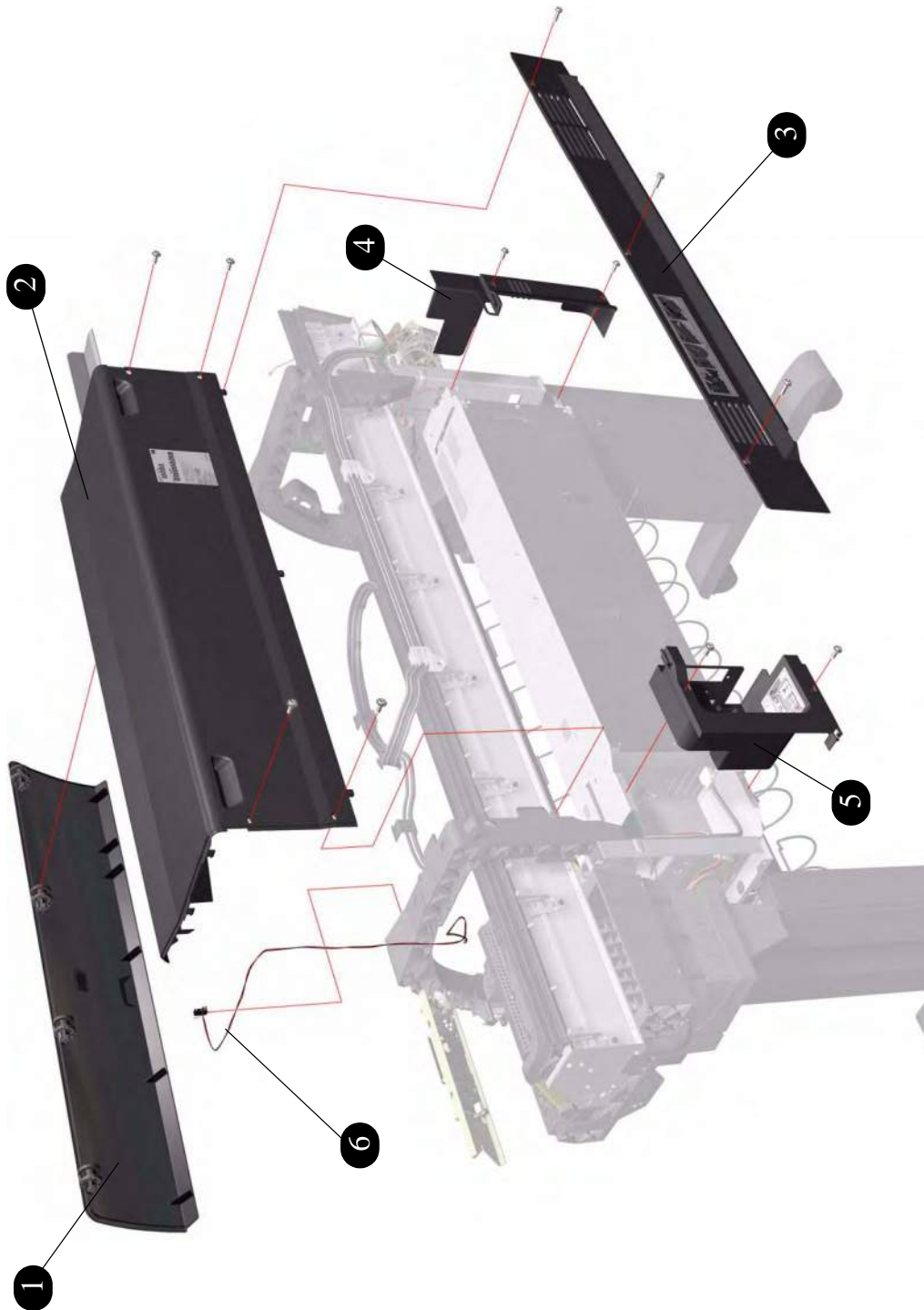

**Figure 1: Printer Support**

## Center Covers

Center Covers			
Reference on Drawing	HP Part Number	Quantity	Description/Comments
1	Q1273-60057	1	Window
2	Q1273-60052	1	Top Cover
3	Q1273-60107	1	Rear Door
4	Q1273-60105	1	Left Connector Cover
5	Q1273-60106	1	Right Connector Cover
6	Q1273-60072	1	Window Sensor

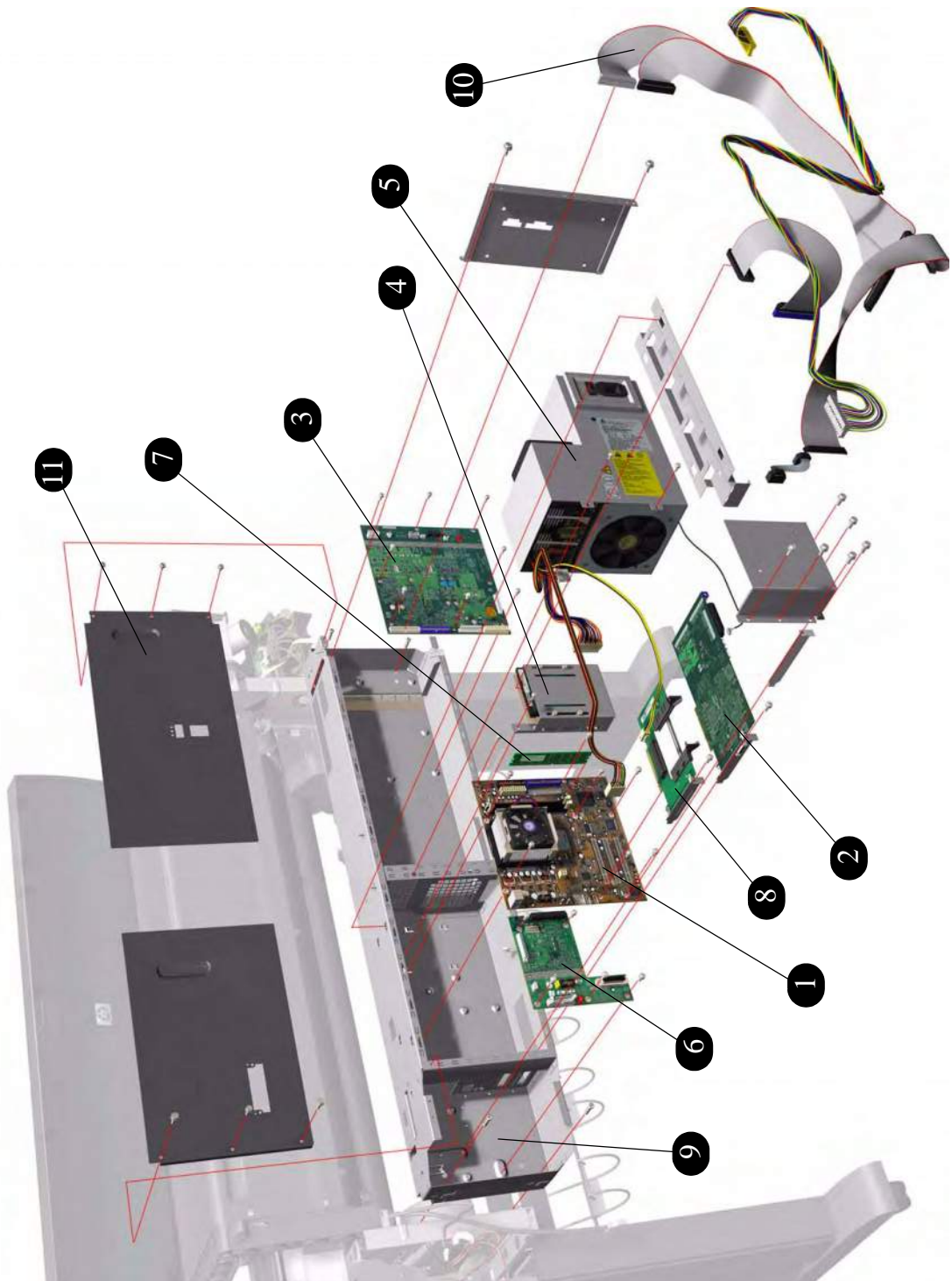



**Figure 2: Center Covers**

## Electronics Module

Electronics Module			
Reference on Drawing	HP Part Number	Quantity	Description/Comments
1	Q1273-60043	1	Main PCA Formatter (Includes Processor & Heatsink)
	Q1273-69043	1	Main PCA Formatter (Includes Processor & Heatsink) - <b>Refurbished</b>
2	Q1273-60074	1	Gamut PCI PCA
	Q1273-69074	1	Gamut PCI PCA - <b>Refurbished</b>
3	Q1273-60055	1	Printmech PCA
	Q1273-69055	1	Printmech PCA - <b>Refurbished</b>
4	Q1273-60044	1	Hard Disk Drive (Includes Holder and screws)
	Q1273-69044	1	Hard Disk Drive (Includes Holder and screws) - <b>Refurbished</b>
5	Q1273-60056	1	Power Supply Unit
	Q1273-69056	1	Power Supply Unit - <b>Refurbished</b>
6	Q1273-60075	1	Interconnect PCA
7	Q1273-60078	1	Memory Module 256MB
8	Q1273-60077	1	EIO2PCI Interface
9	Q1273-60083	1	Empty Electronics Module Assembly
10	Q1273-60076	1	Electronics Module Cables Kit
11	Q1273-60065	1	Electronics Module Metal Parts Kit
12	Q5680-60001	1	PCI USB PCA
13	Q5679-60001	1	Gigabit Ethernet PCI Card



**Figure 3: Electronics Module**

## Right Hand Cover

Right Hand Cover			
Reference on Drawing	HP Part Number	Quantity	Description/Comments
1	Q1273-60054	1	Right Hand Cover (without Door)
2	Q1273-60095	1	Right Hand Trim
3	Q1273-60045	1	Front Panel (Includes Cable)
4	Q1273-60101	1	Front Panel Bezel
5	Q1273-60090	1	Printhead Cleaner Access Door (for hp designjet 4000)
	Q1273-60129	1	Printhead Cleaner Access Door (for hp designjet 4000ps) (includes Adobe and Pantone Logo)
6	Q1273-60092	1	Push-Push Mechanism
7	Q1273-60088	1	Quick Reference Guide Holder

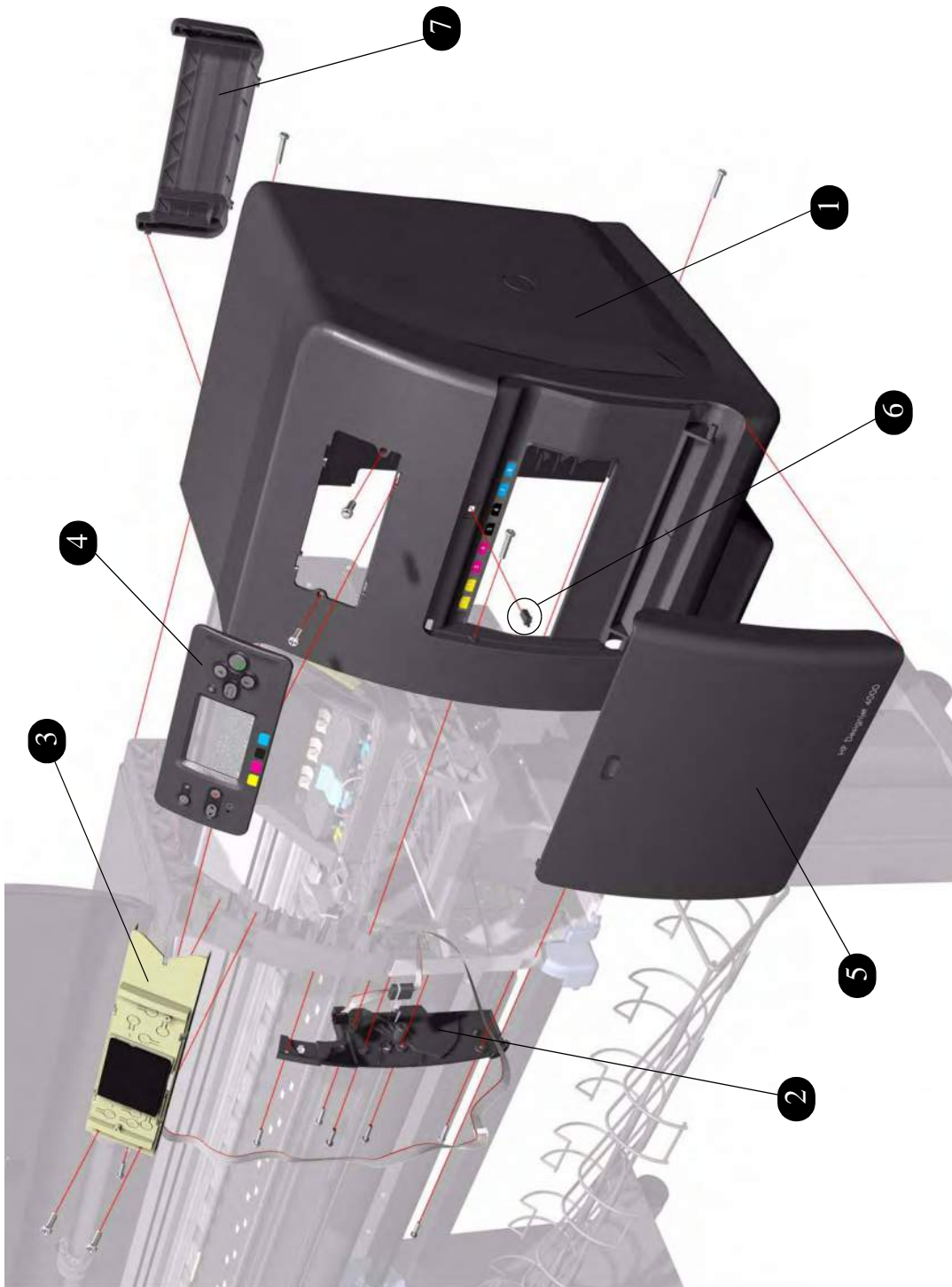

**Figure 4: Right Hand Cover**

## Left Hand Cover

Left Hand Cover			
Reference on Drawing	HP Part Number	Quantity	Description/Comments
1	Q1273-60053	1	Left Hand Cover (without Door)
2	Q1273-60096	1	Left Hand Trim
3	Q1273-60091	1	Cartridge Access Door
4	Q1273-60092	1	Push-Push Mechanism

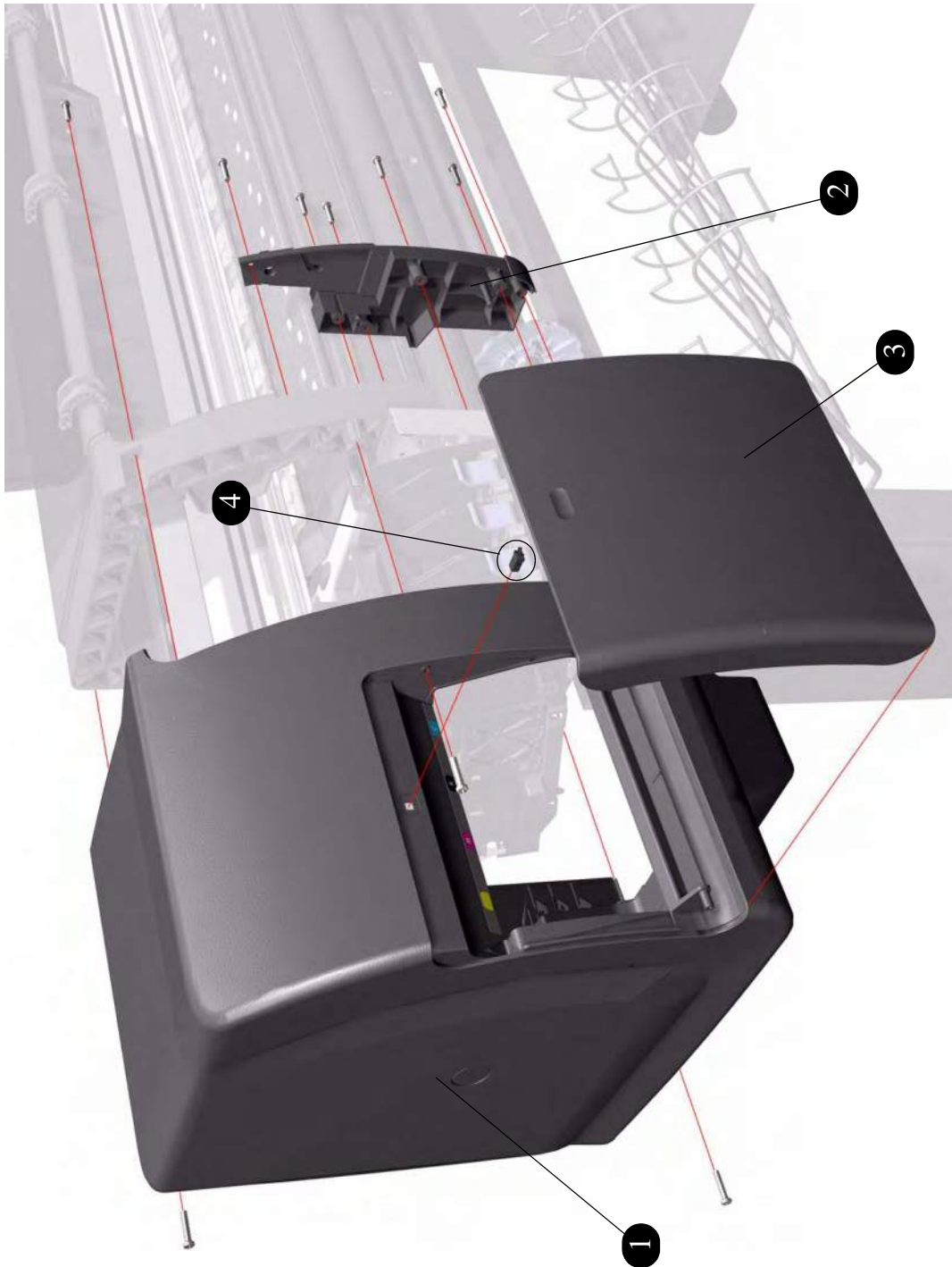
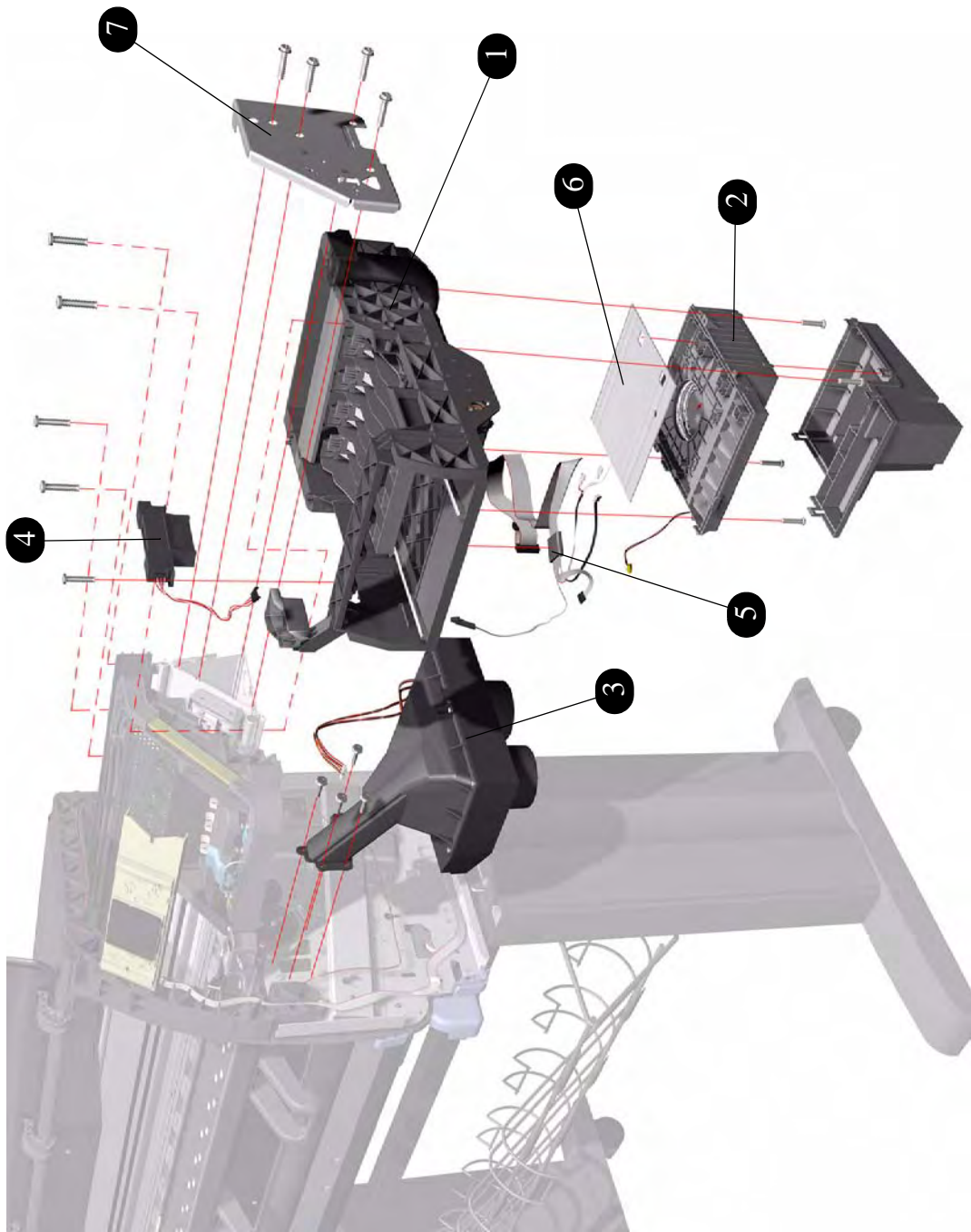

**Figure 5: Left Hand Cover**

## Right Hand Assemblies

Right Hand Assemblies			
Reference on Drawing	HP Part Number	Quantity	Description/Comments
1	Q1273-60046	1	Service Station (Includes Drop Detector)
2	Q1273-60047	1	Aerosol Fan Assembly
3	Q1273-60048	1	Vacuum Fan Assembly
4	Q1273-60066	1	Drop Detector
5	Q1273-60067	1	Service Station Cable (Includes Printhead Cleaner Door Switch)
6	Q1273-60084	1	Aerosol Filter
7	Q1273-60086	1	Right Bracket

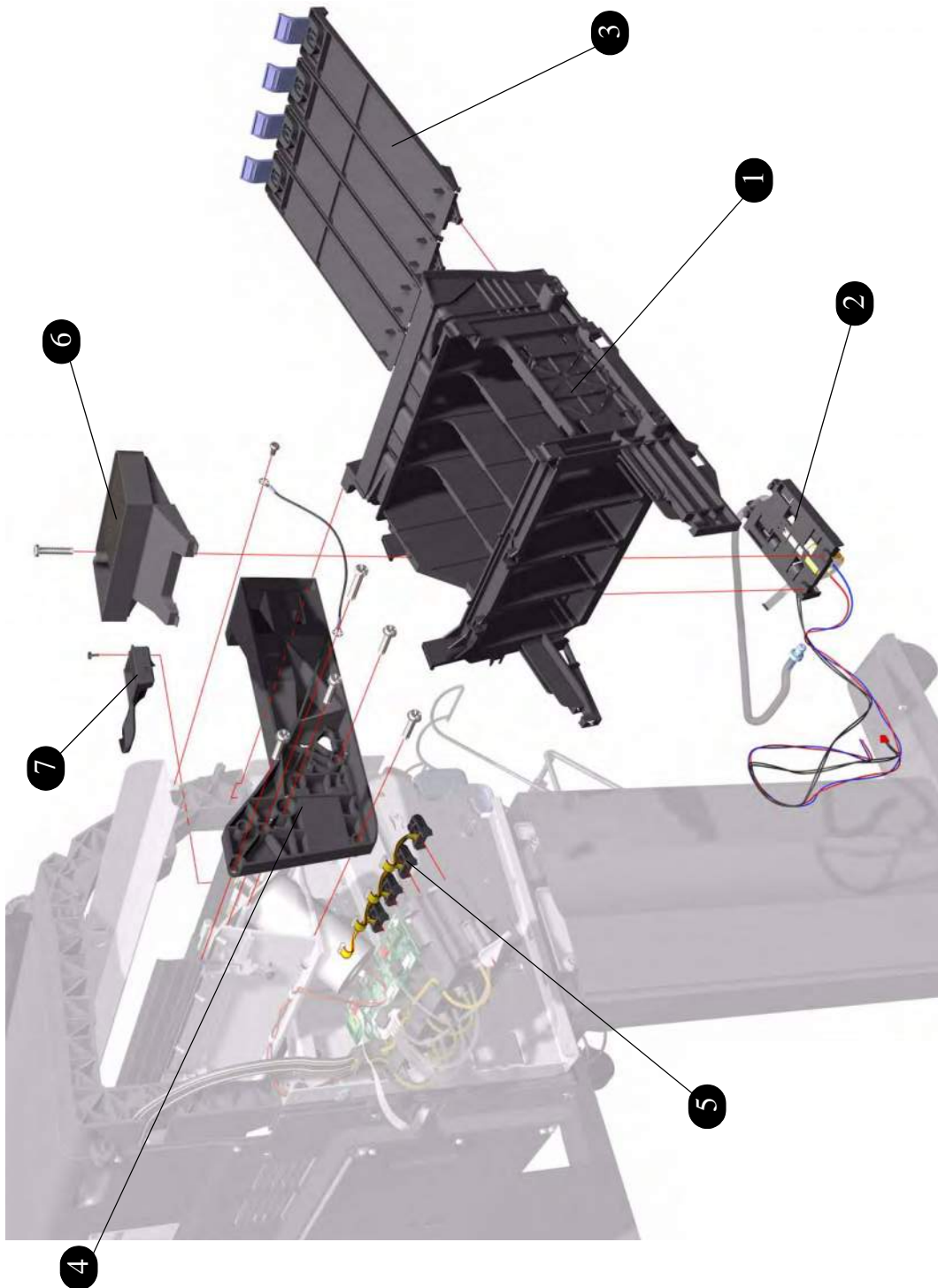



**Figure 6: Right Hand Assemblies**

## Left Hand Assemblies

Left Hand Assemblies			
Reference on Drawing	HP Part Number	Quantity	Description/Comments
1	Q1273-60049	1	Ink Supply Station (without APS)
2	Q1273-60068	1	Air Pressurization Pump (APS)
3	Q1273-60102	4	Cartridge Trays
4	Q1273-60085	1	Left Bracket
5	Q1273-60117	1	ISS to Cartridge Cable
6	Q1273-60099	1	Most Left Spittoons
7	Q1273-60100	1	Middle Left Spittoons



**Figure 7: Left Hand Assemblies**

## Carriage Assembly

Carriage Assembly			
Reference on Drawing	HP Part Number	Quantity	Description/Comments
1	Q1273-60051	1	Carriage Assembly (does not include Cutter, Carriage PCA, Encoder and Line Sensors)
2	Q1273-60062	1	Cutter Assembly
3	Q1273-60063	1	Line Sensor
4	-	1	Encoder Sensor (this sensor is included within the Encoder Strip and Encoder Sensor Kit, pn Q1273-60070)
5	Q1273-60111	1	Setup Printhead Kit
6	Q1273-60115	1	Carriage Flex Cables
7	Q1273-60116	1	Carriage PCA
	Q1273-69116	1	Carriage PCA - <b>Refurbished</b>
6	Q1273-60137	1	Carriage Stopper (includes Carriage Stopper Screw and Media-Axis Motor Bracket)
-	Q1271-60420	1	GW Maintenance Kit Generic

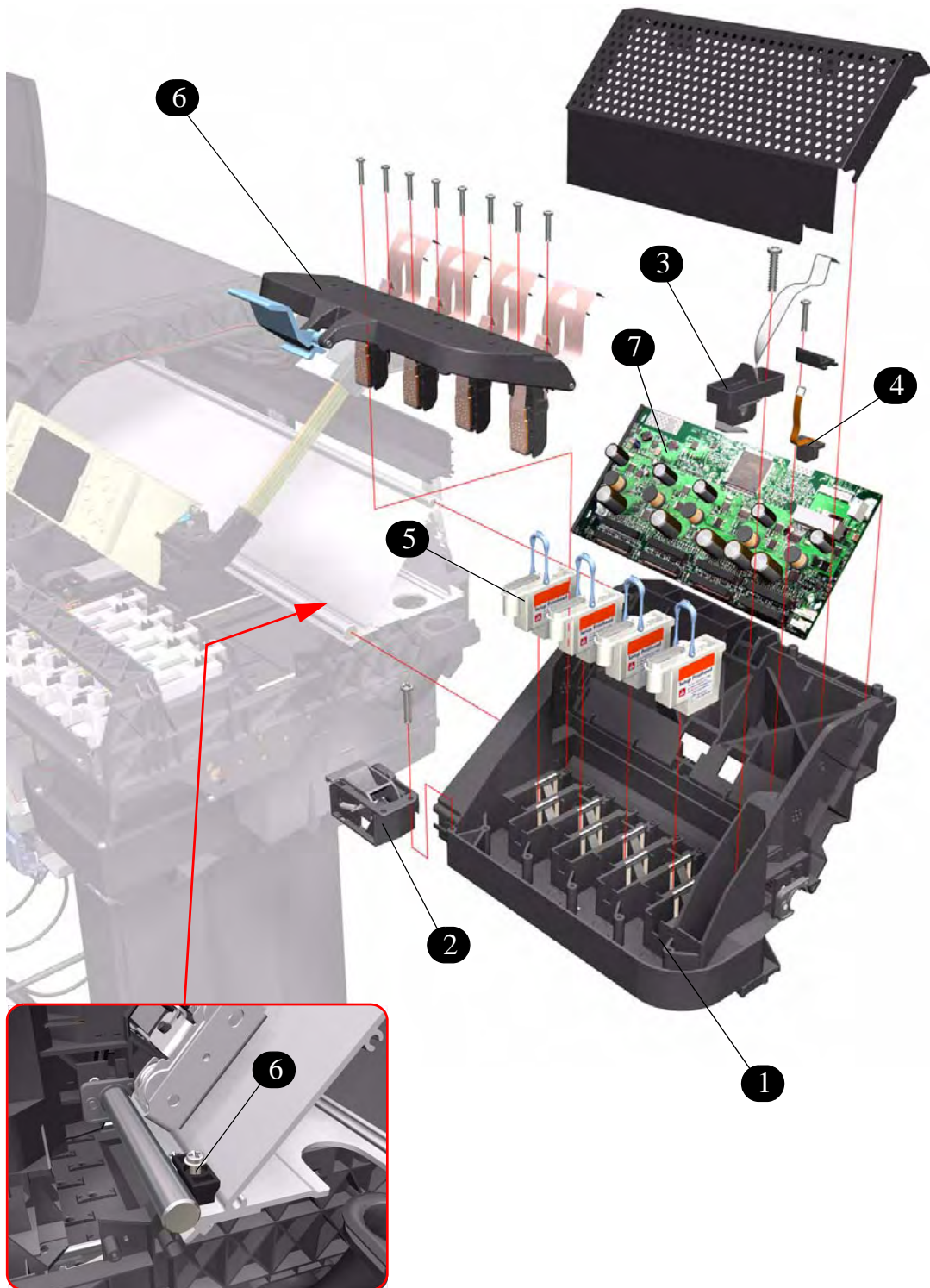

**Figure 8: Carriage Assembly**

## Scan-Axis Assemblies

Scan-Axis Assemblies			
Reference on Drawing	HP Part Number	Quantity	Description/Comments
1	Q1273-60050	1	Ink Supply Tubes and Trailing Cable
2	Q1273-60069	1	Belt and Tensioner Assembly
3	Q1273-60071	1	Scan-Axis Motor
4	Q1273-60070	1	Encoder Strip and Encoder Sensor Kit
5	Q1273-60108	5	Ink Supply Tubes Clips
6	Q1273-60112	2	Rear Tube Brackets

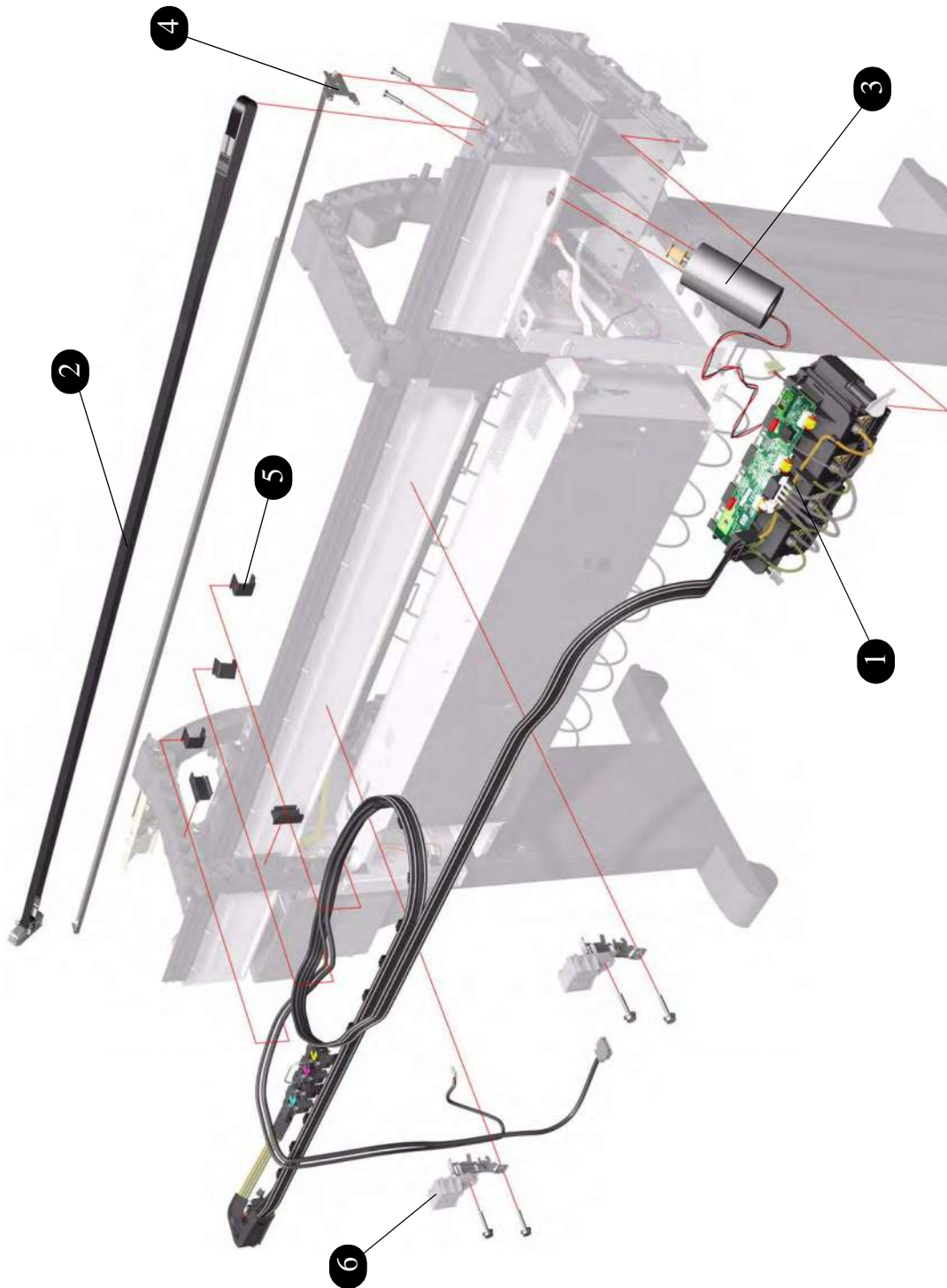
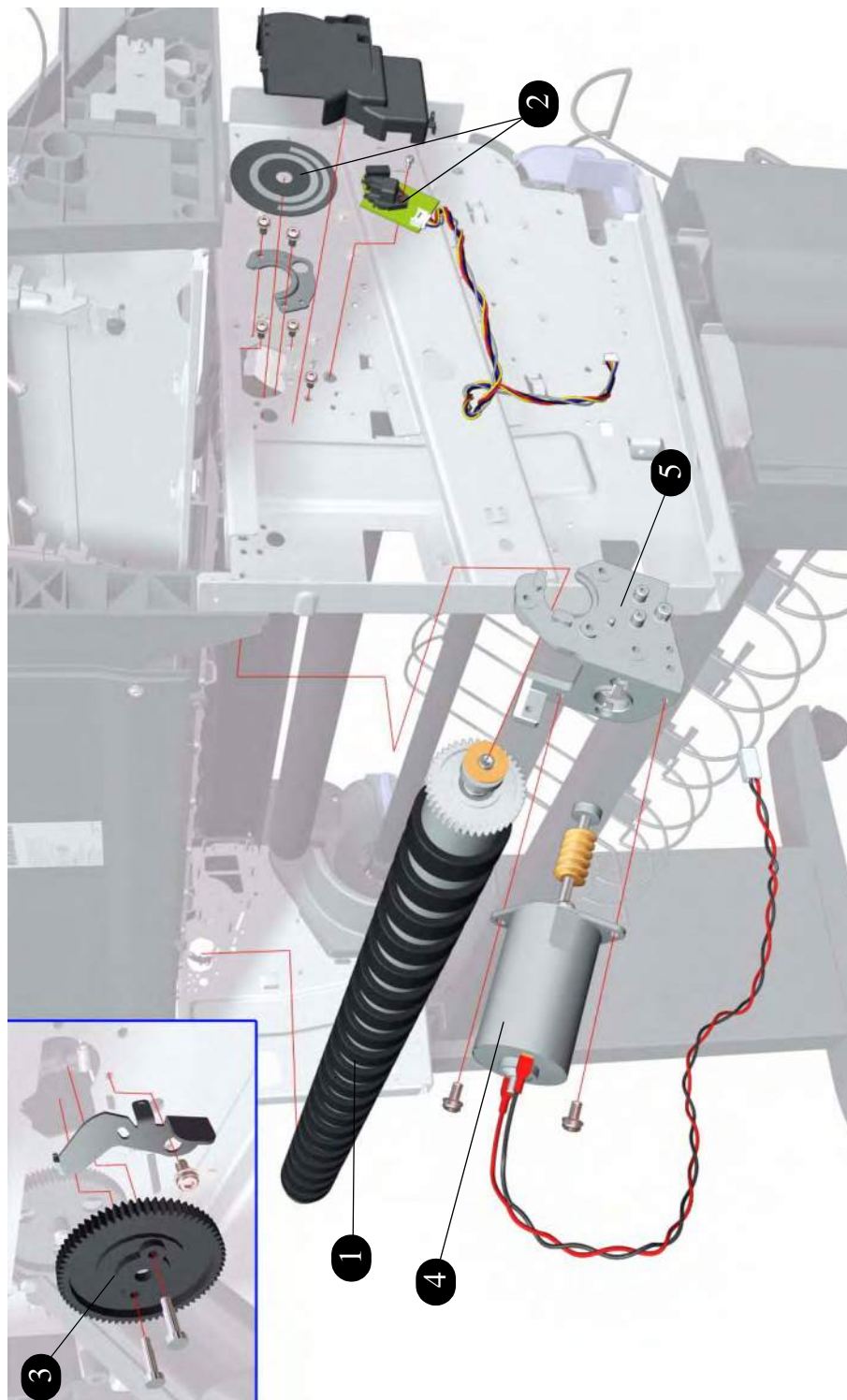

**Figure 9: Scan-Axis Assemblies**

## Drive Roller and Media-Axis Motor

Drive Roller and Media-Axis Motor			
Reference on Drawing	HP Part Number	Quantity	Description/Comments
1	Q1273-60039	1	Drive Roller
2	Q1273-60094	1	Drive Roller Encoder Kit
3	Q1273-60087	1	Gears and Drive Roller Brake Kit
4	Q1273-60037	1	Media-Axis Motor
5	Q1273-60137	1	Carriage Stopper (includes Carriage Stopper Screw and Media-Axis Motor Bracket)

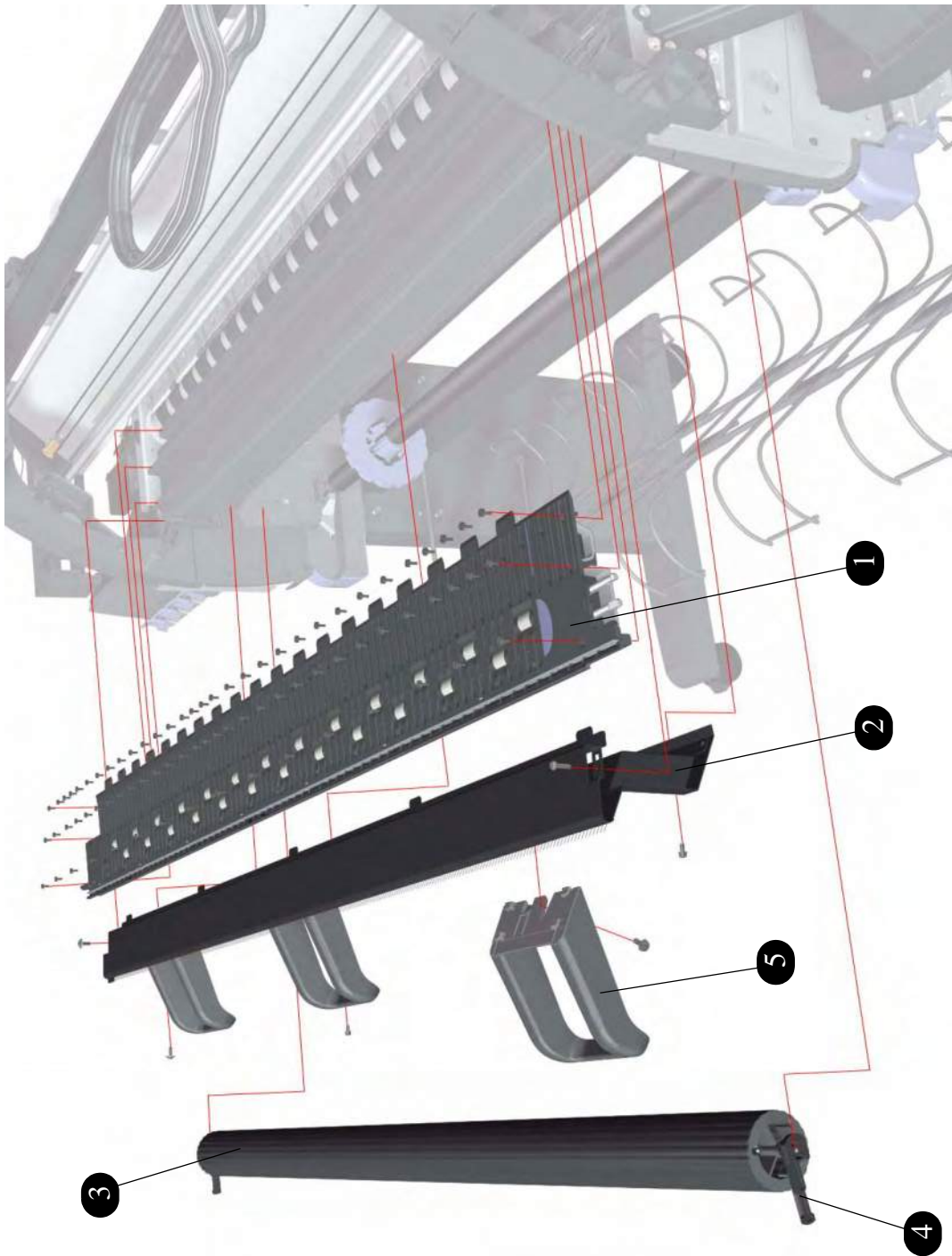



**Figure 10: Drive Roller and Media-Axis Motor**

## Paper Path Assemblies

Paper Path Assemblies			
Reference on Drawing	HP Part Number	Quantity	Description/Comments
1	Q1273-60041	1	Center Platen
2	Q1273-60060	1	Front Platen
3	Q1273-60058	1	Input Roller
4	Q1273-60103	2	Input Roller Levers
5	Q1273-60073	1	Media Deflectors Kit



**Figure 11: Paper Path Assemblies**

## Center Guide and Pinchwheel Assembly

Center Guide and Pinchwheel Assembly			
Reference on Drawing	HP Part Number	Quantity	Description/Comments
1	Q1273-60059	1	Center Guide
2	Q1273-60040	1	Complete Pinchwheels Assembly
-	Q1273-60104	1	Pinchwheels Kit (only contains the wheels)
3	Q1273-60082	1	Media Lever Sensor
4	Q1273-60093	1	Media Lever Assembly
5	Q1273-60079	1	Media Sensor

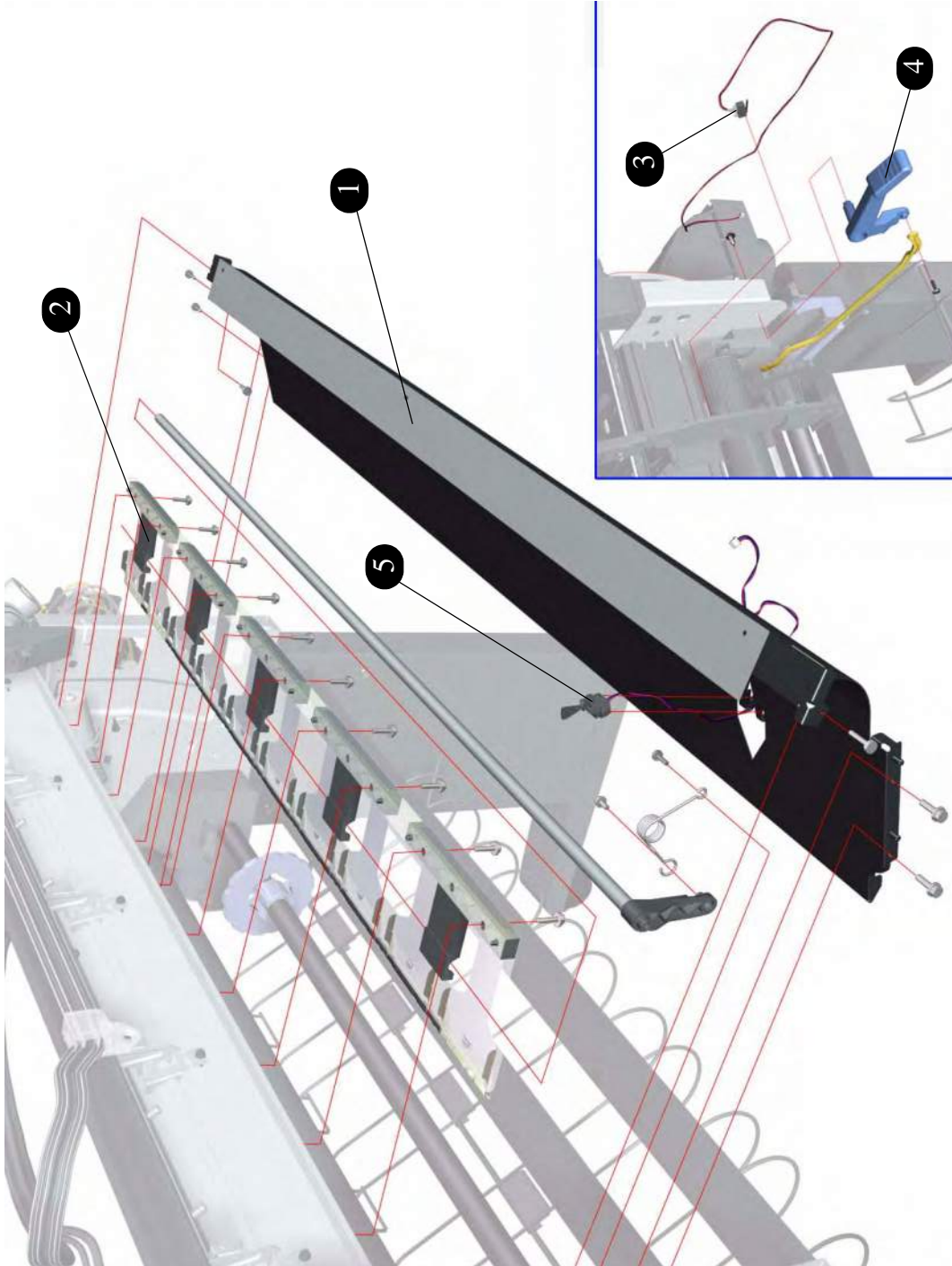

**Figure 12: Center Guide and Pinchwheel Assembly**

## Media Entry Assemblies

Media Entry Assemblies			
Reference on Drawing	HP Part Number	Quantity	Description/Comments
1	Q1273-60080	1	Left Roll Module Assembly
2	Q1273-60081	1	Right Roll Module Assembly (Also includes Right Spindle Lever p/n Q1273-60136)
3	Q1273-60121	1	42" Spindle (does NOT include Blue Hub)
4	C6090-60105	1	Blue Hub
5	C6090-60112	1	3" Spindle Adaptors
6	Q1273-60136	1	Right Spindle Lever

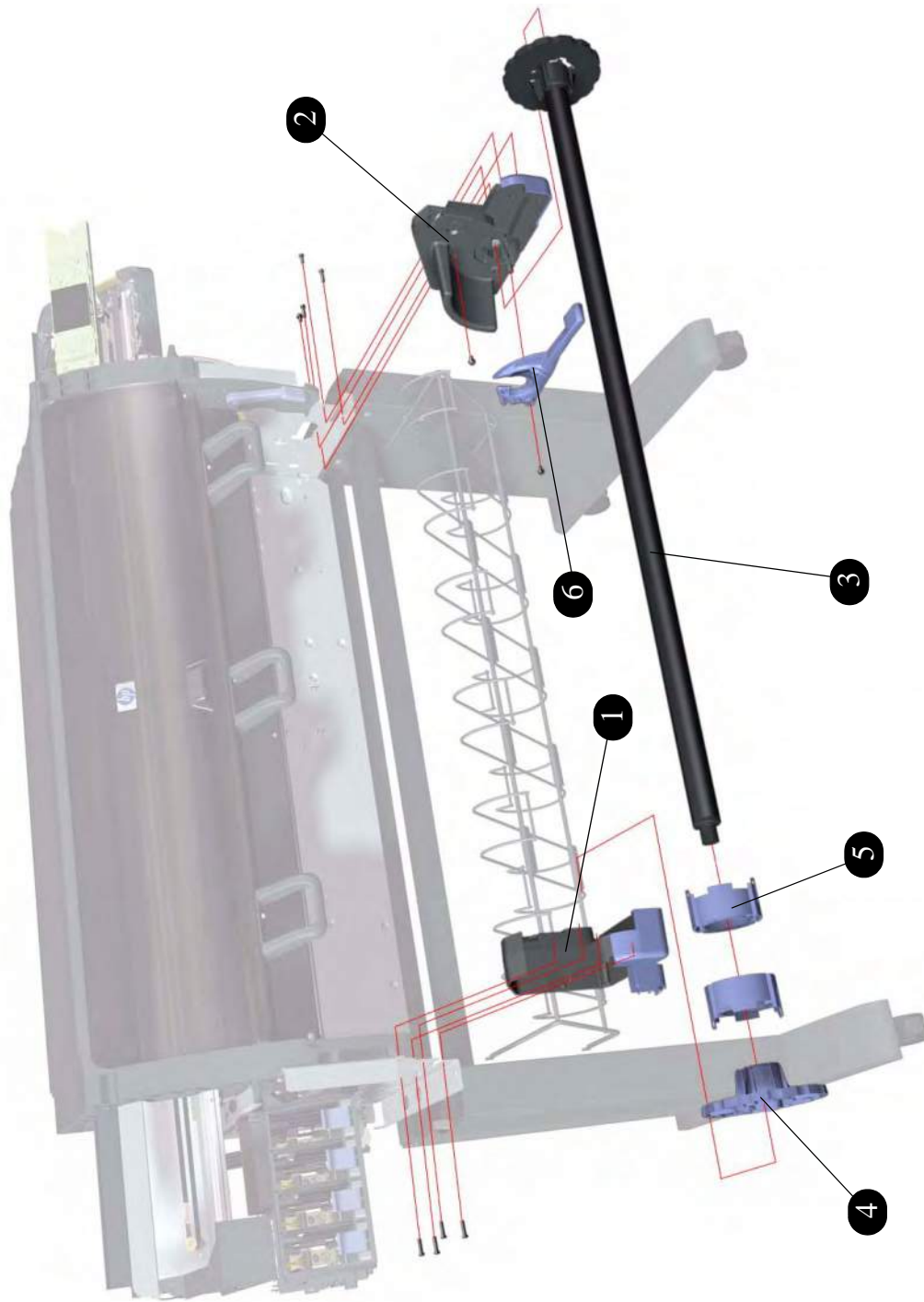
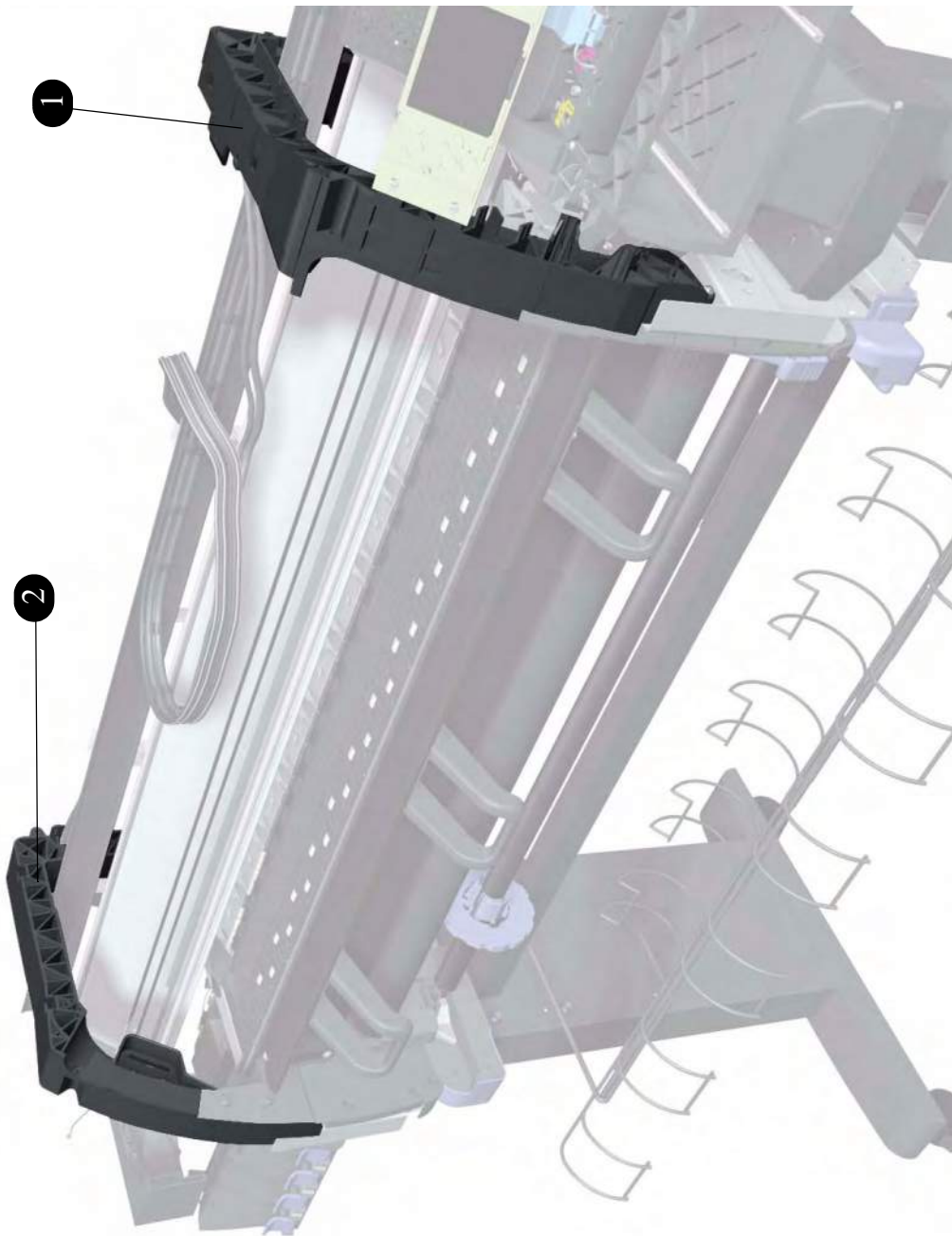

**Figure 13: Media Entry Assemblies**

## Miscellaneous Parts

Arc Assemblies			
Reference on Drawing	HP Part Number	Quantity	Description/Comments
1	Q1273-60097	1	Right Arc
2	Q1273-60098	1	Left Arc
-	Q1273-60061	1	Preventive Maintenance Kit (Includes Carriage Assembly (without Carriage PCA), Ink Supply Tubes and Trailing Cable, Scan-Axis Motor, Belt, Encoder Strip (includes Spring and Nut but does not include Encoder Reader), Most Left and Middle Left Spittoons), Scraper and the Media-Axis Drive Motor Brake (with the corresponding support Part)
-	Q1273-60125	1	2 Sheets of HP Productivity Gloss Media for Service Advance Calibration
-	Q1273-60130	1	Labels Kit (includes the Serial Number Label, I/O Connector Label and the Main PCA Cover Removal Label)
-	5961-3589	1	Power Cord (2.5 meters) for Australia
-	8120-6899	1	Power Cord (2.5 meters) for most European Countries, Korea, Indonesia, Portugal, Germany, Spain, France, Italy and Arabic Countries
-	8120-6898	1	Power Cord (2.5 meters) for Singapore, Arabic Countries and United Kingdom
-	8120-6896	1	Power Cord (2.5 meters) for India, South Africa
-	8121-0917	1	Power Cord (2.5 meters) for USA, Mexico, Canada, Taiwan, Japan and Arabic Countries
-	8121-0922	1	Power Cord (2.5 meters) for Brazil, Thailand and Philippines
-	5961-3590	1	Jumper Cord for Chili, Uruguay and Argentina
-	8120-6980	1	Power Cord (2.3 meters) for Chili and Uruguay (final cable that is connected to 5961-3590)
-	8120-6869	1	Power Cord (2.3 meters) for Argentina (final cable that is connected to 5961-3590)
-	5961-3588	1	Power Cord (2.5 meters) for China





**Figure 14: Arc Assemblies**



# Removal and Installation

# 8

Introduction	8-2
Screw Types	8-3
Window	8-4
Right Cover	8-6
Left Cover	8-9
Top Cover	8-11
Rear Door	8-16
Right Connector Cover	8-18
Left Connector Cover	8-19
Front Panel	8-20
Service Station	8-23
Vacuum Fan	8-27
Aerosol Fan	8-29
Drop Detector	8-31
Ink Supply Tubes and Trailing Cable	8-33
ISS to Cartridge Cables	8-38
Cutter Assembly	8-39
Ink Supply Station (ISS)	8-40
APS Assembly	8-42
Most Left Spittoons	8-43
Middle Left Spittoons	8-44
Encoder Strip and Encoder Sensor	8-45
Carriage PCA	8-48
Carriage Flex Cables	8-51
Carriage Assembly	8-53
Belt Assembly	8-58
Scan-Axis Motor	8-59
Media-Axis Motor	8-62
Interconnect PCA	8-64
EIO to PCA Interface Card	8-67
Gamut PCI PCA	8-69
Memory Module	8-72
Main PCA Formatter	8-74
Hard Disk Drive (HDD)	8-76
Power Supply Unit (PSU)	8-78
PrintMech PCA	8-84
Formatter Battery	8-87
Line Sensor Assembly	8-89
Media Deflector	8-91
Front Platen	8-92
Center Platen	8-94
Cartridge Trays	8-98
Input Roller	8-99
Push-Push Mechanism	8-100
Media Sensor	8-101
Encoder Disc and Sensor	8-103
Media Lever Assembly	8-106
Media Lever Sensor	8-108
Pinchwheel Assembly	8-111
Center Guide	8-115
Drive Roller	8-118
Right Rollfeed Module Assembly	8-125
Right Spindle Lever	8-128

## Introduction

*This chapter is a step by step guide to the removal and installation of the key components in the printer. You may find it useful to tick off the steps as they are performed. Use the illustration at each procedure to identify the parts referred to in the text.*

*The procedures appear in order of removal. So the whole machine can be stripped down by starting at the beginning of this chapter and working through the subsequent procedures.*

**Before using this chapter to remove and install a new component, always make sure that you have performed the relevant service test from Chapter 4. If the test passes you will not need to replace the component.**

## Safety Precautions

*Review WARNING and CAUTION symbols and instructions before you service the printer. Follow these warnings and cautions for your protection and to avoid damaging the printer.*

**Serious shock hazard leading to death or injury may result if you do not take the following precautions:**

**Ensure that the ac power outlet (mains) has a protective earth (ground) terminal.**

**Switch the plotter off, and disconnect it from the power source prior to performing any maintenance.**

**Prevent water or other liquids from running onto electrical components or circuits, or through openings in the module.**

## Electrostatic Discharge (ESD) Precautions

To prevent damage to the Printer circuits from high-voltage electrostatic discharge (ESD):

1. Do not wear clothing that is subject to static build-up.
2. Do not handle integrated circuits (ICs) in carpeted areas.
3. Do not remove an IC or a printed circuit assembly (PCA) from its conductive foam pad or conductive packaging until you are ready to install it.
4. Ground (earth) your body while disassembling and working on the Printer.
5. After removing a cover from the Printer, attach an earthing (ground) lead between the PCA common and earth ground. Touch all tools to earth ground to remove static charges before using them on the Printer.
6. After removing any PCA from the Printer, place it on a conductive foam pad or into its conductive packaging to prevent ESD damage to any ICs on the PCA.

## Required Tools

The following tools are required to disassemble and repair the Printer.

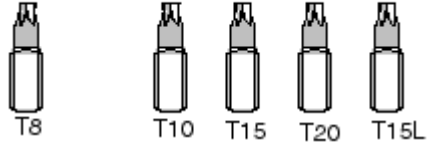

Small flat-blade screwdriver

## Screw Types

Type	Torx	Length (mm)	Head Type	Thread Type	Part Number
A	T-20	17	Pan	Taptite	0515-1743
B	T-20	10	Pan	Taptite	0515-2282
C	T-10	7.0	Pan	Machined	0515-4613
D	T-8	5.5	Pan	Taptite	0515-2850
E	T-15	-	Pan	-	C3180-20001
F	T-15	9.5	Pan	Plastite	0515-2981
G	T-15	12.7	Pan	Taptite	0624-0769
H	T-15	12.7	Pan	Taptite	0515-4706
I	T-10	8.0	Pan	Taptite	0515-2200
J	T-15	20	Pan	Plastite	0624-0771
K	T-8	9.5	Pan	Taptite	0624-0680
L	T-8	12.7	Pan	Taptite	0624-0768
M	T-20	-	Pan	-	0515-2521
N	T-20	35	Pan	Sheet Metal	C6071-20025
O	T-20	12.7	Pan	-	0624-1062
P	T-15	11.6	Pan	Machined	C2847-20018
Q	T-20	-	Pan	Taptite	0515-2916
R	T-15	-	Pan	Taptite	0515-1916

## Window

### Removal

**Switch off the product and remove the power cable.**

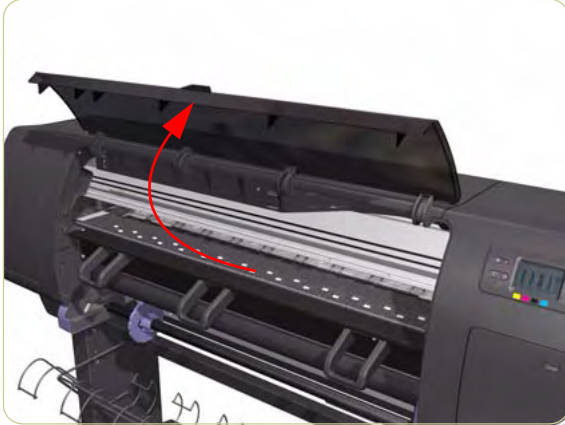

1. Open the Window.

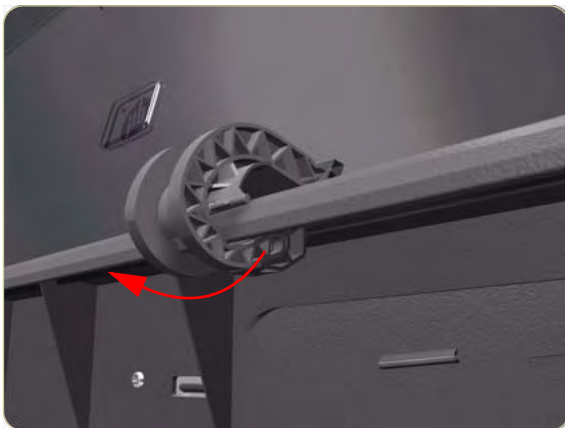

2. Unclip the Window hinges from the Top Cover.

**Since the hinges are very hard to unclip, it is recommended that you use a screwdriver or other tool to forcefully unclip the Window hinges from the Top Cover.**

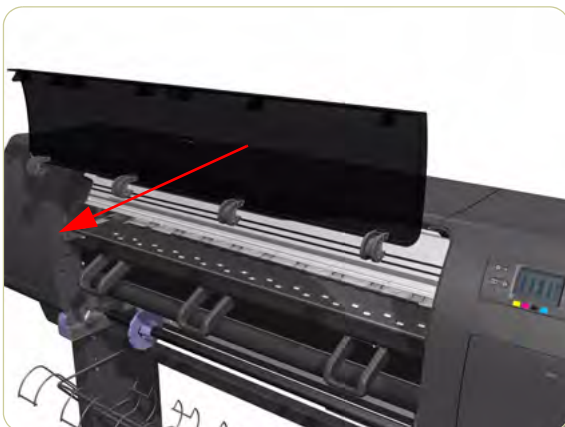

3. Remove the Window from the Printer.

## Installation of New Window

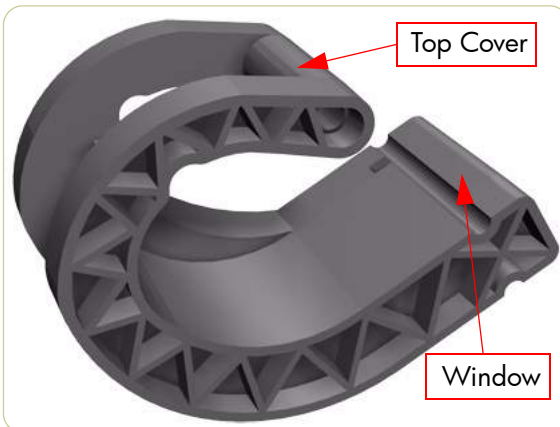

1. Identify the two ends of the Window Hinge (four in total) - one end is clipped to the Window and the other to the Top Cover.

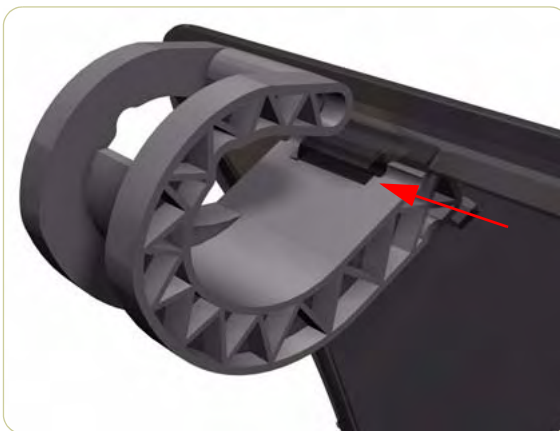

2. Slide the Window Hinges on to the Window.

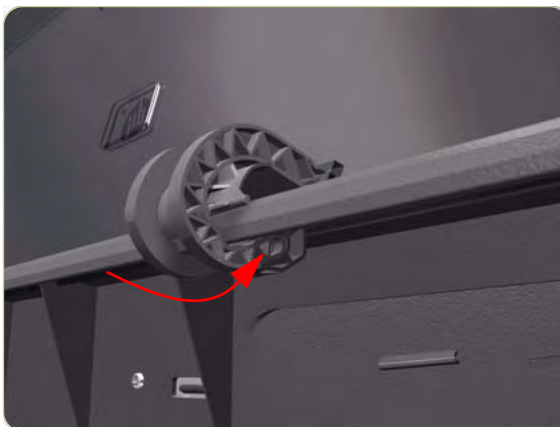

3. Clip the Window Hinges to the Top Cover.

**Since the hinges are very hard to clip, you will need to forcefully clip the Window hinges to the Top Cover.**

## Right Cover

### Removal

**Switch off the product and remove the power cable.**

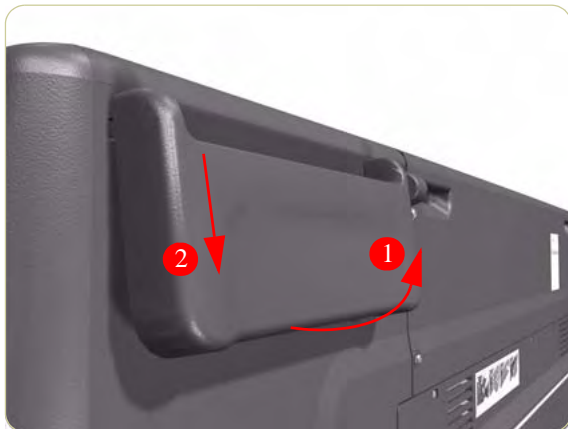

1. Unclip the Quick reference Guide Holder from the rear of the Printer.



2. Using a small flat-blade screwdriver, unclip the Front Panel Bezel from the Right Cover.



3. Remove the Front Panel Bezel from the Right Cover.



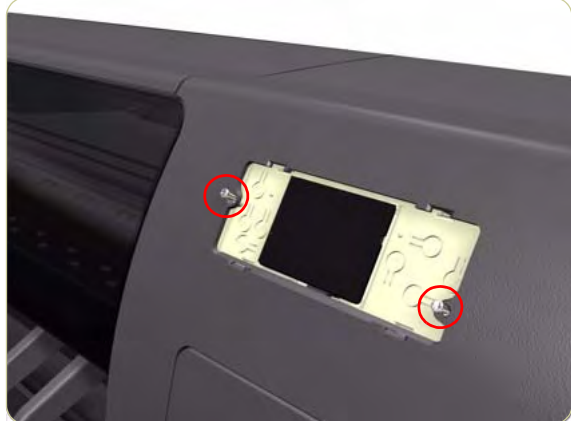

4. Remove two T-15 screws (**Type G**) that secure the Front Panel to the Right Cover.



5. Open the Printhead Cleaner Door.



6. Remove one T-15 screw (**Type J**) that secures the Right Cover.



7. Open the Window and remove two T-15 screws (**Type J**) that secure the Right Cover.

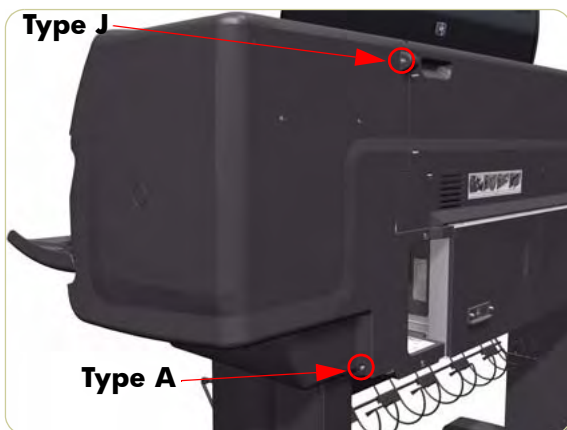

8. Remove one T-15 screw (**Type J**) and one T-20 screw (**Type A**) that secure the Right Cover from the rear of the Printer.



9. Remove the Right Cover from the Printer.

**When installing the Right Cover, make sure you leave the Printhead Cleaner Door open, otherwise you could damage the Printhead Cleaner Door Sensor.**

## Left Cover

### Removal

Switch off the product and remove the power cable.



1. Open the Ink Cartridge Door.



2. Remove the Ink Cartridges from the Printer.



3. Remove one T-15 screw (**Type J**) that secures the Left Cover.



4. Open the Window and remove two T-15 (**Type J**) screws that secure the Left Cover.

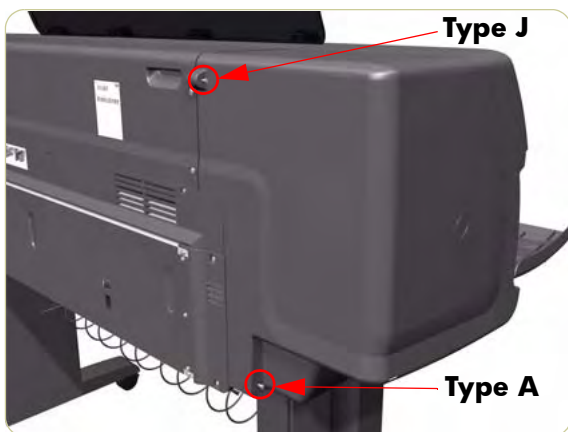

5. Remove one T-15 screw (**Type J**) and one T-20 screw (**Type A**) that secure the Left Cover.

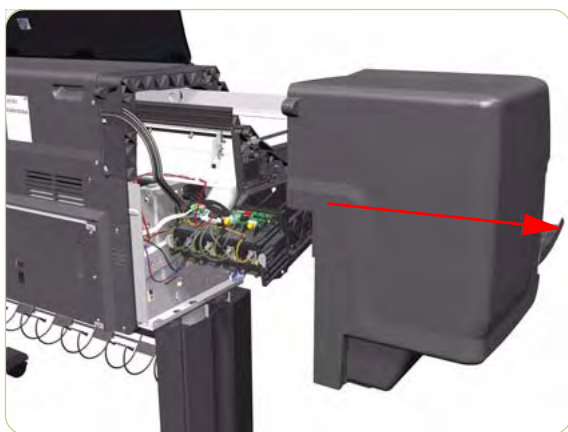

6. Remove the Left Cover from the Printer.

## Top Cover

### Removal

**Switch off the product and remove the power cable.**

1. Remove the Right Cover ⇒ Page 8-6.
2. Remove the Left Cover ⇒ Page 8-9.
3. Release the three clips securing the Ink Supply Tubes and the Trailing Cable to the Top Cover.

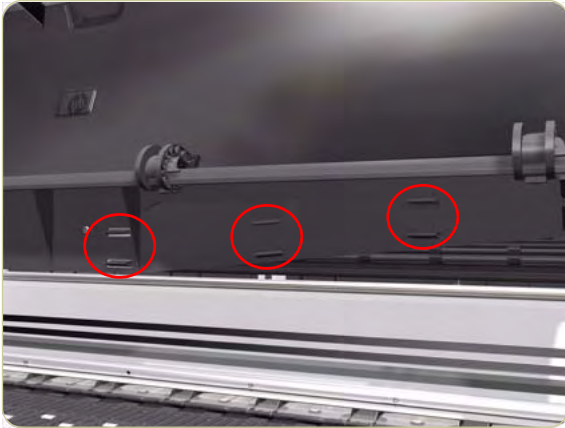

4. Release the Ink Supply Tubes and Trailing Cable from the clip underneath the Top Cover.

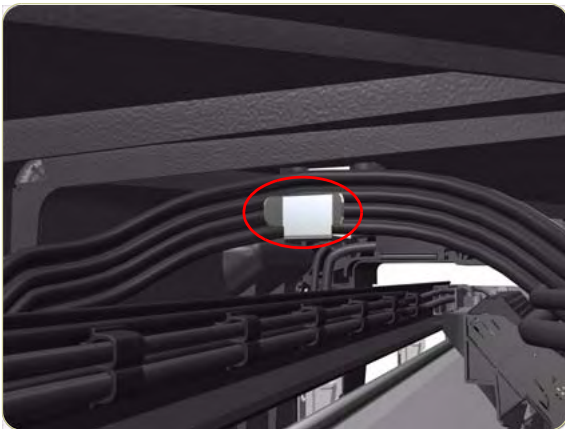

5. Remove the Ink Supply Tubes and Trailing Cable from within the Top Cover and lay them on the Print Platen.

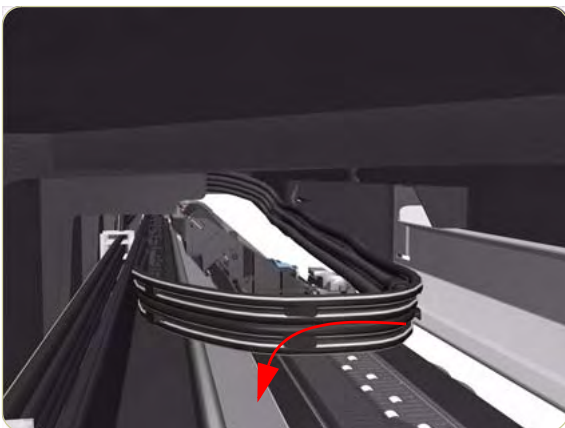

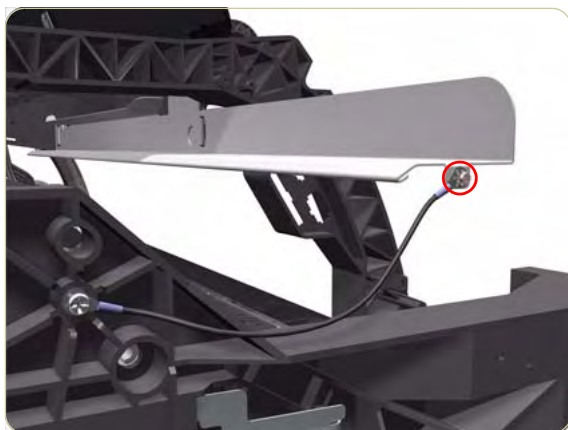

6. Remove one T-10 (**Type I**) screw that secures the ESD Strip to the Top Cover (on the left hand side of the Printer).

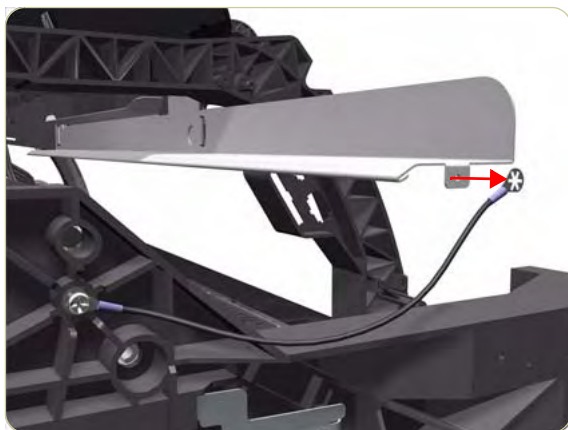

7. Disconnect the ESD Strip from the Top Cover.



8. Remove three T-15 screws (**Type G**) that secure the Rear Door.

**Each screw includes a washer (part number 3050-1267).**



9. Open the Rear Door.



10. Remove four T-15 screws (**Type H**) that secure the Top Cover from the rear of the Printer.



11. Using a flat-head screwdriver, release the Top Cover from the right hand side of the Printer.

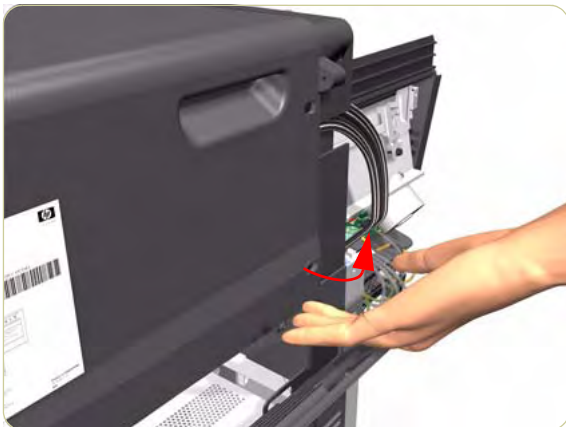

12. Release the Top Cover from the rear of the Printer.

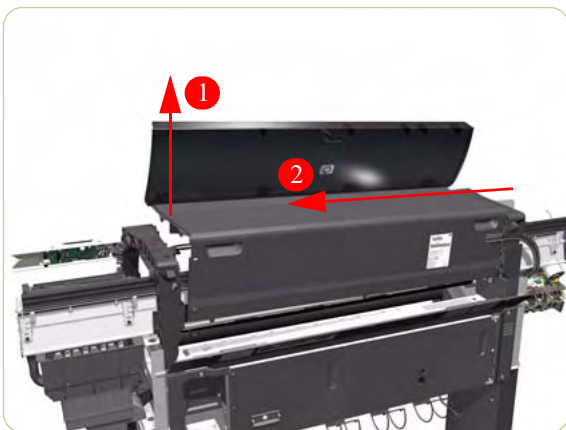

13. Raise the right hand side of the Top Cover and pull out to the right.

**If a NEW Top Cover is to be installed, take note of the following instructions before assembling the Top Cover on to the Printer:**

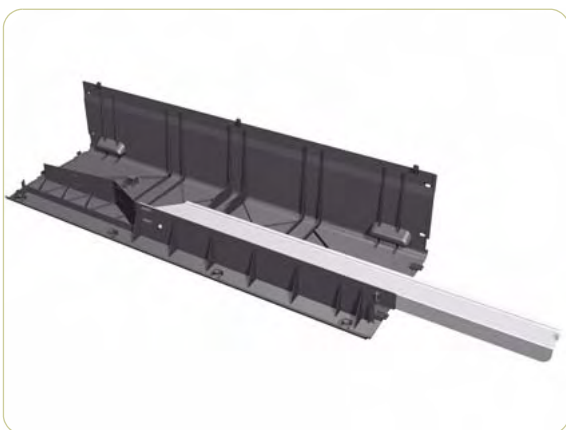

1. Position the Metallic Support on to the Top Cover.



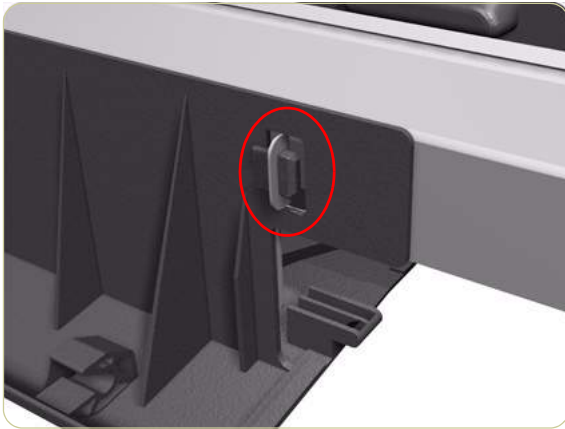

2. Lock the Metallic Support on to the Top Cover.



3. Install the T-20 screw that secures the Metallic Support to the Top Cover.



4. Remove the Window (⇒ Page 8-4) from the old Top Cover and install it on the new Top Cover.

**When installing the Ink Supply Tubes and Trailing Cable on to the Top Cover, take note of the of the two red marks on the Ink Supply Tubes. These two red marks should be aligned with the first slot in the Top Cover as this will help with the rest of the installation.**

## Rear Door

### Removal

Switch off the product and remove the power cable.



1. Remove three T-15 screws (**Type G**) from the Rear Door.

Each screw includes a washer (part number 3050-1267).



2. Open the Rear Door slightly (as shown).

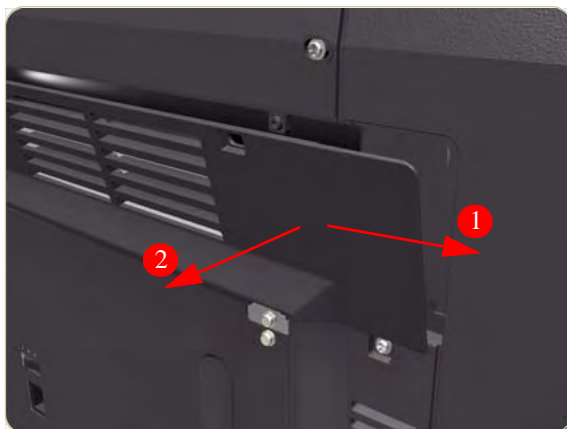

3. To release the right hand hinge of the Rear Door, move the Rear Door to the right and then towards you.

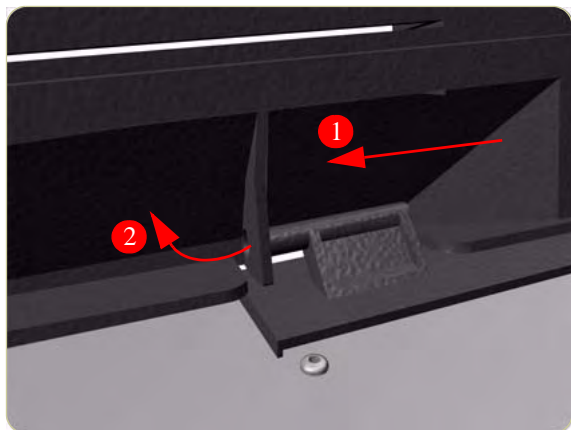

4. To release the left hand hinge of the Rear Door, move the Rear Door to the right and then bend the hinge slightly (as shown).



5. Remove the Rear Door from the Printer.

## Right Connector Cover

### Removal

**Switch off the product and remove the power cable.**

1. Remove the Rear Door ⇒ Page 8-16.
2. Remove two T-20 screws (**Type B**) from the Right Connector Cover.

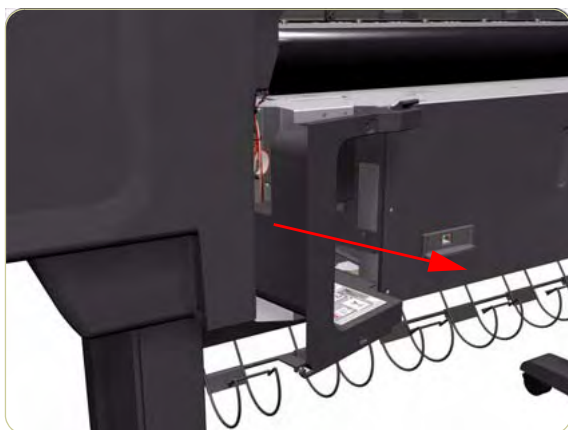
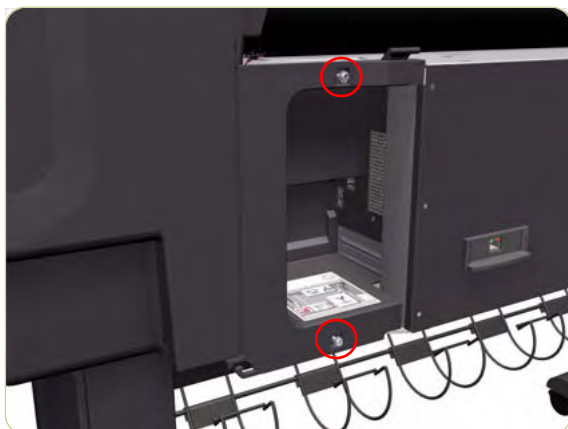

3. Remove the Right Connector Cover from the Printer.

## Left Connector Cover

### Removal

Switch off the product and remove the power cable.

1. Remove the Rear Door ⇒ Page 8-16.
2. Remove two T-20 screws (**Type B**) from the Left Connector Cover.

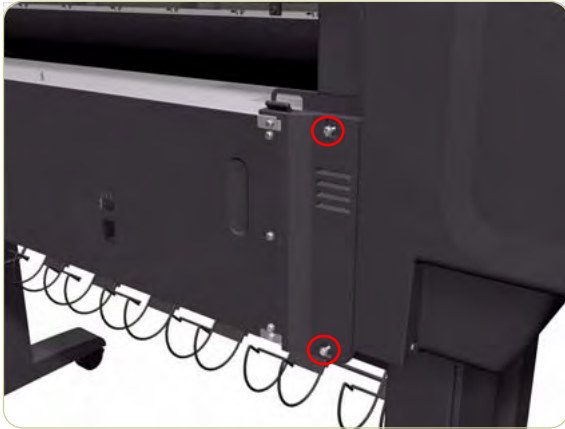

3. Remove the Left Connector Cover from the Printer.

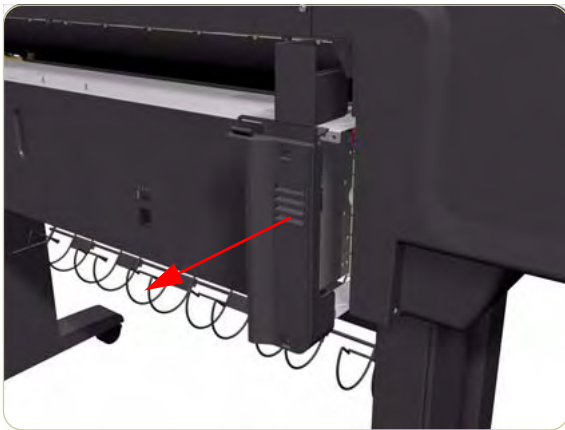

## Front Panel

### Removal

**Switch off the product and remove the power cable.**

1. Remove the Right Cover ⇒ Page 8-6.
2. Remove the Rear Door ⇒ Page 8-16.
3. Remove the Right Connector Cover ⇒ Page 8-18.
4. Disconnect the Front Panel Cable from the Interconnect PCA.



5. Disconnect the Ferrite clip (located on the rear of the Electronics Module) from the front of the Printer.

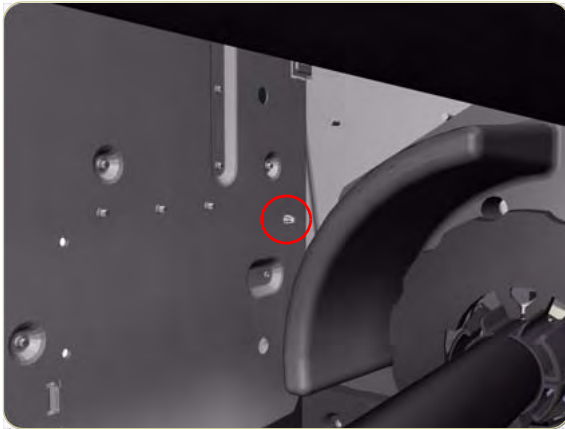

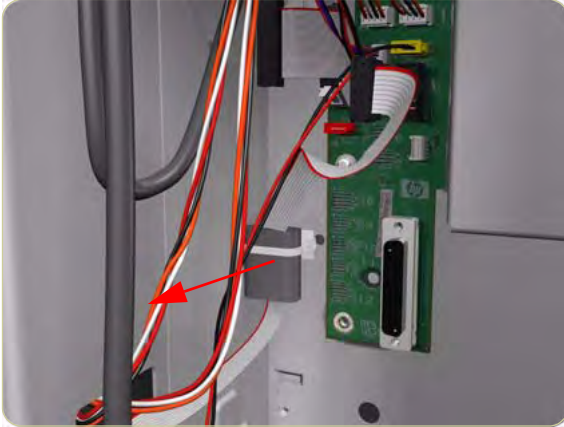

6. Move the Front Panel Cable (including the ferrite) out of the Electronics Module.

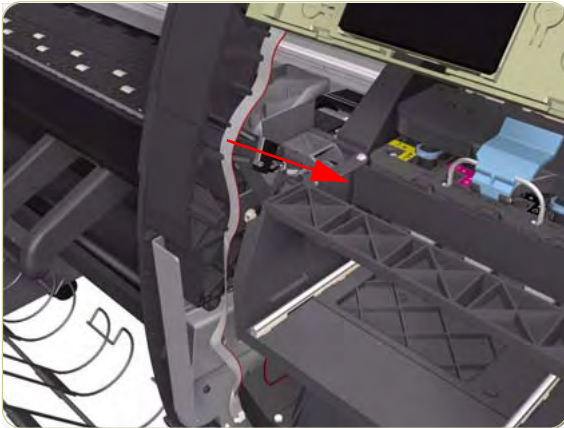

7. Release the Front Panel Cable from the Right Arc.

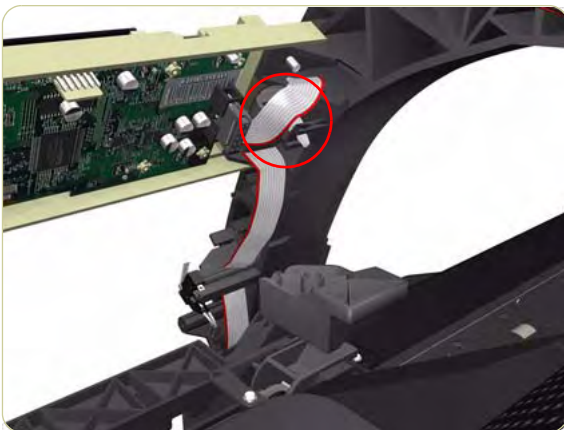

8. Disconnect the Ferrite clip from the Right Arc.

I

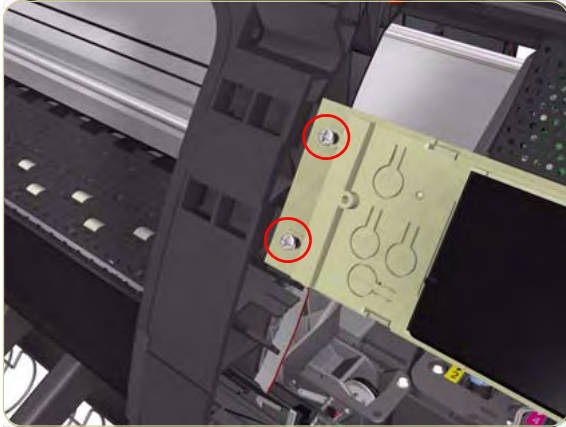

9. Remove two T-15 screws (**Type G**) that secure the Front Panel to the Printer.

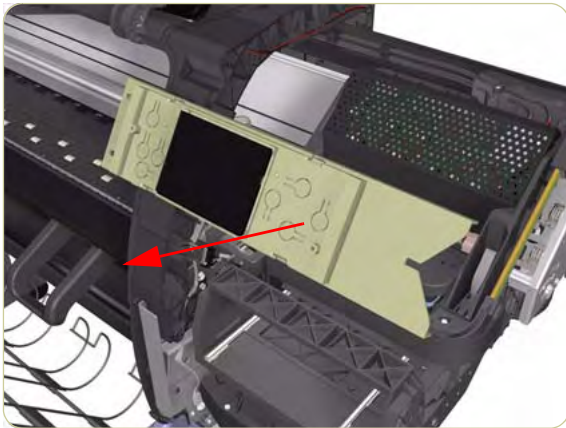

10. Remove the Front Panel from the Printer.



## Service Station

### Removal

**Switch off the product and remove the power cable.**

1. Remove the Right Cover ⇒ Page 8-6.
2. Remove the Rear Door ⇒ Page 8-16.
3. Remove the Right Connector Cover ⇒ Page 8-18.
4. Disconnect the cable from the Printhead Cleaner Door Switch.

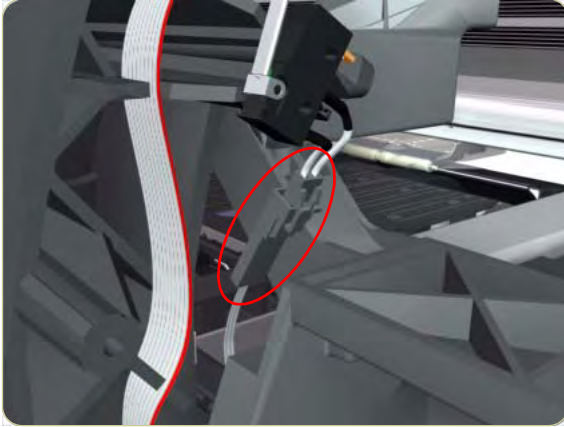

5. Disconnect the Service Station and Aerosol Fan Cables from the Interconnect PCA.

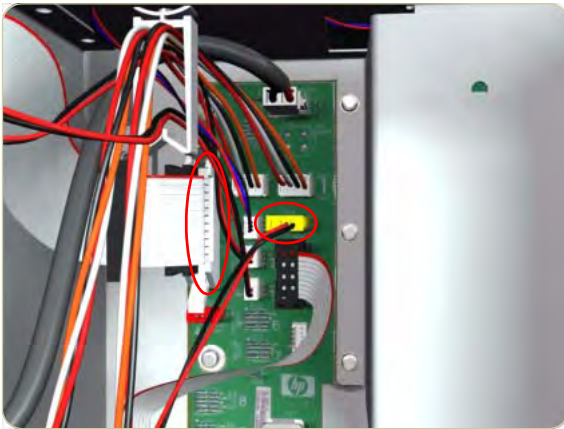

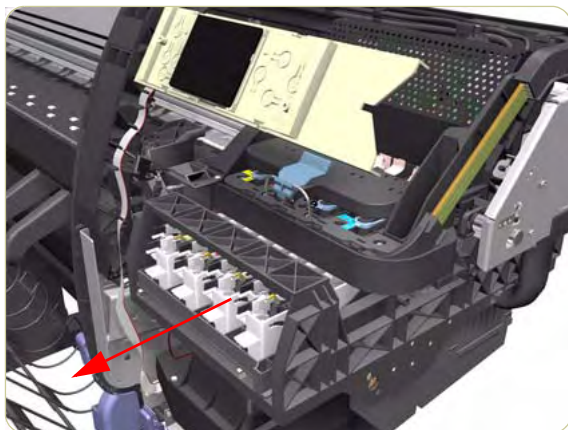

6. Uncap the Carriage Assembly by manually pulling out the Printhead Cleaner tray.

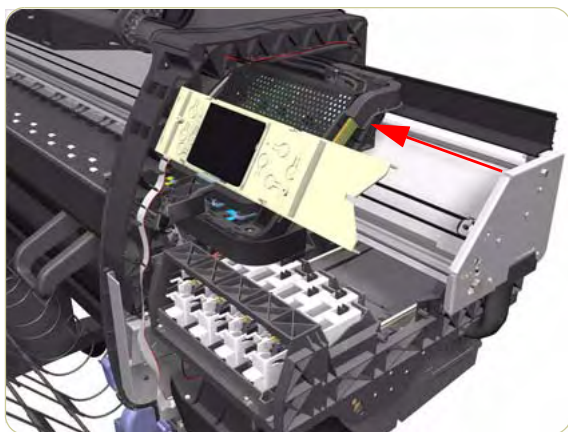

7. Move the Carriage Assembly out of the Service Station.

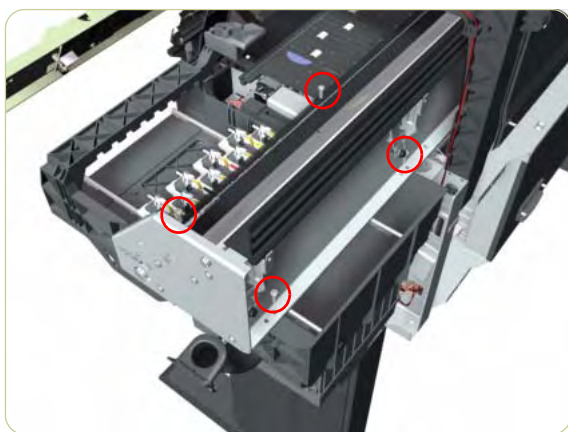

8. Remove four T-15 screws (**Type J**) that secure the Service Station to the Chassis.

**When removing the screws, please be very careful NOT to damage the Encoder Strip.**

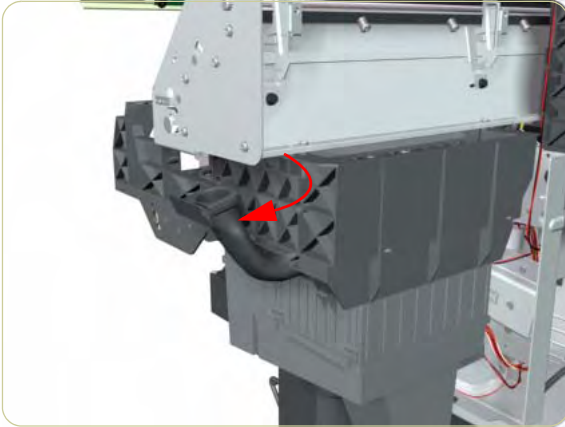

9. Disconnect the Aerosol Fan Tube from the Chassis.

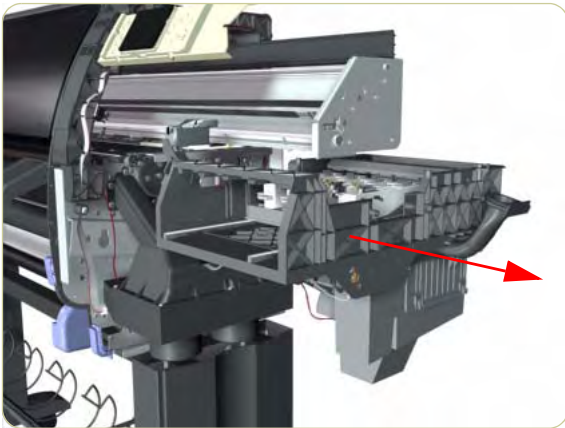

10. Remove the Service Station from the Printer.

**After installing the NEW Service Station, make sure you perform the following Service Utility:**

- Reset Counter PHC spittoon ⇒ Chapter 4.

**After installing the NEW Service Station, make sure you perform the following Service Calibration:**

- Service Station Calibration ⇒ Chapter 5.

## Removal of the Service Station Scraper

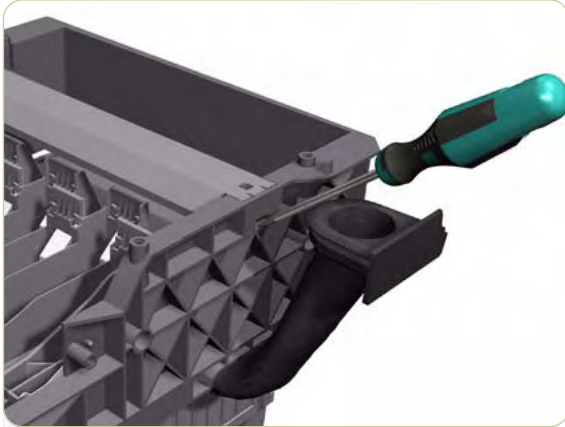

1. Release the clip securing the Scraper to the Service Station.

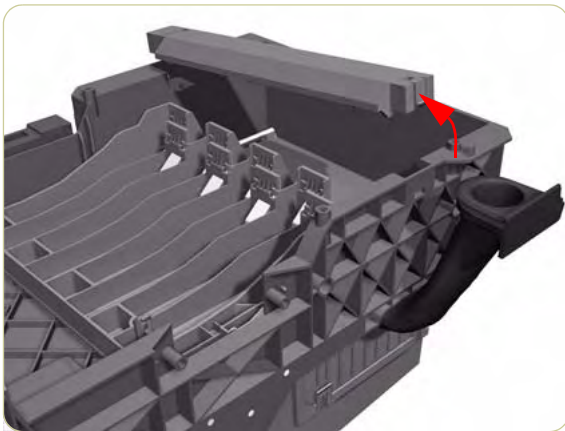

2. Remove the Scraper from the Service Station.

## Vacuum Fan

### Removal

**Switch off the product and remove the power cable.**

1. Remove the Right Cover ⇒ Page 8-6.
2. Remove the Rear Door ⇒ Page 8-16.
3. Remove the Right Connector Cover ⇒ Page 8-18.
4. Remove the Service Station ⇒ Page 8-23.
5. Release the Pinchwheel Lever Sensor Cable from the Vacuum Fan.

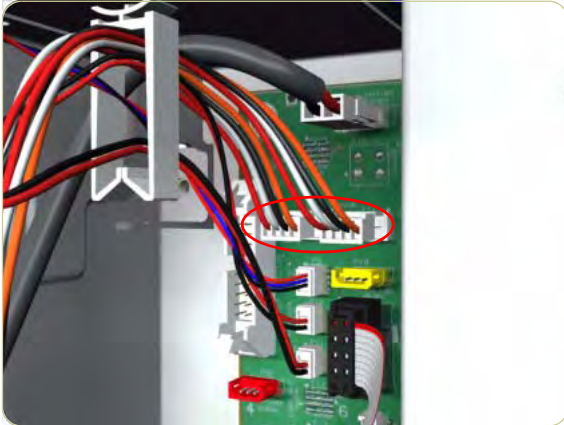
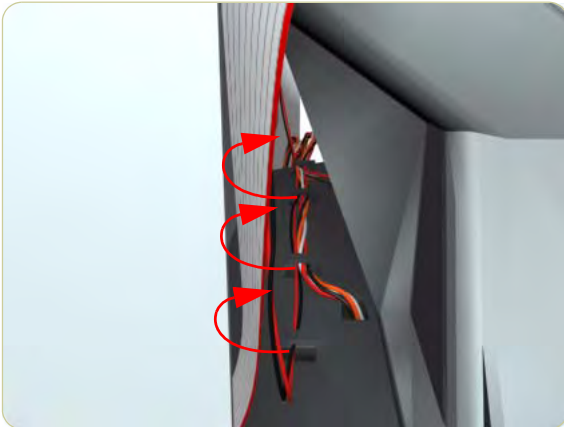

6. Disconnect both Vacuum Fan cables from the Interconnect PCA.

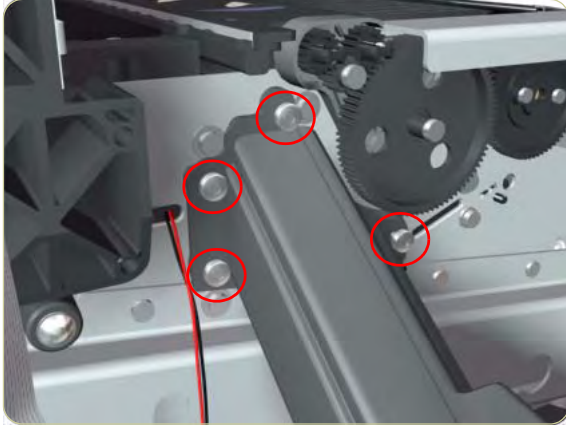

7. Remove four T-20 screws (**Type B**) that secure the Vacuum Fan to the Printer.

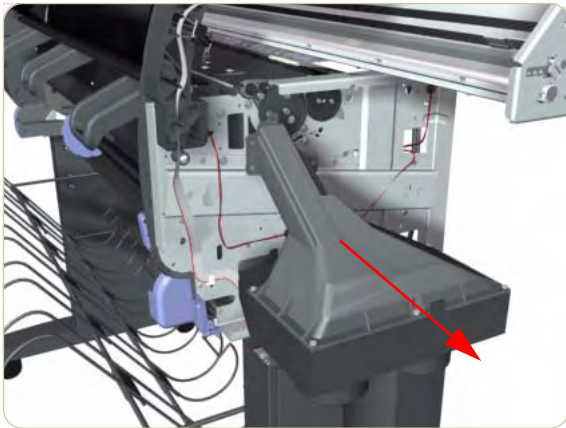

8. Remove the Vacuum Fan from the Printer.

**After installing the NEW Vacuum Fan, make sure you perform the following Service Calibration:**

- Paper Advance Calibration ⇒ Chapter 5.

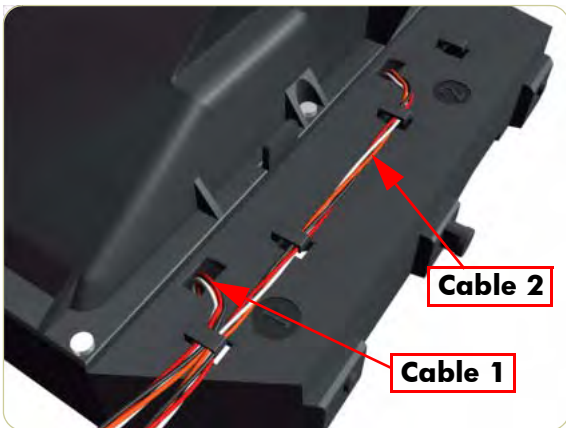

**When connecting the Vacuum Fan cables to the Interconnect PCA, make sure you connect the cable with the label marked Vacuum Fan 1 to connector 1 and the cable with the label marked Vacuum Fan 2 to connector 2. You can verify if both cables are labelled correctly by the actual markings on the Vacuum Fan.**

## Aerosol Fan

### Removal

Switch off the product and remove the power cable.

1. Remove the Right Cover ⇒ Page 8-6.
2. Remove the Rear Door ⇒ Page 8-16.
3. Remove the Right Connector Cover ⇒ Page 8-18.
4. Remove the Service Station ⇒ Page 8-23.
5. Unclip the bottom cover from the Aerosol Fan.

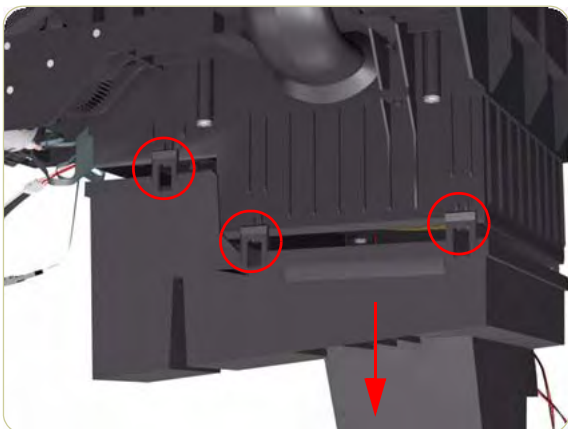

6. Remove four T-15 screws (**Type G**) that secure the Aerosol Fan to the Service Station.

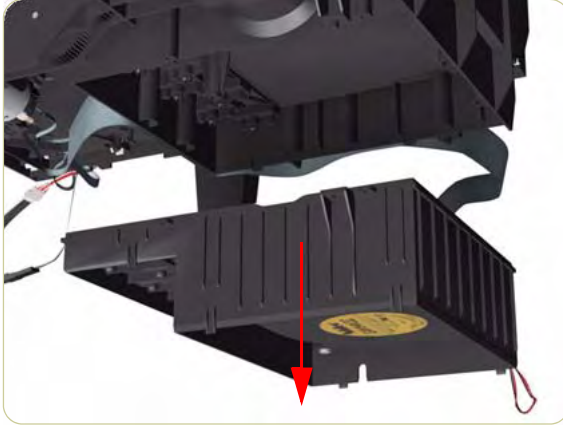

**7.** Remove the Aerosol Fan from the Service Station.

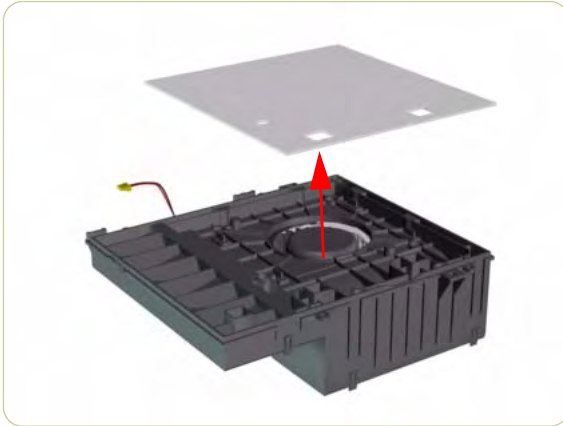

**8.** If necessary, remove the Aerosol Fan Filter from the Aerosol Fan.



## Drop Detector

### Removal

Switch off the product and remove the power cable.

1. Remove the Right Cover ⇒ Page 8-6.
2. Disconnect the Drop Detector Cable from the Service Station Cable.

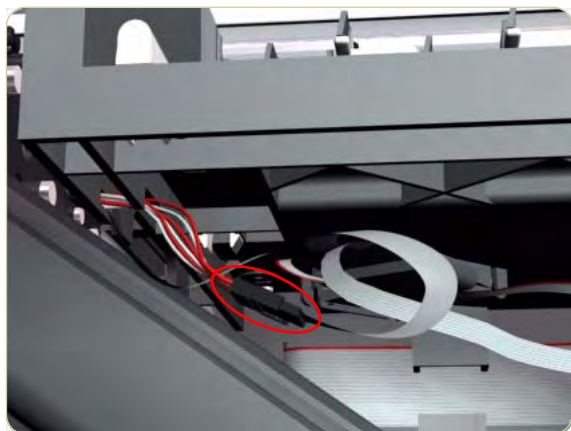

3. Release the Drop Detector Cable from the Service Station.

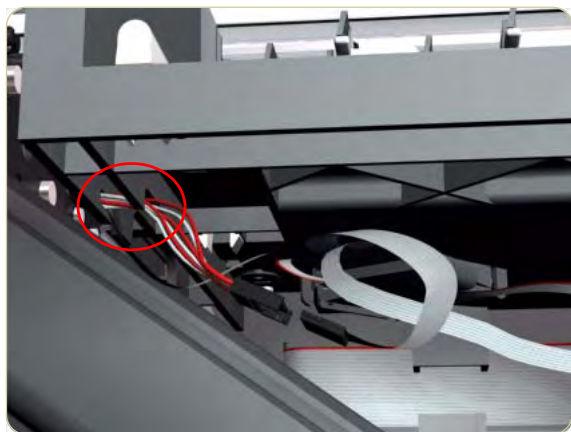

4. Remove one T-8 screw (**Type K**) that secures the Drop Detector to the Service Station.

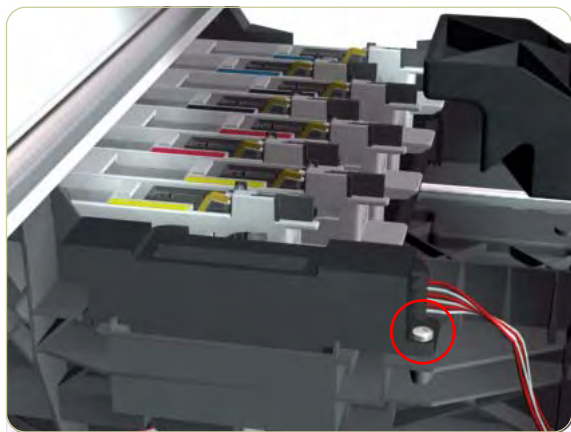

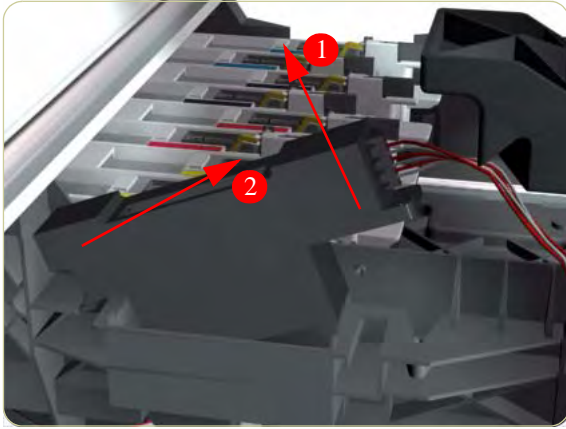

5. Remove the Drop Detector from the Printer.

**After installing the NEW Drop Detector, make sure you perform the following Service Calibration:**

- Drop Detector Calibration ⇒ Chapter 5.

## Ink Supply Tubes and Trailing Cable

### Removal

Switch off the product and remove the power cable.

**You MUST NEVER replace both the Hard Disk Drive and the Ink Supply Tubes and Trailing Cable at the same time. If both parts need to be replaced, you MUST first replace one part and then power ON the Printer until it completely initializes. Then you can power OFF the Printer and replace the other part.**

1. Remove the Right Cover ⇒ Page 8-6.
2. Remove the Left Cover ⇒ Page 8-9.
3. Remove the Top Cover ⇒ Page 8-11.
4. Remove the Rear Door ⇒ Page 8-16.
5. Remove the Right Connector Cover ⇒ Page 8-18.
6. Disconnect the Trailing Cable from the Interconnect PCA and the Gamut PCA.

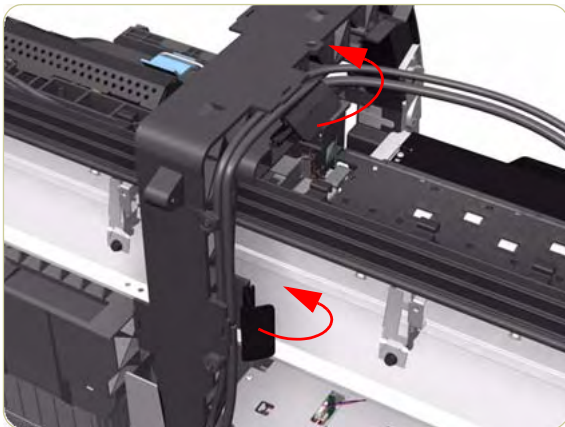
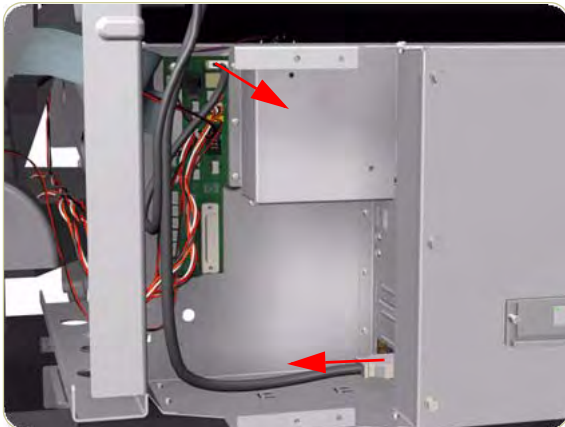

7. Release the two plastic clips securing the Trailing Cable.

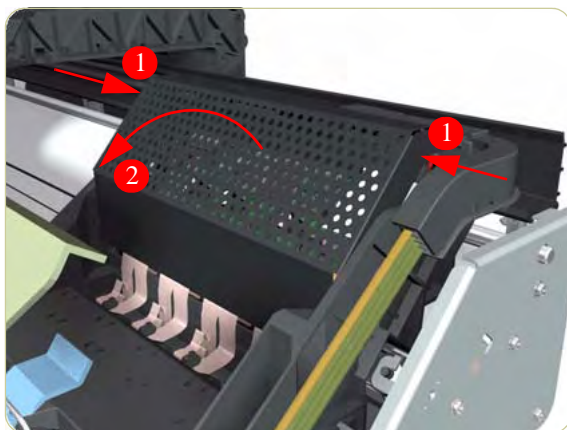

- 8.** Press the two side of the Carriage PCA Cover and unclip from the Carriage Assembly.

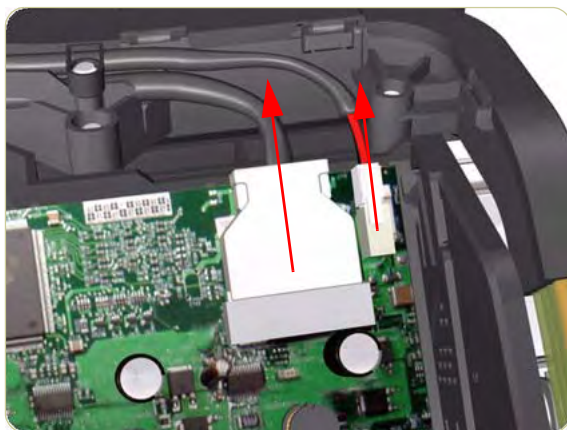

- 9.** Disconnect the Trailing Cable from the Carriage PCA.

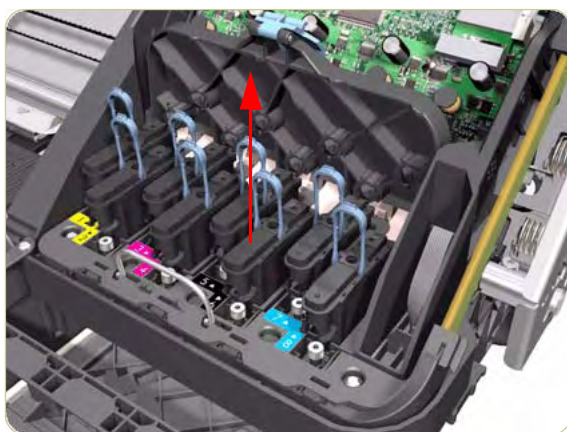

- 10.** Open the Carriage Cover and remove ALL the Printheads from the Carriage Assembly.

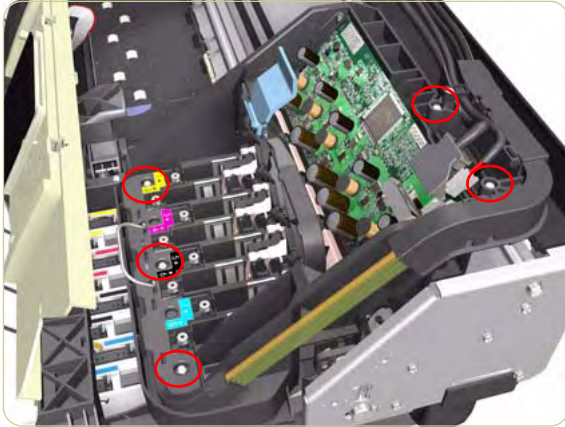

11. Remove five T-15 screws (**Type G**) that secure the Ink Supply Tubes to the Carriage Assembly.

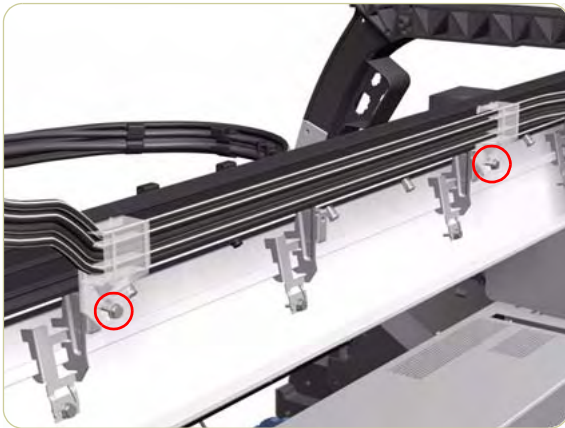

12. Remove one T-20 screw (**Type B**) from each plastic holder at the rear of the Printer.

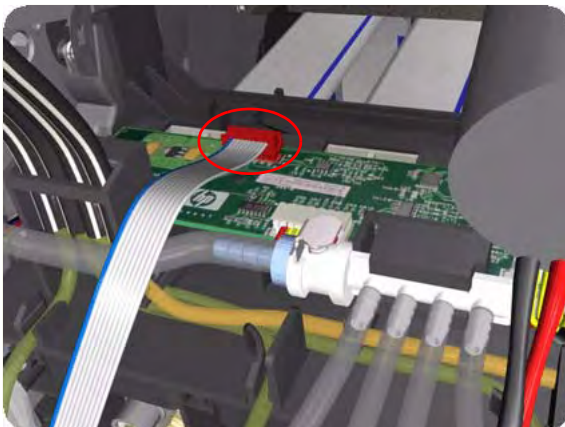

13. Disconnect the Electrical Cable from the rear of the Ink Cartridge Tube Connector.

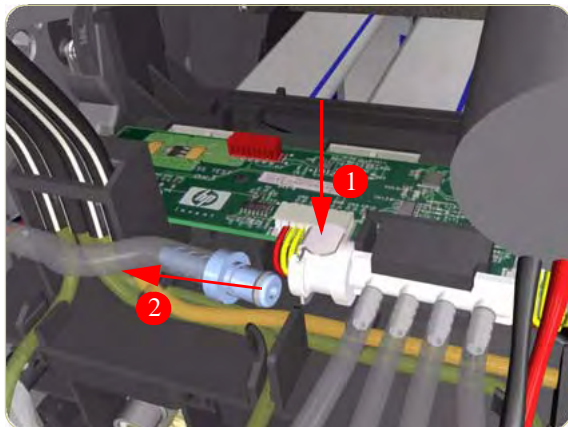

**14.** Disconnect the Air Tube from the Ink Supply Tubes.

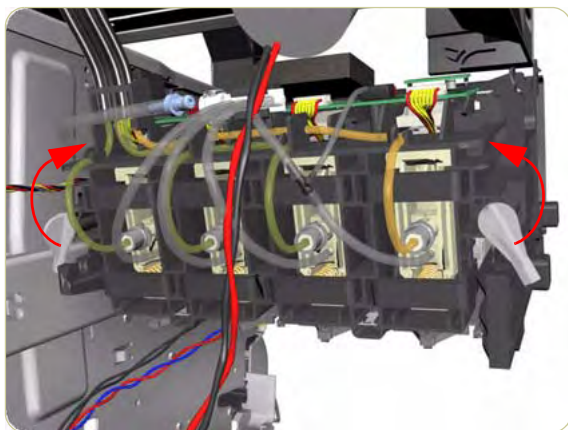

**15.** Twist the 2 latches at the rear of the Ink Cartridge Tube Connector and release the complete assembly.

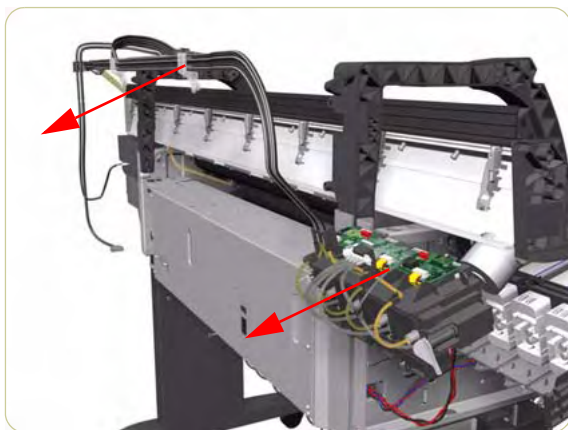

**16.** Remove the Ink Supply Tubes and Trailing Cable from the Printer.

## Installation of the Ink Supply Tubes and Trailing Cable

**After installing the NEW Ink Supply Tubes and Trailing Cable, make sure you perform the following Service Utility:**

- Reset life counter scan cycles tubes/cable ⇒ Chapter 4.



**When installing the Ink Supply Tubes and Trailing Cable on to the Top Cover, take note of the of the two red marks on the Ink Supply Tubes. These two red marks should be aligned with the first slot in the Top Cover as this will help with the rest of the installation.**

## ISS to Cartridge Cables

### Removal

**Switch off the product and remove the power cable.**

1. Remove the Left Cover ⇒ Page 8-4.
2. Disconnect the ISS to Cartridge Cable from the ISS PCA.

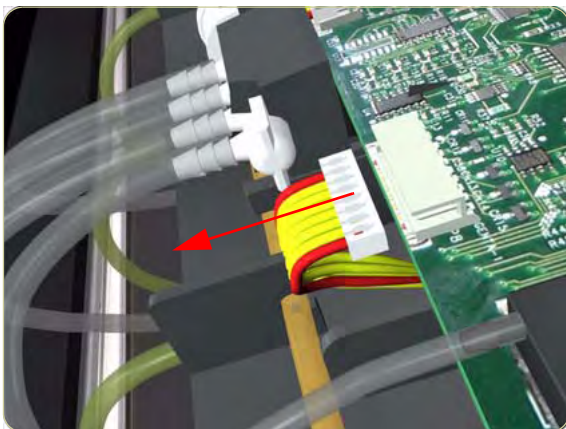

3. Release the clips securing the ISS to Cartridge Cable.

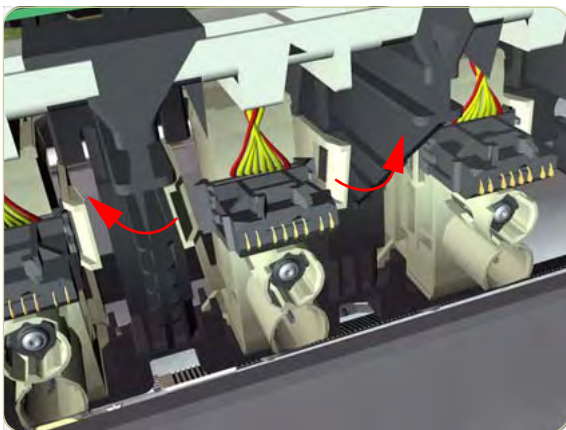

4. Remove the ISS to Cartridge Cable from the Printer.

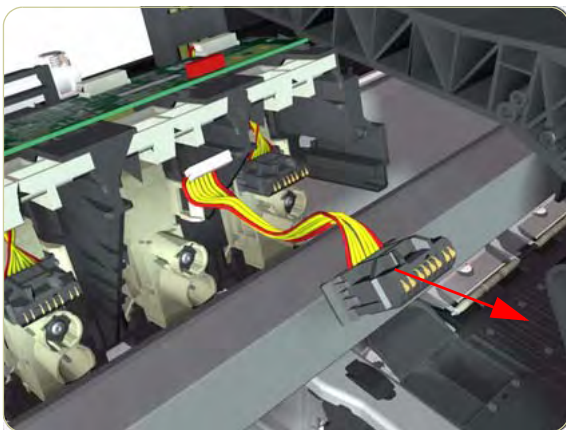



## Cutter Assembly

### Removal

1. Select "Replace Cutter" from Service Menu (refer to Chapter 4) and follow the instructions on the Front Panel.
2. Open the Window.



3. Remove one T-15 screw (**Type G**) that secures the Cutter Assembly to the Carriage Assembly.

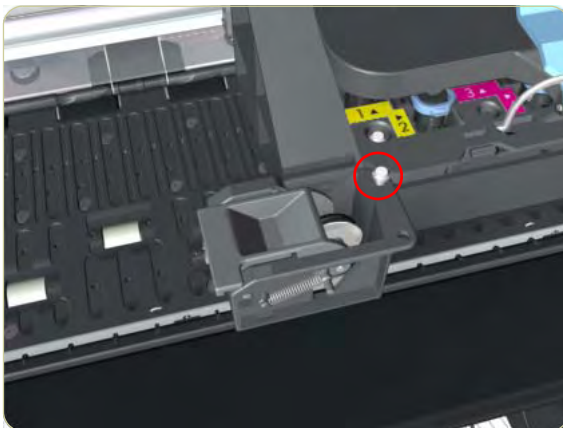

4. Slide the Cutter Assembly to the left and remove from the Printer.

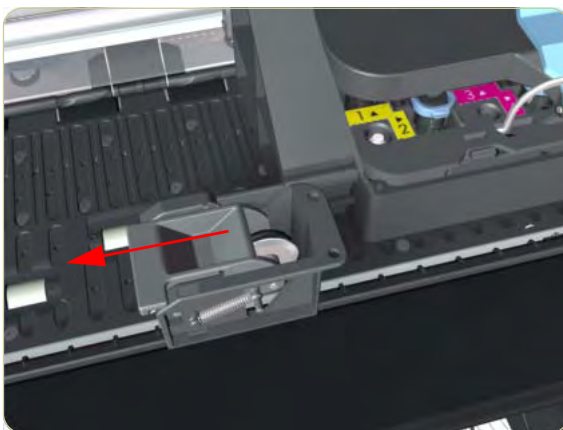

## Ink Supply Station (ISS)

### Removal

Switch off the product and remove the power cable.

1. Remove the Left Cover ⇒ Page 8-4.
2. Remove the Left Connector Cover ⇒ Page 8-19.
3. Disconnect the Electrical Cable from the rear of the Ink Cartridge Tube Connector.

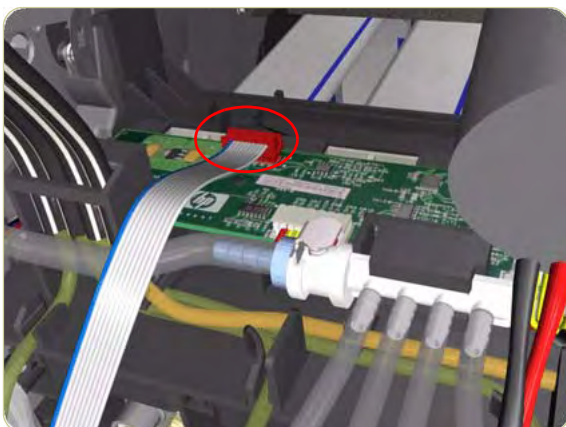

4. Disconnect the Air Tube from the Ink Supply Tubes.

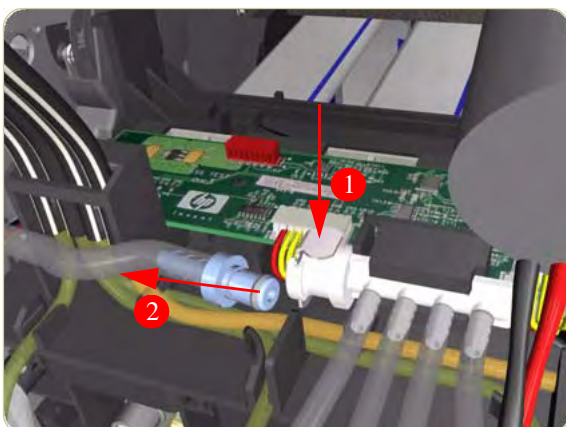

5. Twist the 2 latches at the rear of the Ink Cartridge Tube Connector and release the complete assembly.

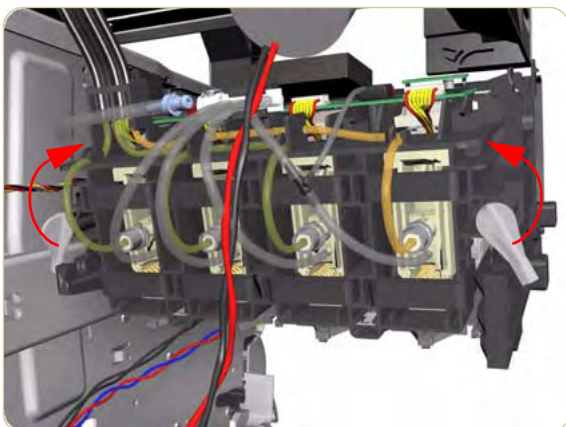

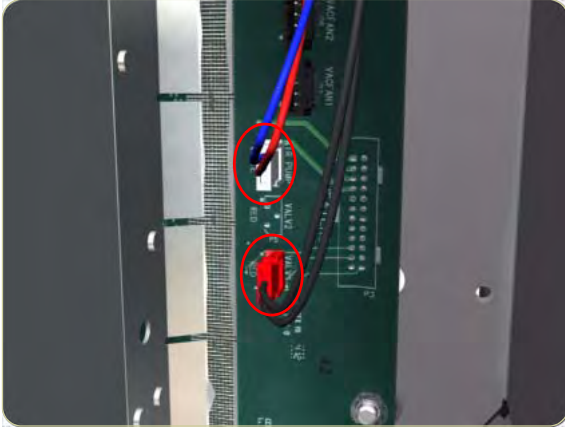

6. Disconnect the two Ink Supply Station cables from the PrintMech PCA.

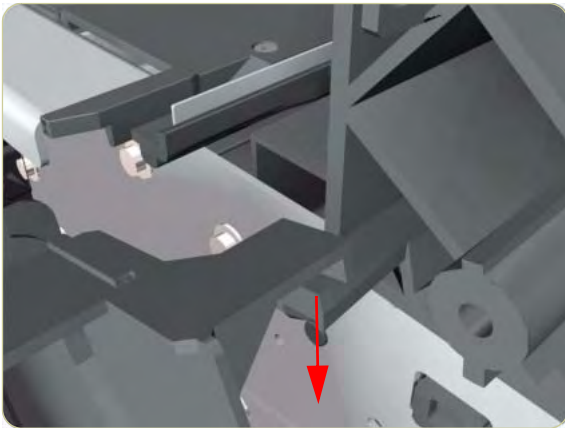

7. Release the Ink Supply Station from the Chassis.

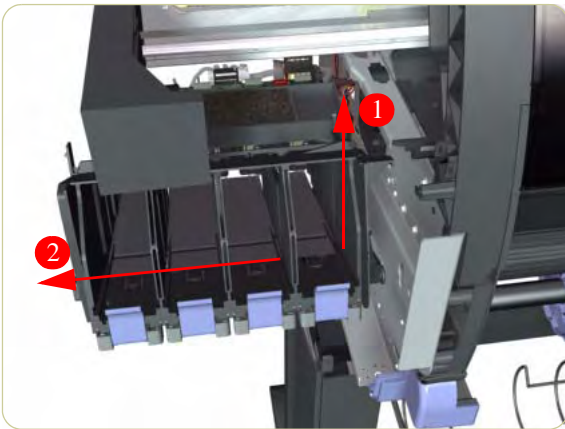

8. Remove the Ink Supply Station from the Printer.

## APS Assembly

### Removal

1. Remove the Left Cover ⇒ Page 8-4.
2. Remove the Left Connector Cover ⇒ Page 8-19.
3. Remove the ISS ⇒ Page 8-40.
4. Release the Air Tube from the Slot in the Ink Supply Station.

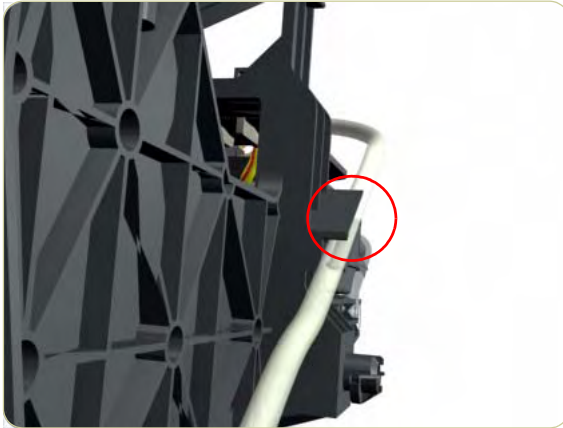

5. Unclip the APS Assembly from the Ink Supply Station.

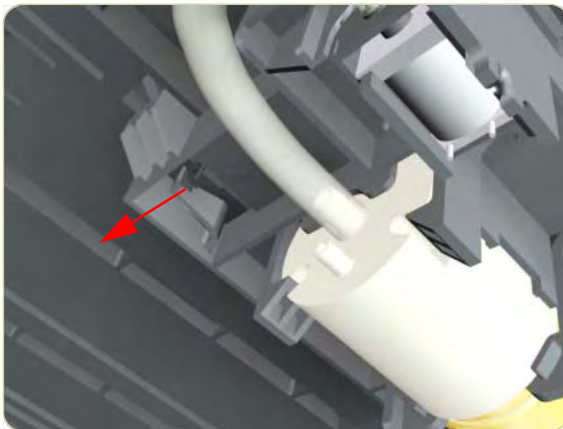

6. Remove the APS Assembly from the Ink Supply Station.

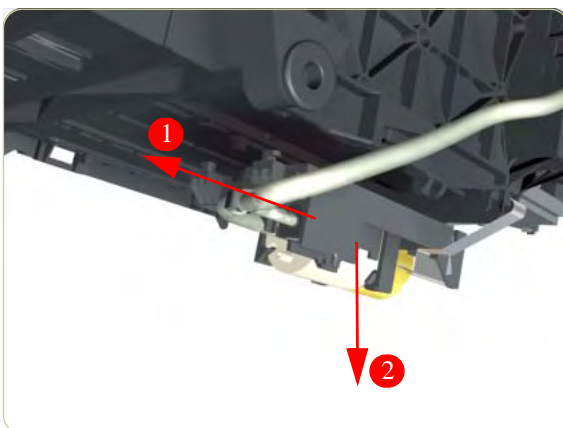

## Most Left Spittoons

### Removal

**Switch off the product and remove the power cable.**

1. Remove the Left Cover ⇒ Page 8-9.
2. Remove one T-15 screw (**Type G**) that secures the Most Left Spittoons to the Ink Supply Station.



**Use a Screwdriver with a small head so that the screw can be removed easily.**

3. Remove the Most Left Spittoons from the Printer.

**After installing the NEW Most Left Spittoons, make sure you perform the following Service Utility:**

- Reset life counter most left spittoon ⇒ Chapter 4.



## Middle Left Spittoons

### Removal

Switch off the product and remove the power cable.

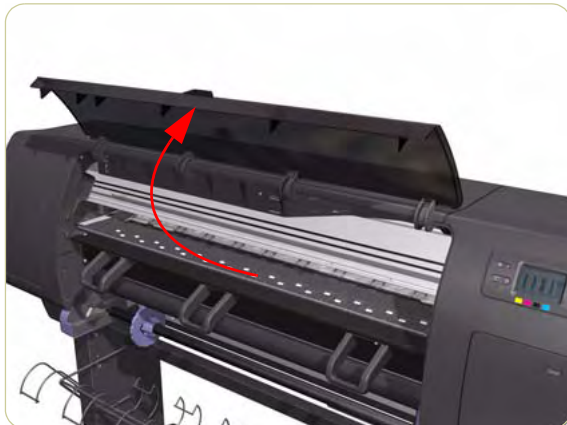

1. Open the Window.



2. Remove one T-10 screw (**Type C**) that secures the Middle Left Spittoons.

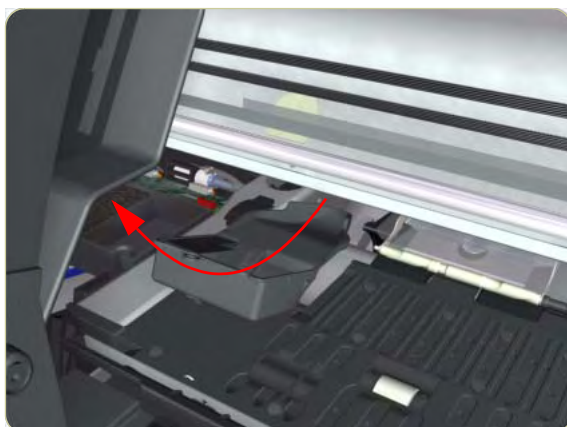

3. Remove the Middle Left Spittoons from the Printer.

**After installing the NEW Middle Left Spittoons, make sure you perform the following Service Utility:**

- Reset life counter mid left spittoon ⇒ Chapter 4.

## Encoder Strip and Encoder Sensor

### Removal

Switch off the product and remove the power cable.

1. Remove the Right Cover ⇒ Page 8-6.
2. Remove the Left Cover ⇒ Page 8-9.
3. Uncap the Carriage Assembly by manually pulling out the Printhead Cleaner tray.

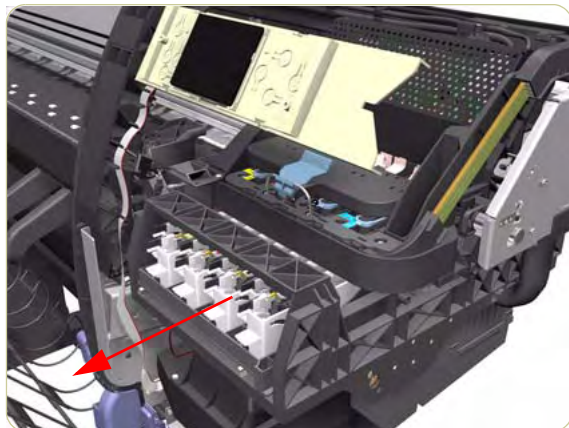

4. Move the Carriage Assembly out of the Service Station.

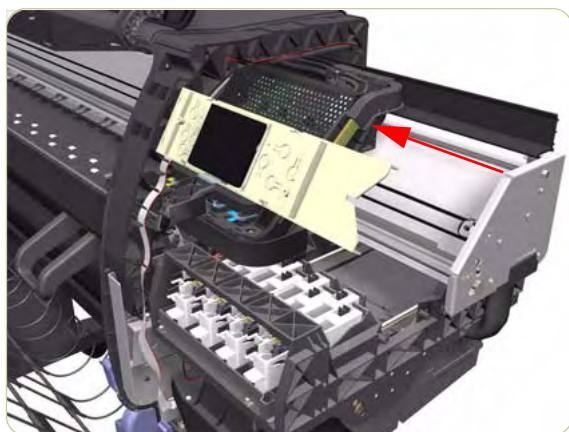

5. Remove one T-10 screw (**Type I**) that secures the Encoder Strip on the right hand side of the Printer.



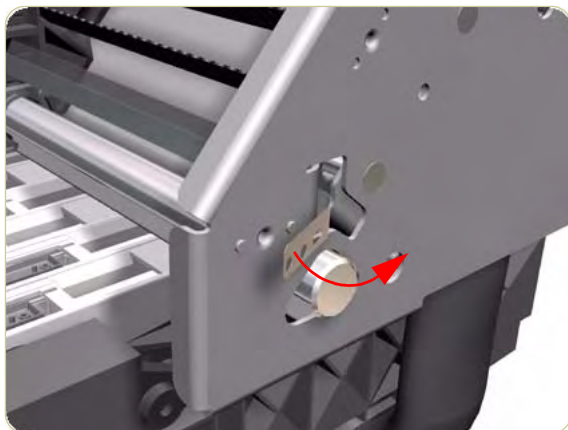

6. Release the Encoder Strip from the locating pins on the right hand side of the Printer.

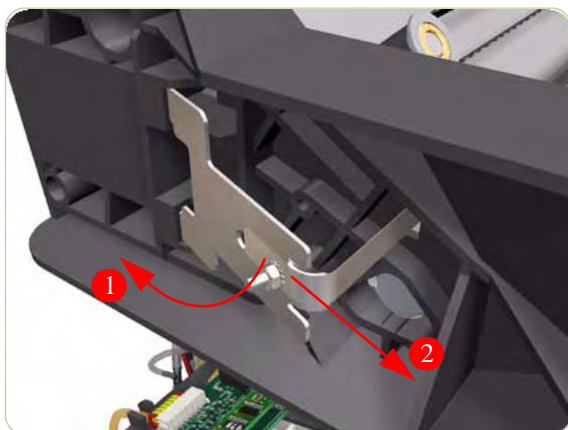

7. Release the Spring Clip from the Bracket on the left hand side of the Printer.

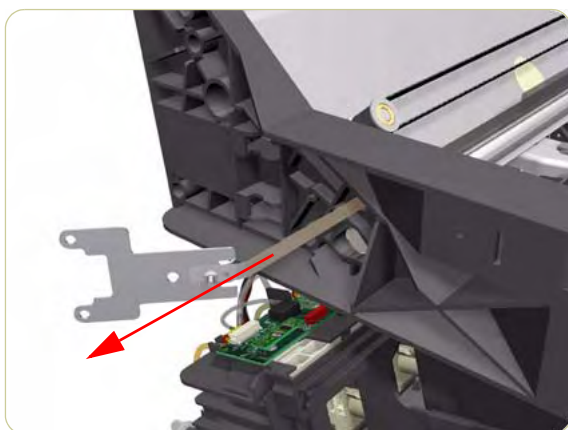

8. Pull the Encoder Strip out of the left hand side of the Printer.

9. Remove the Carriage PCA ⇒ Page 8-48.

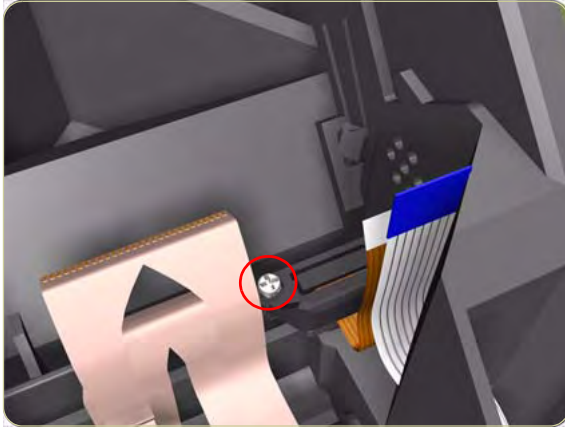

**I**

- 10.** Remove one T-8 (**Type L**) screw that secures the Encoder Sensor to the Carriage Assembly.

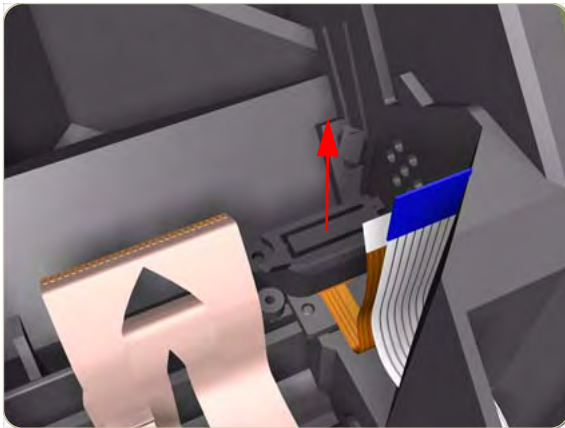

- 11.** Remove the plastic cover from the Encoder Sensor.

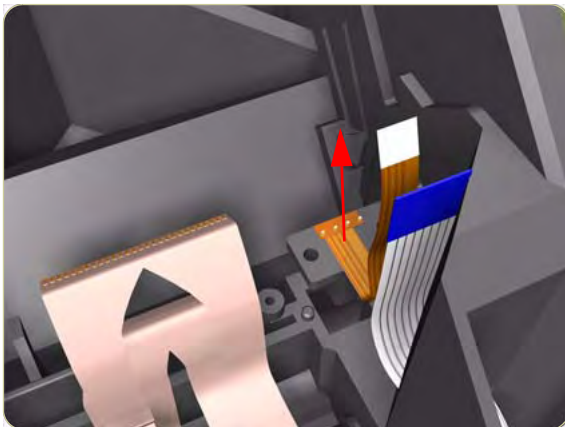

- 12.** Remove the Encoder Sensor from the Printer.

**After installing the NEW Encoder Strip and Encoder Sensor, make sure you perform the following Service Calibration:**

- Scan-Axis Calibration ⇒ Chapter 5.

## Carriage PCA

### Removal

**Switch off the product and remove the power cable.**

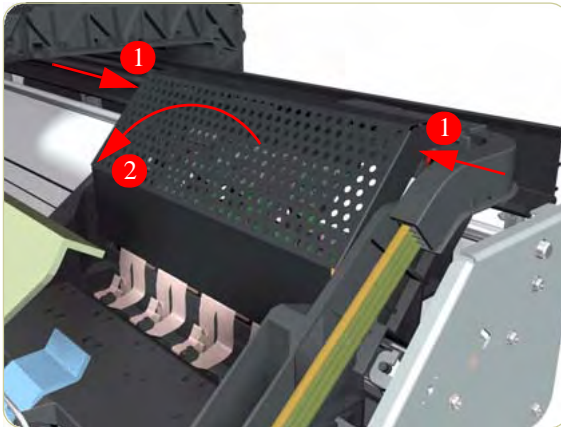

1. Remove the Right Cover ⇒ Page 8-6.
2. Press the two side of the Carriage PCA Cover and unclip from the Carriage Assembly.

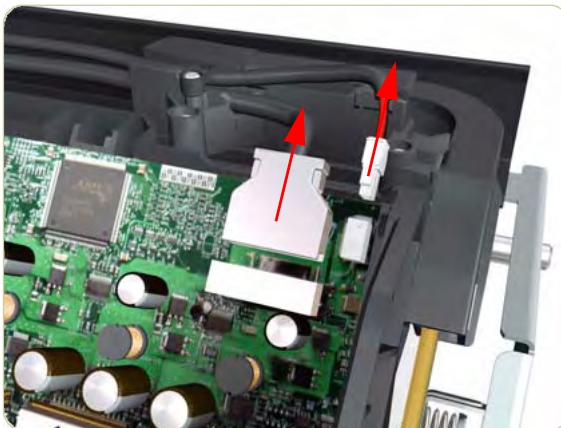

3. Disconnect the Trailing Cable from the Carriage PCA.

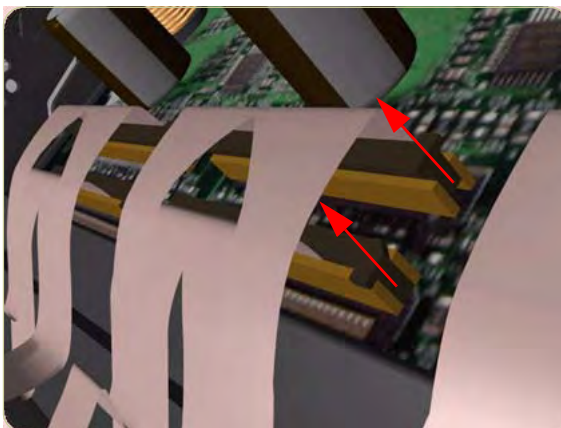

4. Release the ALL the clips, securing the Carriage Flex Cables to the Carriage PCA, by pulling upwards.



5. Disconnect the Flex Cables from the Carriage PCA.

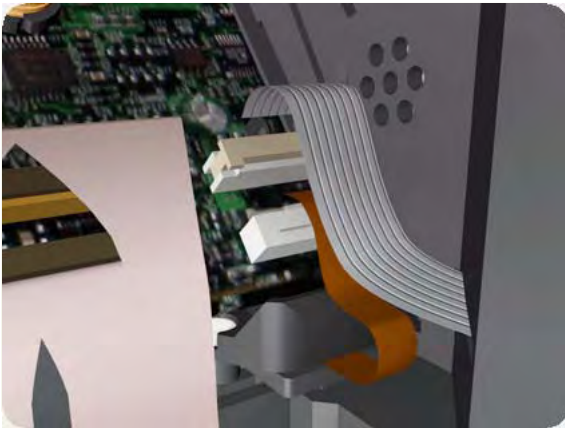

6. Disconnect the Line Sensor Cable and the Encoder Sensor Cable from the Carriage PCA.

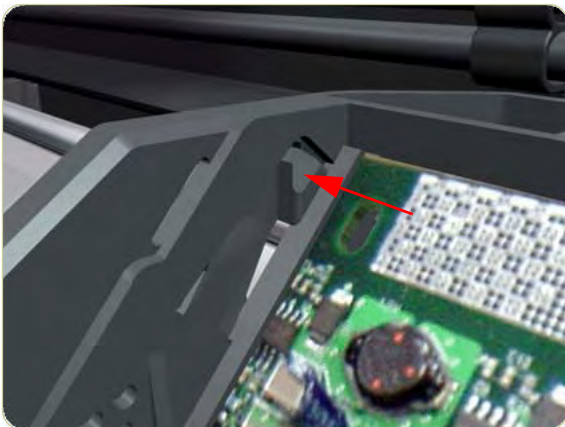

7. Push inwards the four clips that secure the Carriage PCA.

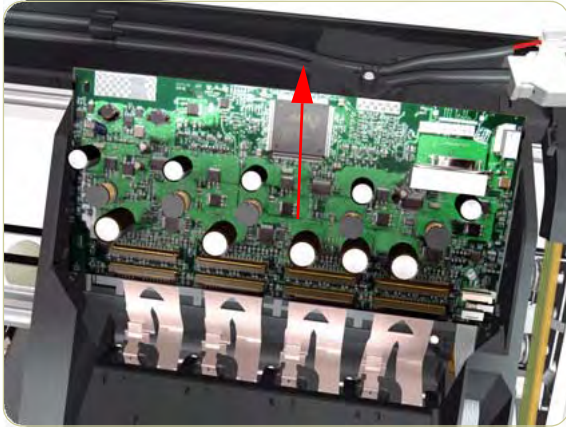

8. Remove the Carriage PCA from the Printer.

**Once you have installed a NEW Carriage PCA, you MUST perform the following steps to ensure that the Printer will function correctly:**

1. Power ON the Printer.
2. Execute the "Carriage Setup" Utility from the Service Utility Menu (Refer to Chapter 4 for more information).
3. Install the Printheads once the Utility has been completed successfully.
4. Reset life counter Carriage PCA ⇒ Chapter 4.

## Carriage Flex Cables

### Removal

**Switch off the product and remove the power cable.**

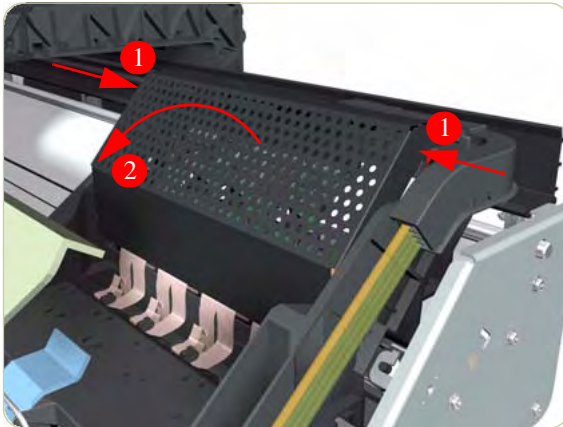

1. Remove the Right Cover ⇒ Page 8-6.
2. Press the two side of the Carriage PCA Cover and unclip from the Carriage Assembly.



3. Release the ALL the clips, securing the Carriage Flex Cables to the Carriage Assembly, by pulling upwards.



4. Disconnect the Flex Cables from the Carriage PCA.

I

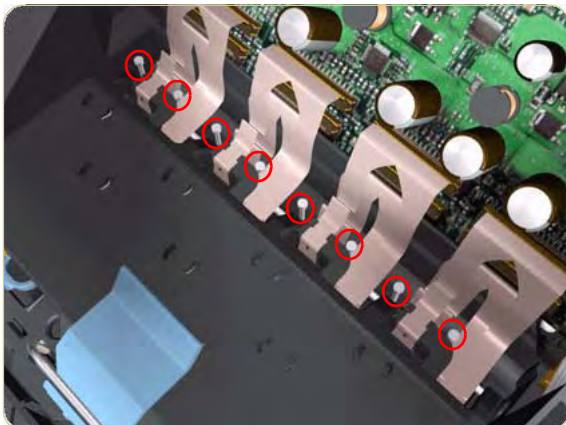

5. Remove eight T-8 screws (**Type L**) that secure the Carriage Flex Cables to the Carriage Assembly.

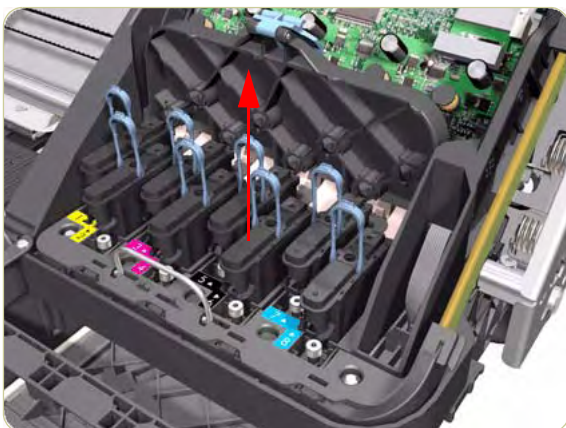

6. Open the Carriage Cover and remove ALL the Printheads from the Carriage Assembly.

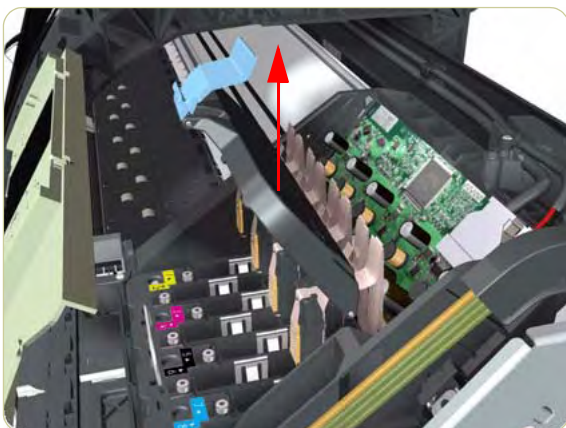

7. Remove the Carriage Flex Cable from the Printer.

## Carriage Assembly

### Removal

**Switch off the product and remove the power cable.**

1. Remove the Right Cover ⇒ Page 8-6.
2. Remove the Left Cover ⇒ Page 8-9.
3. Remove the Encoder Strip ⇒ Page 8-45.
4. Move the Carriage Assembly to the extreme right of the Printer.

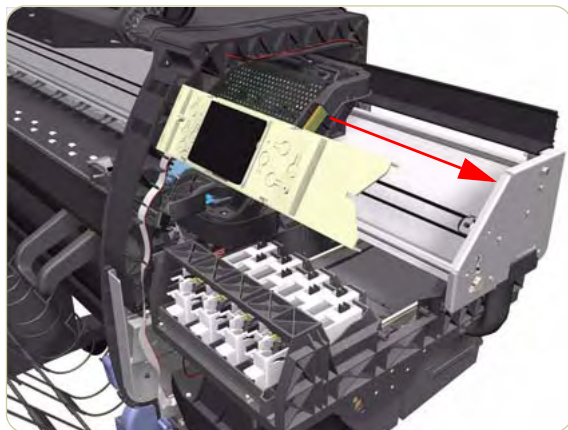

5. Press the two side of the Carriage PCA Cover and unclip from the Carriage Assembly.

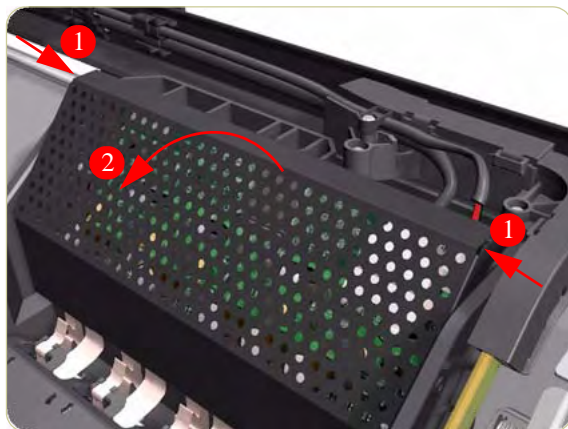

6. Disconnect the Trailing Cable from the Carriage PCA.

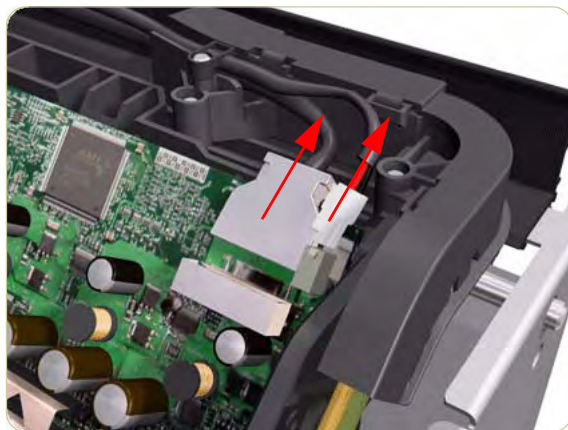

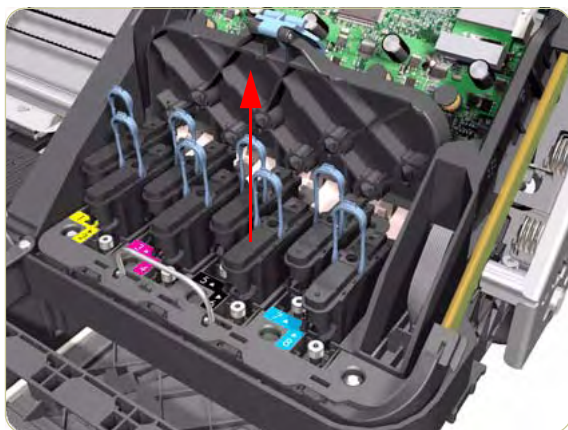

7. Open the Carriage Cover and remove ALL the Printheads from the Carriage Assembly.

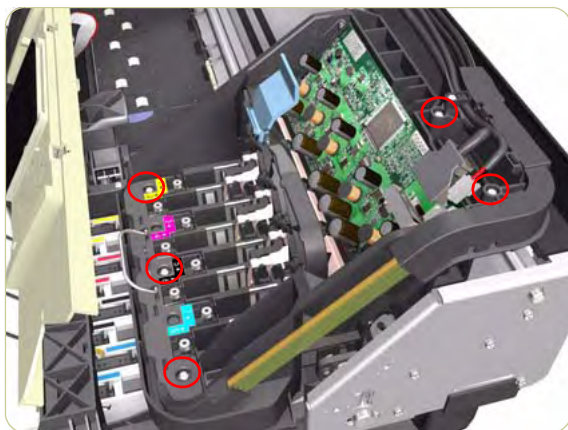

8. Remove five T-15 screws (**Type G**) that secure the Ink Supply Tubes to the Carriage Assembly.

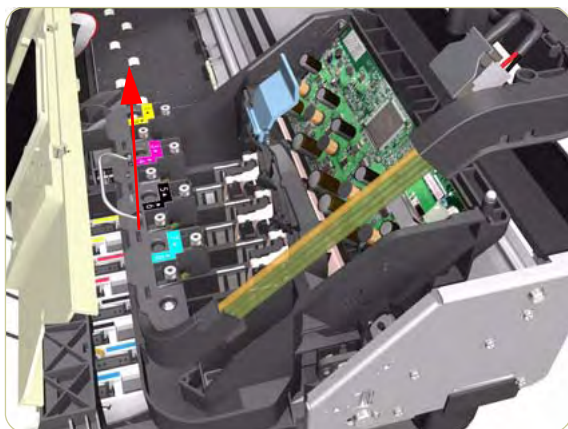

9. Remove the Ink Supply Tubes from the Carriage Assembly and safely place to one side of the Printer.



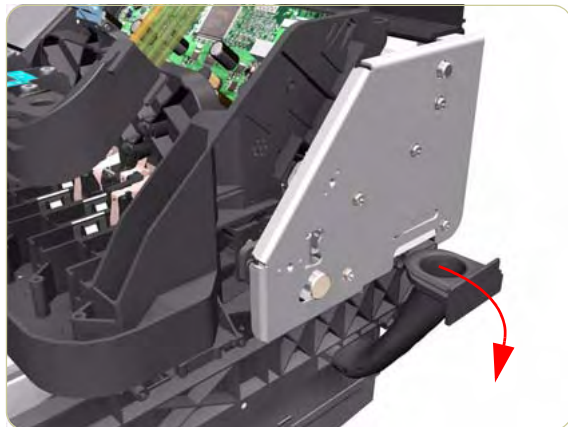

**10.** Disconnect the Aerosol Fan Tube from the Chassis.

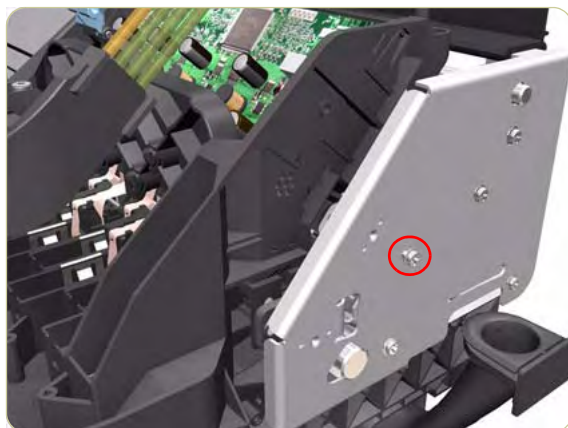

**11.** Remove one T-15 screw (**Type A**) that secures the Belt Tensioner to the Chassis.

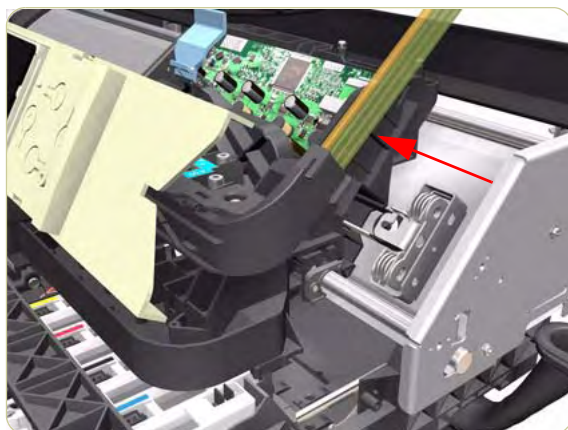

**12.** Move the Carriage Assembly slightly away from the right Scan-Axis Bracket.



- 13.** Release the Carriage Belt from the Scan-Axis Motor on the left hand side of the Printer.

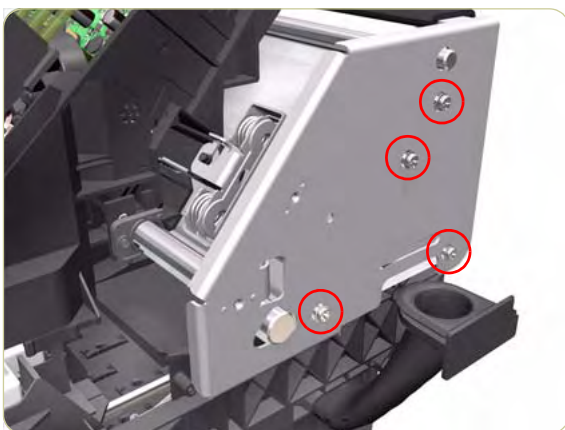

- 14.** Remove four T-20 screws (**Type N**) that secure the right Scan-Axis Bracket.

**Note that these are Chassis screws and in normal circumstances should NEVER be removed, but in this case we need to remove them in order to remove the Carriage Assembly.**

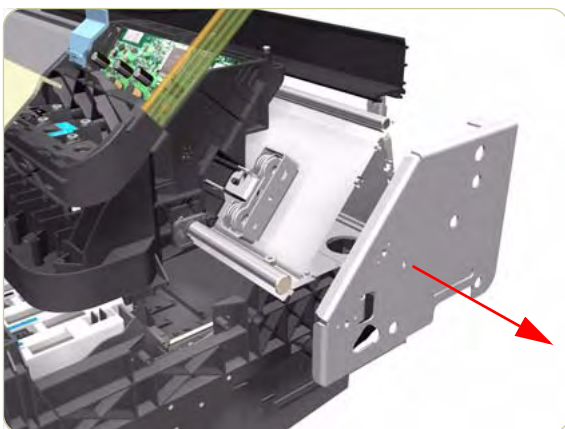

- 15.** Remove the right Scan-Axis Bracket from the Printer.

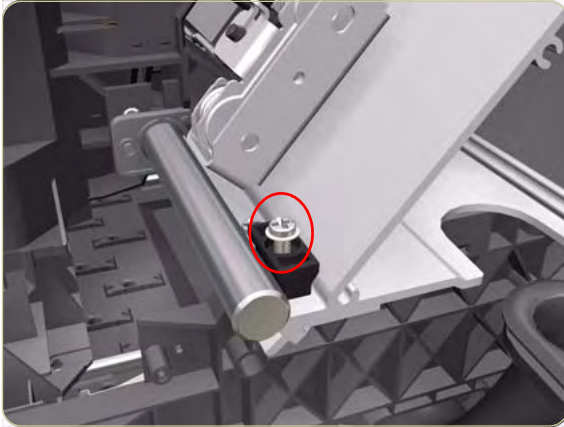

- 16.** Remove the Carriage Stopper Screw (T-25) from the Chassis.

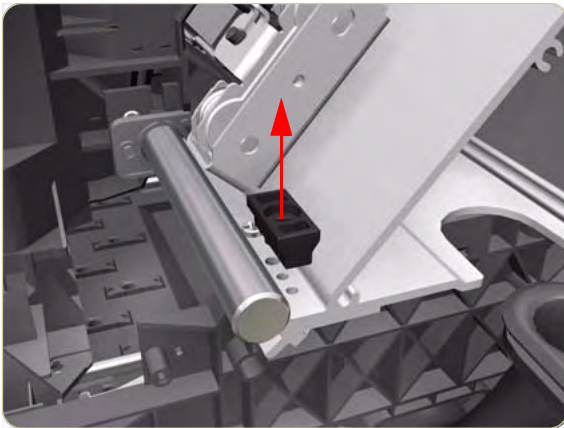

- 17.** Remove the Carriage Stopper from the Printer.

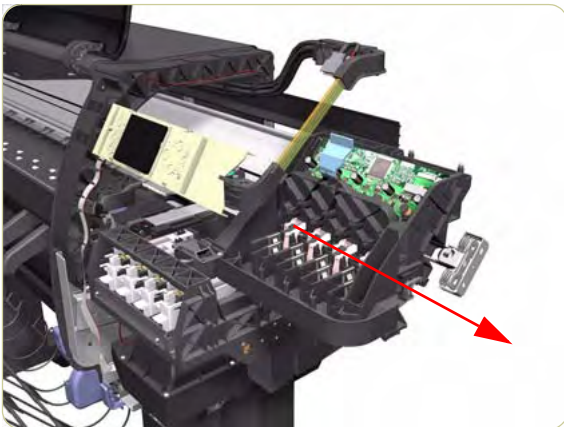

- 18.** Slide the Carriage Assembly (including the belt) to the right and out of the Printer.
- 19.** If the Carriage Assembly is to be replaced, make sure that you remove the Belt, the Carriage PCA, Encoder and Line Sensors (in order to install them on the new Carriage Assembly).

**After installing the NEW Carriage Assembly, make sure you perform the following Service Utility:**

- Reset life counter Carriage ME ⇒ Chapter 4.

**After installing the NEW Carriage Assembly, make sure you perform the following Service Calibrations:**

- Scan-Axis Calibration ⇒ Chapter 5.
- Service Station Calibration ⇒ Chapter 5.
- Line Sensor Calibration ⇒ Chapter 5.

## Belt Assembly

### Removal

**Switch off the product and remove the power cable.**

1. Remove the Right Cover ⇒ Page 8-6.
2. Remove the Left Cover ⇒ Page 8-9.
3. Remove the Top Cover ⇒ Page 8-11.
4. Remove the Encoder Strip ⇒ Page 8-45.
5. Remove the Carriage Assembly ⇒ Page 8-53.
6. Release the Belt from the bottom of the Carriage Assembly.

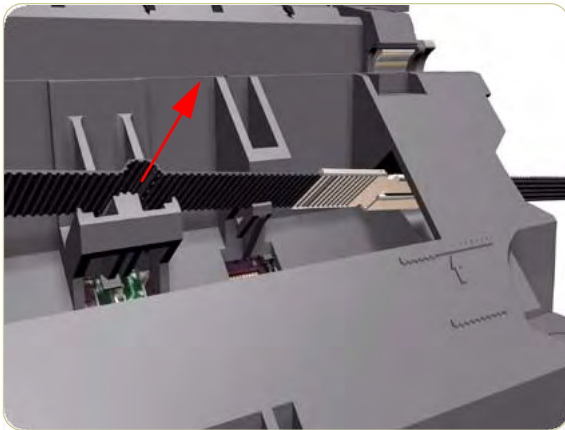

**After installing the NEW Belt Assembly, make sure you perform the following Service Utility:**

- Reset life counter scan cycles belt ⇒ Chapter 4.

## Scan-Axis Motor

### Removal

**Switch off the product and remove the power cable.**

1. Remove the Right Cover ⇒ Page 8-6.
2. Remove the Left Cover ⇒ Page 8-9.
3. Remove the Rear Door ⇒ Page 8-16.
4. Remove the Left Connector Cover ⇒ Page 8-19
5. Remove one T-15 screw that secures the Belt Tensioner to the Chassis.

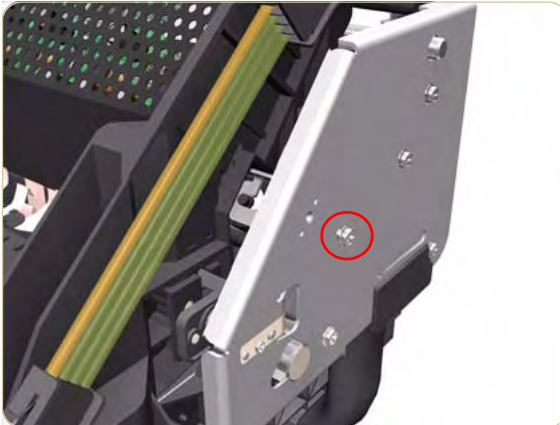

6. Move the Carriage Assembly slightly away from the right Scan-Axis Bracket.

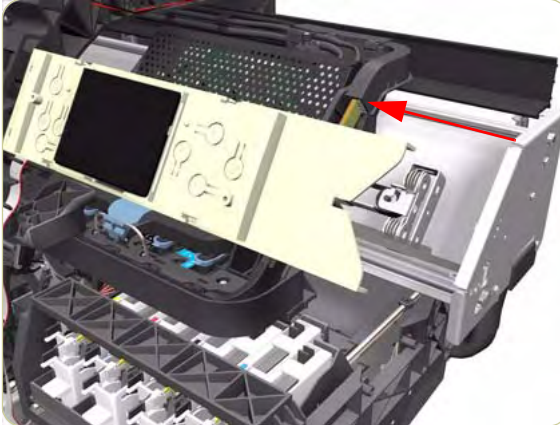



7. Release the Carriage Belt from the Scan-Axis Motor on the left hand side of the Printer.

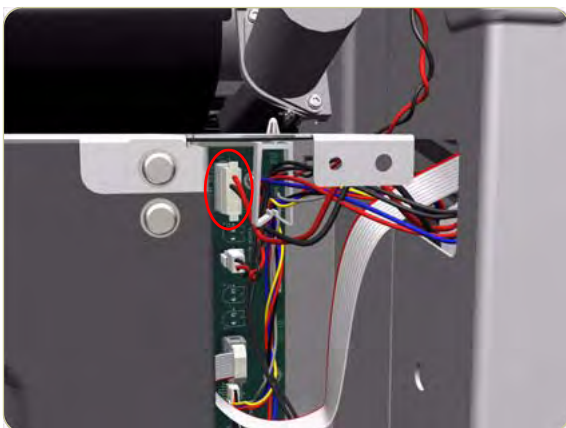

8. Disconnect the Scan-Axis Motor cable from the PrintMech PCA.

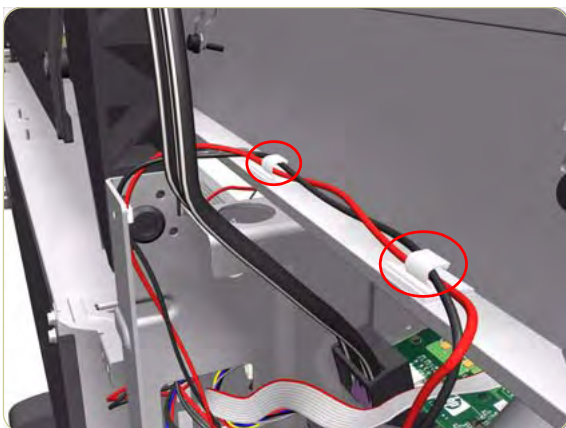

9. Release the Scan-Axis Motor cable from the clips on the chassis.

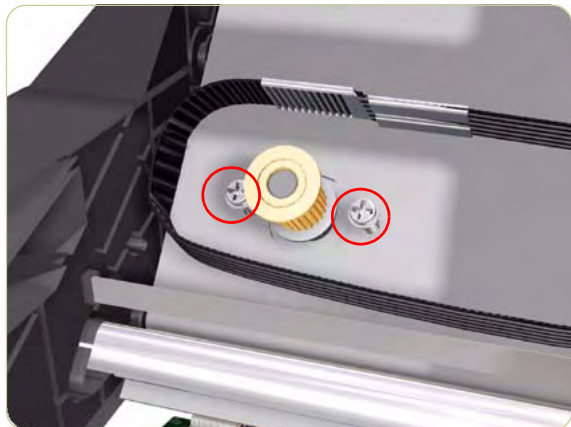

- 10.** Remove two T-20 screws (**Type A**) that secure the Scan-Axis Motor.

**Make sure you hold the Scan-Axis Motor securely when removing the screws.**

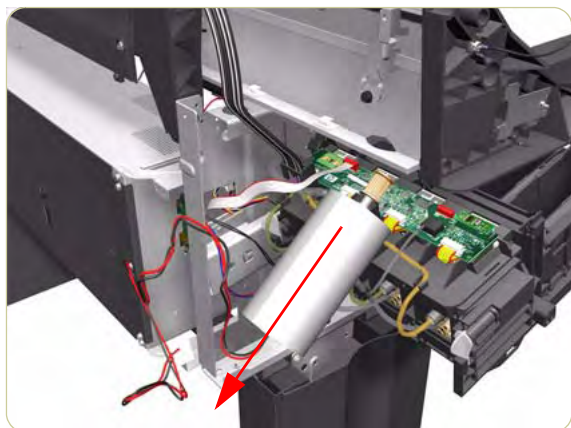

- 11.** Remove the Scan-Axis Motor from the Printer.

**After installing the NEW Scan-Axis Motor, make sure you perform the following Service Utility:**

- Reset life counter scan motor ⇒ Chapter 4.

## Media-Axis Motor

### Removal

Switch off the product and remove the power cable.

1. Remove the Rear Door ⇒ Page 8-16.
2. Remove the Left Connector Cover ⇒ Page 8-19.
3. Disconnect the Media-Axis Motor cable from the PrintMech PCA.

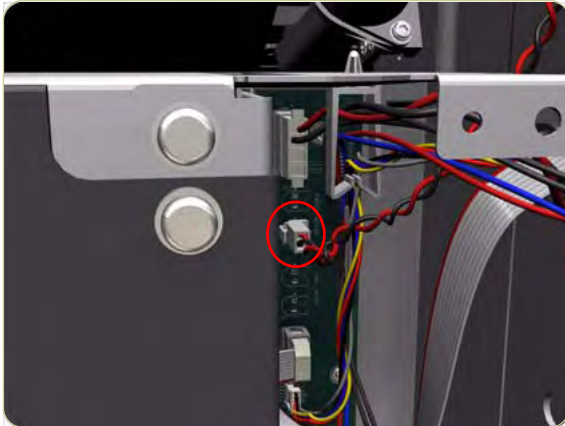

4. Remove two T-15 screws (**Type R**) that secure the Media-Axis Motor.

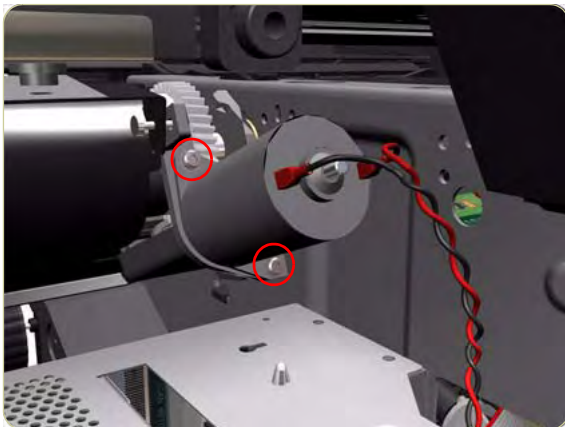

5. Loosen two T-20 screws (**Type B**) that secure the Media-Axis Motor Bracket.

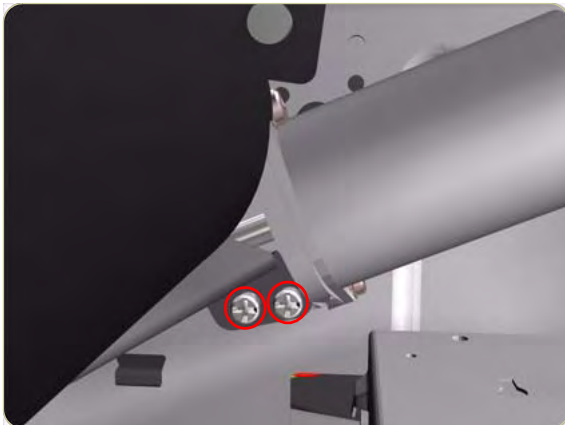



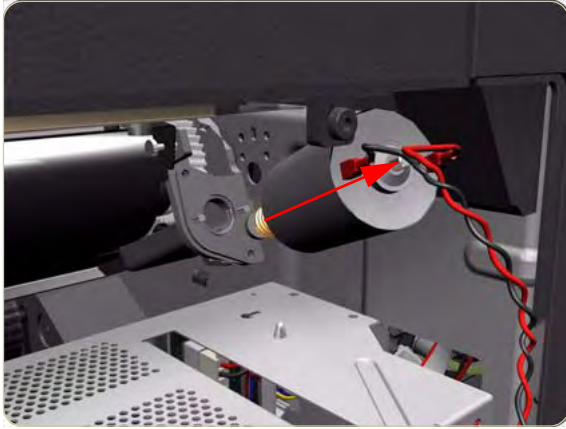

6. Remove the Media-Axis Motor from the Printer.

**When reinstalling the parts, make sure you apply the grease (included with the support part) to the gears.**

**After installing the NEW Media-Axis Motor, make sure you perform the following Service Calibration:**

- Paper Advance Calibration ⇒ Chapter 5.

## Interconnect PCA

### Removal

Switch off the product and remove the power cable.

1. Remove the Rear Door ⇒ Page 8-16.
2. Remove the Left Connector Cover ⇒ Page 8-19.
3. Remove the JetDirect Card (if installed).

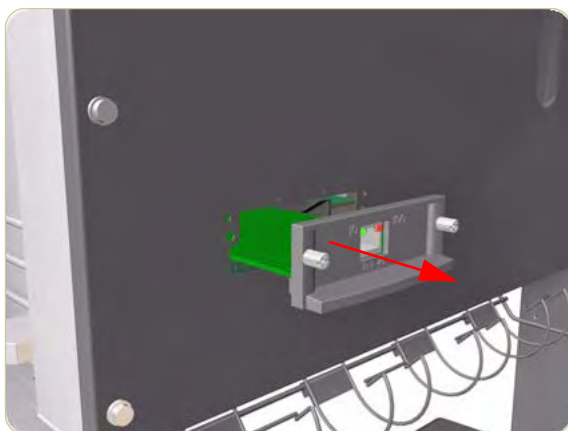

4. Remove three T-15 screws (**Type A**) that secure the Main PCA cover.

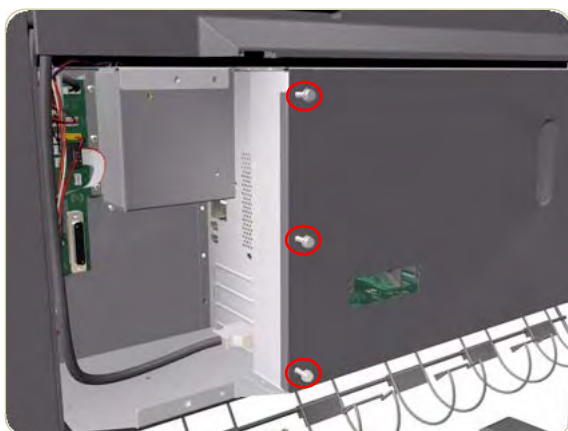

5. Remove the Main PCA Cover from the Printer.

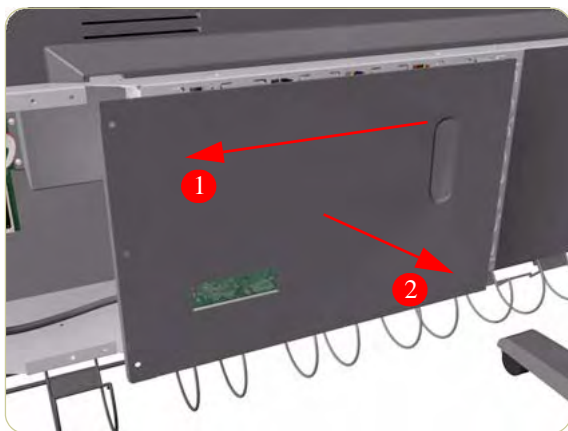

I

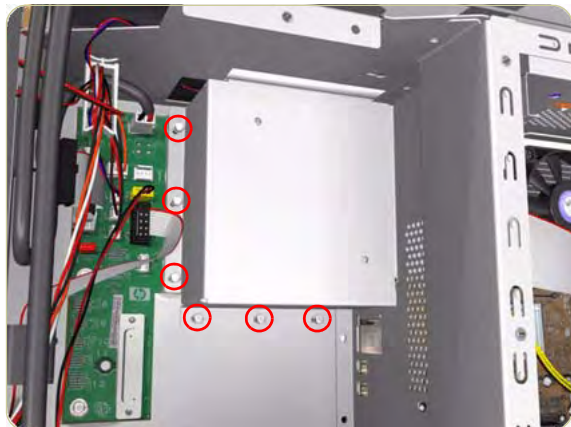

6. Remove six T-10 screws (**Type I**) that secure the Interconnect PCA Cover.

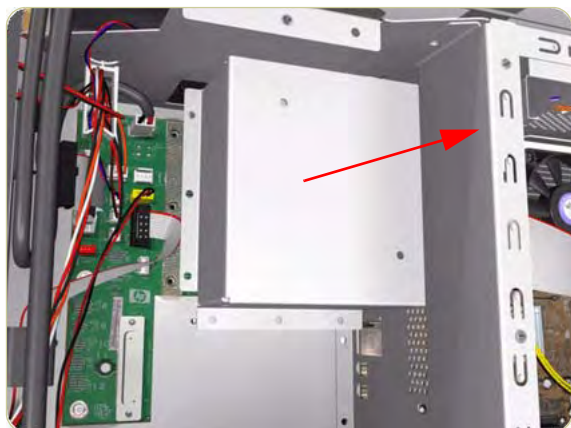

7. Remove the Interconnect PCA Cover from the Printer.

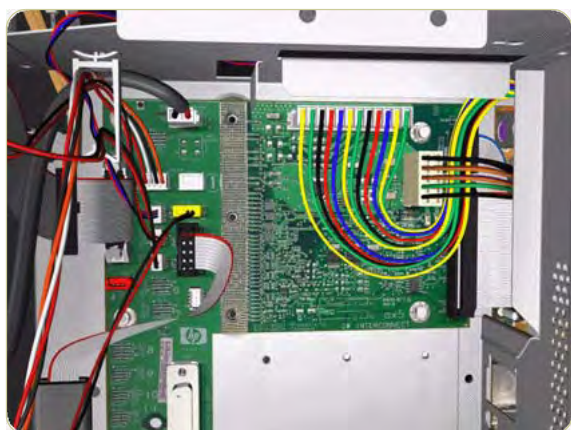

8. Disconnect ALL cables from the Interconnect PCA.

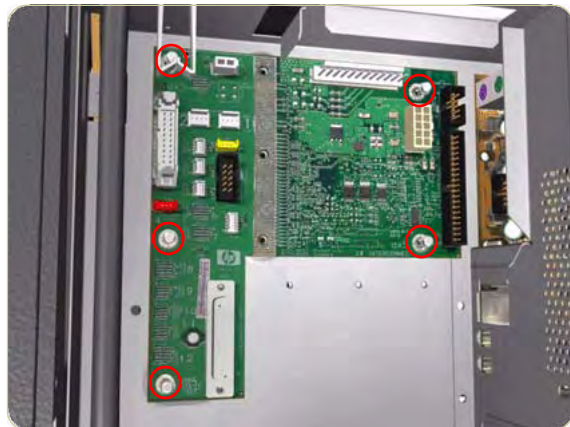

**9.** Remove five T-10 screws (**Type I**) that secure the Interconnect PCA.

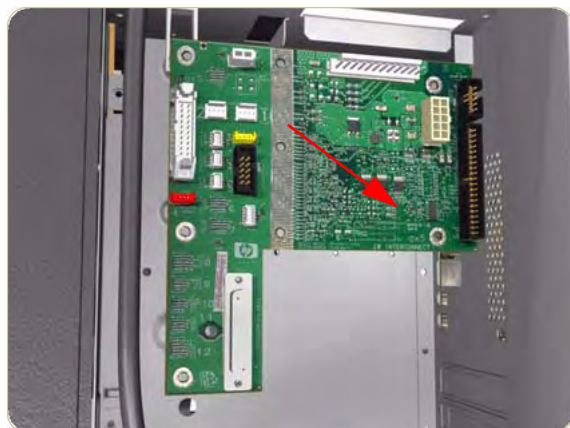

**10.** Remove the Interconnect PCA from the Printer.

## EIO to PCA Interface Card

### Removal

Switch off the product and remove the power cable.

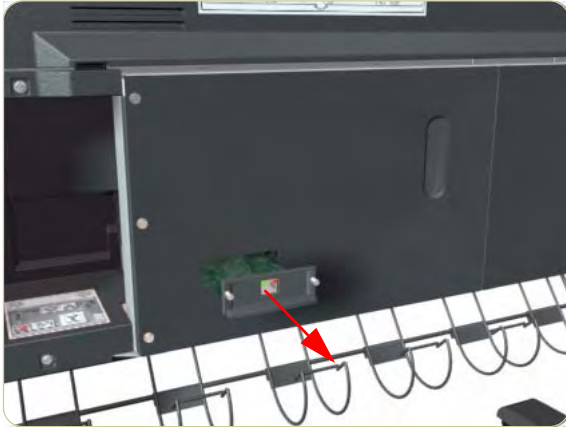

1. Remove the JetDirect Card (if installed).

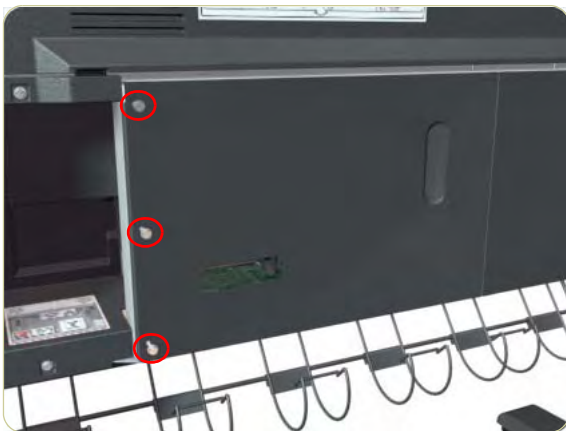

2. Remove three T-15 screws (**Type A**) that secure the Main PCA cover.

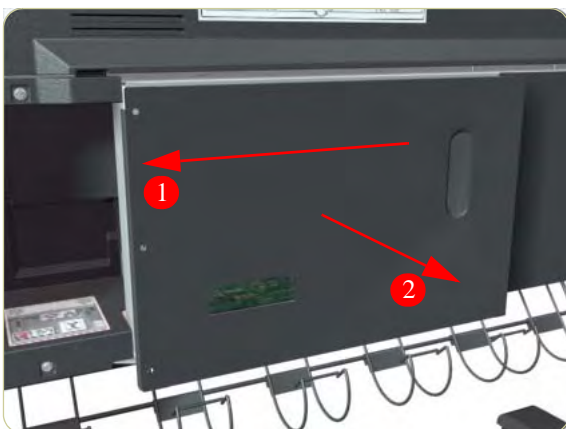

3. Remove the Main PCA Cover from the Printer.

I

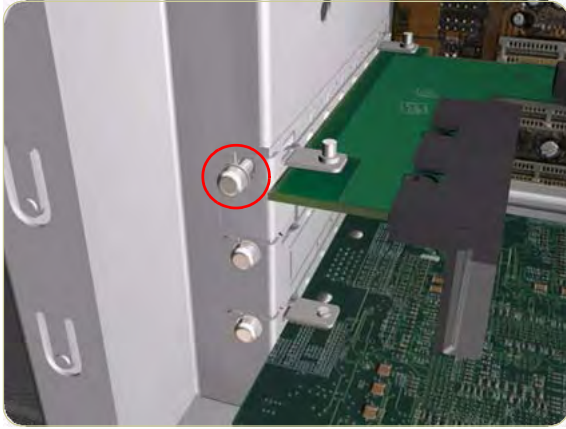

4. Remove one T-10 screw (**Type I**) that secures the Interface Card.

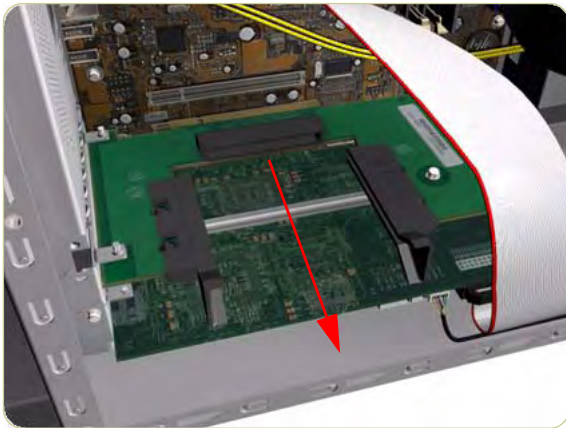

5. Disconnect the Interface Card from the Main PCA and remove from the Printer.

## Gamut PCI PCA

### Removal

**Switch off the product and remove the power cable.**

1. Remove the Rear Door ⇒ Page 8-16.
2. Remove the Left Connector Cover ⇒ Page 8-19.
3. Remove the JetDirect Card (if installed).

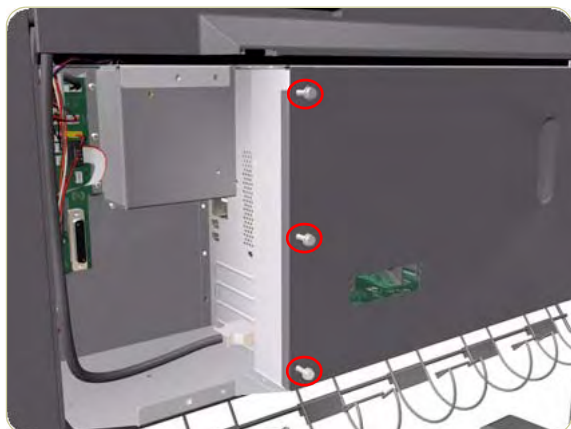
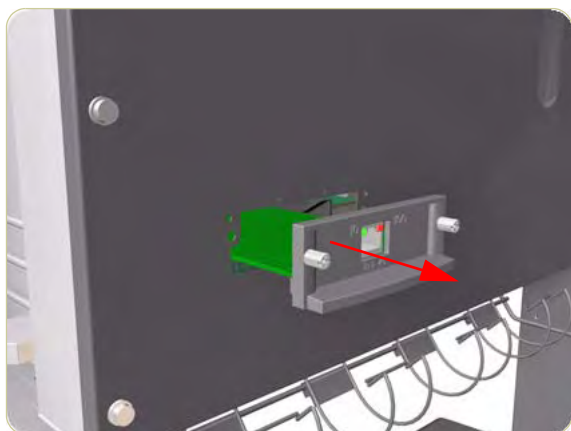

4. Remove three T-15 screws (**Type A**) that secure the Main PCA cover.

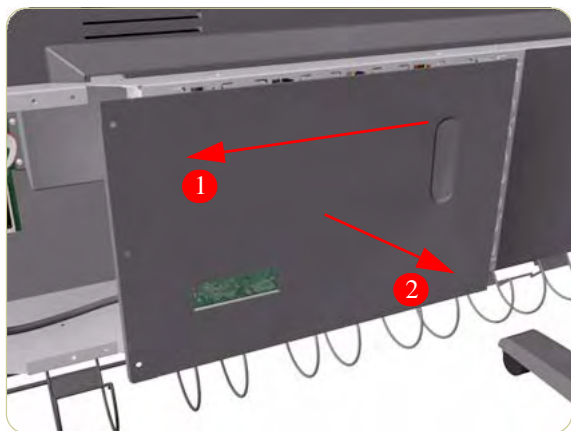

5. Remove the Main PCA Cover from the Printer.



6. Disconnect the Trailing Cable from the Gamut PCI PCA.

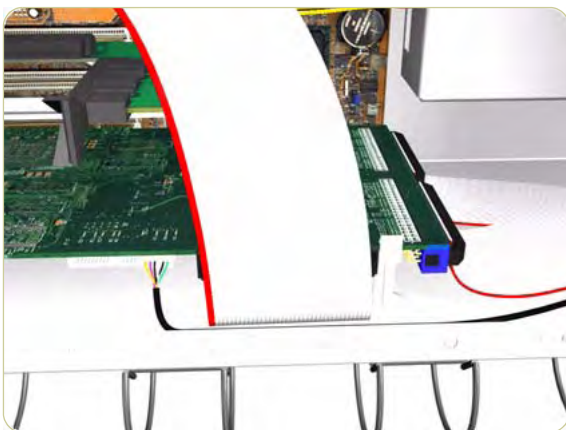

7. Disconnect ALL cables connected to the Gamut PCI PCA.

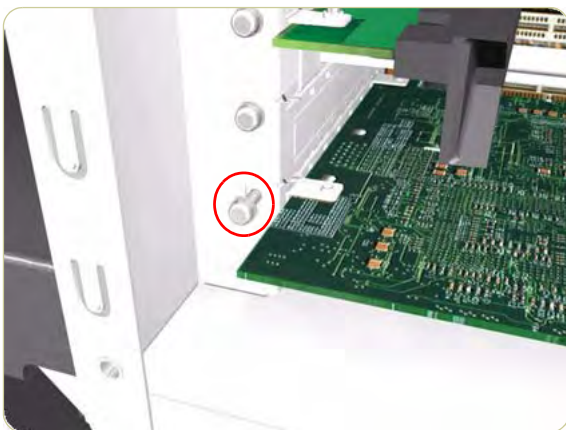

8. Remove one T-10 screw (**Type I**) that secures the Gamut PCI PCA.



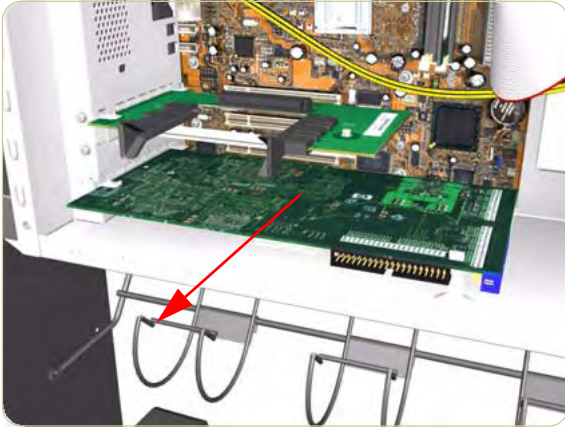

9. Disconnect the Gamut PCI PCA from the Main PCA and remove from the Printer.

## Memory Module

### Removal

Switch off the product and remove the power cable.



1. Remove the JetDirect Card (if installed).



2. Remove three T-15 screws (**Type A**) that secure the Main PCA cover.

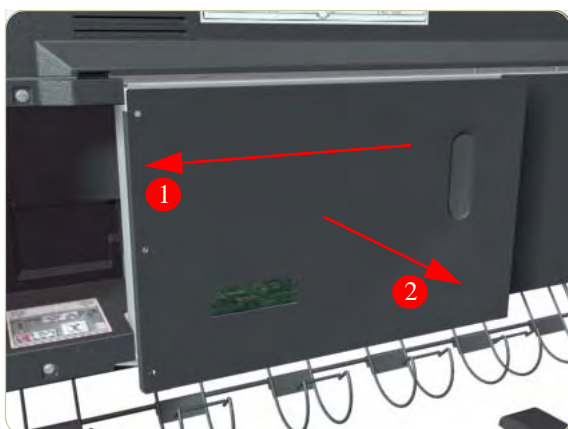

3. Remove the Main PCA Cover from the Printer.

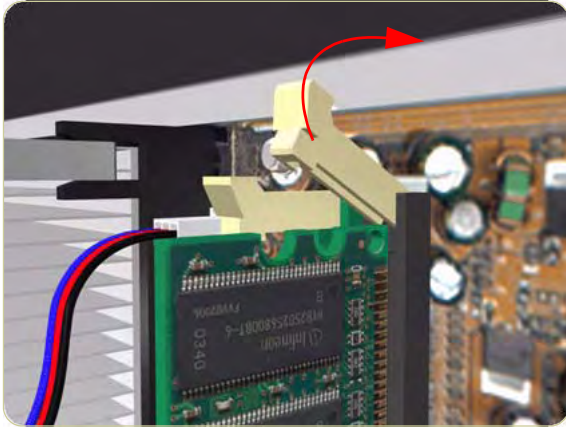

4. Push the Memory Module Connector clips up and down to release the Memory Module.

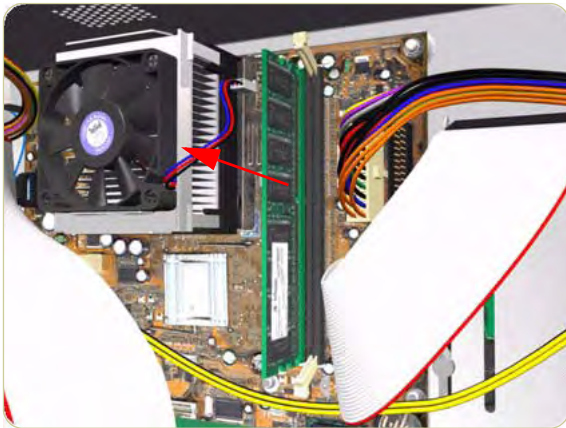

5. Remove the Memory Module from the Printer.

## Main PCA Formatter

### Removal

Switch off the product and remove the power cable.

**Do NOT remove the Fan or the Processor (located under the Fan) from the Main PCA Formatter - The Fan and the Processor are part of the Main PCA Formatter support part and should be replaced as one assembly.**

1. Remove the EIO to PCI Interface Card ⇒ Page 8-67.
2. Remove the Gamut PCI PCA ⇒ Page 8-69.
3. Remove the Memory Module ⇒ Page 8-72.
4. Disconnect ALL cables connected to the Main PCA Formatter.

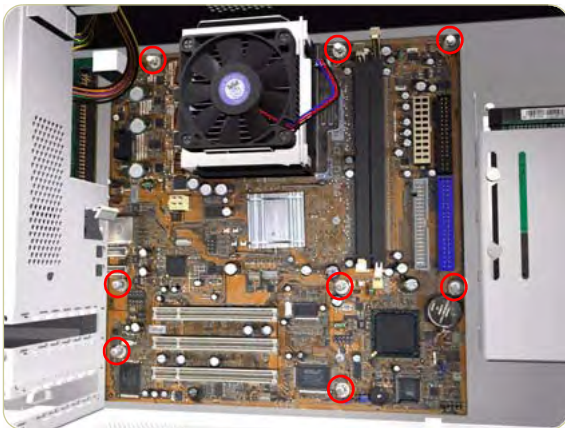
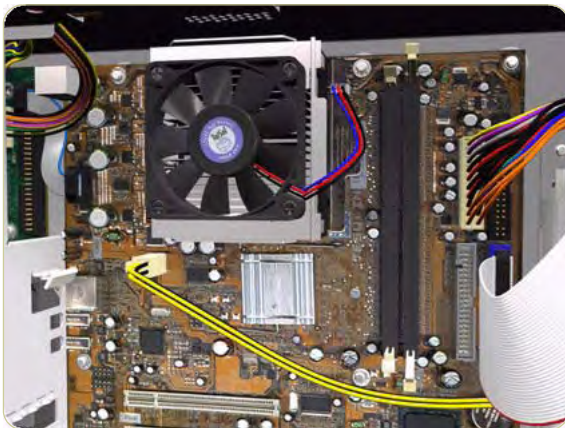

5. Remove eight T-10 screws (**Type I**) that secure the Main PCA Formatter.

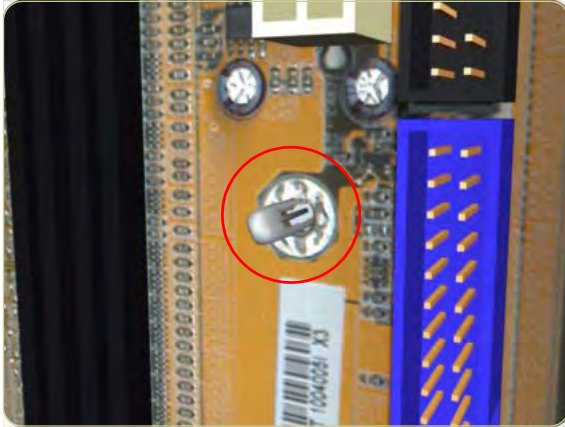

6. Release the plastic locating pin that secures the Main PCA Formatter.

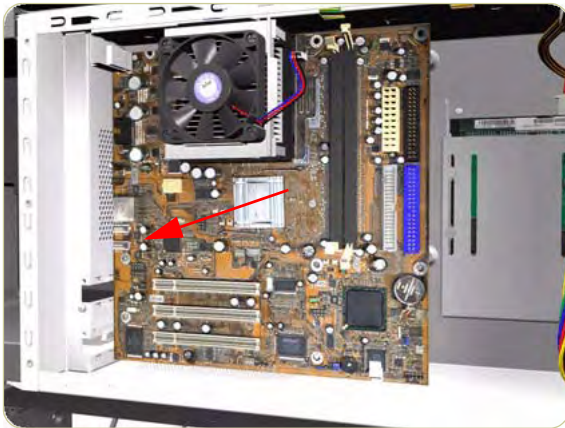

7. Remove the Main PCA Formatter from the Printer.

**When installing the Main PCA Formatter, make sure that you first locate it on the plastic locating pin and then install the screws.**

## Hard Disk Drive (HDD)

### Removal

Switch off the product and remove the power cable.

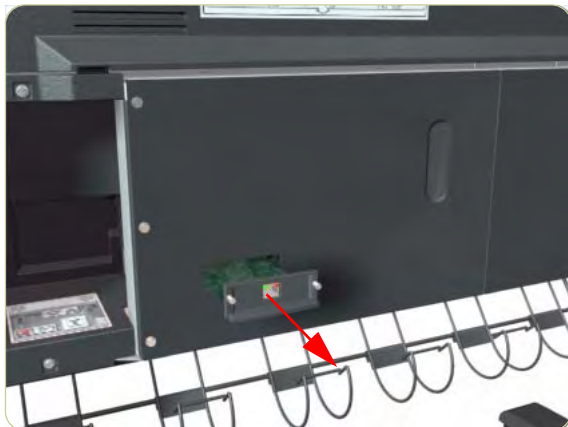

1. Remove the JetDirect Card (if installed).



2. Remove three T-15 screws (**Type A**) that secure the Main PCA cover.

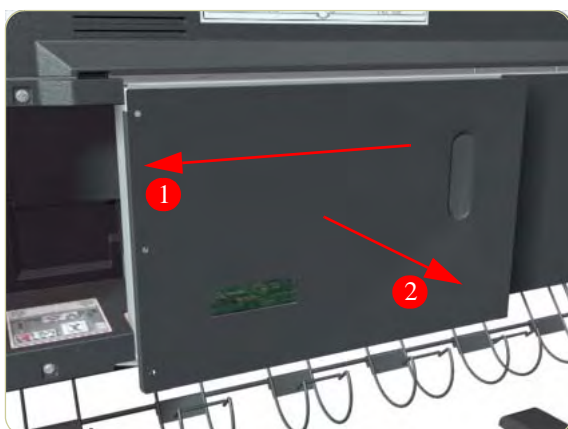

3. Remove the Main PCA Cover from the Printer.

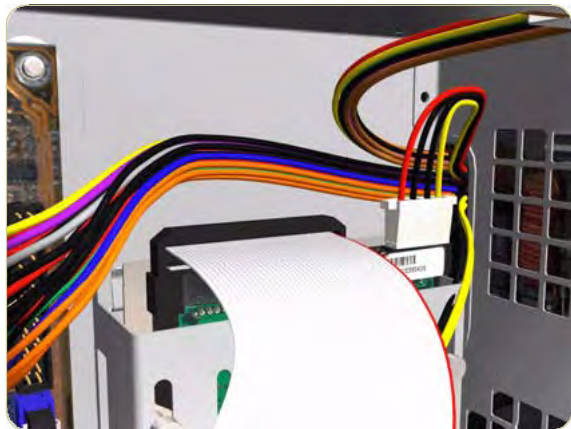

4. Disconnect ALL cables connected to the Hard Disk Drive.

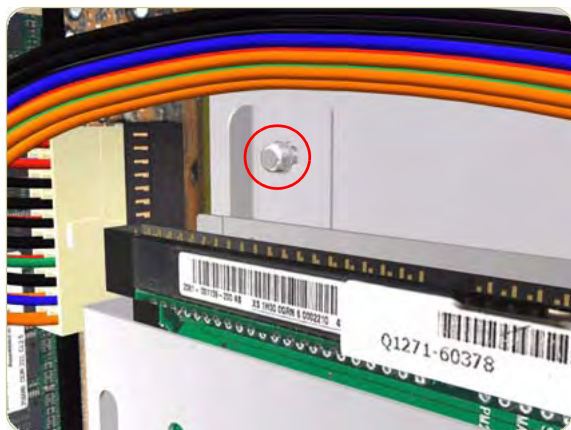

5. Remove one T-10 screw (**Type I**) from the HDD Holder.

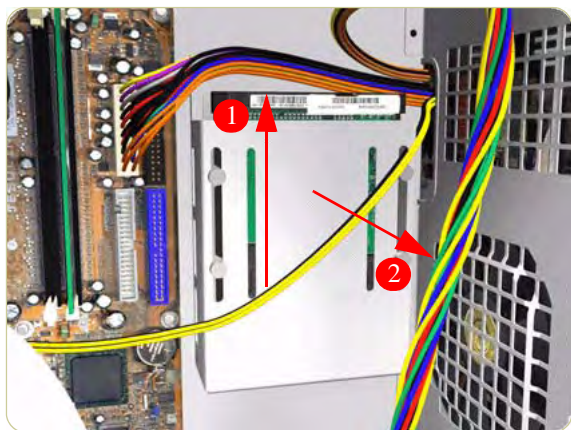

6. Slide the Hard Disk Drive upwards and remove from the Printer.

**It is not necessary to remove the screws securing the HDD inside the metal casing.**

**After installing the NEW HDD, make sure you perform the following User Calibrations:**

- Printhead Alignment.
- Paper Advance Calibration.
- Color Calibration.

**After installing the NEW HDD, make sure you perform the following Service Utility:**

- Carriage PCA Setup ⇒ Chapter 4.

**You MUST NEVER replace both the Hard Disk Drive and the Ink Supply Tubes and Trailing Cable at the same time. If both parts need to be replaced, you MUST first replace one part and then power ON the Printer until it completely initializes. Then you can power OFF the Printer and replace the other part.**

## Power Supply Unit (PSU)

### Removal

Switch off the product and remove the power cable.

1. Remove the Right Connector Cover ⇒ Page 8-18.
2. Remove the JetDirect Card (if installed).

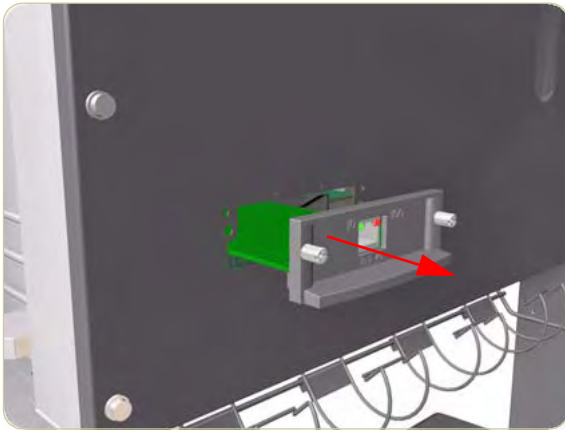

3. Remove three T-15 screws (**Type A**) that secure the Main PCA cover.

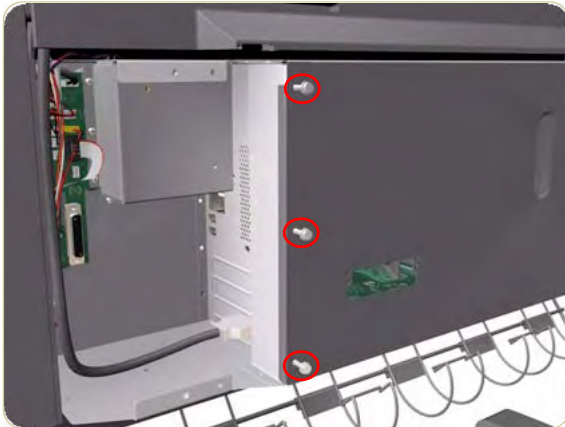

4. Remove the Main PCA Cover from the Printer.

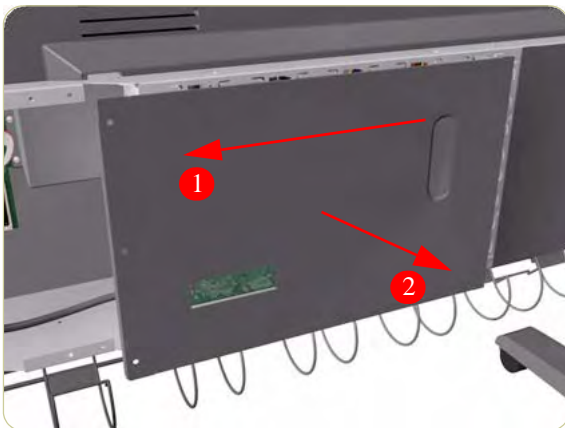

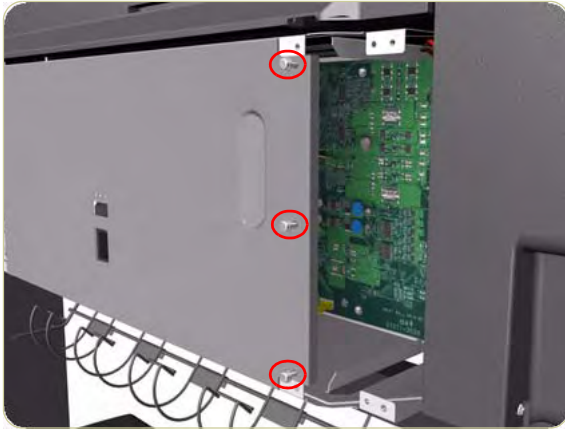

**I**

5. Remove three T-15 screws (**Type A**) that secure the PSU cover.

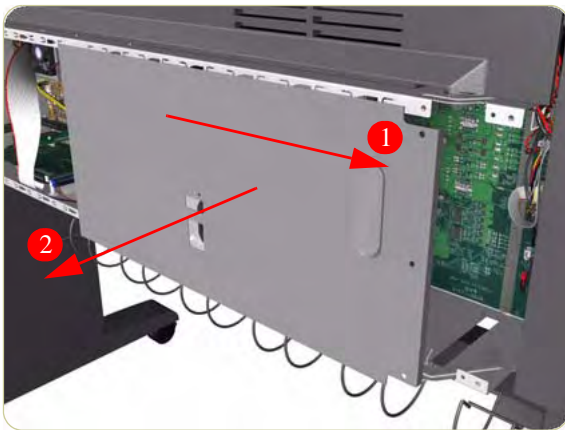

6. Remove the PSU Cover from the Printer.

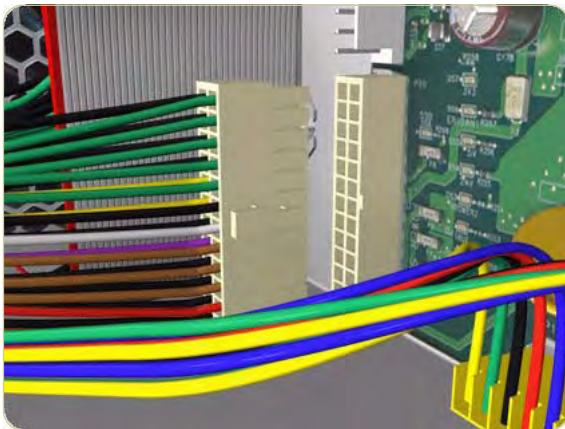

7. Disconnect the Power Supply and Interconnect cables from the PrintMech PCA.

I

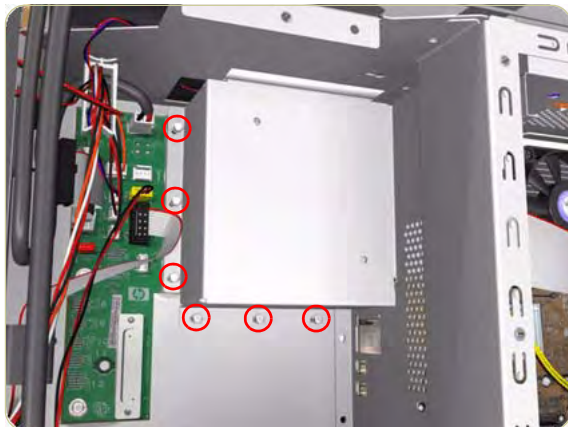

8. Remove six T-10 screws (**Type I**) that secure the Interconnect PCA Cover.

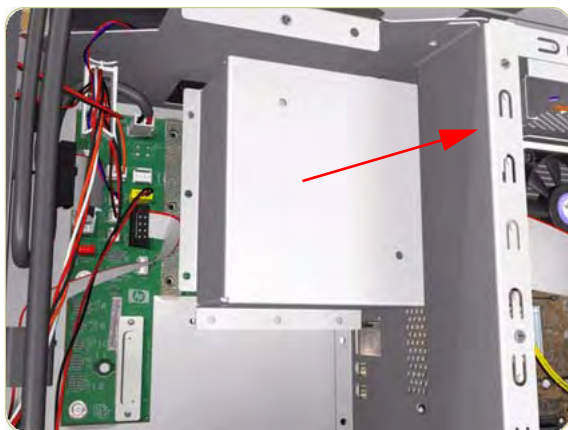

9. Remove the Interconnect PCA Cover from the Printer.

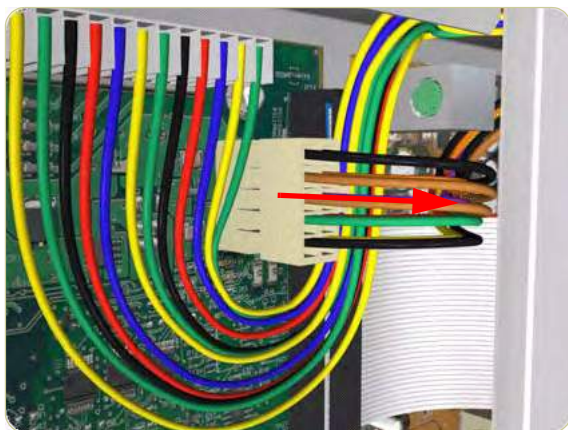

10. Disconnect one cable from the Interconnect PCA.

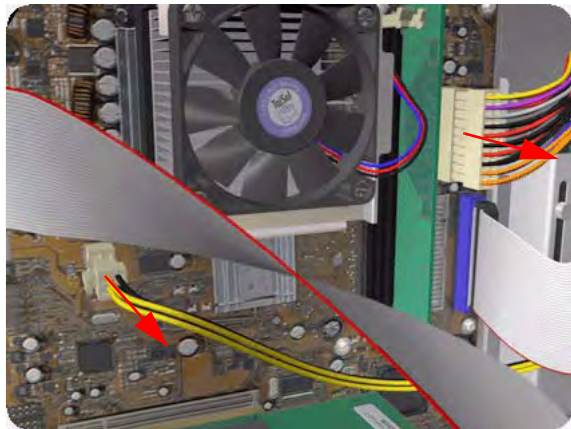

**11.** Disconnect two cables from the Main PCA.

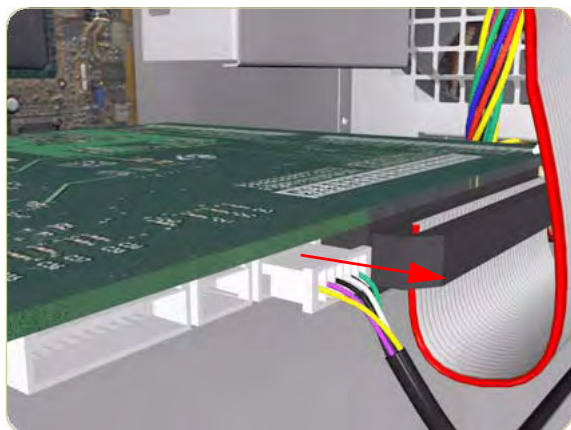

**12.** Disconnect one cable from the Gamut PCA.

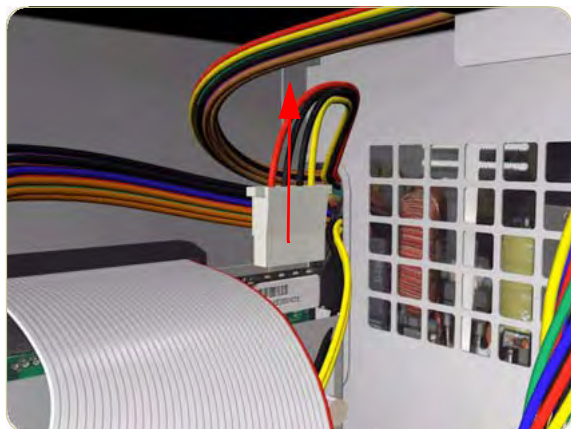

**13.** Disconnect one cable from Hard Disk Drive.



**14.** Bend the edge of the Cable Support Bracket so that it can be released.

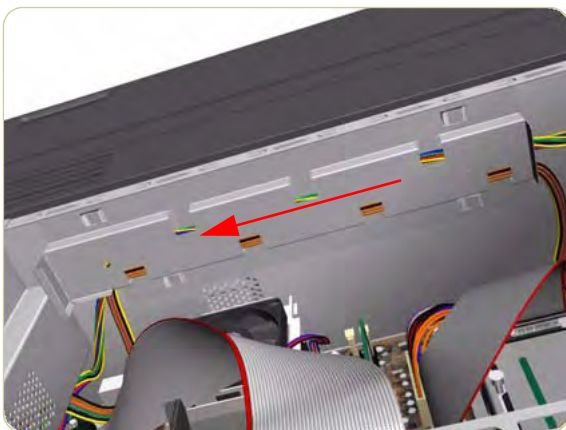

**15.** Move the Cable Support Bracket to the left to release it from the Electronics Module.

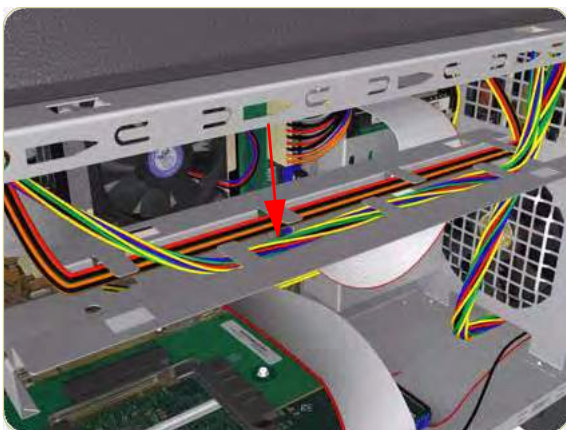

**16.** Lower the Cable Support Bracket so that the cables can be accessed.

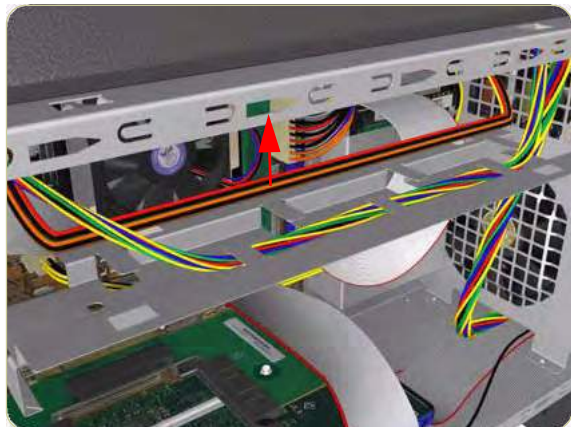

**17.** Release the Power Supply Cable from the Cable Support Bracket.



**18.** Remove four T-10 screws (**Type I**) that secure the Power Supply Unit.

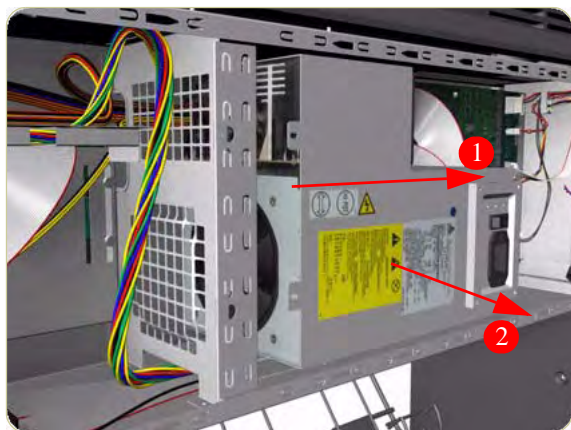

**19.** Route the cables through the hole in the Electronics Module and remove the Power Supply Unit from the Printer.

## PrintMech PCA

### Removal

Switch off the product and remove the power cable.

1. Remove the Left Connector Cover ⇒ Page 8-19.
2. Remove three T-15 screws (**Type A**) that secure the PSU cover.

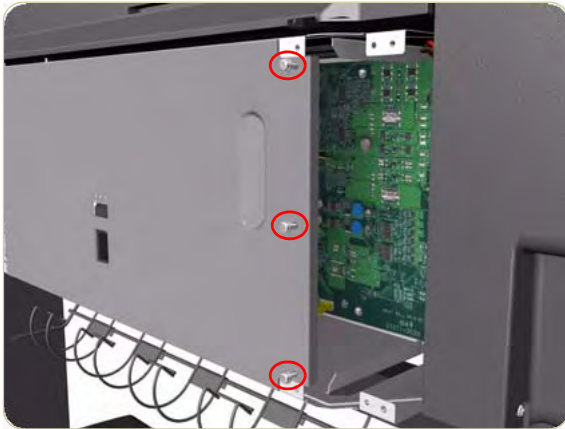

3. Remove the PSU Cover from the Printer.

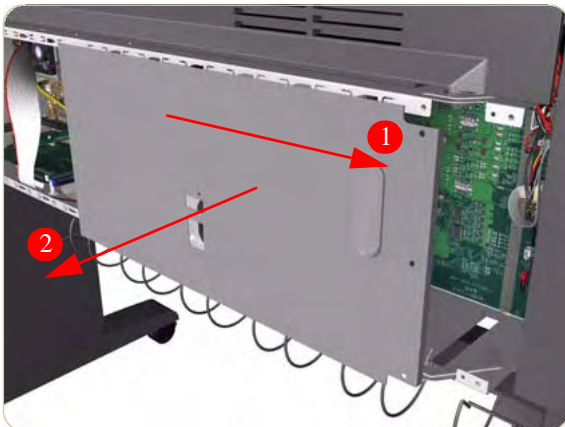

4. Disconnect ALL cables from the PrintMech PCA.



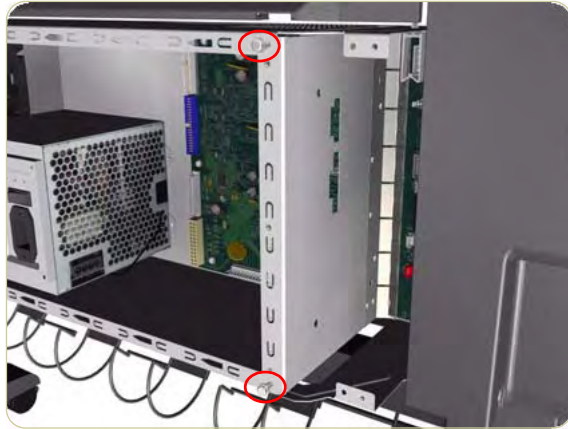

5. Remove two T-15 screws (**Type B**) that secure the PrintMech Cover.

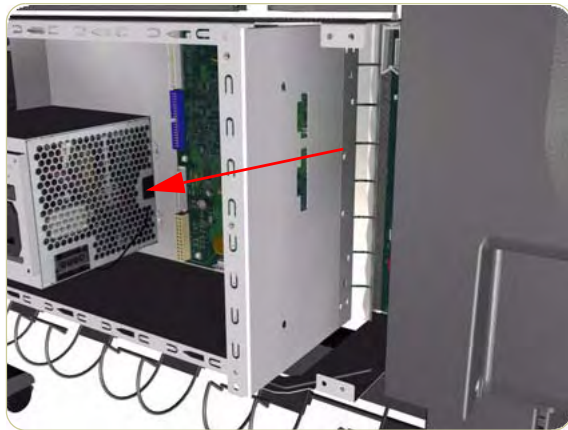

6. Slide the PrintMech Cover out of the Printer.

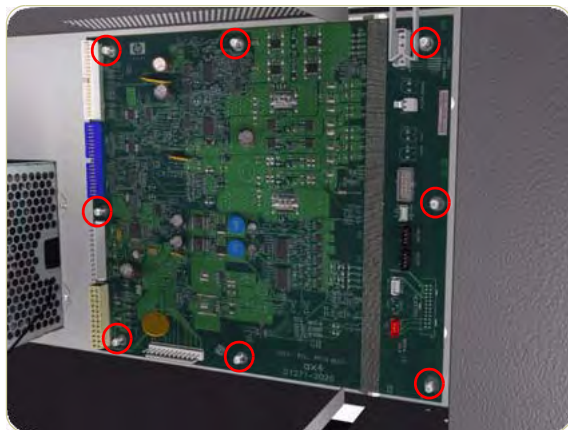

7. Remove eight T-10 screws (**Type I**) that secure the PrintMech PCA.

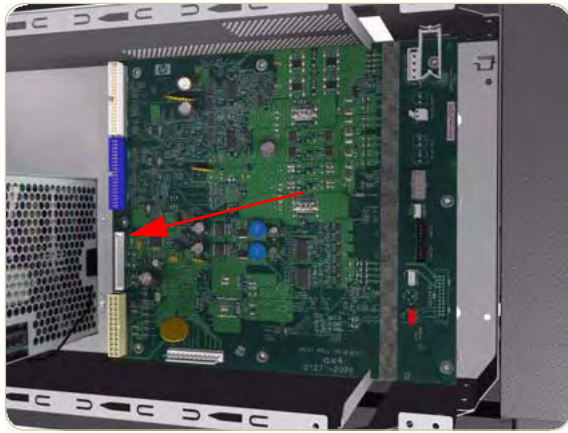

8. Remove the PrintMech PCA from the Printer.



## Formatter Battery

### Removal

Switch off the product and remove the power cable.

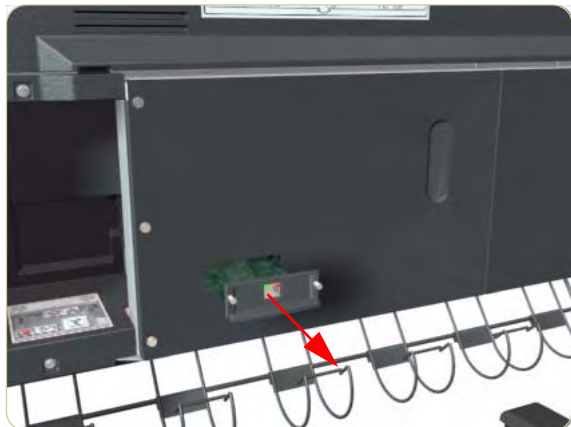

1. Remove the JetDirect Card (if installed).



2. Remove three T-15 screws (**Type A**) that secure the Main PCA cover.

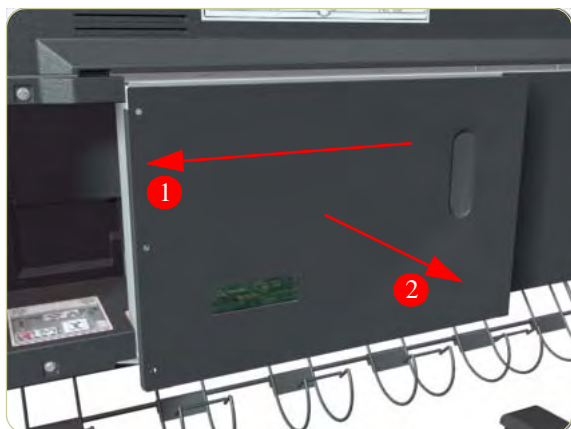

3. Remove the Main PCA Cover from the Printer.



4. Push the clip down and release the battery from the Main PCA.

## Line Sensor Assembly

### Removal

Switch off the product and remove the power cable.

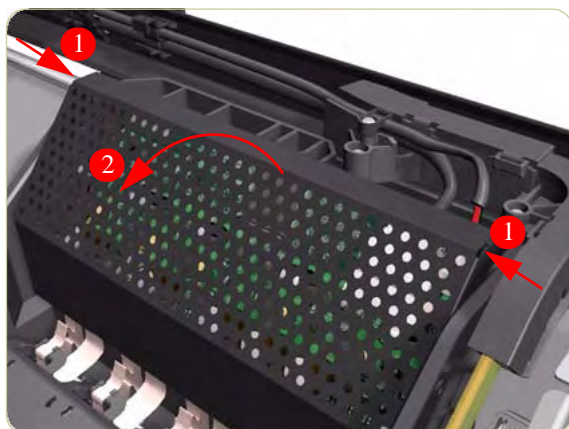

1. Remove the Right Cover ⇒ Page 8-6.
2. Press the two side of the Carriage PCA Cover and unclip from the Carriage Assembly.

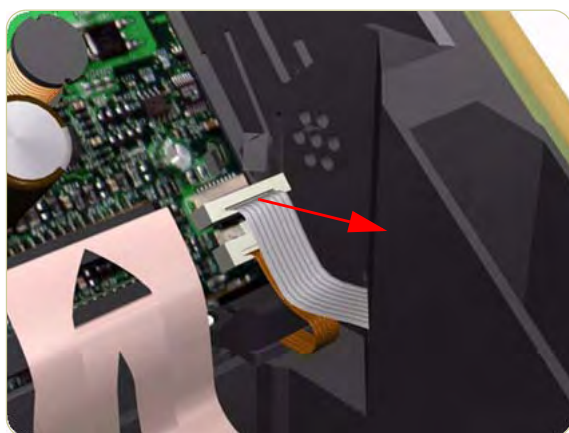

3. Release the clip and disconnect the Line Sensor cable from the Carriage PCA.

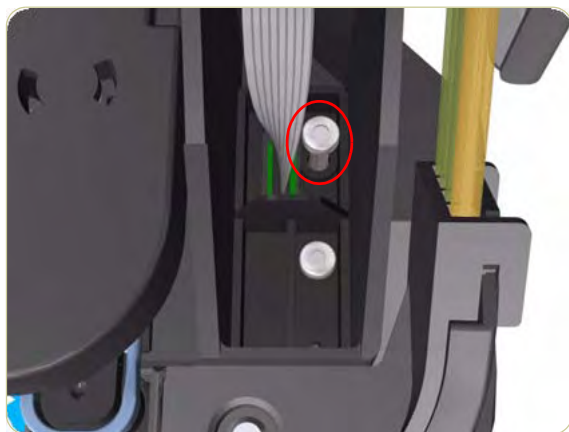

4. Remove one T-15 screw (**Type G**) that secures the Line Sensor to the carriage Assembly.

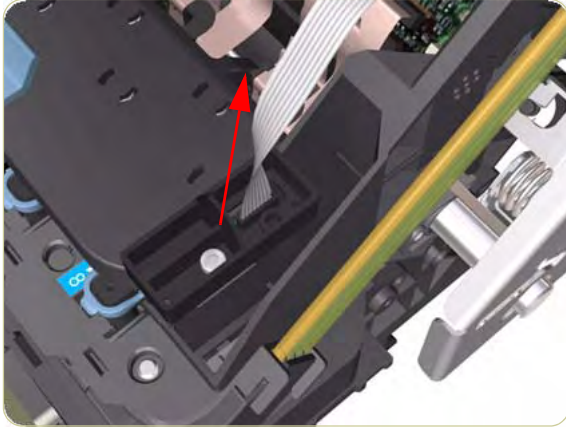

5. Remove the Line Sensor from the Carriage Assembly.

**After installing the NEW Line Sensor, make sure you perform the following Service Calibrations:**

- Line Sensor Calibration ⇒ Chapter 5.

## Media Deflector

### Removal

Switch off the product and remove the power cable.



1. Remove one T-20 screw (**Type B**) that secures the Media Deflector that needs to be replaced.



2. Release the clip securing the Media Deflector.

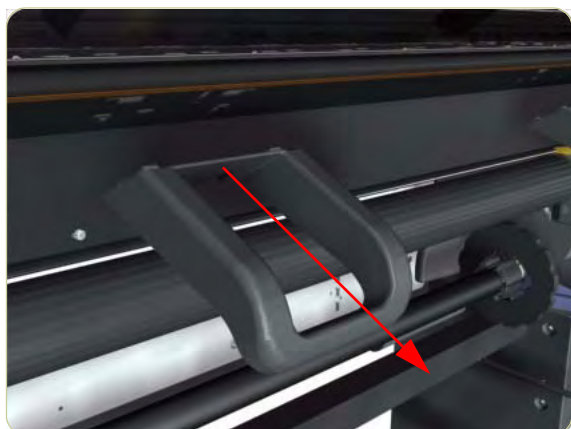

3. Remove the Media Deflector (slide upwards first) from the Printer.

## Front Platen

### Removal

Switch off the product and remove the power cable.

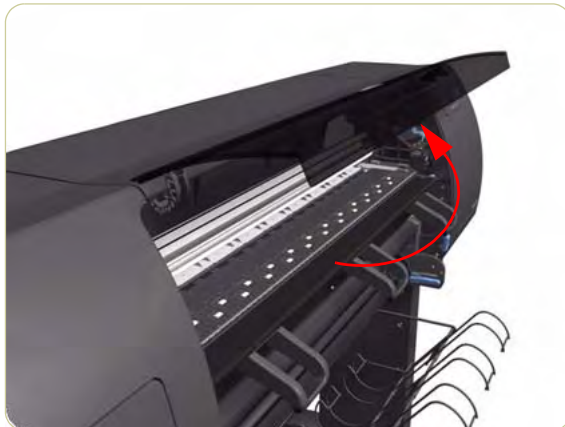

1. Open the Window.



2. Remove three T-15 screws and two cross-head screws that secure the Front Platen.

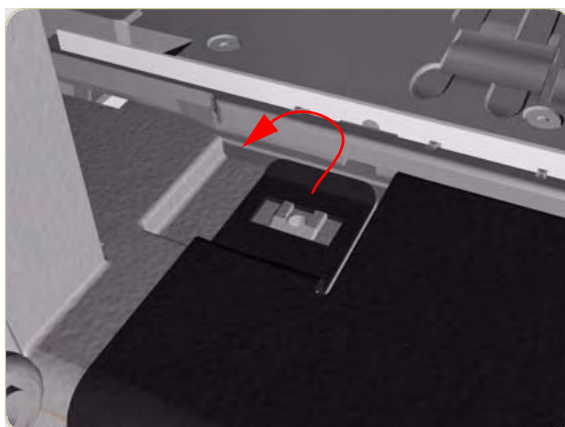

3. Release the clip on the left hand side of the Front Platen.



4. Pull out the left hand side of the Front Platen.

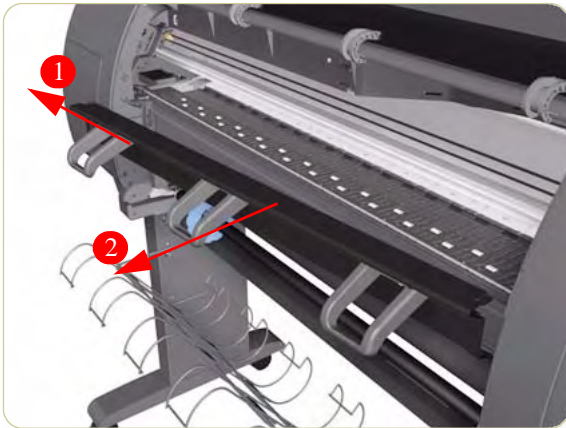

5. Slide the Front Platen to the Left and then remove from the Printer.

**If a NEW Front Platen is to be installed, make sure that you first remove ALL 3 Media Deflectors (⇒ Page 8-91) from the OLD Front Platen and install them on the New Front Platen.**

## Center Platen

### Removal

Switch off the product and remove the power cable.

1. Remove the Right Cover ⇒ Page 8-6.
2. Remove the Left Cover ⇒ Page 8-9.
3. Remove the Top Cover ⇒ Page 8-11.
4. Remove the Service Station ⇒ Page 8-23.
5. Remove the Middle Left Spittoons ⇒ Page 8-44.
6. Remove one T-15 screw (**Type P**) that secures the Center Platen Gear.

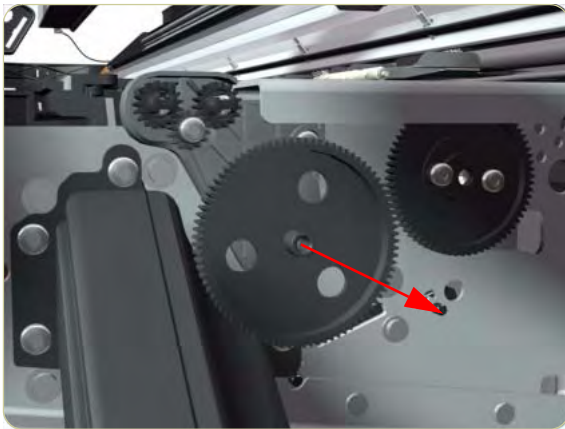

7. Remove the Center Platen Gear from the Printer.



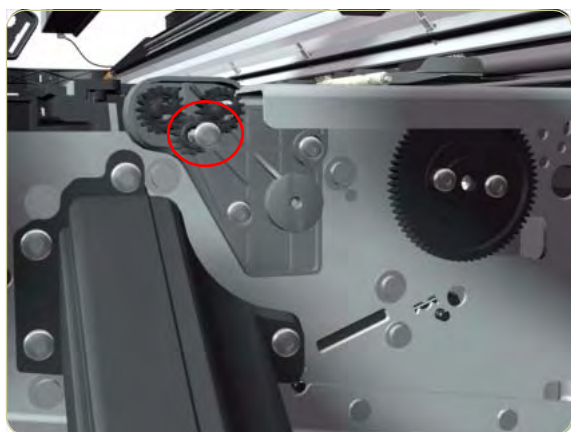

- 8.** Remove one T-15 screw that secures the small Gear.

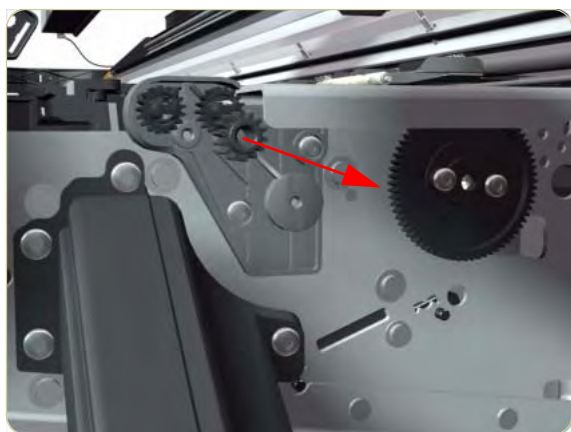

- 9.** Remove the small Gear from the Printer.

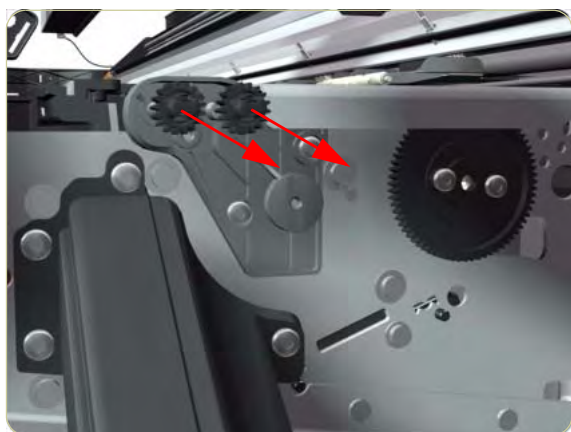

- 10.** Remove the two small Platen Gears by releasing the clips.

I

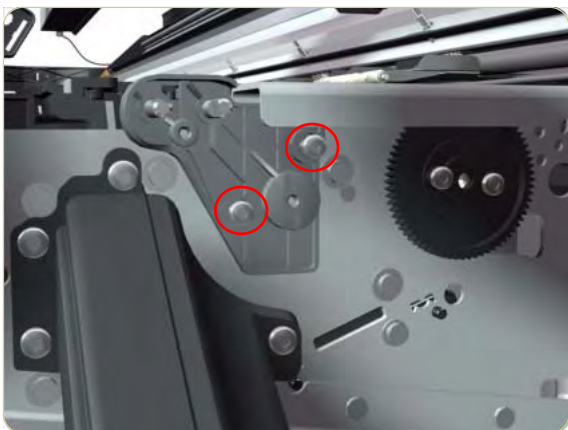

**11.** Remove two T-20 screws (**Type Q**) that secure the Gear Bracket.

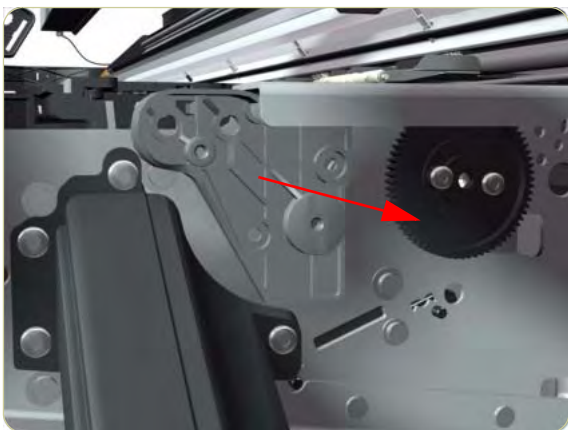

**12.** Remove the Gear Bracket from the Printer.

I

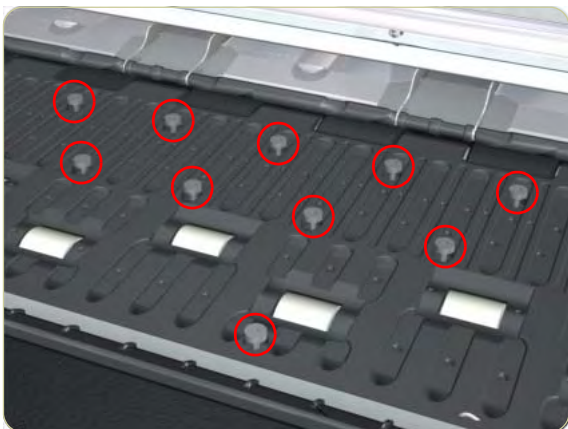

**13.** Remove 79 T-10 screws (**Type C**) that secure the Center Platen.

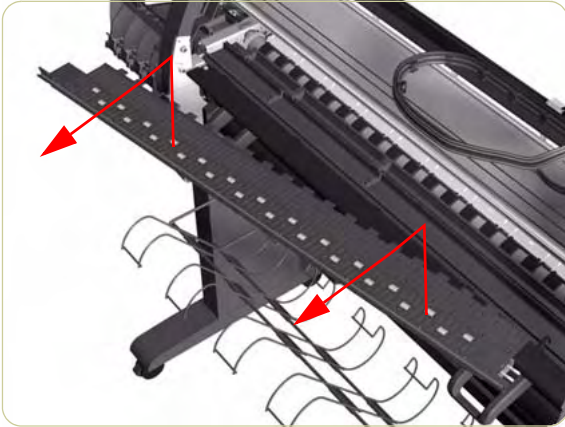

**14.** Remove the Center Platen from the Printer.

**Make sure you take note of the positions of the Foams located underneath the center Platen.**

**When reinstalling the parts, make sure you apply the grease (included with the support part) to the gears.**

**After installing the NEW Center Platen, make sure you perform the following Service Calibration:**

- Paper Advance Calibration ⇒ Chapter 5.

### Installation of the Foams

Before installing the Center Platen, make sure you check the foams that are stuck on the Vacuum Beam. These foams should ONLY be changed if they are damaged. In the circumstance where they do need to be changed, use the following illustrations to guide you:

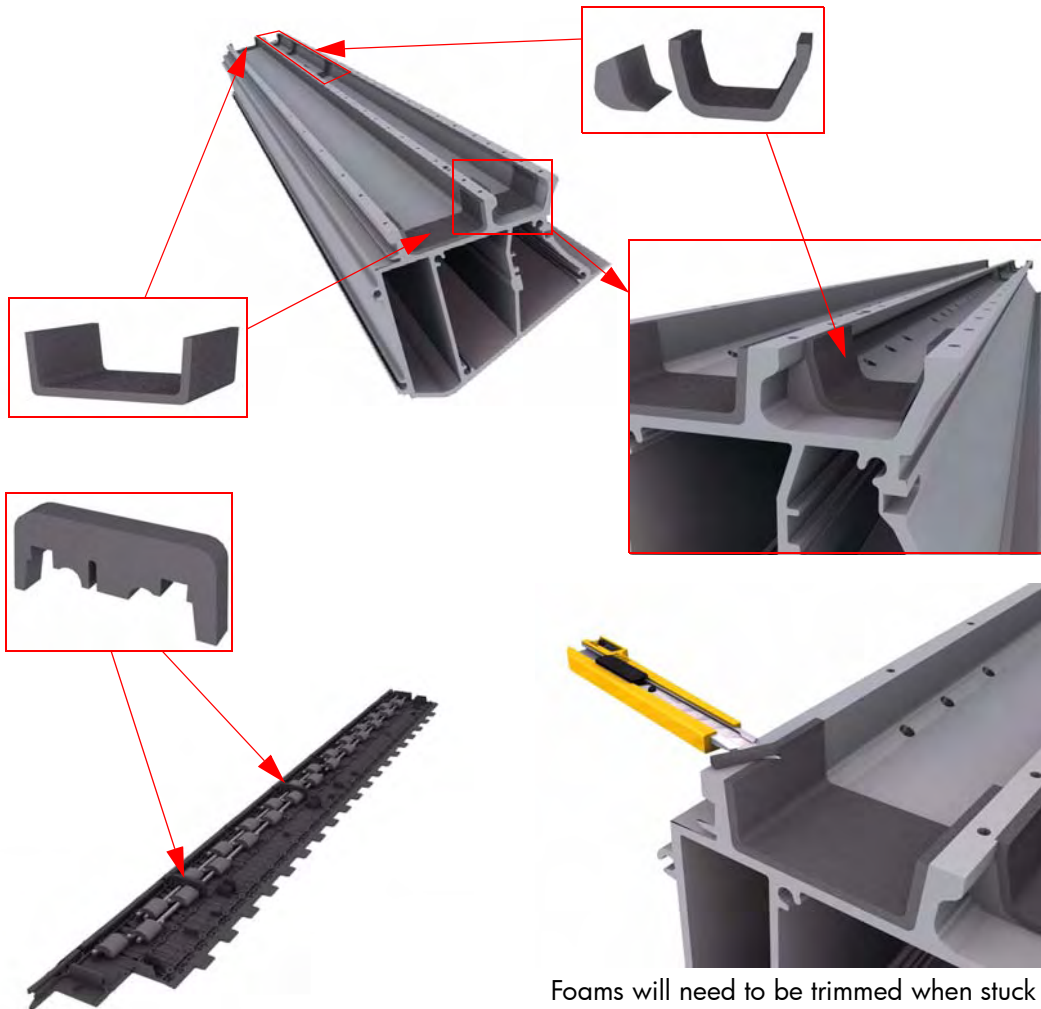

Foams will need to be trimmed when stuck to the Vacuum Beam

## Cartridge Trays

### Removal

Switch off the product and remove the power cable.



1. Open the Ink Cartridge Door.

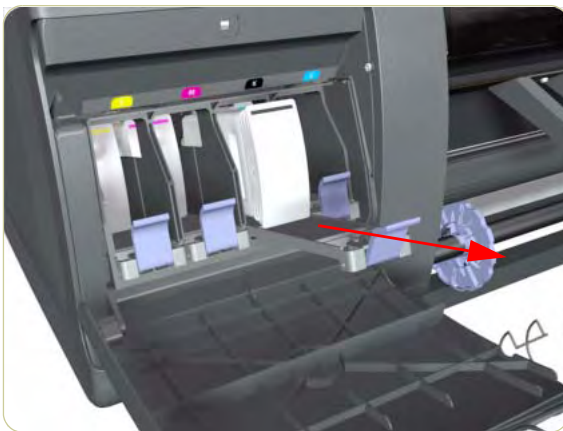

2. Release the Tray Lever of the required color and pull out the Tray. Remove the Ink Cartridge if installed.

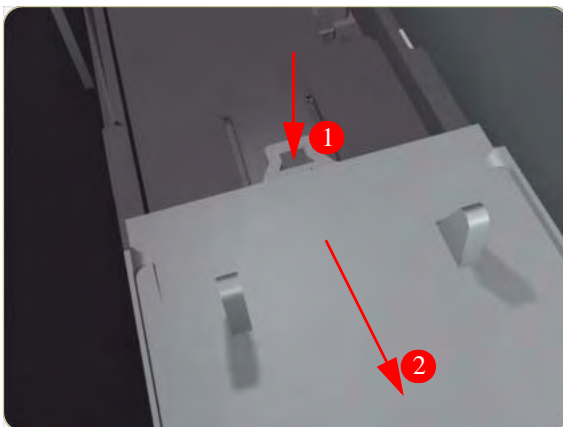

3. Press down on the Tray clip and pull the Tray completely out of the Printer.

**Note that each Cartridge Tray is different even though they look very similar. When selecting the Cartridge Tray from the Support Part (it contains four Cartridge Trays), choose the Tray that exactly matches the one that you have just removed.**

## Input Roller

### Removal

Switch off the product and remove the power cable.

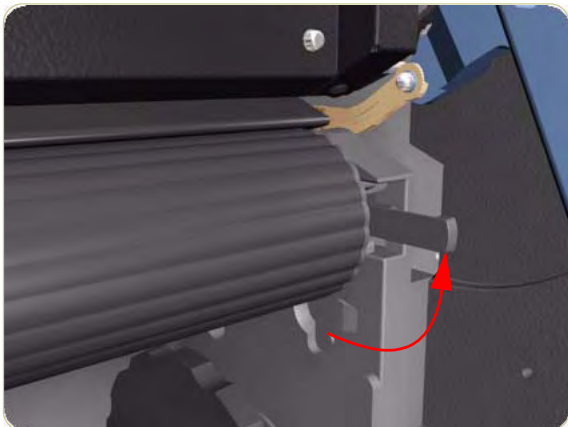

1. Raise the left and right levers to release the Input Roller.

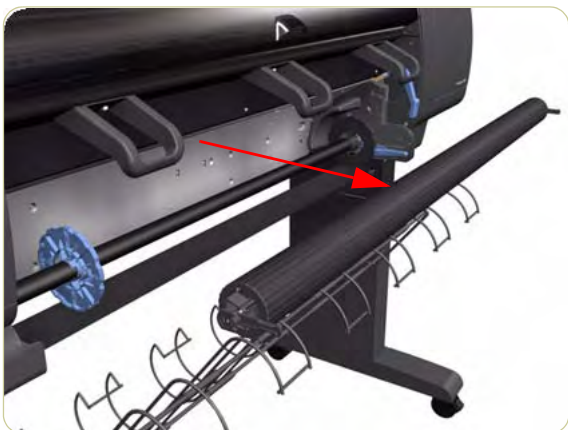

2. Pull out the Input Roller from the Printer.

## Push-Push Mechanism

### Removal

**Switch off the product and remove the power cable.**

1. Remove the Right Cover ⇒ Page 8-4 or the Left Cover ⇒ Page 8-4 depending on which Push-Push Mechanism you want to replace.
2. Open the Ink Cartridge or the Printhead Cleaner Door (depending on which cover you have removed).

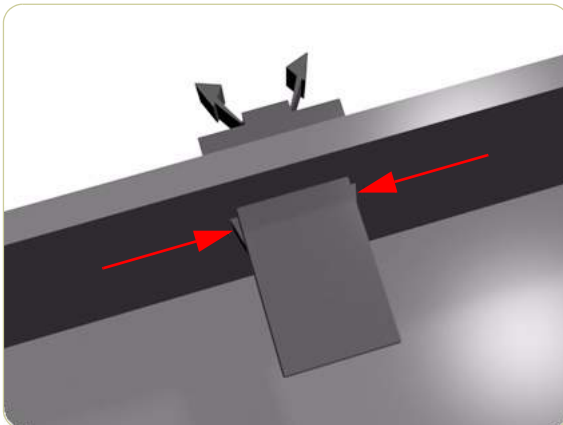

3. Squeeze the release clips from inside the Cover.

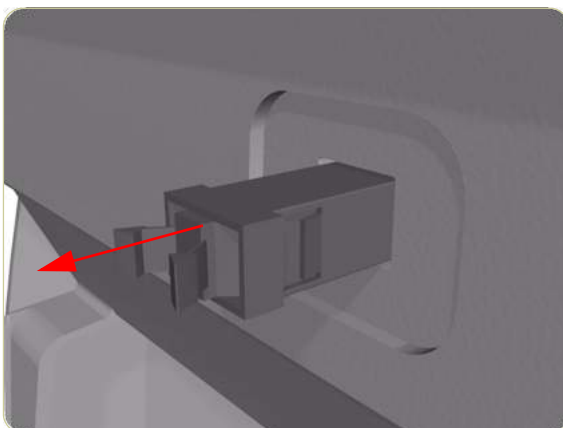

4. Push the Push-Push Mechanism through the hole to remove.

## Media Sensor

### Removal

**Switch off the product and remove the power cable.**

1. Remove the Rear Door ⇒ Page 8-16.
2. Remove the Right Connector Cover ⇒ Page 8-18.
3. Disconnect the Media Sensor cable from the Interconnect PCA.

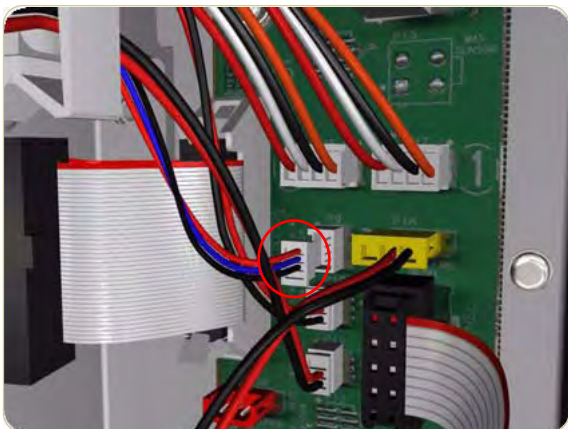

4. Release the Media Sensor cable from the clip located on the Electronics Module.

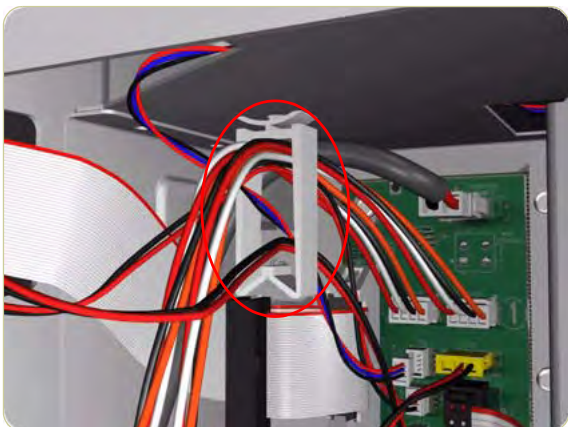

5. Unclip the Media Sensor from the Center Guide.

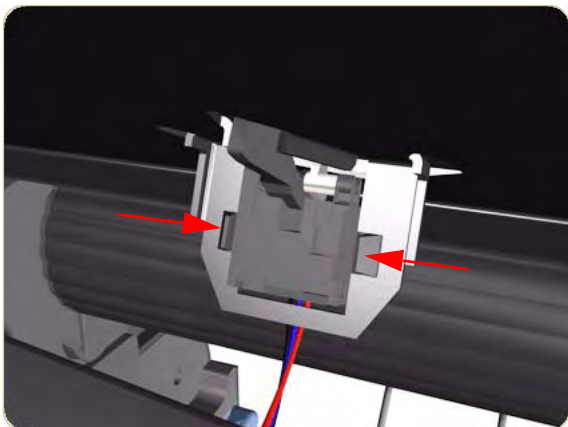

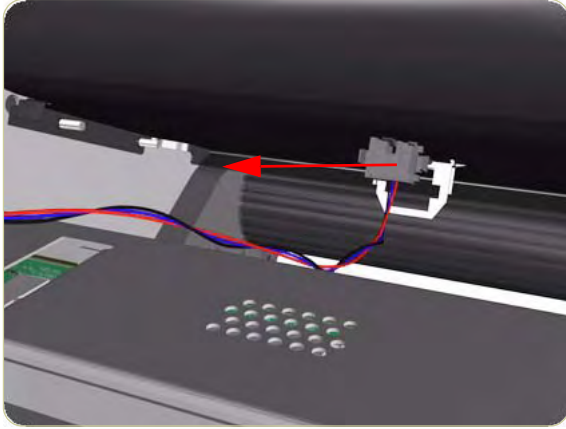

6. Pull the cable through the hole and remove the Media Sensor from the Printer.



## Encoder Disc and Sensor

### Removal

**Switch off the product and remove the power cable.**

**Please handle the Encoder Disc very carefully since any finger prints, scratches or stains could cause the Printer to malfunction.**

1. Remove the Left Cover ⇒ Page 8-9.
2. Remove the Rear Door ⇒ Page 8-16.
3. Remove the Left Connector Cover ⇒ Page 8-19.
4. Remove the Ink Supply Station ⇒ Page 8-40.
5. Disconnect the Encoder Sensor cable from the PrintMech PCA.

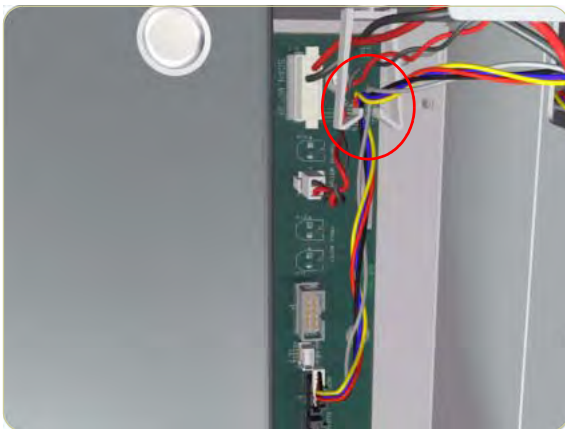
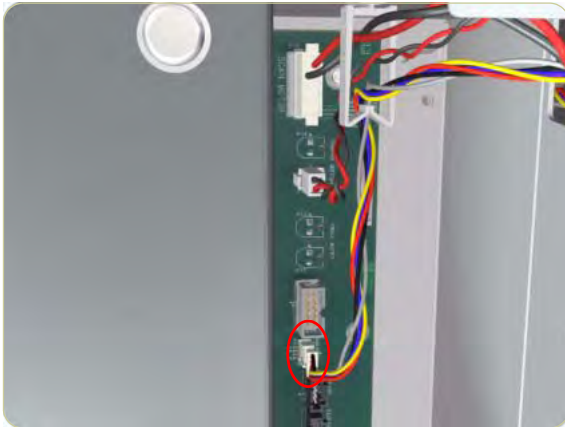

6. Release the Encoder Sensor cable from the clip located on the Electronics Module.



7. Release the Encoder Sensor cable from the clip located on the Encoder Disc Cover.

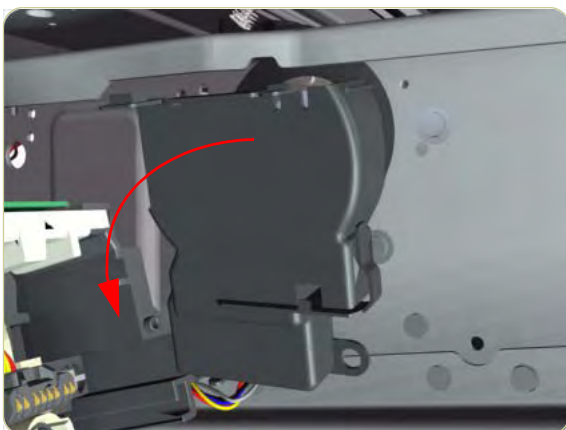

8. Unclip the Encoder Disc Cover and remove from the Printer.

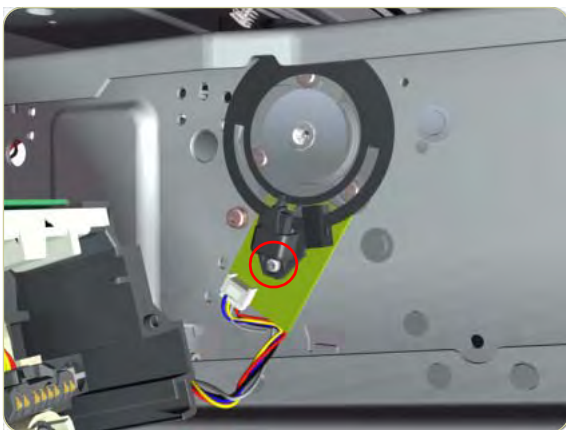

9. Remove one T-8 screw (**Type D**) that secures the Encoder Sensor to the Chassis.



**10.** Remove the Encoder Sensor from the Printer.

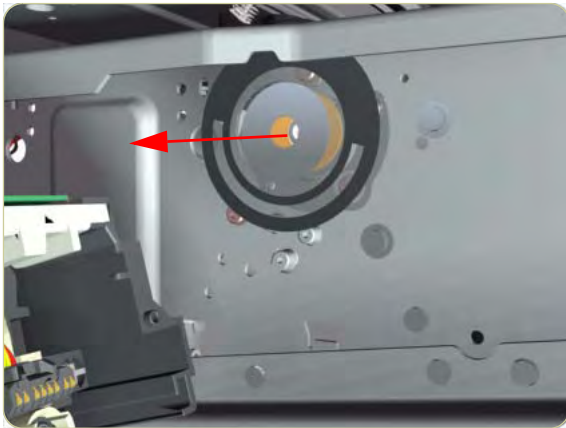

**11.** Carefully peel the Encoder Disc from the Drive Roller.

## Media Lever Assembly

### Removal

Switch off the product and remove the power cable.

1. Remove the Right Cover ⇒ Page 8-6.
2. Remove the Rear Door ⇒ Page 8-16.
3. Raise the Media Lever.



4. Remove one T-15 screw (**Type F**) that secures the Media Lever to the Linkage.

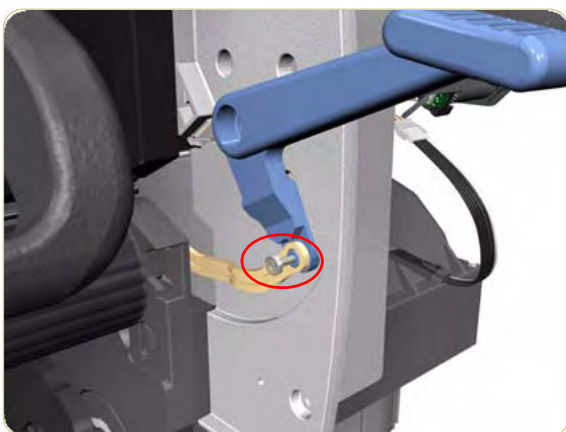

5. Remove one T-15 screw (**Type F**) that secures the Linkage to the Spring.



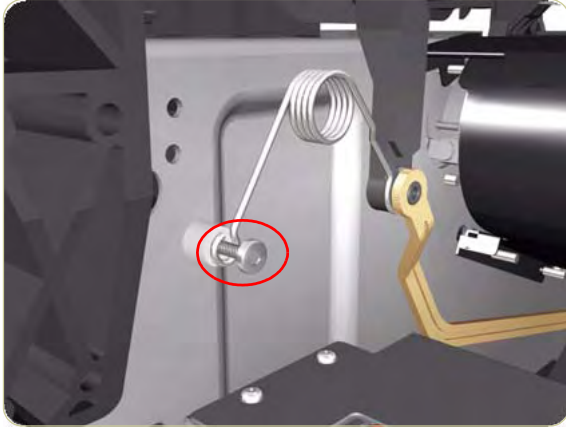

6. Remove one T-20 screw (**Type A**) that secures the Spring to the Spacer.

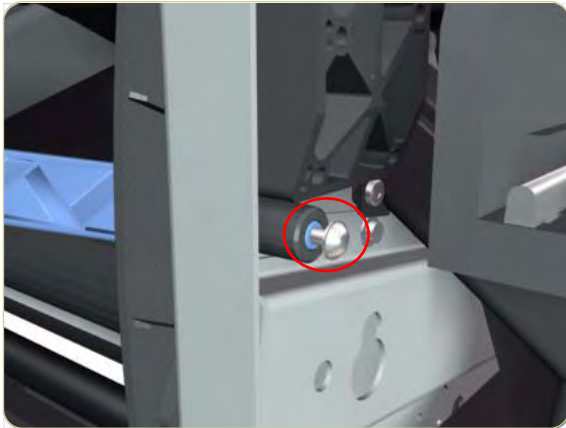

7. Remove one T-20 screw (**Type O**) that secures the Media Lever to the Right Trim.

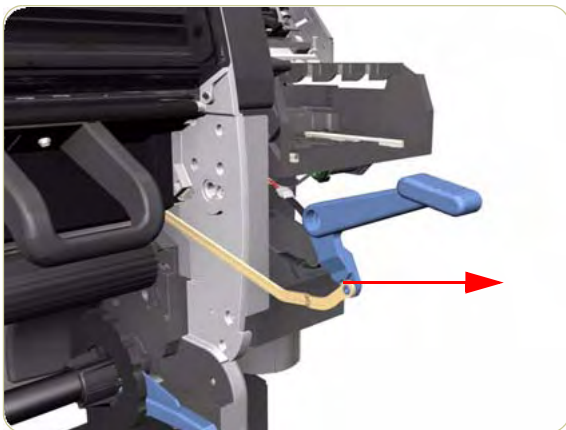

8. Remove the Media Lever Assembly from the Printer.

## Media Lever Sensor

### Removal

Switch off the product and remove the power cable.

1. Remove the Right Cover ⇒ Page 8-6.
2. Remove the Rear Door ⇒ Page 8-16.
3. Remove the Right Connector Cover ⇒ Page 8-18.
4. Remove the Service Station ⇒ Page 8-23.
5. Remove the Front Platen ⇒ Page 8-92.
6. Remove the Media Lever and Linkage ⇒ Page 8-106.
7. Disconnect the Media Lever Sensor cable from the Interconnect PCA.

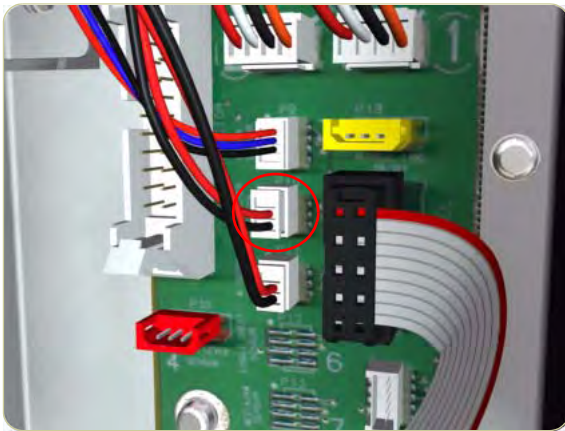

8. Remove five T-15 screws (**Type B**) that secure the Right Trim.

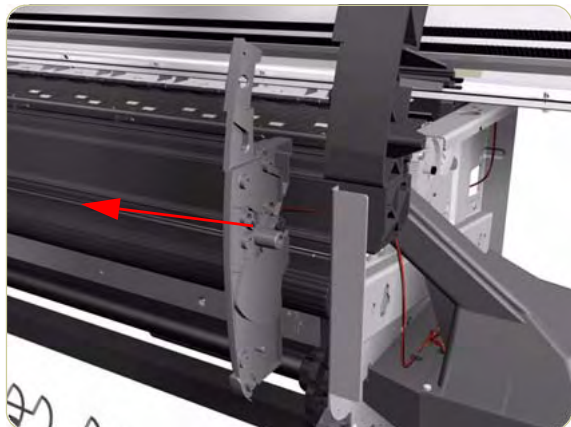

- 9.** Carefully remove the Right Trim from the Printer.

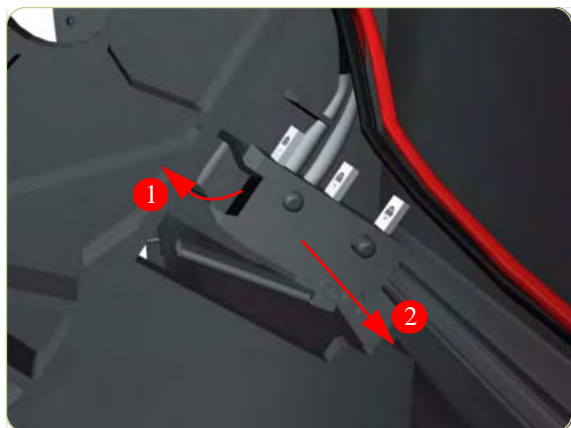

- 10.** Carefully release the clip securing the Media Lever Sensor from the Right Trim and remove from the locating pins.



- 11.** Release the Media Lever Sensor Cable from the four clips on the Vacuum Fan.

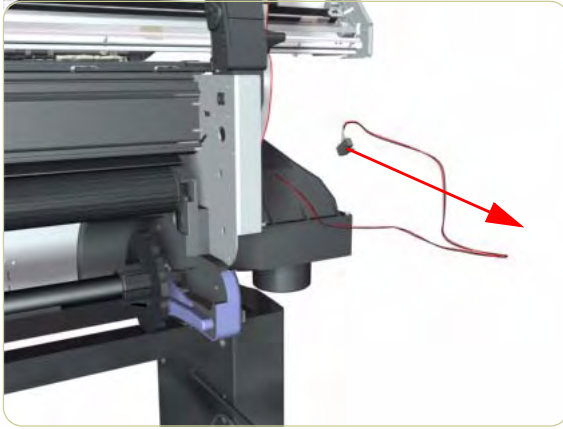

**12.** Remove the Media Lever Sensor from the Printer.



## Pinchwheel Assembly

### Removal

**Switch off the product and remove the power cable.**

1. Remove the Right Cover ⇒ Page 8-6.
2. Remove the Rear Door ⇒ Page 8-16.
3. Remove the Service Station ⇒ Page 8-23.
4. Remove one T-20 screw that secures the Linkage to the Spring.

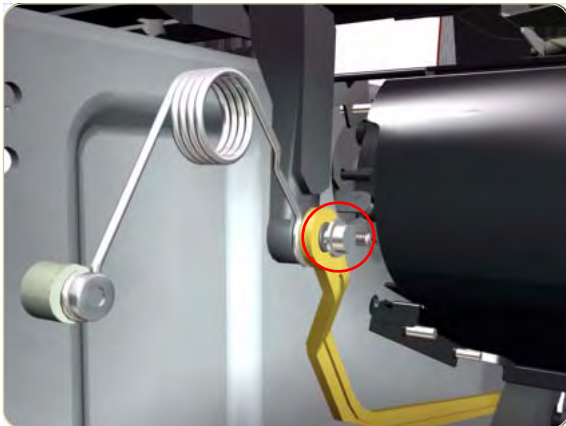

5. Remove one T-20 screw that secures the Cam to the Cam Lever.

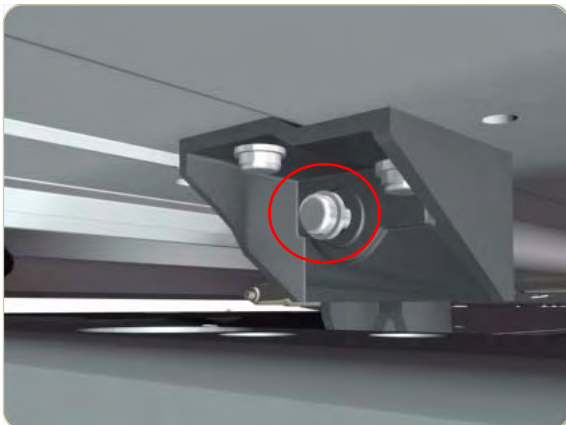

6. Insert a plastic stud in to each Pinchwheel Subassembly (the Plastic Studs can be found in the replacement Pinchwheel Assembly kit).



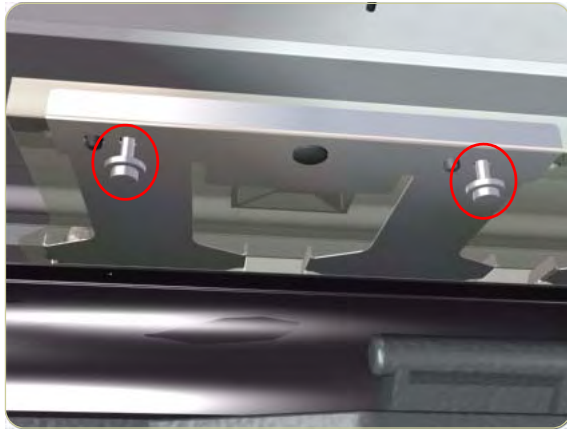

7. Remove two T-20 screws (**Type M**) from each Pinchwheel Subassembly (a 90 degree angle screwdriver is included with the replacement Pinchwheel Assembly).

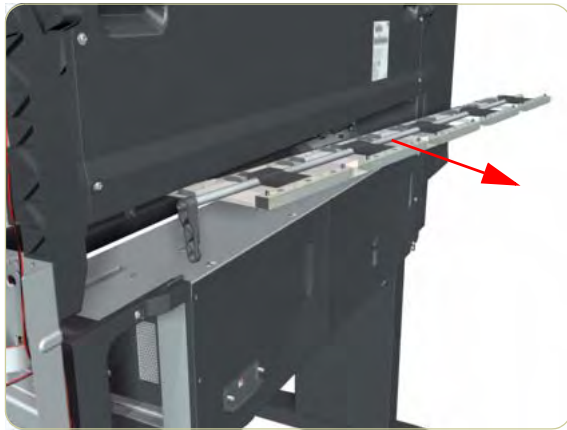

8. Remove the complete Pinchwheel Assembly (including the Cam and Cam Lever) from the Printer.



**Before installing the NEW Pinchwheel Assembly, insert the plastic studs in to each Pinchwheel subassembly. This will make it easier to install the complete Pinchwheel Assembly.**

## Removing individual Pinchwheels



1. To remove an individual Pinchwheel, push apart the metal part that secures the pinchwheels and then pull out the individual Pinchwheel.

## Important Information on Installation of Pinchwheels

The Pinchwheel Assembly contains 3 white Pinchwheels and several black Pinchwheels. The black Pinchwheels are symmetrical so can be installed without any problems, BUT the white Pinchwheels are NOT symmetrical so it is VERY IMPORTANT to install them correctly using the following illustration:

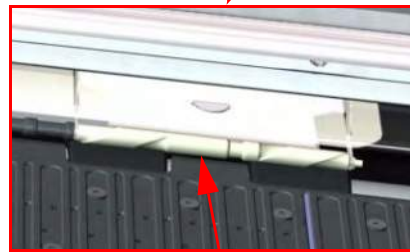

**Check the orientation of the Pinchwheel before installing**

## Center Guide

### Removal

**Switch off the product and remove the power cable.**

1. Remove the Right Cover ⇒ Page 8-6.
2. Remove the Left Cover ⇒ Page 8-9.
3. Remove the Right Connector Cover ⇒ Page 8-18.
4. Remove the Left Connector Cover ⇒ Page 8-19.
5. Remove the Service Station ⇒ Page 8-23.
6. Remove the Ink Supply Station ⇒ Page 8-40.
7. Remove the Media Sensor ⇒ Page 8-108.
8. Disconnect ALL the cables connected to the Interconnect PCA and the Gamut PCI PCA.

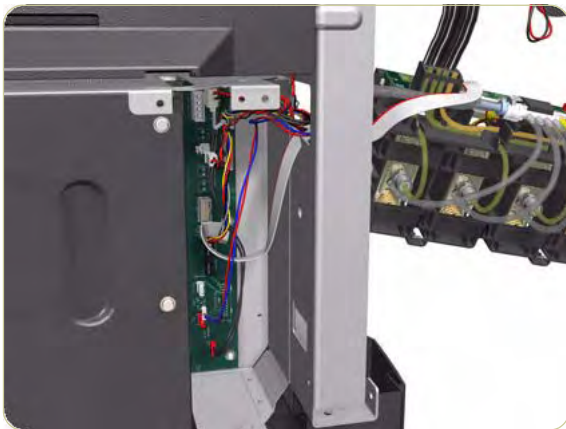
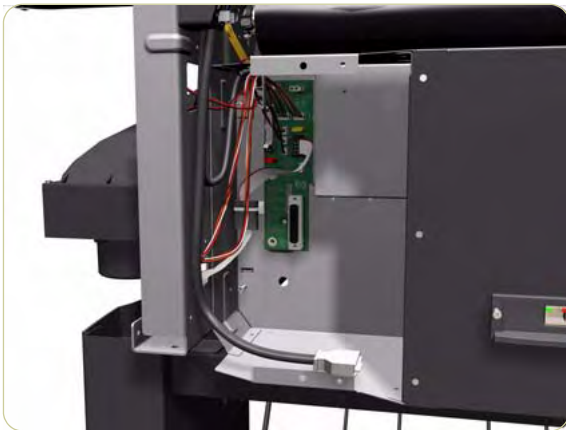

9. Disconnect ALL the cables connected to the PrintMech PCA.



**10.** Remove four T-20 screws (**Type B**) that secure the Electronics Module.

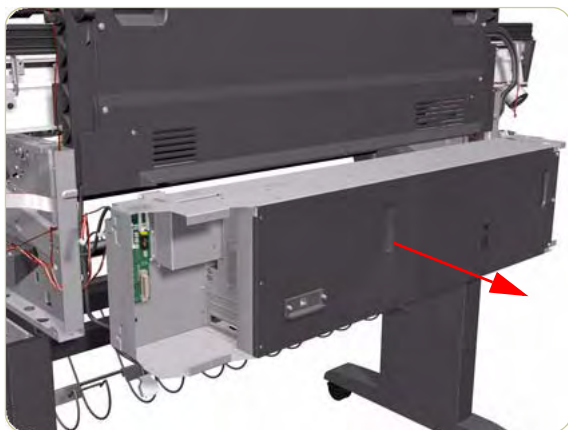

**11.** Remove the Electronics Module from the Printer.

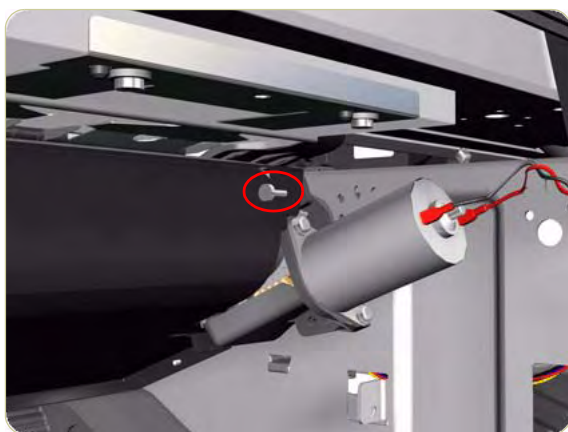

**12.** Remove one T-15 screw (**Type E**), that secures the Center Guide, from underneath the Printer.

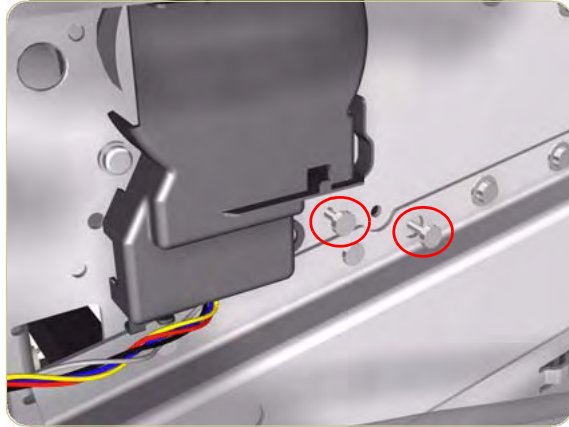

**13.** Remove two T-15 screws (**Type E**), that secure the Center Guide, from the left hand side of the Printer.

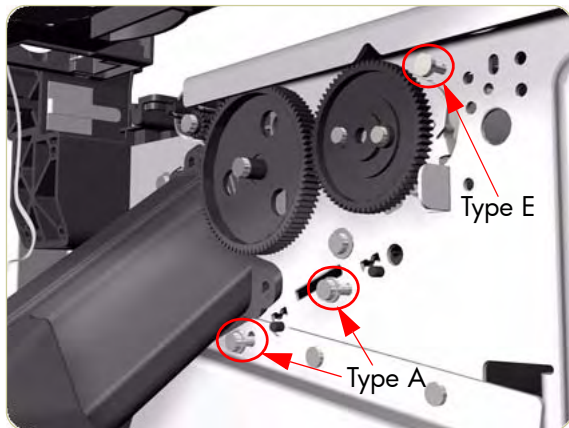

**14.** Remove one T-15 screw (**Type E**) and two T-20 screws (**Type A**), that secure the Center Guide, from the right hand side of the Printer.

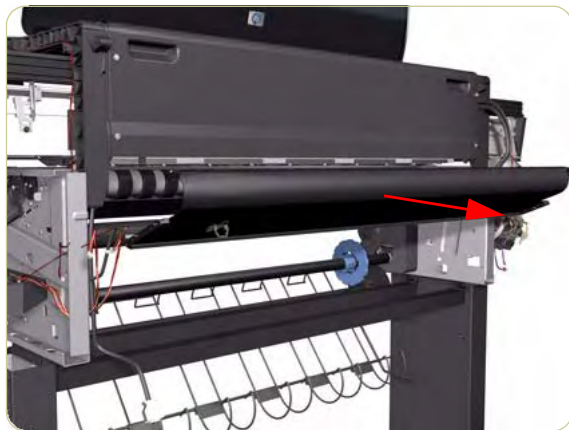

**15.** Remove the Center Guide from the Printer.

## Drive Roller

### Removal

**Switch off the product and remove the power cable.**

1. Remove the Right Cover ⇒ Page 8-6.
2. Remove the Left Cover ⇒ Page 8-9.
3. Remove the Right Connector Cover ⇒ Page 8-18.
4. Remove the Left Connector Cover ⇒ Page 8-19.
5. Remove the Service Station ⇒ Page 8-23.
6. Remove the Ink Supply Station ⇒ Page 8-40.
7. Remove the Media-Axis Motor ⇒ Page 8-62.
8. Remove the Encoder Disc and Sensor ⇒ Page 8-103.
9. Remove the Media Lever Assembly ⇒ Page 8-106.
10. Remove the Media Sensor ⇒ Page 8-108.
11. Remove the Center Guide ⇒ Page 8-115.
12. Remove two T-10 screws that secure the Drive Roller Gear.

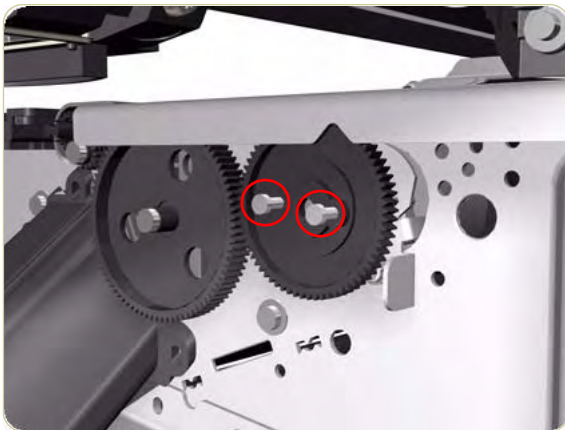



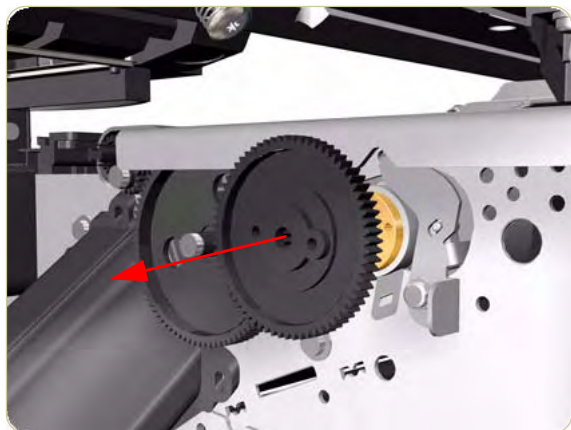

**13.** Remove the Drive Roller Gear from the Printer.

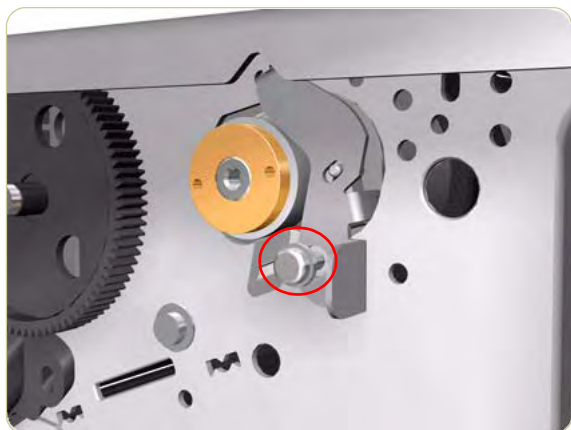

**14.** Remove one T-20 screw (**Type B**) that secures the cover on the right hand side of the Printer.

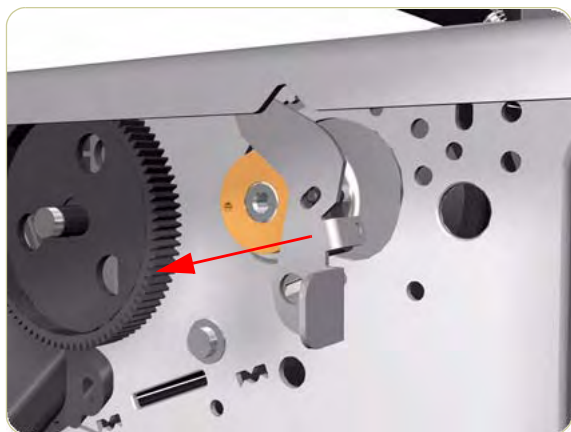

**15.** Remove the Cover.



**16.** Remove two T-20 screws (**Type B**) that secure the cover on the left hand side of the Printer.

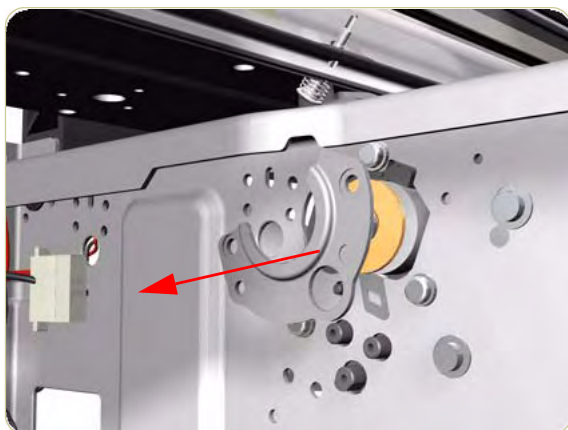

**17.** Remove the Cover.



**18.** Remove three T-20 screws (**Type B**) that secure the Media-Axis Motor Bracket to the sideplate.

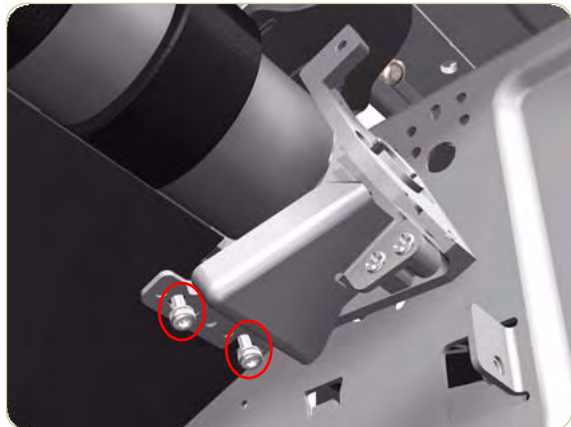

**19.** Remove two T-20 screws (**Type A**) that secure the Media-Axis Motor Bracket to the Chassis.

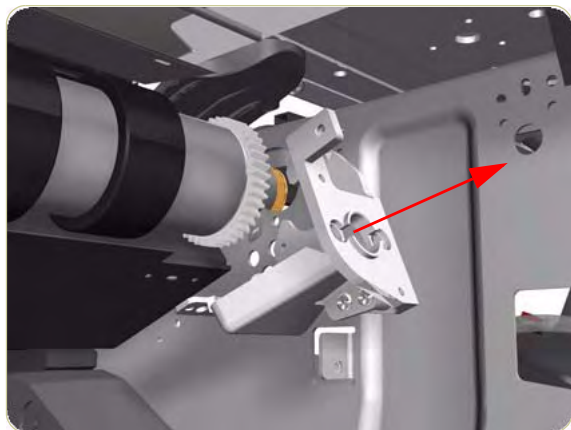

**20.** Remove the Media-Axis Motor Bracket from the Printer.



**21.** Remove the Drive Roller by sliding it to the right, then downwards and then out of the Printer.

**When reinstalling the parts, make sure you apply the grease (included with the support part) to the gears.**

**After installing the NEW Drive Roller, make sure you perform the following Service Calibration:**

- Paper Advance Calibration ⇒ Chapter 5.

## Installation of the Drive Roller

When installing the Drive Roller, several different datums have to be met in order to ensure that the Drive Roller has no axial play. Use the following illustrations to ensure that ALL the datums are met:

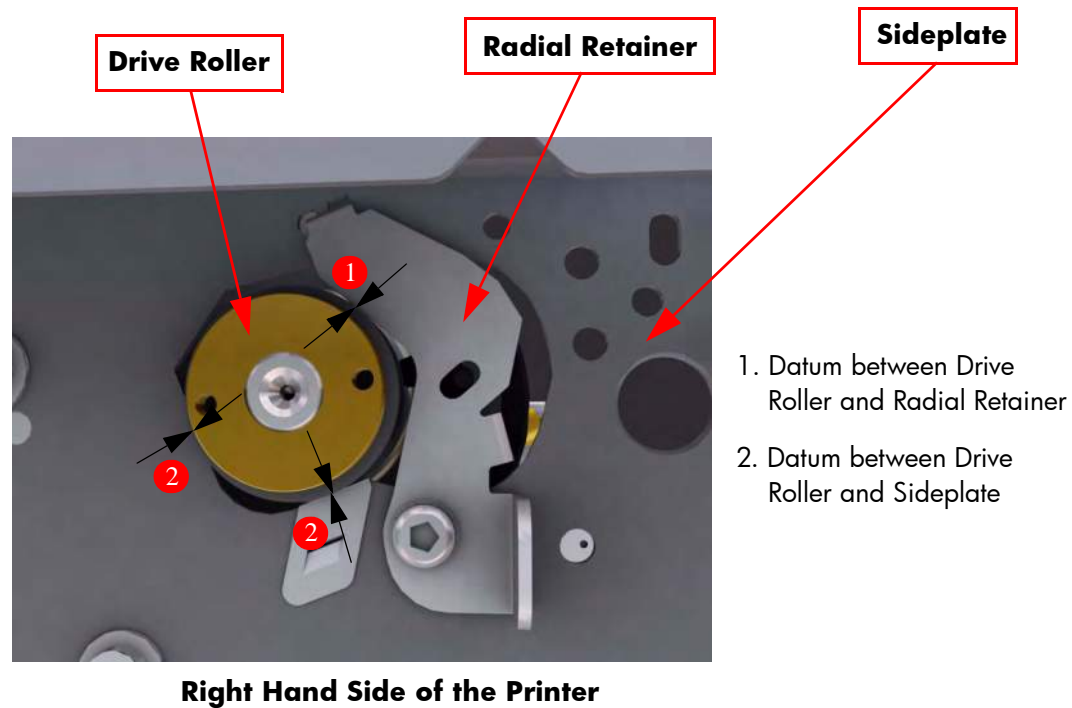
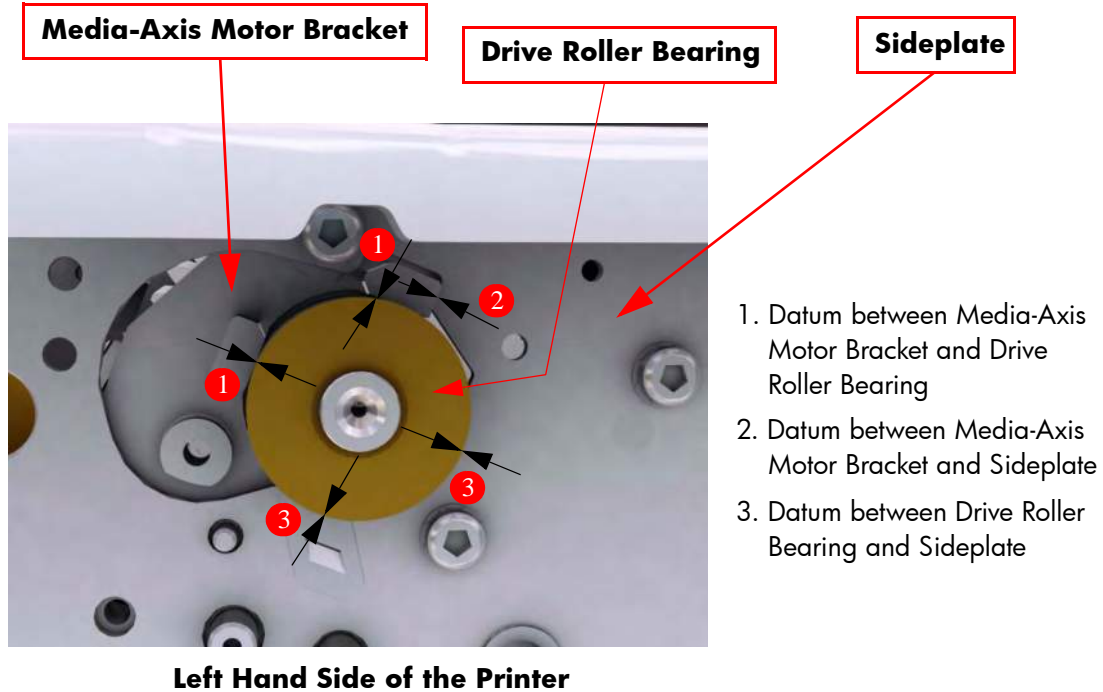

To make sure that ALL the datums are met when installing the Media-Axis Motor Bracket, make sure you follow these instructions:

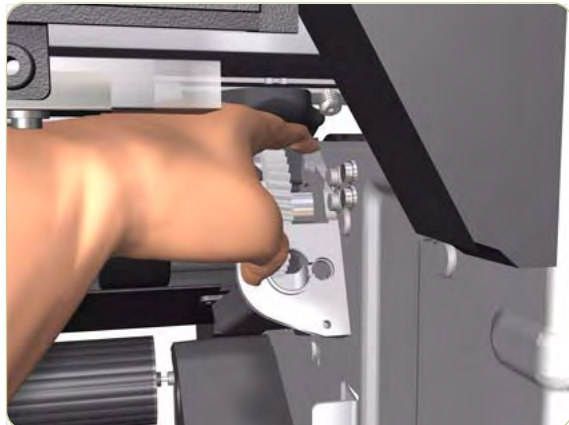

1. Place the Media-Axis Motor Bracket in the correct position on the Printer. Make sure you keep it pushed down (as shown in the illustration) until the first screw has been installed and fully tightened.

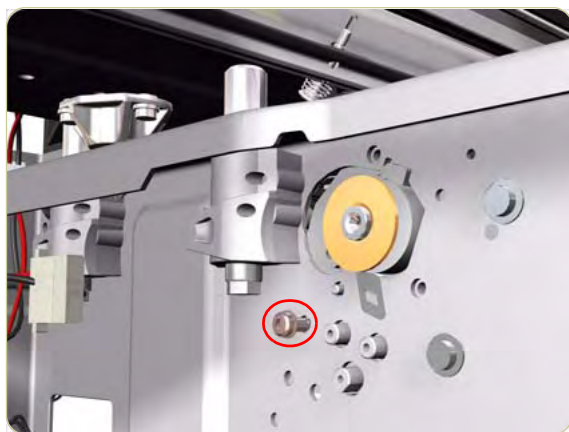

2. Install the first screw (T-15) in the position shown. Make sure you tighten the screw fully so that the Media-Axis Motor Bracket cannot be moved.

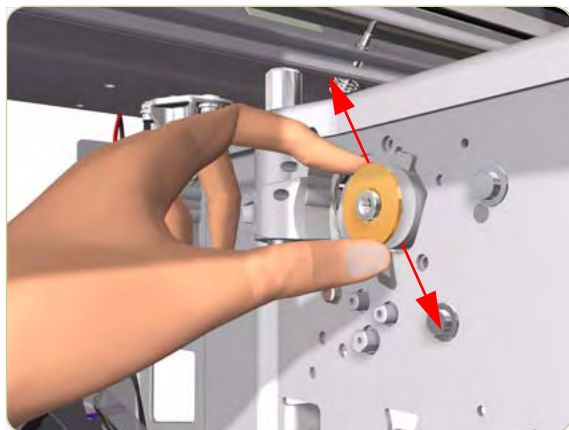

3. Check that there is no play (movement) between the Media-Axis Motor Bracket and the Drive Roller. If there is play, then check that the screw installed in the previous step is fully tightened.

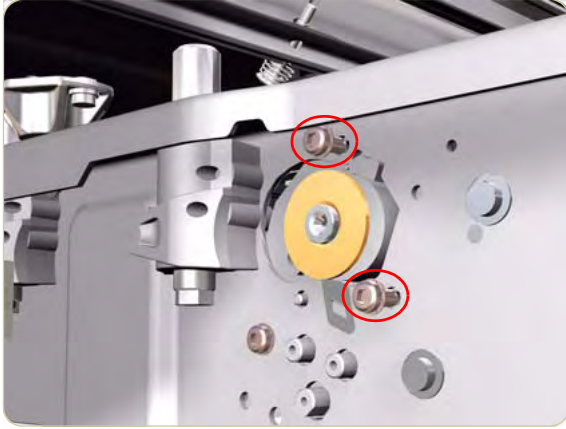

4. Install the remaining two screws (T-15) that secure the Media-Axis Motor Bracket.

## Right Rollfeed Module Assembly

### Removal

**Switch off the product and remove the power cable.**

1. Remove the Right Cover ⇒ Page 8-6.
2. Remove the Service Station ⇒ Page 8-23.
3. Remove the Vacuum Fan ⇒ Page 8-27.
4. Remove the Input Roller ⇒ Page 8-99.
5. Remove the Media Spindle (if installed).
6. Remove one T-15 screw (**Type B**) that secures the Right Rollfeed Module from the inside.

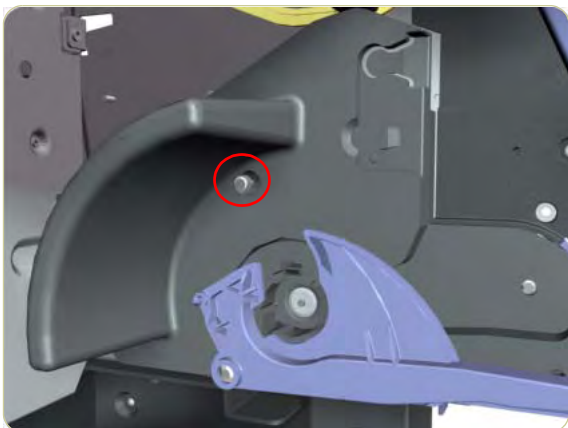

7. Remove one T-20 screw (**Type B**), one T-15 screw (**Type G**) and two T-15 screws (**Type J**) that secure the Right Rollfeed Module from the outside.

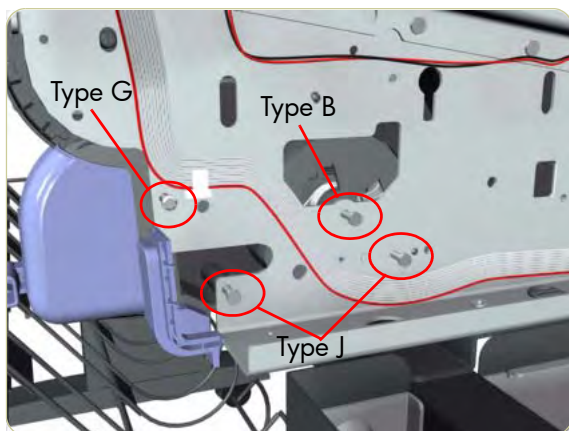

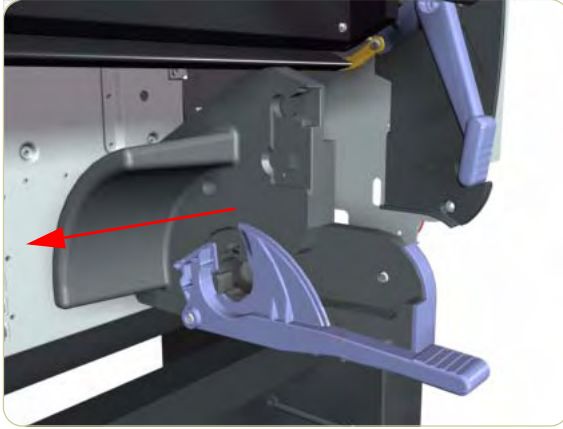

8. Remove the Right Rollfeed Module from the Printer.

## Installation

**Follow these instructions for the correct installation of a NEW Right Rollfeed Module Assembly:**



1. Hold the Right Rollfeed Module as shown, keeping your thumb firmly on the Media Tension Mechanism.

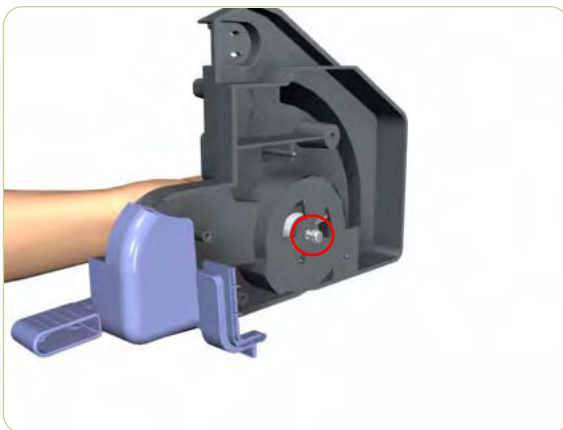

2. While securely holding the Right Rollfeed Module, remove the T-15 screw that secures the Media Tension Mechanism.



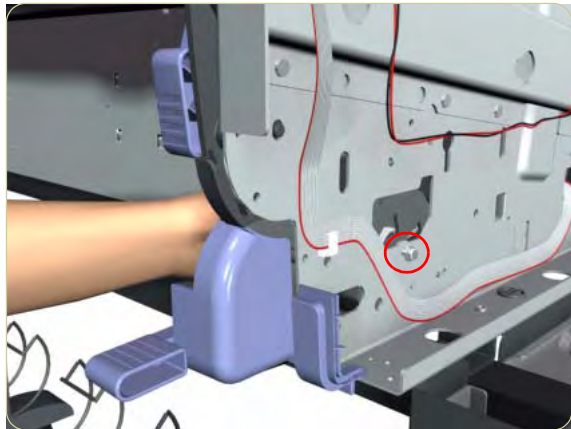

- 3.** While securely holding the Right Rollfeed Module, position the Right Rollfeed on to the Printer and install the T-15 screw that was removed in the previous step.
- 4.** Install the remaining screws that were removed during the removal process.

## Right Spindle Lever

### Removal

These instructions explain how to remove a broken Spindle Lever and install a new one.

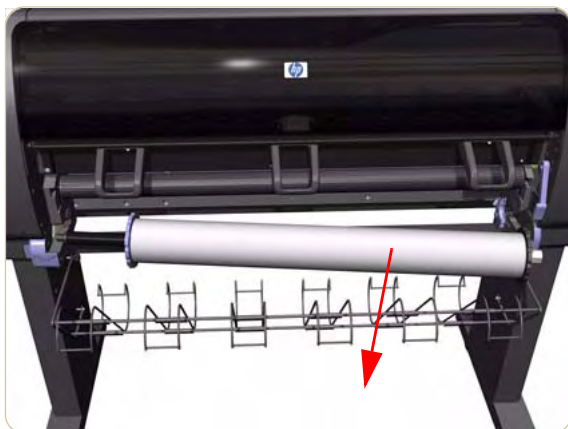

1. Pull out the Media Spindle from the Printer.

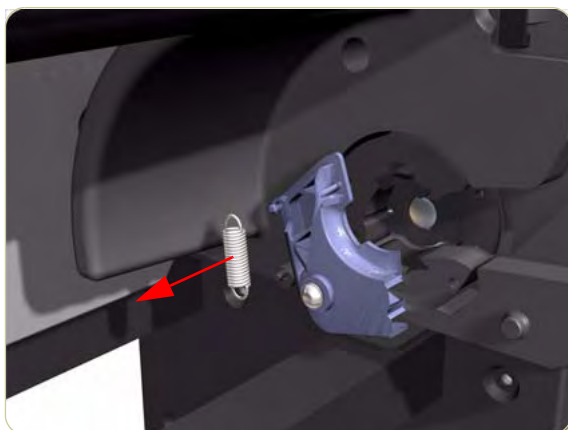

2. Remove the Spring from the Spindle Lever.

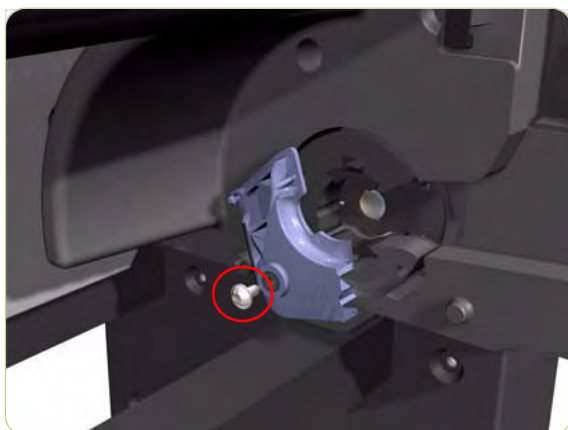

3. Remove one T-20 screw (**Type O**) that secures the Spindle Lever.

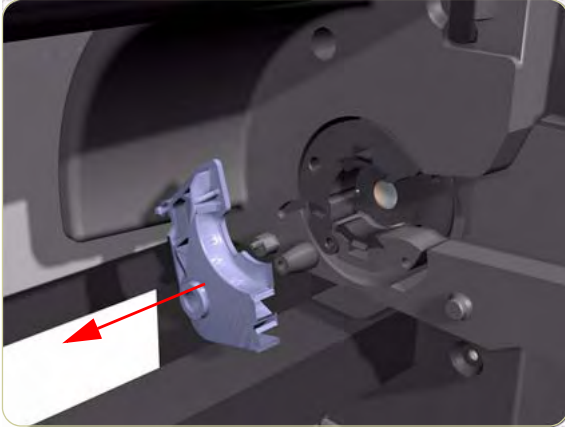

4. Remove the Spindle Lever.

## Installation

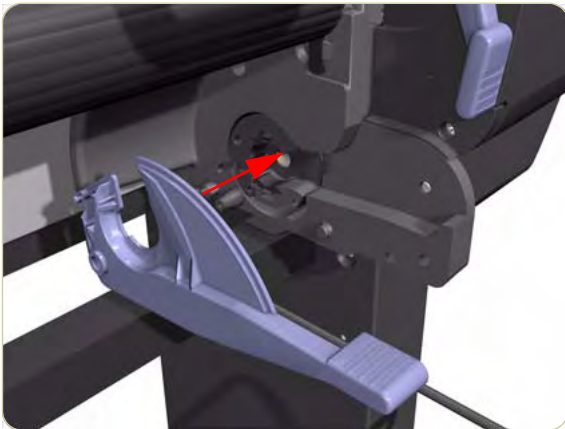

1. Position the new Spindle Lever on the Printer.

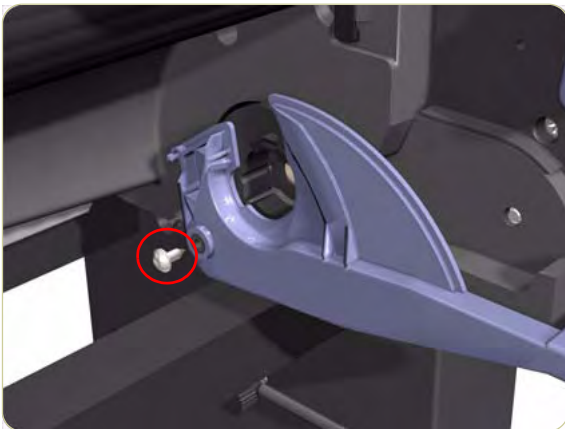

2. Install one T-20 screw (**Type O**) to secure the Spindle Lever.

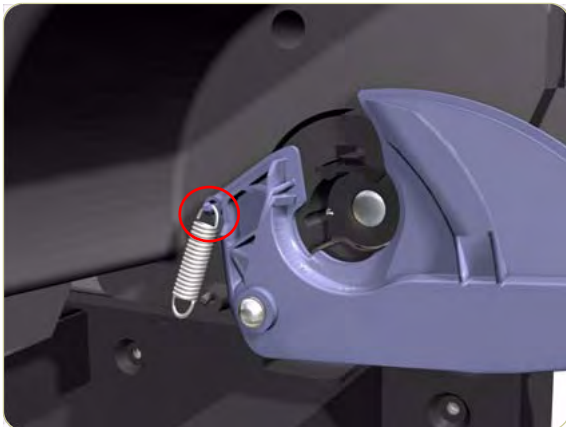

**3.** Place the spring on the top hook.

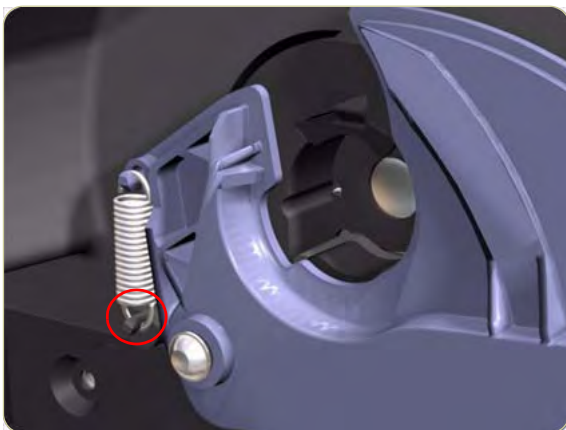

**4.** Stretch the spring and loop the spring on the bottom hook.

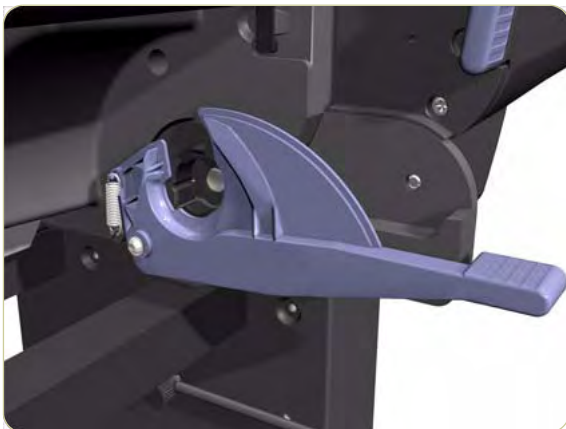

**5.** Check that the Spindle Lever is installed correctly as shown here.

# Preventive Maintenance

# 9

Moisture on the Printer 9-2  
Noisy Carriage Bushing 9-2  
Belt Swelling 9-2  
Cleaning the Printer 9-2  
General Cleaning 9-2  
Cleaning the Drive Roller and Overdrive 9-3  
Cleaning the Center Platen 9-3  
Applying Oil to the Overdrive 9-5  
Lubricating the Carriage Assembly 9-5  
Scheduled Maintenance 9-6  
Level of Printer Usage 9-6

## Preventive Maintenance

### Moisture on the Printer

Users should use the Printer in an environment between 20% and 80% relative humidity. To recover from moisture condensation, turn the Printer Off, and, using the main roller as a reference, wait until the Printer is completely dry before using it again.

### Noisy Carriage Bushing

To prevent noisy movement of the carriage, remove aluminum or dust particles from the bushing at the back of the carriage, and from the slider path along which the bushing moves.

### Belt Swelling

To prevent new belts from swelling incorrectly, keep them in their bags with dessicant until you need to install them.

### Cleaning the Printer

To maintain the Printer in good operating condition, keep it free of dust accumulation, ink, and other contamination. Cleaning intervals are determined by the Printer environment and by the types of Printer supplies used.

### General Cleaning

Proper general cleaning should include the following:

**To prevent an electric shock, make sure that the Printer is switched OFF and unplugged before any cleaning is performed. Do NOT let any water get inside the Printer.**

- 1 Blow away dust accumulation with compressed air if available.
- 2 Clean the outer surface of the Printer with a damp sponge or cloth. Use a mild soap and water solution if necessary. Do not use abrasive cleaners.
- 3 Wipe the Printer dry with a soft lint-free cloth.

## Cleaning the Drive Roller and Overdrive

**If ink is spilled on the Overdrive, remove the ink immediately. Due to the ink's reflectance, ink on the Overdrive can disrupt the Printer's edge-sensing function. To remove any ink from the Overdrive, perform the following procedure:**

**Prevent water or other liquids from running onto electrical components or circuits, or through openings in the Electronics Module.**

- 1 Perform the Turn Drive Roller Utility (Refer to Page 4-63).
- 2 Open the window and apply any common household cleaning solution (water based only) to a soft, lint-free rag and apply it to the Drive Roller and Overdrive surface while it is rotating. Make sure that you thoroughly clean the Drive Roller and Overdrive surface.
- 3 Press **Enter** when you have completed the cleaning procedure.
- 4 Allow the Drive Roller to dry before loading media in to the Printer.

## Cleaning the Center Platen

**If wide paper is used to print after narrower paper is used for some time, you may find that the left hand side of the Center Platen has become dirty and will leave marks on the back of the paper if not cleaned.**

It is recommended to clean the Center Platen on a regular basis (at least every few months or when required) as follows:

- 1 Unload any media loaded from the Printer.
- 2 Open the Window and with a dry brush remove ink deposits from the Cutter Groove and the Center Platen surface.

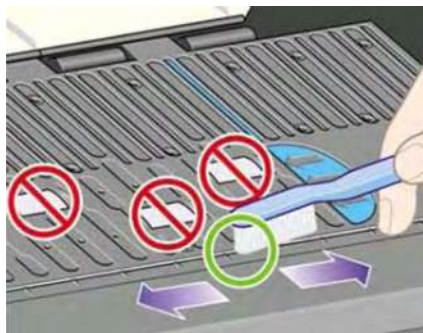

Cutter Groove

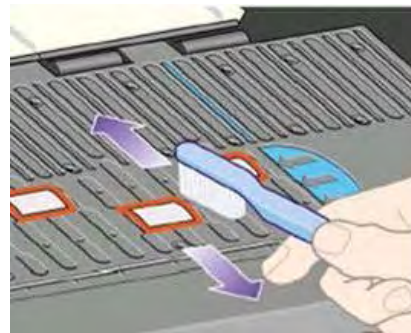

Center Platen Surface

- 3** Use a clean, absorbent lint-free cloth, dampened with Isopropyl Alcohol (not supplied in the Maintenance Kit), to wipe loosened ink deposits from the Center Platen.

- **Do NOT use commercial cleaners or abrasive cleaners.**
- **Do NOT wet the Center Platen directly because you will leave too much moisture behind.**
- **Do NOT wet the rubber wheels at all (not even with the cloth).**

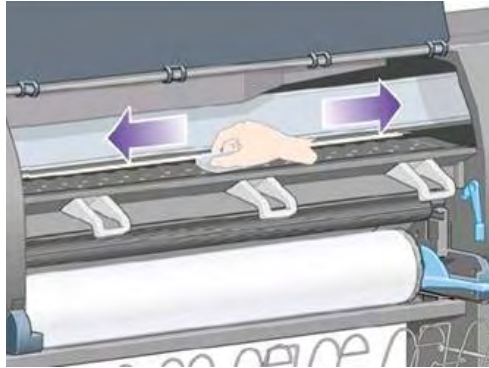

- 4** Clean the Cutter ramp with the damp cloth.

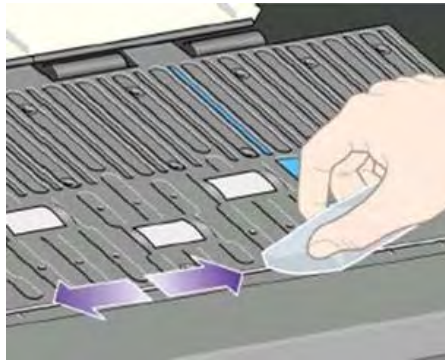

- 5** Clean the exposed part of the wheels with a dry cloth. Ideally, clean the whole circumference of these wheels (you can use Turn Drive Roller Utility on Page 4-63).

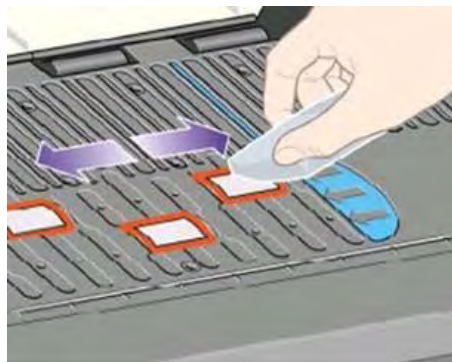



## Applying Oil to the Overdrive

Occasionally, it may be necessary to oil the Overdrive in order to stop the rollers from squeaking:

- 1 Open the Window.
- 2 There are small holes in the Center Platen beside some of the rollers.
- 3 A bottle of oil is supplied with the Maintenance Kit. Insert the pointed end of the bottle into each hole in turn, and put three drops into each.
- 4 Be very careful not to spill any oil onto the Center Platen.
- 5 If there is oil on the Center Platen, wipe it away with the cloth supplied with the Maintenance Kit.
- 6 Close the Window.

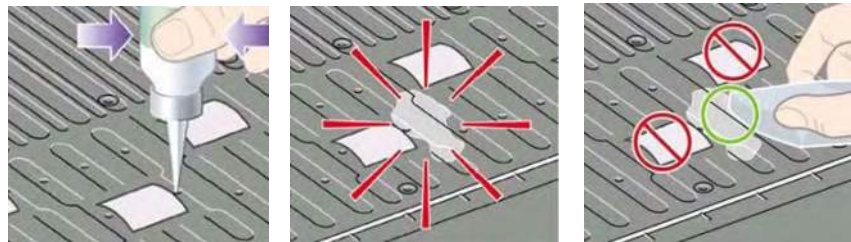

## Lubricating the Carriage Assembly

The Carriage Assembly needs to be lubricated occasionally (at least once a year) so that it can slide easily along the Slider Rod.

- 1 Using the Front Panel, in the Printheads menu, select "Replace printheads now". The Carriage Assembly will move to the center of the Printer.
- 2 Open the Window and apply a few drops of oil (bottle of oil can be found in the Maintenance Kit) to the pads on either side of the Carriage Assembly.
- 3 Apply a few drops of oil directly to the Slider Rod on either side of the Carriage Assembly.

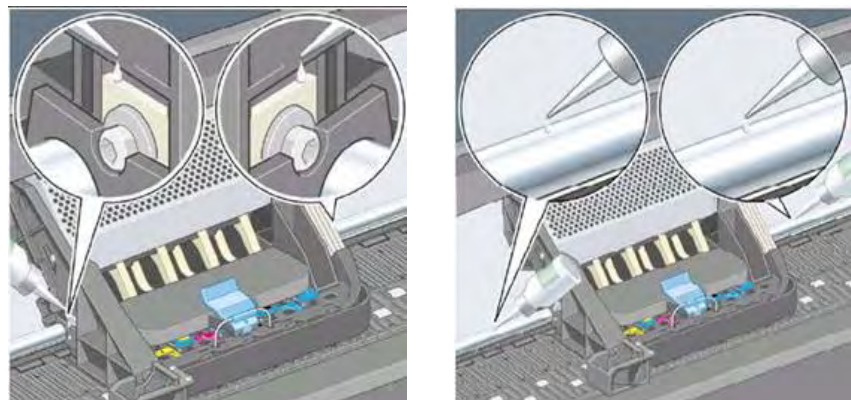

## Scheduled Maintenance

In some segments of the printer market, the customer tends to print more than the maximum number of prints that the throughput allows, exceeding by far the limit of the design. When this happens the customer runs into print quality problems and continuous Printer failures.

The purpose of scheduled preventive maintenance is to avoid these failures - ensuring a good performance during all the product life.

## Level of Printer Usage

Normal printer use means 6,000,000 Carriage Cycles (which corresponds to approximately 100,000 A0 prints on average). Under normal usage conditions, it will be approximately 5 years before the printer needs maintenance. If the printer is used more than the normal usage conditions, then it will need maintenance service much more frequently.

One of the EEROM counters is assigned to counting the number of carriage cycles. When certain components of the Printer exceed this amount, the front panel displays the following message:

### "Maintenance #1 required"

The following message is triggered depending on the total quantity of ink spitted in each Spittoon.

### "Maintenance #2 required"

Once one of the maintenance advised messages is displayed, the preventive maintenance kit must be used to replace the most worn parts of the printer. Use the Removal and Installation Chapter of this Service Manual as a guide to replace the necessary parts.

The following PM Kit covers both Maintenance advised messages:

### **Preventive Maintenance Kit - Part Number Q1273-60061**

This Preventive Maintenance Kit contains the following components:

- Complete Carriage Assembly (⇒ Page 8-53).
- Ink Supply Tubes and Trailing Cable (⇒ Page 8-33).
- Scan-Axis Motor (⇒ Page 8-59).
- Belt Assembly (⇒ Page 8-58).
- Most Left Spittoons (⇒ Page 8-43).
- Middle Left Spittoons (⇒ Page 8-44).
- Scraper (located on the Service Station).

You must also clean the holes in the Service Station which are located under the Black Printhead Cleaners.

**About this Edition**

This is the 2nd edition of this Service Manual

1st edition, titled

**hp** designjet 4000 series printers service manual (models Q1273A/Q1274A) -  
December 2004

2nd edition, titled

**hp** designjet 4000 series printers service manual (models Q1273A/Q1274A) -  
April 2005

## **What's in this Service Manual**

This manual contains information necessary to test, calibrate and service:

- **hp** designjet 4000 (model Q1273A)
- **hp** designjet 4000ps (model Q1274A)

For information about using these printers, refer to the corresponding User and Quick Reference Guides.

The procedures described in this manual are to be performed by HP-qualified Service Personnel only.

